

DUAL 600mA LDO REGULATOR WITH ENABLE FUNCTION

FEATURES

- **Input Voltage Range :**
 Channel 1 : 3.4V to 5.5V
 Channel 2 : 2.8V to 5.5V
- **Low Quiescent Current is 50uA/per channel (typ.)**
- **Tight Load and Line Regulation**
- **Fast Transient Response**
- **Current Limit and Thermal Shutdown Protection**
- **Only low-ESR Ceramic Capacitors Required for Stability**
- **Available in the ESOP-8 Pb-Free Package**

DESCRIPTION

The APE8839A is an efficient, precise dual-channel CMOS LDO regulator optimized for ultra-low-quiescent applications. Regulators output1 and output2 are capable of sourcing 600mA of output current. The regulators are stable with output capacitors as low as 1 μ F, including current limit, thermal shutdown protection, fast transient response, low dropout voltage, high output accuracy, current limiting protection, and high ripple rejection ratio. The APE8839A contains internal pull high enable function that allows the output of each regulator to be turned off independently. The APE8839A regulators are available in used SO-8 with Exposed Pad package.

TYPICAL APPLICATION

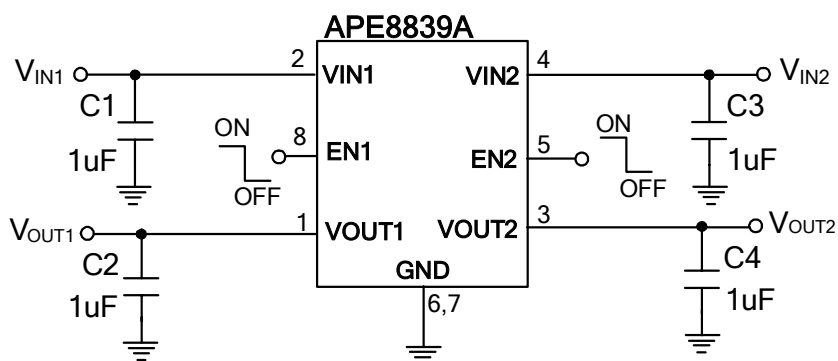

PACKAGE ORDERING INFORMATION

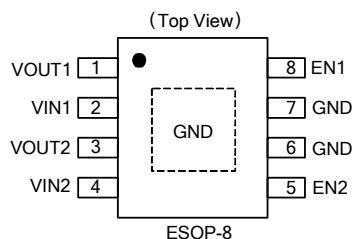
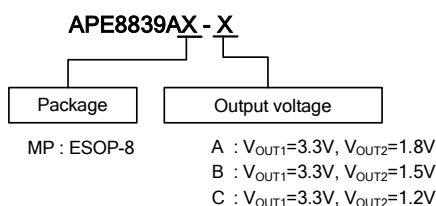



ABSOLUTE MAXIMUM RATINGS

V_{IN1}, V_{IN2} Pin Voltage ($V_{IN1,2}$)	6V
Output Voltage (V_{OUT1}/V_{OUT2})	GND - 0.3 to $V_{IN} + 0.3V$
Enable Voltage (V_{EN1}/V_{EN2})	GND - 0.3 to $V_{IN} + 0.3V$
Power Dissipation (P_D)	Internally Limited
Storage Temperature Range (T_{ST})	-65°C To 150°C
Operating Junction Temperature Range (T_{OPJ})	-40°C To + 125°C
Junction Temperature (T_J)	-40°C To + 150°C
Thermal Resistance from Junction to case (R_{thjc})	15°C/W
Thermal Resistance from Junction to ambient (R_{thja}) ^{Note}	45°C/W

Note: R_{thja} is measured with the PCB copper area of approximately 1 in²(Multi-layer). That need connect to exposed pad.

ELECTRICAL SPECIFICATIONS

($V_{IN1} = V_{IN2} = 5V, T_A = 25^\circ C$ (unless otherwise noted))

Parameter	SYM	TEST CONDITION	MIN	TYP	MAX	UNITS
Input Voltage (Note1)	V_{IN1}	$I_{OUT1}=30mA$	3.4	-	5.5	V
	V_{IN2}	$I_{OUT2}=30mA$	2.8	-	5.5	V
Enable Input Threshold	$V_{EN1/2H}$	Each channel	2.0	-	-	V
	$V_{EN1/2L}$		-	-	0.8	
EN Pull-high Resistance	$R_{EN1/2}$	$V_{IN1} = V_{IN2} = 5V$	1.25	2.6	5	MΩ
Shutdown Current	I_{SD}	$I_{OUT1,2} = 0mA, V_{IN}=5V, V_{EN1,2}=0V$	-	4	8	uA
Temperature Shutdown	$T_{SD1,2}$		-	150	-	°C
Temperature Shutdown Hysteresis	$T_{SDR1,2}$		-	40	-	°C

Regulator1

Output Voltage Accuracy	V_{OUT1}	$I_{OUT1}=30mA$	3.234	3.3	3.366	V
Output Voltage Temperature stability		$I_{OUT1}=10mA$ (Note4)	-	1	-	%
Dropout Voltage	V_{DROP1}	$I_{OUT1}=600mA, V_{OUT1}=V_{OUT1}-2\%$	-	300	500	mV
Quiescent Current	I_{Q1}	$I_{OUT1}=0mA, V_{IN1}=5V$	-	50	80	uA
Line Regulation	V_{Line1}	$V_{IN1} = 4V$ to $5.5V, I_{OUT1} = 30mA$	-	0.1	0.2	%/V
Load Regulation	ΔV_{LOAD}	$I_{OUT1} = 1m\sim 600mA$	-	10	40	mV
Current Limit	I_{LIMIT1}	$V_{IN1} = 5.0V$	700	-	-	mA
Short Circuit Current	I_{Short1}	$V_{OUT1} < 0.25 \times V_{OUT1}$	-	500	-	mA
Ripple Rejection	PSRR1	$I_{OUT1} = 30mA, F=100Hz$	-	-60	-	dB

Regulator2

Output Voltage Accuracy	V_{OUT2}	$I_{OUT2}=30mA$ (APE8839AMP-A)	1.764	1.8	1.836	V	
		$I_{OUT2}=30mA$ (APE8839AMP-B)	1.470	1.5	1.530		
		$I_{OUT2}=30mA$ (APE8839AMP-C)	1.176	1.2	1.224		
Output Voltage Temperature stability		$I_{OUT2}=10mA$	-	1	-	%	
Dropout Voltage	V_{DROP2}	$I_{OUT2}=600mA, V_{OUT2}=V_{OUT2}-2\%$	$V_{OUT}=1.2V$	-	1300	1600	mV
			$V_{OUT}=1.5V$	-	1000	1300	
			$V_{OUT}=1.8V$	-	700	1000	
Quiescent Current	I_{Q2}	$I_{OUT2} = 0mA, V_{IN2} = 5V$	-	50	80	uA	
Line Regulation	V_{Line2}	$V_{IN2} = 2.8V$ to $5.5V, I_{OUT2} = 30mA$	-	0.1	0.2	%/V	
Load Regulation (Note3)	ΔV_{LOAD}	$I_{OUT2} = 1m\sim 600mA$	-	10	30	mV	
Current Limit (Note2)	I_{LIMIT2}	$V_{IN2} = 5.0V$	700	-	-	mA	
Short Circuit Current	I_{Short2}	$V_{OUT2} < 0.25 \times V_{OUT2}$	-	500	-	mA	
Ripple Rejection	PSRR2	$I_{OUT2} = 30mA, F=100Hz$	-	-60	-	dB	

Note1: The device is not guaranteed to function outside its operating conditions.

Note2: Current limit is measured at constant junction temperature by using pulsed testing with a low ON time.

Note3: Regulation is measured at constant junction temperature by using pulsed testing with a low ON time.

Note4: Guaranteed by design.



PIN DESCRIPTIONS

PIN SYMBOL	PIN DESCRIPTION
GND	Common Ground
EN1	Channel 1 Shutdown Control Pin, the pin is internal pull high.
EN2	Channel 2 Shutdown Control Pin, the pin is internal pull high.
VOUT1	Channel1 Output Voltage
VOUT2	Channel2 Output Voltage
VIN1	Channel1 input Voltage
VIN2	Channel2 input Voltage

BLOCK DIAGRAM

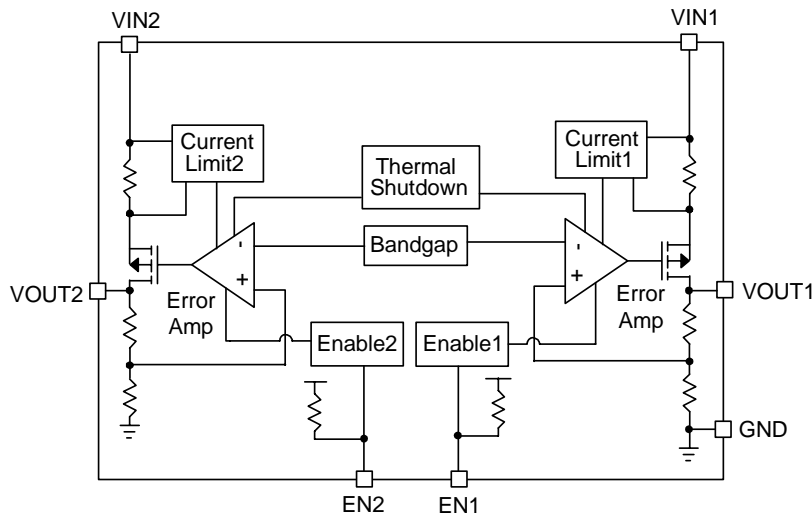

FUNCTION DESCRIPTIONS

The APE8839A is a highly accurate, dual, low noise, CMOS LDO voltage regulators with enable function. The output voltage for each regulator is set independently by fuse trimming. As illustrated in function block diagram, it consists of a reference, error amplifier, a P-channel pass transistor, an ON/OFF control logic and an internal feedback voltage divider. The band gap reference is connected to the error amplifier, which compares the reference with the feedback voltage and amplifies the voltage difference. If the feedback voltage is lower than the reference voltage, the pass- transistor gate is pulled lower, which allows more current to pass to the VOUT pin and increases the output voltage. If the feedback voltage is too high, the pass transistor gate is pulled up to decrease the output voltage. The output voltage is feed back through an internal resistive divider connected to VOUT pin. Additional blocks include an output current limiter, thermal sensor, and shutdown logic.

Enable Function

EN1 and EN2 pin start and stop the corresponding outputs independently. Those pins are internal pull high. When the EN pin is switched to the power off level, the operation of all internal circuit stops, the build-in P-channel MOSFET output transistor between pins VIN and VOUT is switched off, allowing current consumption to be drastically reduced.

For sensitive applications, due to the high internal pull-high resistance value, we recommend add the external pull-high resistor to reduce any external influence, such as the side effect brought by high humidity environment.



Dropout Voltage

A regulator's minimum input-output voltage differential, or dropout voltage, determines the lowest usable supply voltage. The APE8839A use a P- channel MOSFET pass transistor, its dropout voltage is function of drain-to-source on-resistance R_{DS(ON)} multiplied by the load current.

$$V_{\text{DROPOUT}} = V_{\text{IN}} - V_{\text{OUT}} = R_{\text{DS(ON)}} \times I_{\text{OUT}}$$

Current Limit

Each channel of APE8839A includes a fold back current limiter. It monitors and controls the pass transistor's gate voltage, estimates the output current, and limits the output current minimum 700mA.

Thermal Shutdown Protection

Thermal Shutdown protection limits total power dissipation of APE8839A. When the junction temperature exceeds $T_J = +150^\circ\text{C}$, a thermal sensor turns off the pass transistor, allowing the IC to cool down. The thermal sensor turns the pass transistor on again after the junction temperature cools down by 25°C , resulting in a pulsed output during continuous thermal shutdown conditions.

Thermal shutdown protection is designed to protect the APE8839A in the event of fault conditions. For continuous operation, the absolute maximum operating junction temperature rating of $T_J = +125^\circ\text{C}$ should not be exceeded.

Application Information

Like any low-dropout regulator, the APE8839A requires input and output decoupling capacitors. The device is specifically designed for portable applications requiring minimum board space and smallest components. These capacitors must be correctly selected for good performance (see Capacitor Characteristics Section). Please note that linear regulators with a low dropout voltage have high internal loop gains which require care in guarding against oscillation caused by insufficient decoupling capacitance.

Input Capacitor

An input capacitance of $1 \mu\text{F}$ is required between input pin and ground directly (the amount of the capacitance may be increased without limit). The input capacitor must be located less than 1cm from the device to assure input stability. A lower ESR capacitor allows the use of less capacitance, while higher ESR type (like aluminum electrolytic) requires more capacitance. Capacitor types (aluminum, ceramic and tantalum) can be mixed in parallel, but the total equivalent input capacitance/ ESR must be defined as above to stable operation. There are no requirements for the ESR on the input capacitor, but tolerance and temperature coefficient must be considered when selecting the capacitor to ensure the capacitance will be $1 \mu\text{F}$ over the entire operating temperature range.



Output Capacitor

The APE8839A is designed specifically to work with very small ceramic output capacitors. A ceramic capacitor (temperature characteristics X7R, X5R) in 1 μ F is suitable for the APE8839A application. The recommended minimum capacitance for the device is 1 μ F, X5R or X7R dielectric ceramic, between VOUT and GND for stability, but it may be increased without limit. Higher capacitance values help to improve transient. The output capacitor's ESR is critical because it forms a zero to provide phase lead which is required for loop stability.

Thermal Considerations

The APE8839A series can deliver a current of up to 600mA/channel over the full operating junction temperature range. However, the maximum output current must be debated at higher ambient temperature to ensure the junction temperature does not exceed 125°C. With all possible conditions, the junction temperature must be within the range specified under operating conditions. Power dissipation can be calculated based on the output current and the voltage drop across regulator.

$$P_D = (V_{IN} - V_{OUT}) I_{OUT} + V_{IN} \times I_Q$$

The final operating junction temperature for any set of conditions can be estimated by the following thermal equation:

$$P_{D(MAX)} = (T_{J(MAX)} - T_A) / R_{thJA}$$

Where $T_{J(MAX)}$ is the maximum junction temperature of the die (125° C) and T_A is the maximum ambient temperature. The junction to ambient thermal resistance (R_{thJA}) ESOP-8 package at recommended minimum footprint is 45°C/W that is connect 1 in² PCB copper area to exposed pad.



TYPICAL PERFORMANCE CHARACTERISTICS

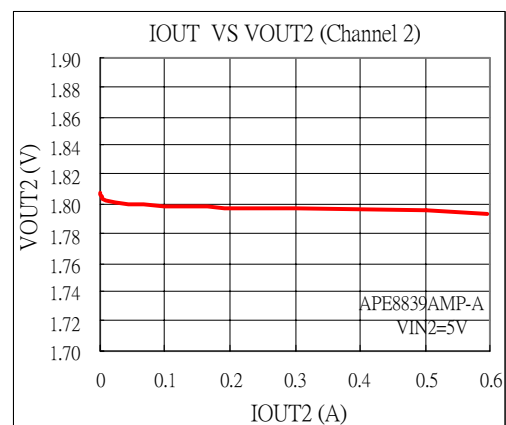
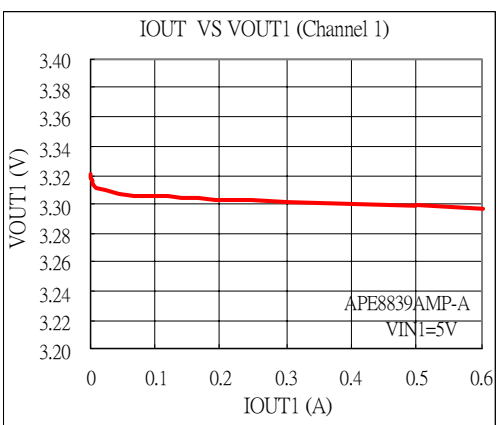
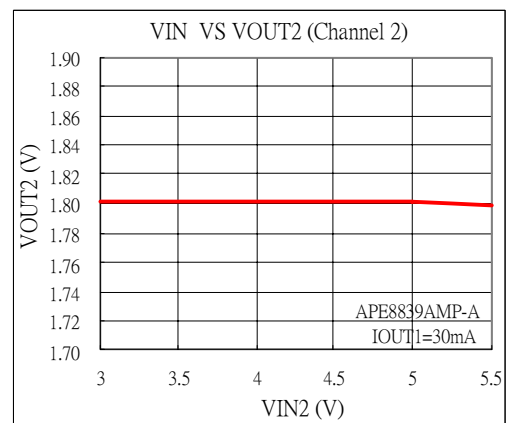
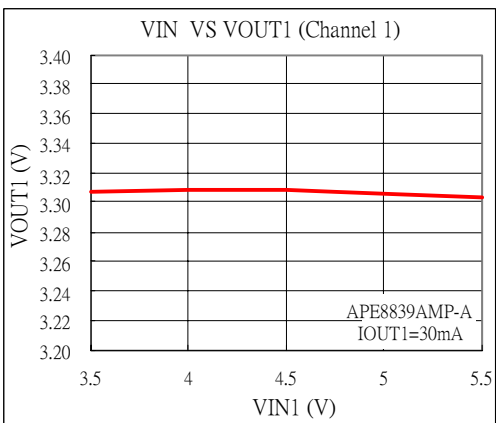
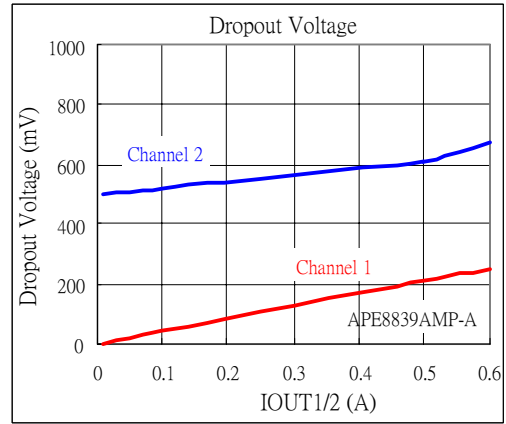
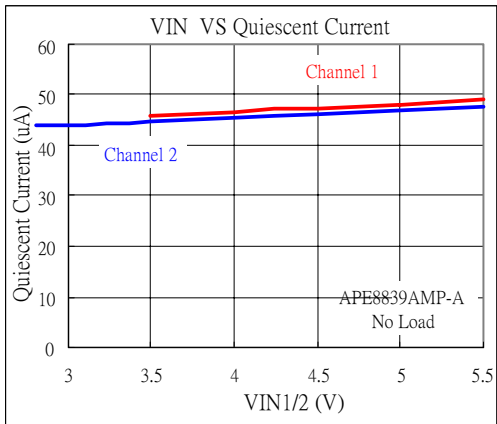



TYPICAL PERFORMANCE CHARACTERISTICS

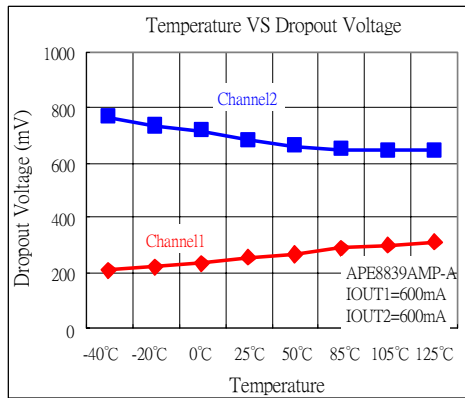
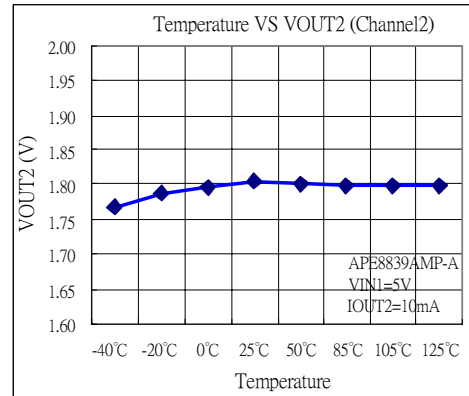
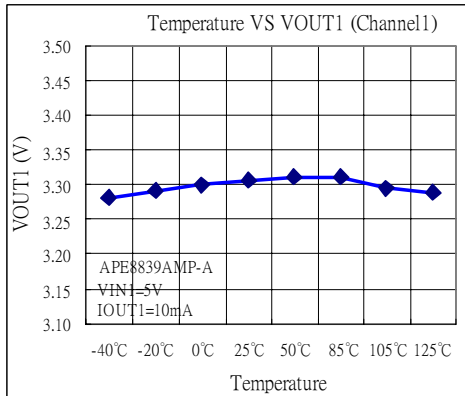



TYPICAL PERFORMANCE CHARACTERISTICS

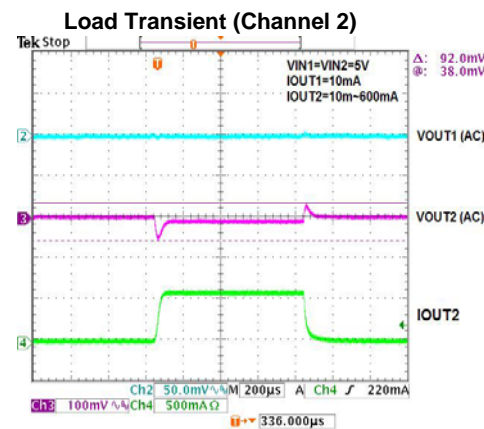
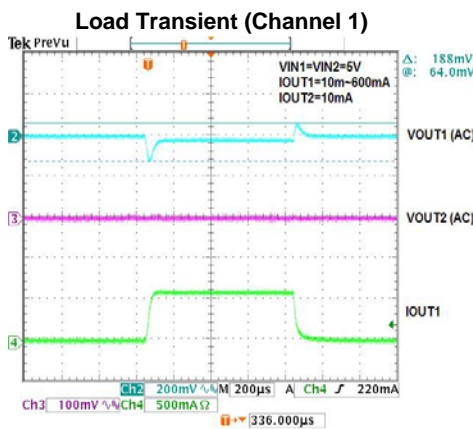
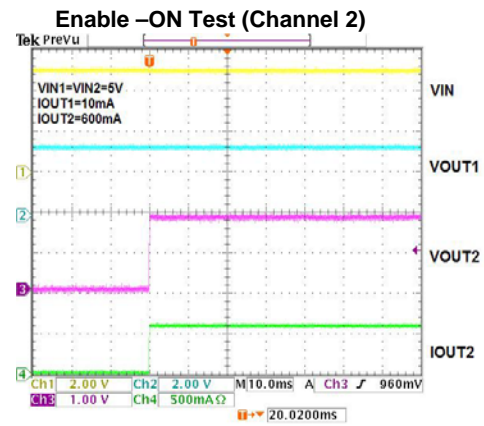
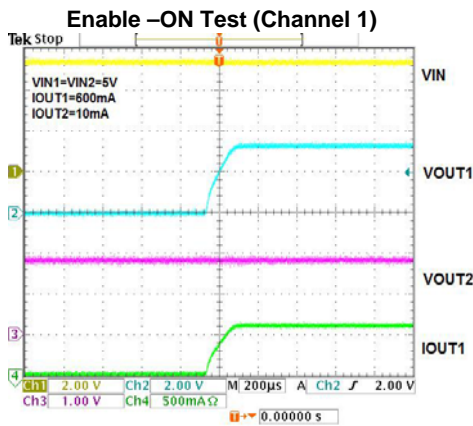
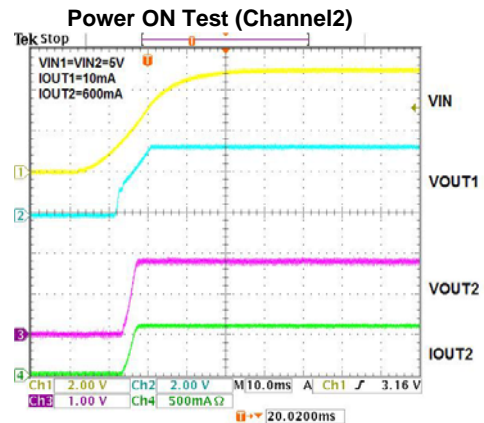
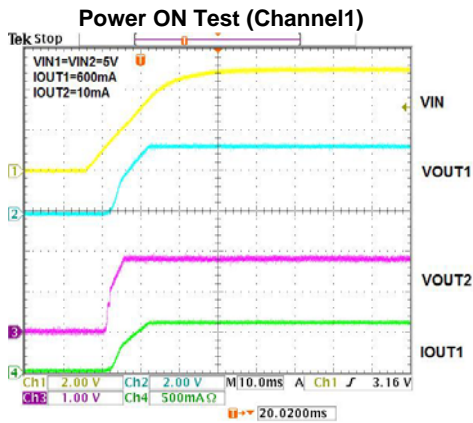



MARKING INFORMATION

ESOP-8

