

**Pb-free
HEAT**



JRGB1316LS

PLCC-6 Type Tri-color

Features

Package	PLCC-6 Type, Milky White resin
Product features	<ul style="list-style-type: none"> • Outer Dimension 6.0 x 6.0 x 1.6mm (L x W x H) • Temperature range Storage Temperature : -40°C~100°C Operating Temperature: -40°C~85°C • Lead-free soldering compatible • RoHS compliant
Dominant wavelength	Blue : 470nm Green : 525nm Red : 625nm
Half Intensity Angle	120 deg.
Die materials	Blue, Green : InGaN Red : AlGaInP
Rank grouping parameter	Sorted by chromaticity per rank taping
Assembly method	Auto pick & place machine (Auto Mounter)
Soldering methods	Reflow soldering and manual soldering
Taping and reel	1,000pcs per reel in a 12mm width tape. (Standard) Reel diameter: ϕ 180mm

Recommended Applications

Cellular Phone, Electric Household Appliances, Amusement Equipment, Other General Applications

Color and Luminous Intensity

(Ta=25°C)

<One LED Die lighted>

Part No.	Material	Emitted Color	Lens Color	Dominant Wavelength		Luminous Intensity		
				λd (nm)		Iv (mcd)		
				TYP.	I _F	MIN.	TYP.	I _F
JRGB1316LS	InGaN	Blue	Milky White	470	10	-	220	10
	InGaN	Green		525	20	-	1,100	20
	AlGaInP	Red		625	30	-	480	30

<White Sorting of Simultaneous RGB Lighting>

Part No.	Emitted Color	Total Luminous Intensity			Chromaticity Coordinates	
		Iv (mcd)			x	y
		MIN.	TYP.	I _F	TYP.	TYP.
JRGB1316LS	Blue	-	1,800	10	0.29	0.29
	Green			20		
	Red			30		

Absolute Maximum Ratings

(Ta=25°C)

Item		Symbol	Absolute Maximum Ratings			Unit
			Blue	Green	Red	
Power Dissipation		P_d	120	168	140	mW
Total Value of Power Dissipation		P_d	360 ^{※1}			mW
Forward Current	One Diode Lighted	I_F	30	40	45	mA
	All Diodes Lighted	I_F	20	35	45	mA
Pulse Forward Current ^{※2}	One Diode Lighted	I_{FRM}	150	150	150	mA
	All Diodes Lighted	I_{FRM}	120	120	120	mA
Derating (Ta=60°C or higher)	One Diode Lighted	ΔI_F	0.8	1.0	1.0	mA/°C
		ΔI_{FRM}	3.6	3.6	3.6	mA/°C
	All Diodes Lighted	ΔI_F	0.6	1.0	1.0	mA/°C
		ΔI_{FRM}	3.6	3.6	3.6	mA/°C
Reverse Voltage		V_R	5	5	5	V
Operating Temperature		T_{opr}	-40~+85			°C
Storage Temperature		T_{stg}	-40~+100			°C

※1 The maximum Power Dissipation at the time of Simultaneous RGB Lighting (White lighting)

 ※2 I_{FRM} Measurement condition : Pulse Width ≤ 1 ms., Duty $\leq 1/20$.

Electro-Optical Characteristics

(Ta=25°C)

Item	Conditions	Symbol	Characteristics			Unit	
			Blue	Green	Red		
Forward Voltage	Blue: I _F =10mA Green: I _F =20mA Red: I _F =30mA	V _F	TYP.	3.07	3.2	2.35	V
			MAX.	3.8	4.0	3.0	
Reverse Current	V _R =5V	I _R	MAX.	100	100	100	μ A
Dominant Wavelength	Blue: I _F =10mA Green: I _F =20mA Red: I _F =30mA	λ _d	TYP.	470	525	625	nm
Spectral Line Half Width	Blue: I _F =10mA Green: I _F =20mA Red: I _F =30mA	Δλ	TYP.	19	32	18	nm
Half Intensity Angle	Blue: I _F =10mA Green: I _F =20mA Red: I _F =30mA	2 θ 1/2	TYP.	120	120	120	deg.

Sorting Chart for Chromaticity Coordinates

(Ta=25°C)

<White Sorting of Simultaneous RGB Lighting>

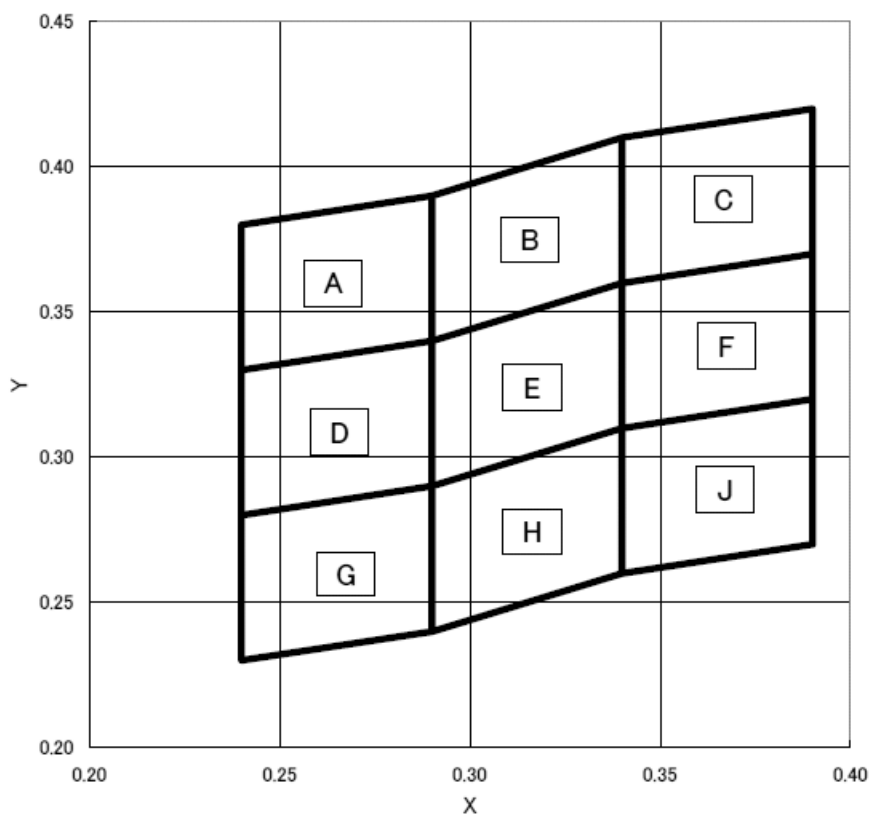

Rank	LEFT DOWN point		LEFT UP point		RIGHT UP point		RIGHT UP point		Conditions
	x	y	x	y	x	y	x	y	
A	0.240	0.330	0.240	0.380	0.290	0.390	0.290	0.340	Blue I _F =10mA
B	0.290	0.340	0.290	0.390	0.340	0.410	0.340	0.360	
C	0.340	0.360	0.340	0.410	0.390	0.420	0.390	0.370	
D	0.240	0.280	0.240	0.330	0.290	0.340	0.290	0.290	Green I _F =20mA
E	0.290	0.290	0.290	0.340	0.340	0.360	0.340	0.310	
F	0.340	0.310	0.340	0.360	0.390	0.370	0.390	0.320	
G	0.240	0.230	0.240	0.280	0.290	0.290	0.290	0.240	Red I _F =30mA
H	0.290	0.240	0.290	0.290	0.340	0.310	0.340	0.260	
J	0.340	0.260	0.340	0.310	0.390	0.320	0.390	0.270	

Chromaticity Coordinates Tolerance Each Rank : +/-0.02

Please contact our sales staff concerning rank designation.

Technical Data(Blue)

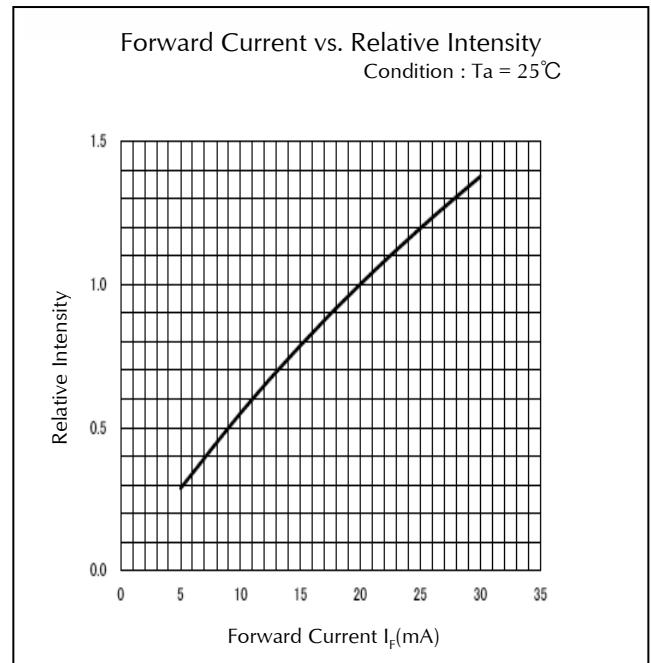
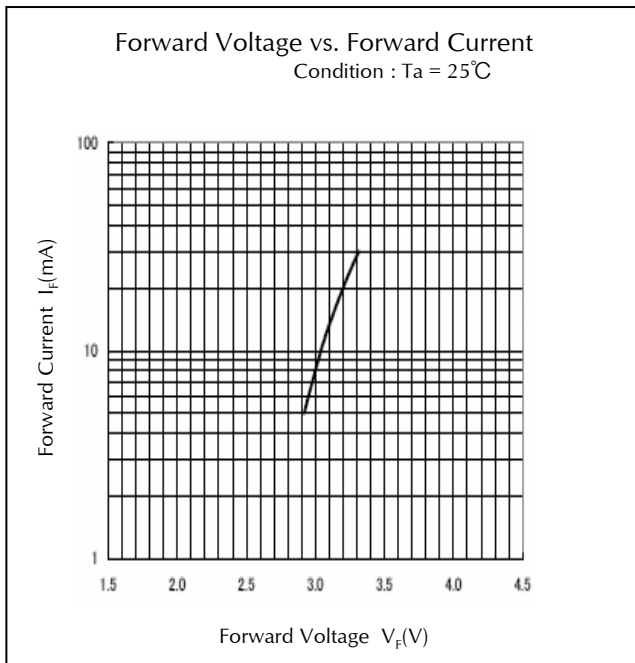
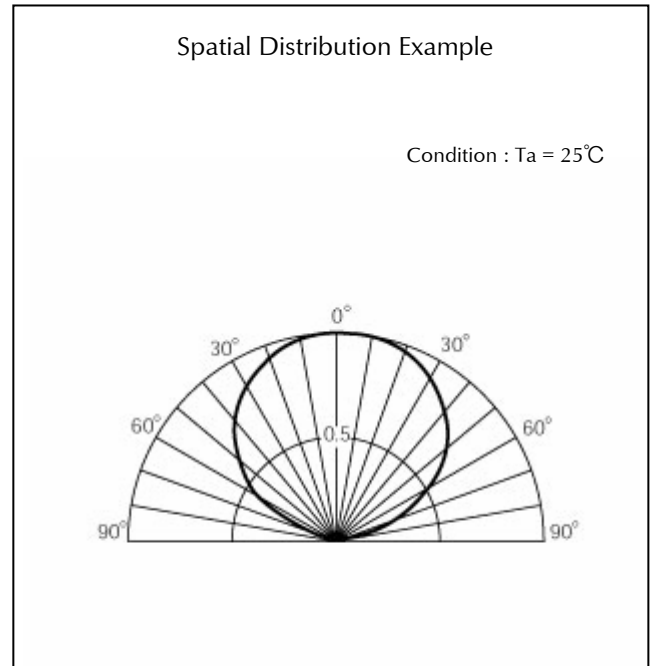
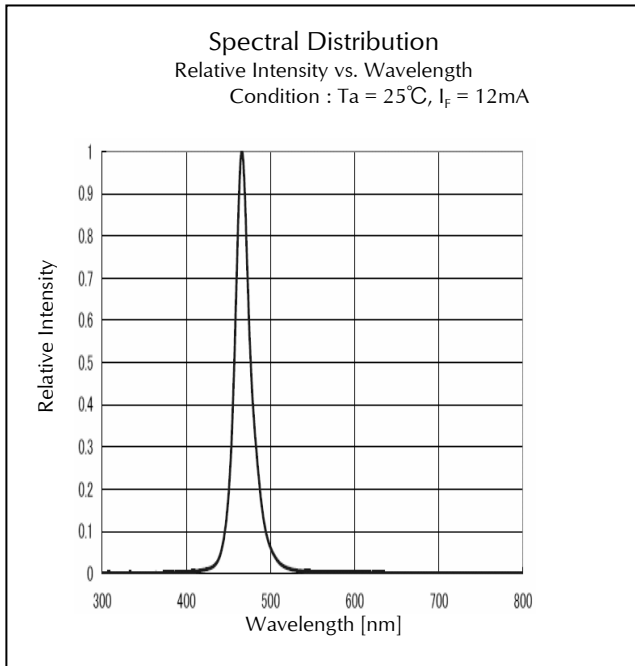

Technical Data(Blue)

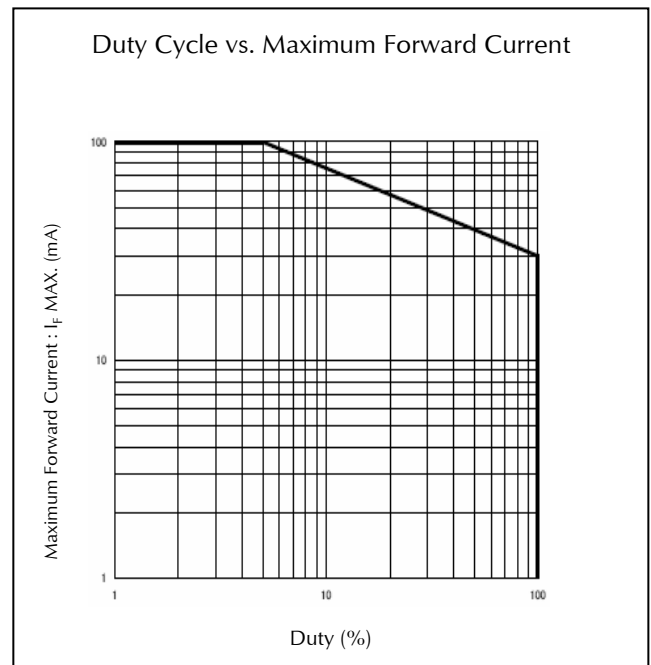
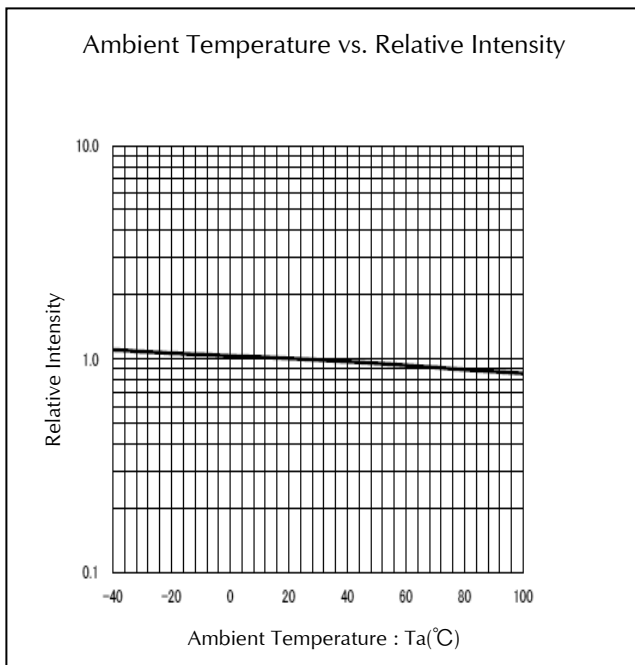
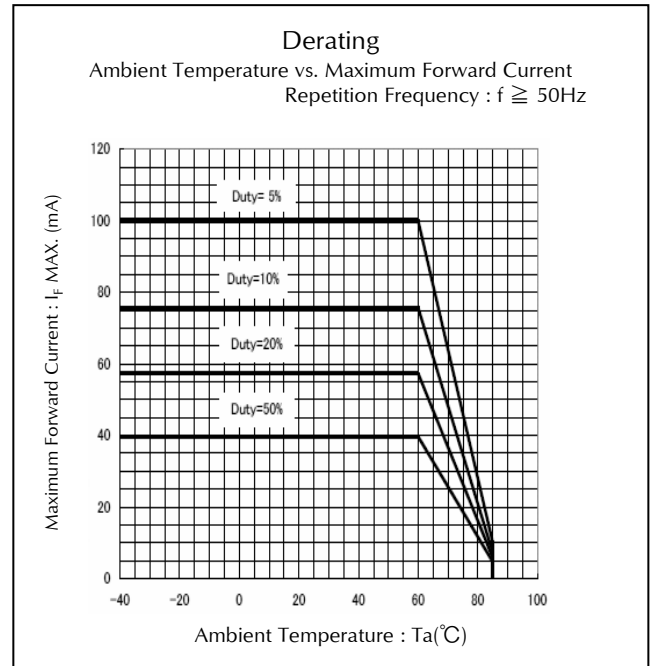
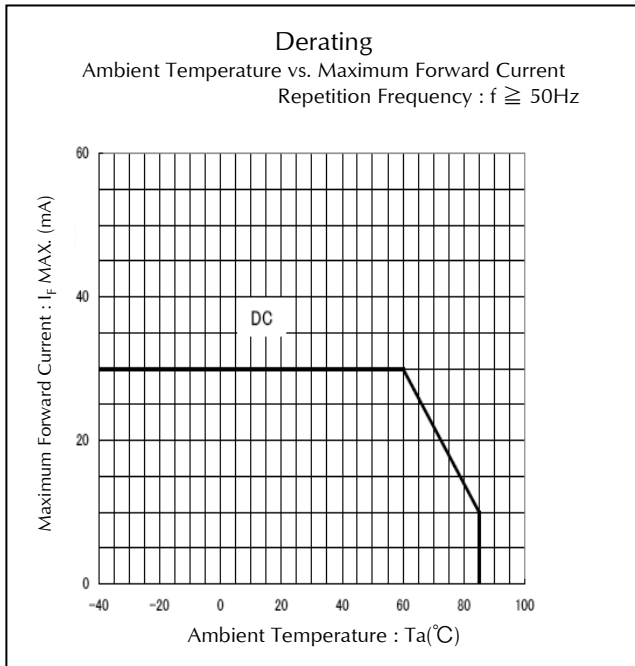

Technical Data(Green)

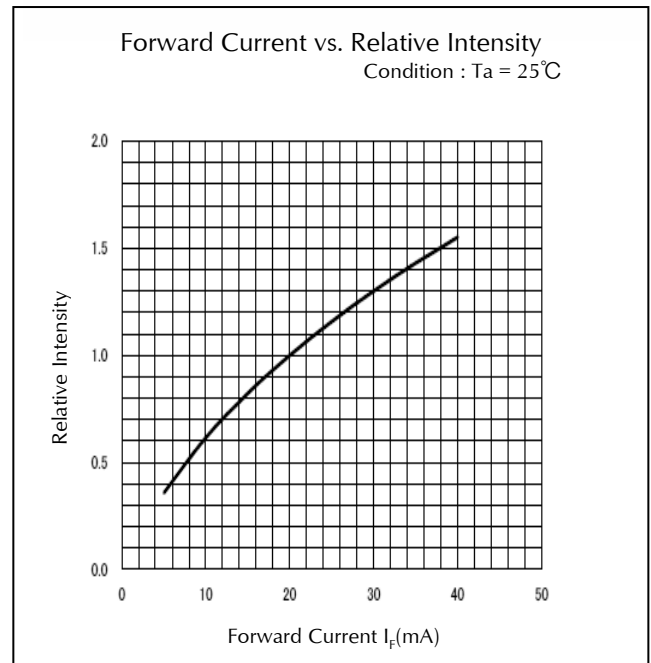
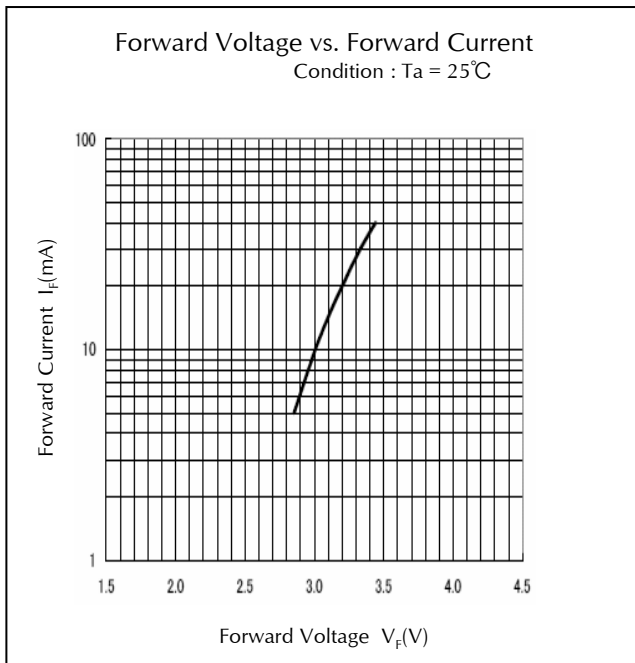
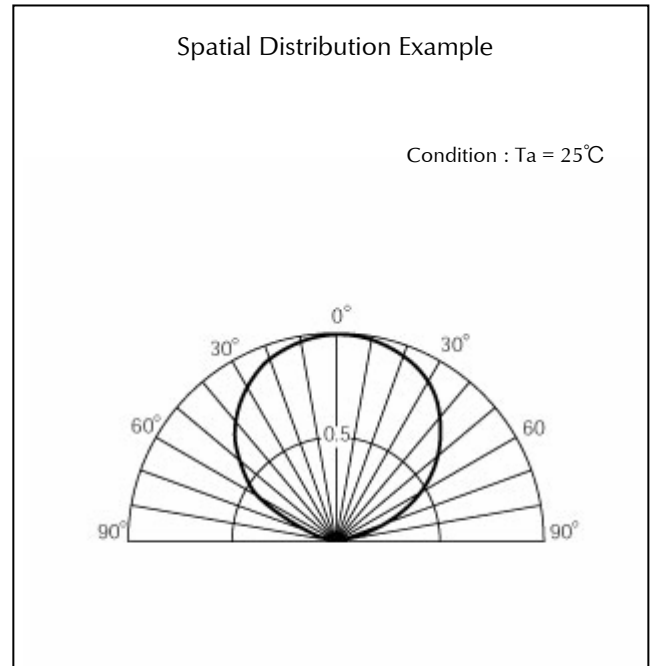
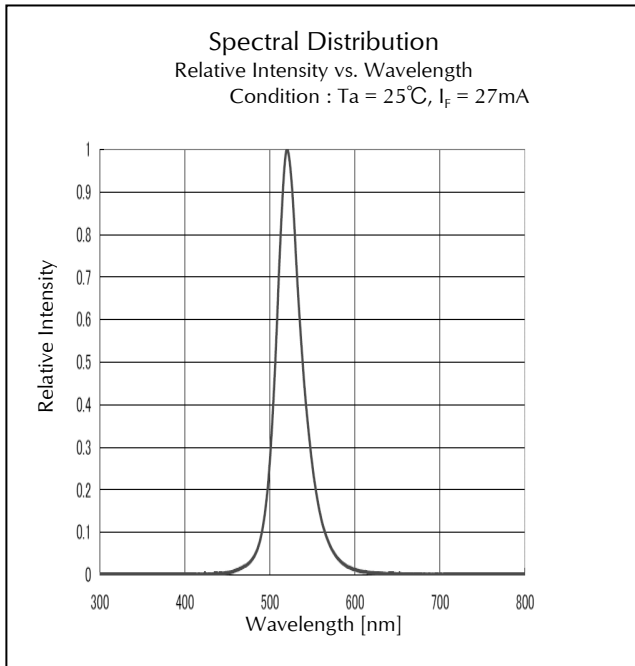

Technical Data(Green)

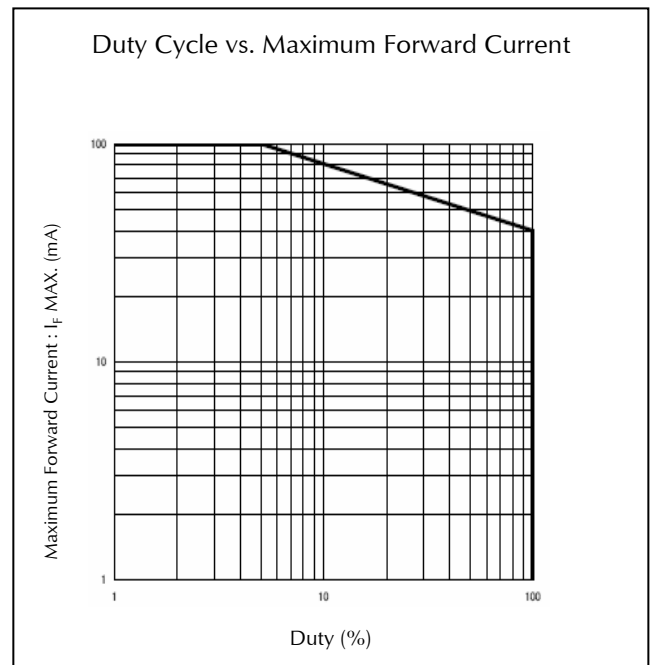
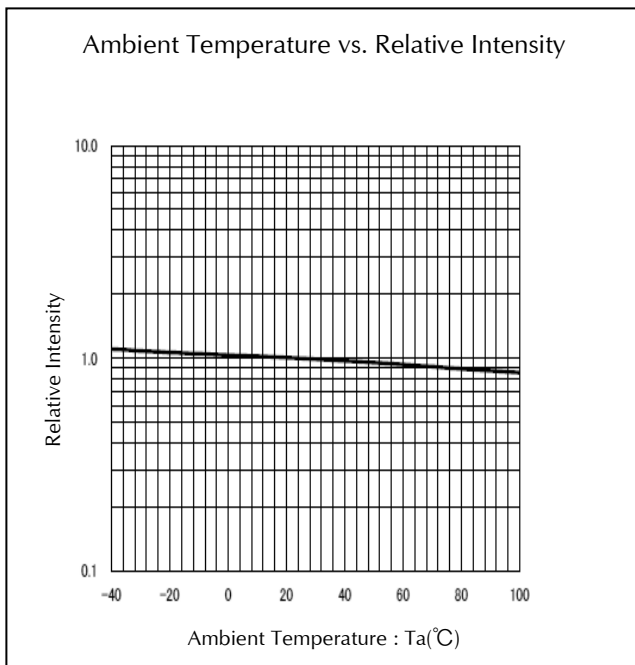
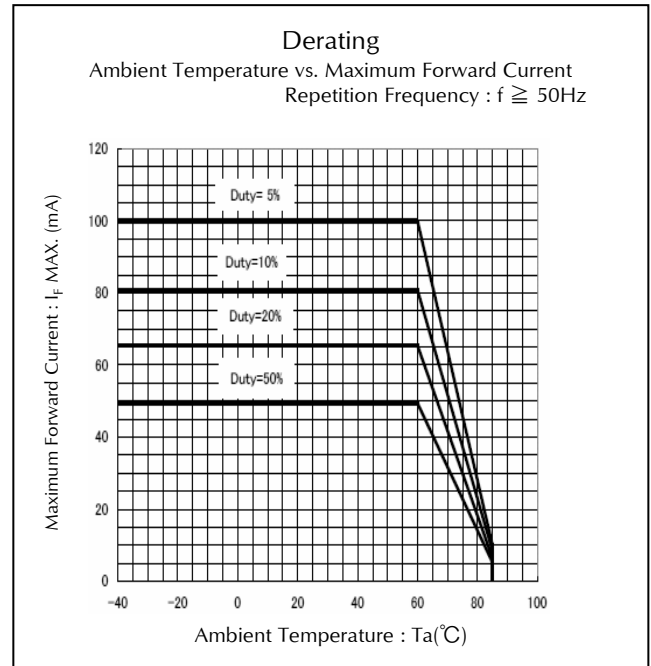
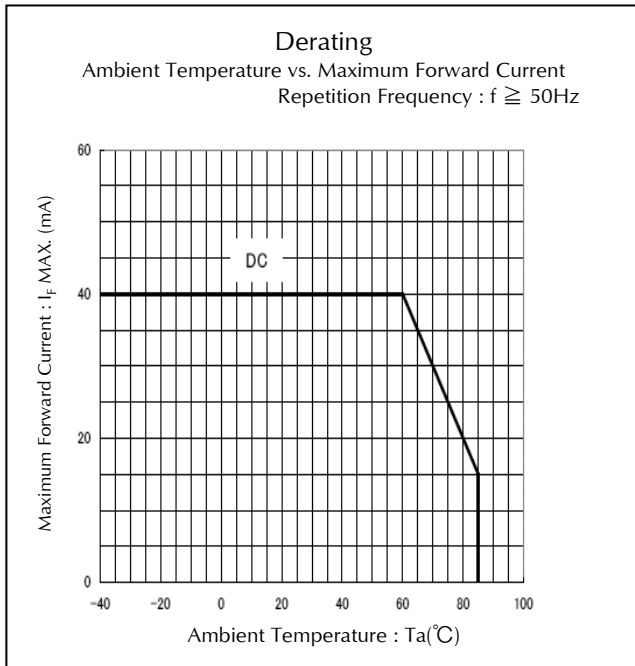

Technical Data(Red)

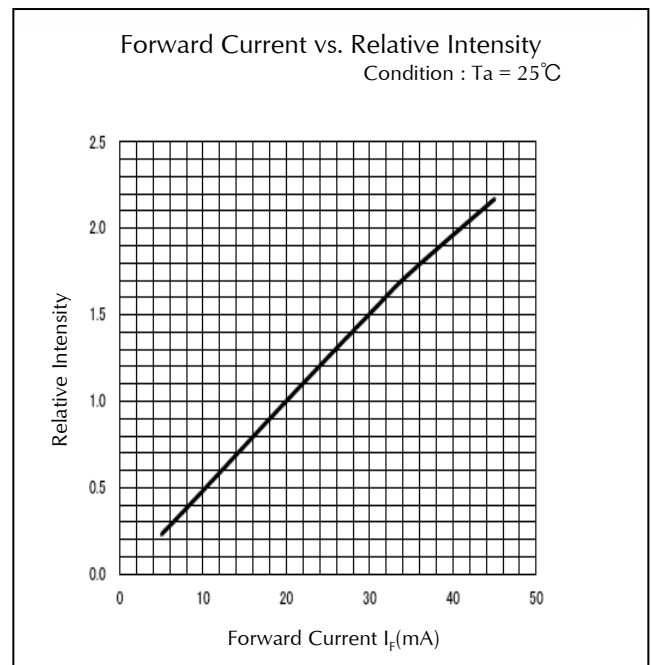
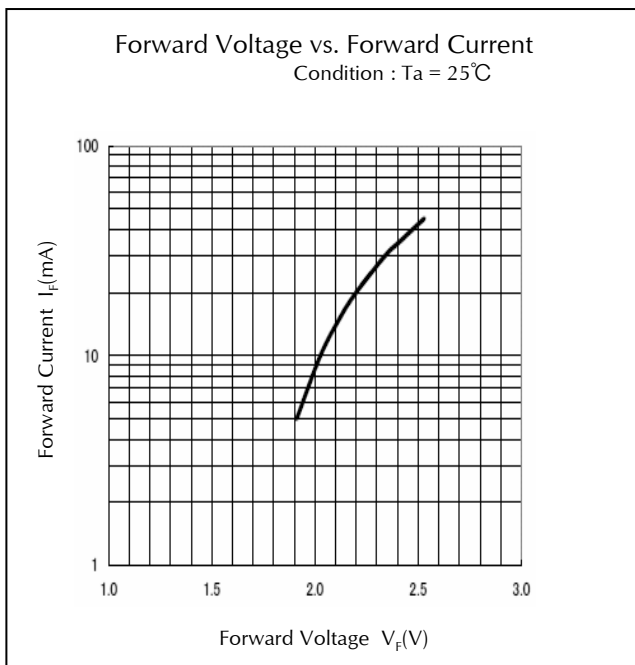
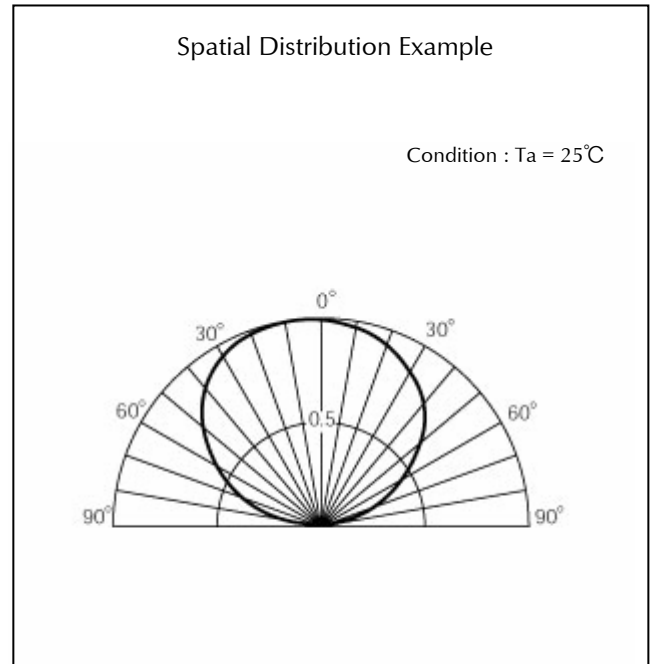
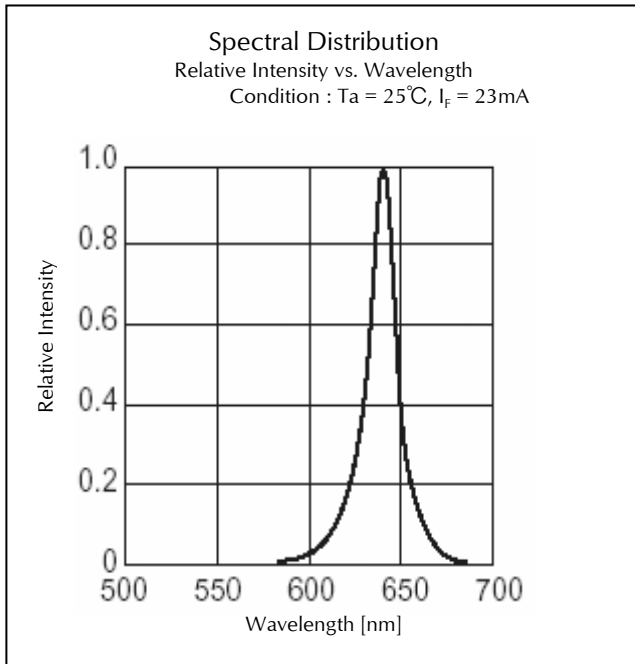

Technical Data(Red)

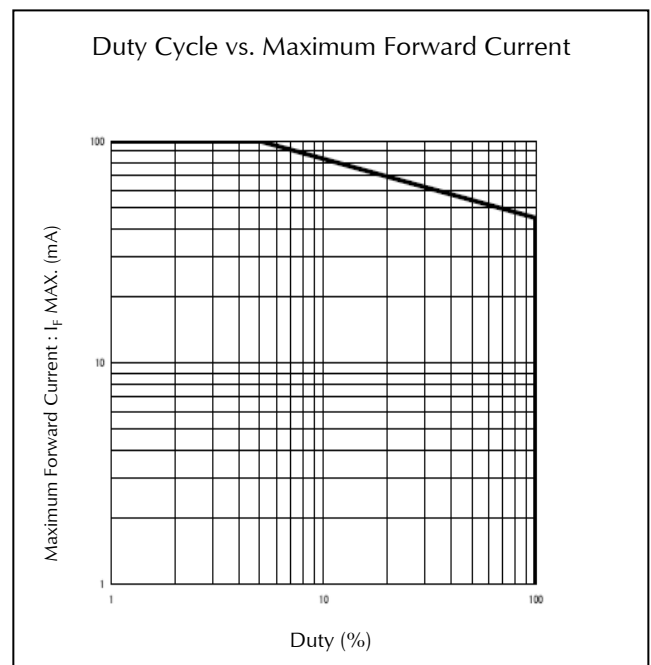
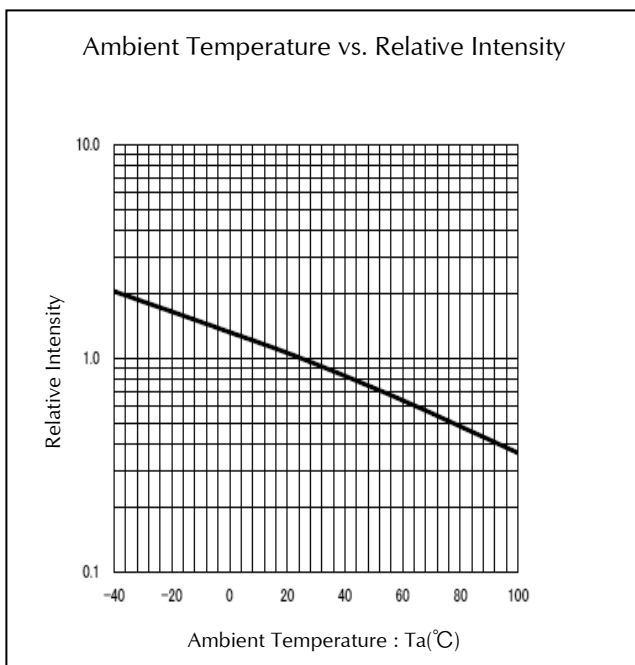
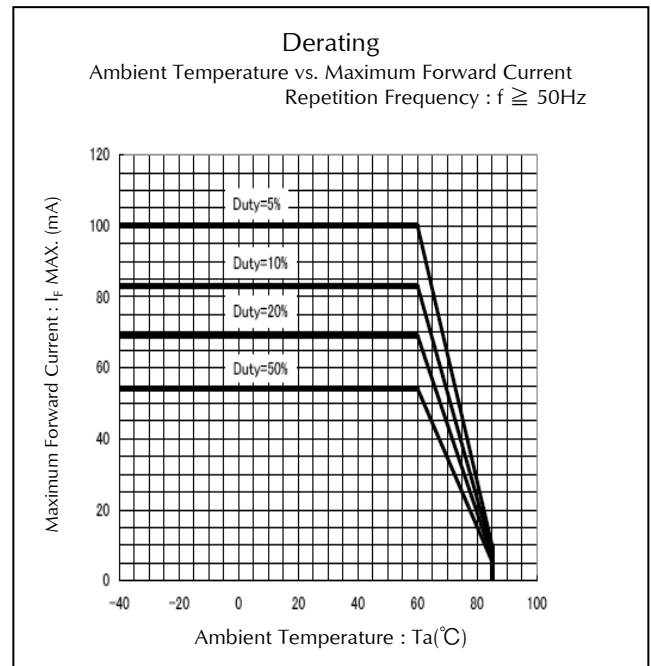
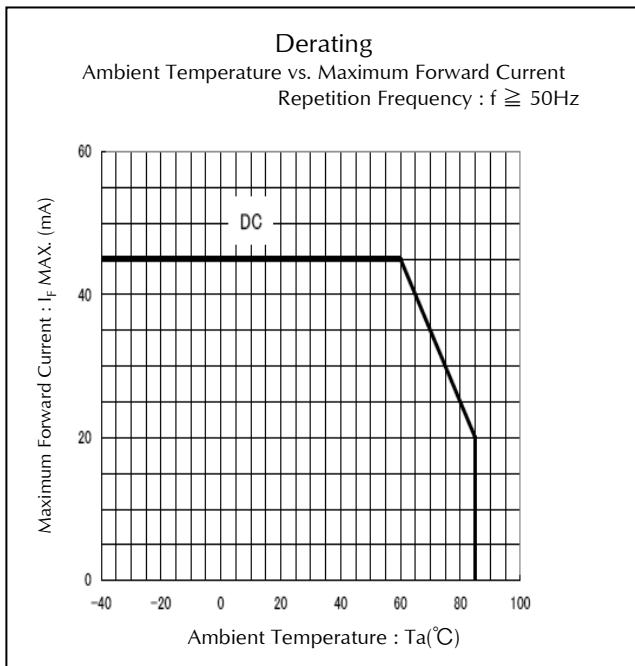

Package Dimensions

(Unit: mm)

Weight: (113.1)mg

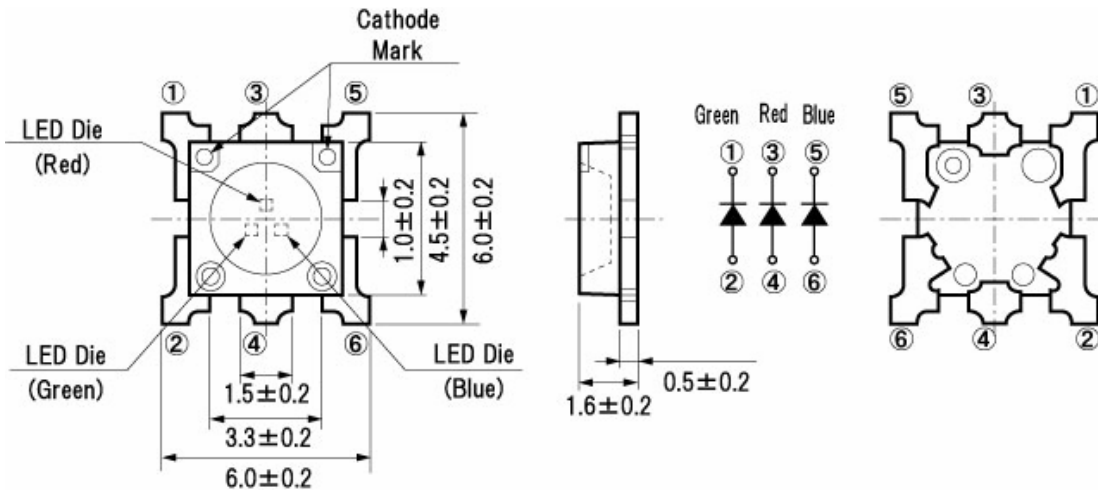

Recommended Soldering Pattern

(Unit: mm)

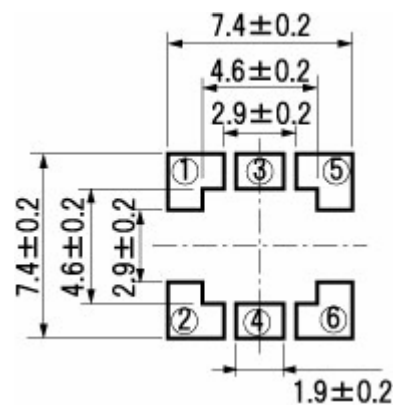

Taping Specification

(Unit: mm)

Quantity: 1,000pcs/ reel (standard)

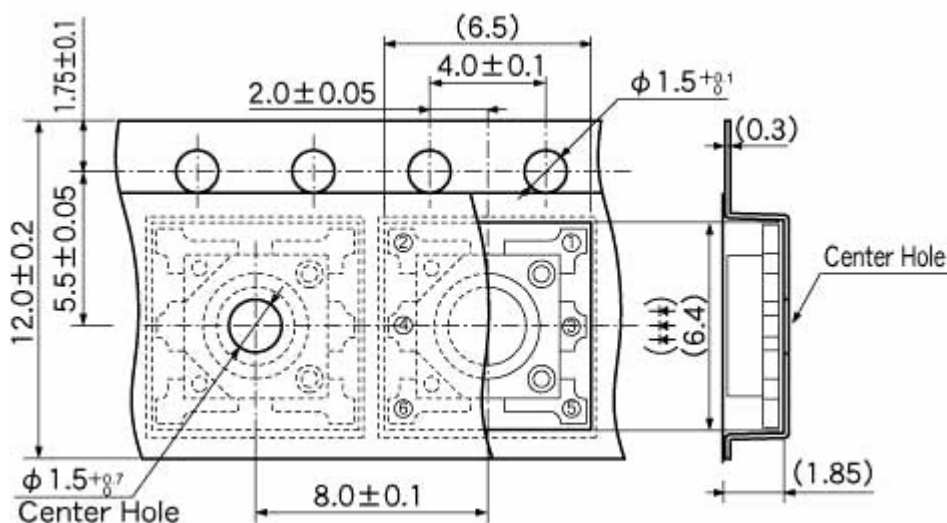

Reflow Soldering Conditions

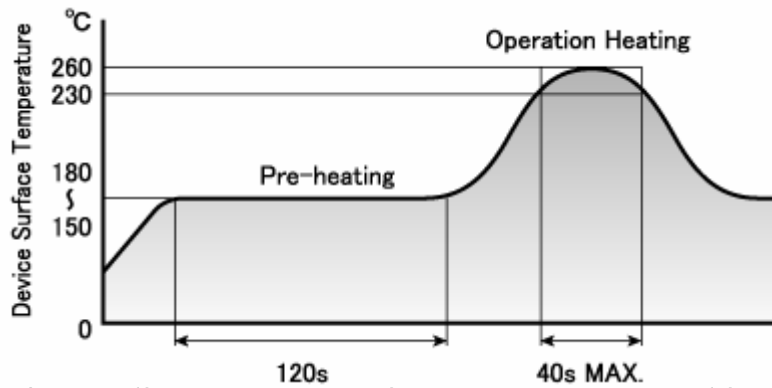

- 1) The above profile temperature gives the maximum temperature of the LED resin surface. Please set the temperature so as to avoid exceeding this range.
- 2) Total times of reflow soldering process shall be no more than 2 times. When the second reflow soldering process is performed, intervals between the first and second reflow should be short as possible (while allowing some time for the component to return to normal temperature after the first reflow) in order to prevent the LED from absorbing moisture.
- 3) Temperature fluctuation to the LED during the pre-heating process shall be minimized. (6°C maximum)

Manual Soldering Conditions

Iron tip temp.	350 °C	(MAX.)
Soldering time and frequency	3 s	(MAX.)
	1 time	(MAX.)

Reliability Testing Result

Reliability Testing Result	Applicable Standard	Testing Conditions	Duration	Failure
Room Temp. Operating Life	EIAJ ED-4701/100(101)	Ta = 25°C, If = 20mA(Blue), If = 35mA(Green), If = 45mA(Red), All Diodes Lighted.	1,000 h	0/25
Resistance to Soldering Heat	EIAJ ED-4701/300(301)	Pre-heating : 150~180°C 120s Max. Operation Heating : 230°C 40s Max. Peak Temperature : 260°C	Twice	0/25
Temperature Cycling	EIAJ ED-4701/100(105)	Minimum Rated Storage Temperature(30min) ~Normal Temperature(15min) ~Maximum Rated Storage Temperature(30min) ~Normal Temperature(15min)	5 cycles	0/25
Wet High Temp. Storage Life	EIAJ ED-4701/100(103)	Ta = 60±2°C, RH = 90±5%	1,000 h	0/25
High Temp. Storage Life	EIAJ ED-4701/200(201)	Ta = Maximum Rated Storage Temperature	1,000 h	0/25
Low Temp. Storage Life	EIAJ ED-4701/200(202)	Ta = Minimum Rated Storage Temperature	1,000 h	0/25
Vibration, Variable Frequency	EIAJ ED-4701/400(403)	98.1m/s ² (10G), 100 ~ 2KHz sweep for 20min., XYZ each direction	2 h	0/10

Failure Criteria

Items	Symbols	Conditions	Failure criteria
Luminous Intensity	Iv	If Value of each product Luminous Intensity	Testing Min. Value < Spec. Min. Value x 0.5
Forward Voltage	V _F	If Value of each product Forward Voltage	Testing Max. Value ≥ Spec. Max. Value x 1.2
Reverse Current	I _R	V _R = Maximum Rated Reverse Voltage V	Testing Max. Value ≥ Spec. Max. Value x 2.5
Cosmetic Appearance	-	-	Occurrence of notable decoloration, deformation and cracking

Special Notice to Customers Using the Products and Technical Information Shown in This Data Sheet

- 1) The technical information shown in the data sheets are limited to the typical characteristics and circuit examples of the referenced products. It does not constitute the warranting of industrial property nor the granting of any license.
- 2) For the purpose of product improvement, the specifications, characteristics and technical data described in the data sheets are subject to change without prior notice. Therefore it is recommended that the most updated specifications be used in your design.
- 3) When using the products described in the data sheets, please adhere to the maximum ratings for operating voltage, heat dissipation characteristics, and other precautions for use. We are not responsible for any damage which may occur if these specifications are exceeded.
- 4) The products that have been described to this catalog are manufactured so that they will be used for the electrical instrument of the benchmark (OA equipment, telecommunications equipment, AV machine, home appliance and measuring instrument).
The application of aircrafts, space borne application, transportation equipment, medical equipment and nuclear power control equipment, etc. needs a high reliability and safety, and the breakdown and the wrong operation might influence the life or the human body. Please consult us beforehand if you plan to use our product for the usages of aircrafts, space borne application, transportation equipment, medical equipment and nuclear power control equipment, etc. except OA equipment, telecommunications equipment, AV machine, home appliance and measuring instrument.
- 5) In order to export the products or technologies described in this data sheet which are under the "Foreign Exchange and Foreign Trade Control Law," it is necessary to first obtain an export permit from the Japanese government.
- 6) No part of this data sheet may be reprinted or reproduced without prior written permission from Stanley Electric Co., Ltd.
- 7) The most updated edition of this data sheet can be obtained from the address below:
<http://www.stanley-components.com>