

# Small Signal MOSFET

## 115 mAmps, 60 Volts

### N-Channel SOT-723

- Pb-Free Package is Available.
- S- Prefix for Automotive and Other Applications Requiring Unique Site and Control Change Requirements; AEC-Q101 Qualified and PPAP Capable.

#### ORDERING INFORMATION

Device	Marking	Shipping
L2N7002M3T5G S-L2N7002M3T5G	72	8000 Tape & Reel

#### MAXIMUM RATINGS

Rating	Symbol	Value	Unit
Drain-Source Voltage	$V_{DSS}$	60	V <sub>dc</sub>
Drain-Gate Voltage ( $R_{GS} = 1.0 \text{ M}\Omega$ )	$V_{DGR}$	60	V <sub>dc</sub>
Drain Current			
– Continuous $T_C = 25^\circ\text{C}$ (Note 1.)	$I_D$	$\pm 115$	mA <sub>dc</sub>
– Pulse $t < 10\mu\text{s}$	$I_{DM}$	$\pm 800$	
Gate-Source Voltage			
– Continuous	$V_{GS}$	$\pm 20$	V <sub>dc</sub>

#### THERMAL CHARACTERISTICS

Characteristic	Symbol	Max	Unit
Total Device Dissipation FR-5 Board (Note 2.) $T_A = 25^\circ\text{C}$ Derate above $25^\circ\text{C}$	$P_D$	150 1.2	mW mW/ $^\circ\text{C}$
Thermal Resistance, Junction to Ambient	$R_{\theta JA}$	833	$^\circ\text{C}/\text{W}$
Junction and Storage Temperature	$T_J, T_{stg}$	-55 to +150	$^\circ\text{C}$

1. The Power Dissipation of the package may result in a lower continuous drain current.
2. FR-5 = 1.0 x 0.75 x 0.062 in.
3. Alumina = 0.4 x 0.3 x 0.025 in 99.5% alumina.

L2N7002M3T5G  
S-L2N7002M3T5G

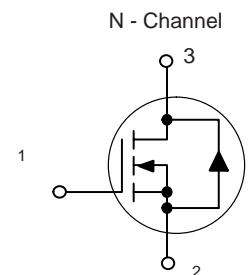
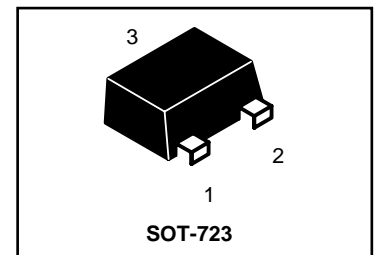

#### MARKING DIAGRAM & PIN ASSIGNMENT

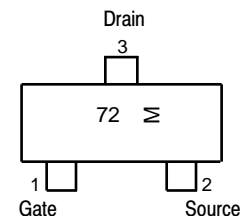

72 = Device Code  
M = Month Code

**L2N7002M3T5G , S-L2N7002M3T5G**

**ELECTRICAL CHARACTERISTICS** ( $T_A = 25^\circ\text{C}$  unless otherwise noted)

Characteristic	Symbol	Min	Typ	Max	Unit
<b>OFF CHARACTERISTICS</b>					
Drain–Source Breakdown Voltage ( $V_{GS} = 0, I_D = 10 \mu\text{A}$ )	$V_{(BR)DSS}$	60	–	–	Vdc
Zero Gate Voltage Drain Current ( $V_{GS} = 0, V_{DS} = 60 \text{ Vdc}$ )	$I_{DSS}$	–	–	1.0 500	$\mu\text{A}$
Gate–Body Leakage Current, Forward ( $V_{GS} = 20 \text{ Vdc}$ )	$I_{GSSF}$	–	–	100	nA
Gate–Body Leakage Current, Reverse ( $V_{GS} = -20 \text{ Vdc}$ )	$I_{GSSR}$	–	–	-100	nA

**ON CHARACTERISTICS** (Note 2.)

Gate Threshold Voltage ( $V_{DS} = V_{GS}, I_D = 250 \mu\text{A}$ )	$V_{GS(th)}$	1.0	1.8	2.2	Vdc
On–State Drain Current ( $V_{DS} \geq 2.0 V_{DS(on)}, V_{GS} = 10 \text{ Vdc}$ )	$I_{D(on)}$	500	–	–	mA
Static Drain–Source On–State Voltage ( $V_{GS} = 10 \text{ Vdc}, I_D = 500 \text{ mA}$ ) ( $V_{GS} = 5.0 \text{ Vdc}, I_D = 50 \text{ mA}$ )	$V_{DS(on)}$	–	–	3.75 0.375	Vdc
Static Drain–Source On–State Resistance ( $V_{GS} = 10 \text{ V}, I_D = 500 \text{ mA}$ )  ( $V_{GS} = 5.0 \text{ Vdc}, I_D = 50 \text{ mA}$ )	$r_{DS(on)}$	–	–	4 4	Ohms
Forward Transconductance ( $V_{DS} \geq 2.0 V_{DS(on)}, I_D = 200 \text{ mA}$ )	$g_{FS}$	80	–	–	mmhos

**DYNAMIC CHARACTERISTICS**

Input Capacitance ( $V_{DS} = 25 \text{ Vdc}, V_{GS} = 0, f = 1.0 \text{ MHz}$ )	$C_{iss}$	–	17	50	pF
Output Capacitance ( $V_{DS} = 25 \text{ Vdc}, V_{GS} = 0, f = 1.0 \text{ MHz}$ )	$C_{oss}$	–	10	25	pF
Reverse Transfer Capacitance ( $V_{DS} = 25 \text{ Vdc}, V_{GS} = 0, f = 1.0 \text{ MHz}$ )	$C_{rss}$	–	2.5	5.0	pF

**SWITCHING CHARACTERISTICS** (Note 2.)

Turn–On Delay Time	( $V_{DD} = 25 \text{ Vdc}, I_D \cong 500 \text{ mA},$ $R_G = 25 \Omega, R_L = 50 \Omega, V_{gen} = 10 \text{ V}$ )	$t_{d(on)}$	–	7	20	ns
Turn–Off Delay Time		$t_{d(off)}$	–	11	40	ns

**BODY–DRAIN DIODE RATINGS**

Diode Forward On–Voltage ( $I_S = 115 \text{ mA}, V_{GS} = 0 \text{ V}$ )	$V_{SD}$	–	–	-1.5	Vdc
Source Current Continuous (Body Diode)	$I_S$	–	–	-115	mA
Source Current Pulsed	$I_{SM}$	–	–	-800	mA

2. Pulse Test: Pulse Width  $\leq 300 \mu\text{s}$ , Duty Cycle  $\leq 2.0\%$ .

L2N7002M3T5G , S-L2N7002M3T5G

TYPICAL ELECTRICAL CHARACTERISTICS

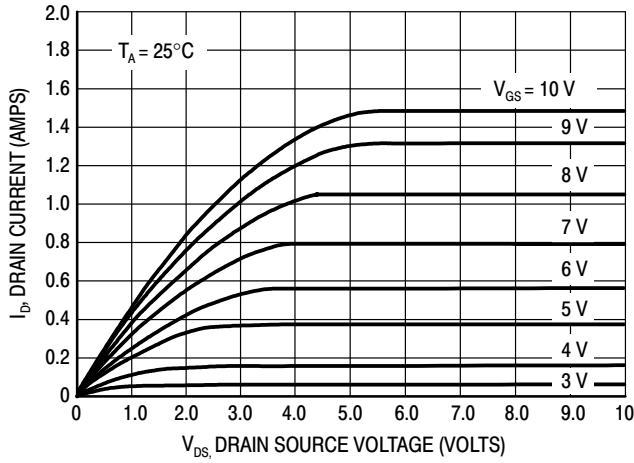

Figure 1. Ohmic Region

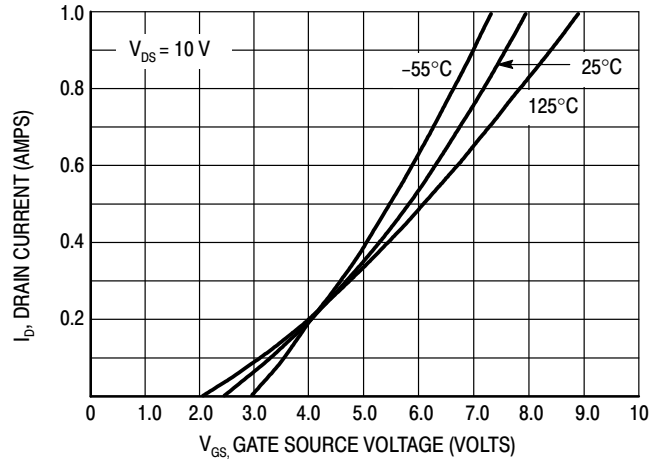

Figure 2. Transfer Characteristics

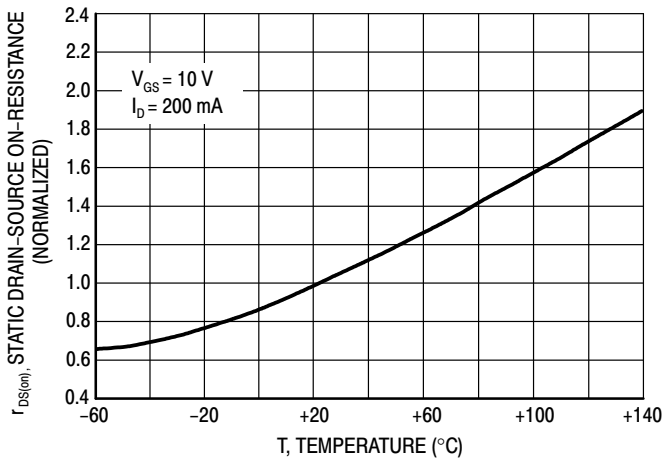

Figure 3. Temperature versus Static Drain-Source On-Resistance

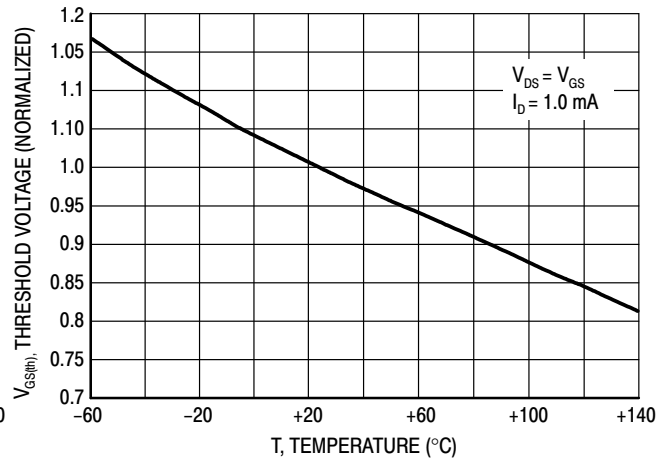
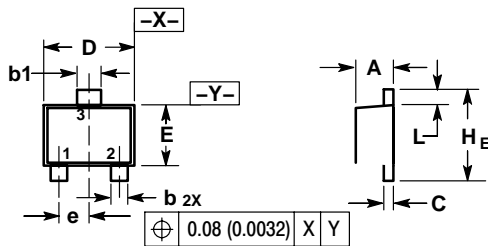
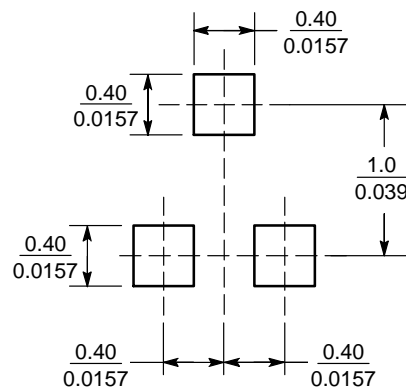

Figure 4. Temperature versus Gate Threshold Voltage

**SOT-723**

**NOTES:**

1. DIMENSIONING AND TOLERANCING PER ANSI Y14.5M, 1982.
2. CONTROLLING DIMENSION: MILLIMETERS.
3. MAXIMUM LEAD THICKNESS INCLUDES LEAD FINISH. MINIMUM LEAD THICKNESS IS THE MINIMUM THICKNESS OF BASE MATERIAL.
4. DIMENSIONS D AND E DO NOT INCLUDE MOLD FLASH, PROTRUSIONS OR GATE BURRS.

DIM	MILLIMETERS			INCHES		
	MIN	NOM	MAX	MIN	NOM	MAX
A	0.45	0.50	0.55	0.018	0.020	0.022
b	0.15	0.20	0.27	0.0059	0.0079	0.0106
b1	0.25	0.3	0.35	0.010	0.012	0.014
C	0.07	0.12	0.17	0.0028	0.0047	0.0067
D	1.15	1.20	1.25	0.045	0.047	0.049
E	0.75	0.80	0.85	0.03	0.032	0.034
e	0.40 BSC			0.016 BSC		
HE	1.15	1.20	1.25	0.045	0.047	0.049
L	0.15	0.20	0.25	0.0059	0.0079	0.0098

**SOLDERING FOOTPRINT**

( $\frac{\text{mm}}{\text{inches}}$ )