

DIGITRON SEMICONDUCTORS

2N4167-2N4174

SILICON CONTROLLED RECTIFIERS

MAXIMUM RATINGS

Rating	Symbol	Value	Unit
Peak repetitive forward and reverse blocking voltage 2N4167 2N4168 2N4169 2N4170 2N4172 2N4174	V_{DRM}, V_{RRM}	25 50 100 200 400 600	V
Forward current RMS	$I_{T(RMS)}$	8	A
Peak forward surge current (one cycle, 60Hz, $T_J = -40$ to $+100^\circ\text{C}$)	I_{TSM}	100	A
Circuit fusing ($t = 8.3\text{ms}$)	I^2t	40	A^2s
Peak gate power	P_{GM}	5	W
Average gate power	$P_{G(AV)}$	0.5	W
Peak gate current	I_{GM}	2	A
Peak gate voltage	V_{GM}	10	V
Operating temperature range	T_J	-40 to +100	$^\circ\text{C}$
Storage temperature range	T_{stg}	-40 to +150	$^\circ\text{C}$
Stud torque		15	In. lb.

THERMAL CHARACTERISTICS

Characteristic	Symbol	Typ.	Max	Unit
Thermal resistance, junction to case	$R_{\theta JC}$	1.5	2.5	$^\circ\text{C}/\text{W}$

ELECTRICAL CHARACTERISTICS ($T_C = 25^\circ\text{C}$, unless otherwise noted)

Characteristic	Symbol	Min	Typ	Max	Unit
Peak forward or reverse blocking current (Rated V_{DRM} or V_{RRM} , gate open) $T_C = 25^\circ\text{C}$ $T_C = 100^\circ\text{C}$	I_{DRM}, I_{RRM}	- -	- -	10 2	μA mA
Gate trigger current (continuous dc) ($V_D = 7\text{V}$, $R_L = 100\Omega$) ($V_D = 7\text{V}$, $R_L = 100\Omega$, $T_C = -40^\circ\text{C}$)	I_{GT}	- -	10 -	30 60	mA
Gate trigger voltage (continuous dc) ($V_D = 7\text{V}$, $R_L = 100\Omega$) ($V_D = 7\text{V}$, $R_L = 100\Omega$, $T_C = -40^\circ\text{C}$) ($V_D = 7\text{V}$, $R_L = 100\Omega$, $T_C = 100^\circ\text{C}$)	V_{GT}	- - 0.2	0.75 - -	1.5 2.5 -	V
Forward "on" voltage (pulsed, 1ms max., duty cycle $\leq 1\%$) ($I_{TM} = 15.7\text{A}$)	V_{TM}	-	1.4	2	V
Holding current ($V_D = 7\text{V}$, gate open) ($V_D = 7\text{V}$, gate open, $T_C = -40^\circ\text{C}$)	I_H	- -	10 -	30 60	mA
Turn-on time (t_d+t_r) ($I_G = 20\text{mA}$, $I_F = 5\text{A}$, $V_D = \text{rated } V_{DRM}$)	t_{on}	-	1	-	μs
Turn-off time ($I_F = 5\text{A}$, $I_R = 5\text{A}$) ($I_F = 5\text{A}$, $I_R = 5\text{A}$, $T_C = 100^\circ\text{C}$, $V_D = \text{rated } V_{DRM}$) ($dv/dt = 30\text{V}/\mu\text{s}$)	t_{off}	- -	15 25	- -	μs
Forward voltage application rate (exponential)	dv/dt				$\text{V}/\mu\text{s}$

DIGITRON SEMICONDUCTORS

(Gate open, $T_C = 100^\circ\text{C}$, $V_D = \text{rated } V_{DRM}$)

2N4167-2N4174

SILICON CONTROLLED RECTIFIERS

MECHANICAL CHARACTERISTICS

Case	TO-64
Marking	Alpha-numeric
Pin out	See below

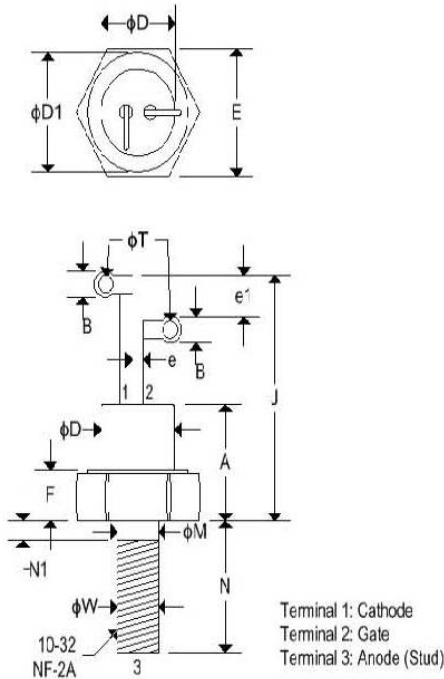

	TO-64			
	Inches		Millimeters	
	Min	Max	Min	Max
A	0.300	0.400	7.620	10.160
B	0.080	0.136	2.030	3.450
ΦD	-	0.424	-	10.770
ΦD_1	0.400	-	10.160	-
E	0.424	0.437	10.770	11.100
e	0.013	-	0.330	-
e_1	0.060	-	1.520	-
F	0.060	0.175	1.520	4.450
J	0.700	0.855	17.780	21.720
ΦM	0.163	0.189	4.140	4.800
N	0.400	0.453	10.160	11.510
N_1	-	0.078	-	1.980
ΦT	0.040	0.075	1.020	1.910
ΦW	0.1658	0.1697	4.212	4.310

Available Non-RoHS (standard) or RoHS compliant (add PBF suffix).
Available as "HR" (high reliability) screened per MIL-PRF-19500, JANTX level. Add "HR" suffix to base part number.

FIGURE 1 – PULSE CURRENT TRIGGERING

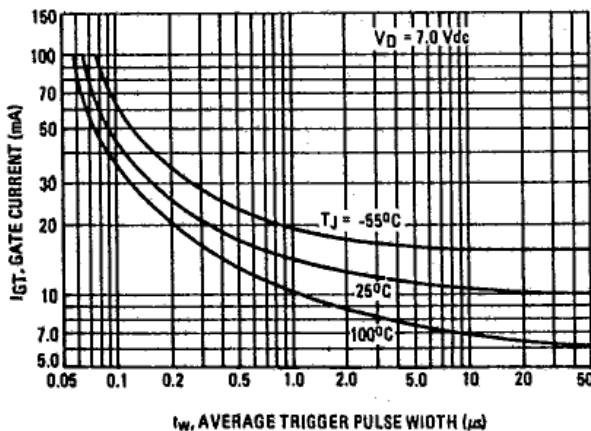
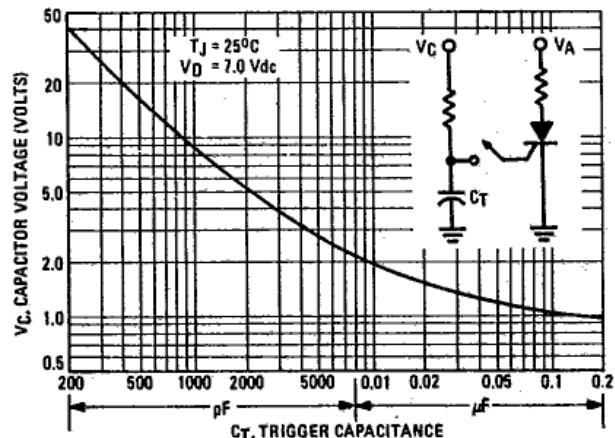

FIGURE 2 – CAPACITIVE DISCHARGE TRIGGERING



DIGITRON SEMICONDUCTORS

2N4167-2N4174

SILICON CONTROLLED RECTIFIERS

FIGURE 3 - MAXIMUM CASE TEMPERATURE

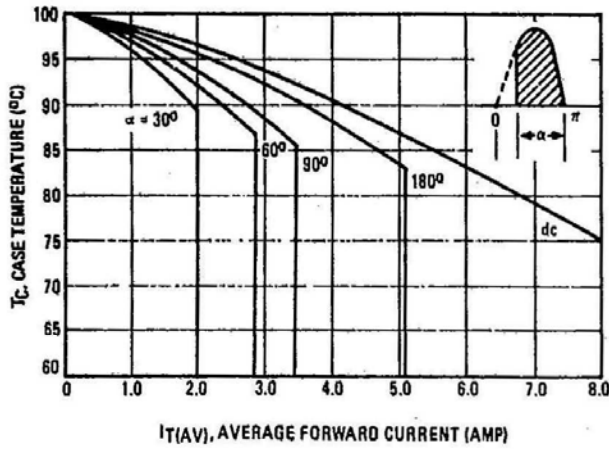

FIGURE 4 - MAXIMUM AMBIENT TEMPERATURE

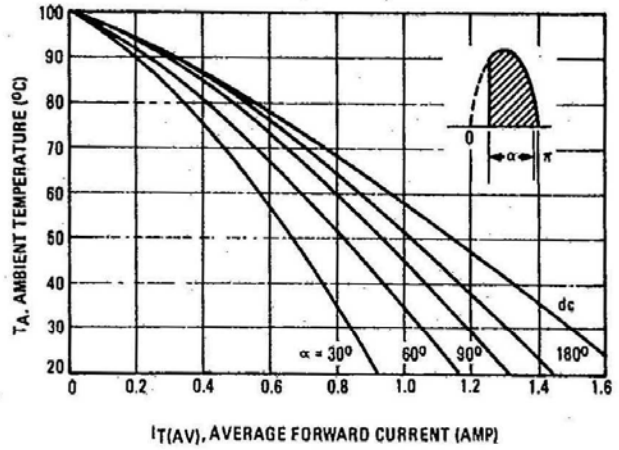

FIGURE 5 - POWER DISSIPATION

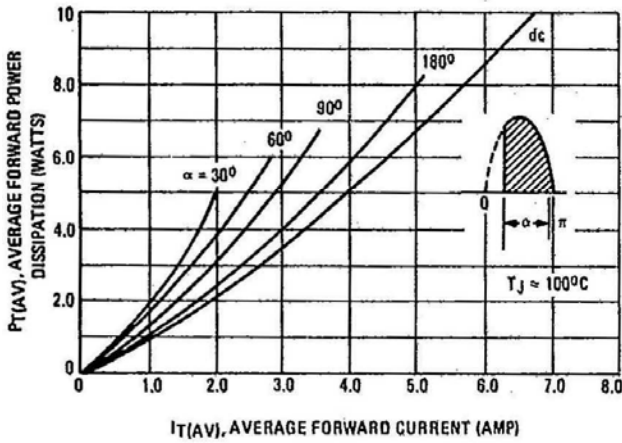

FIGURE 6 - MAXIMUM SURGE CAPABILITY

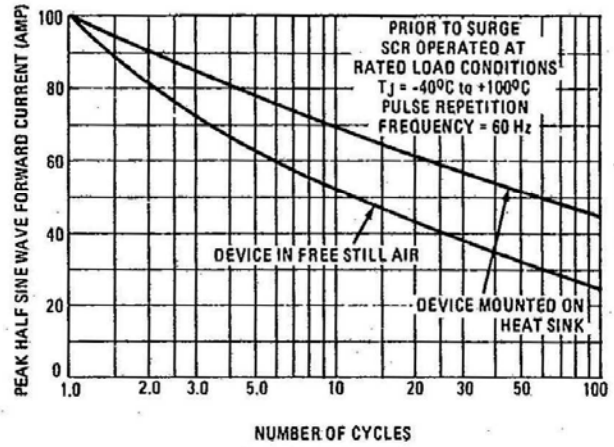
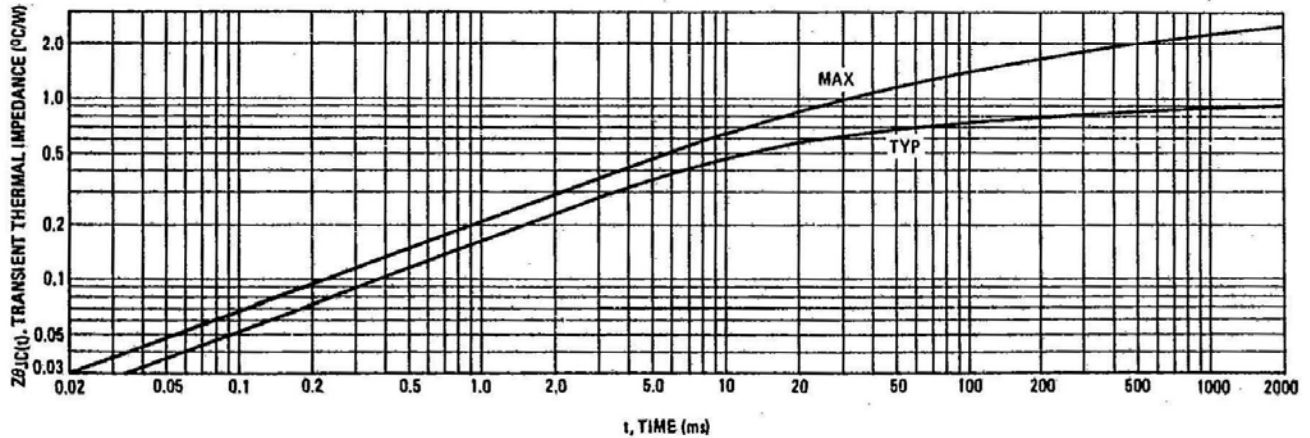

FIGURE 7 - THERMAL RESPONSE



DIGITRON SEMICONDUCTORS

2N4167-2N4174

SILICON CONTROLLED RECTIFIERS

FIGURE 8 – FORWARD VOLTAGE

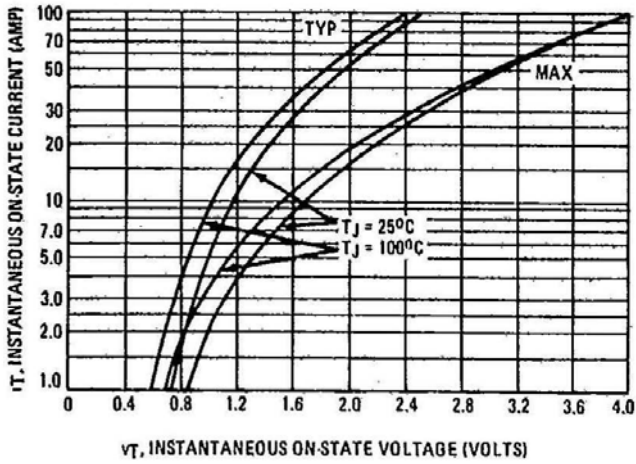

FIGURE 9 – HOLDING CURRENT

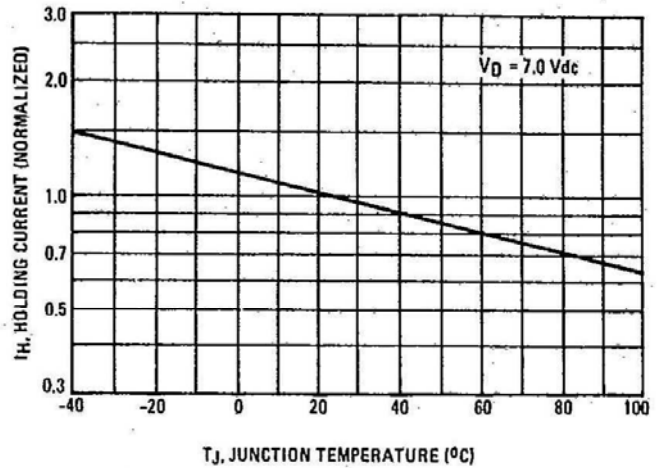

FIGURE 10 – TYPICAL THERMAL RESISTANCE OF PLATES

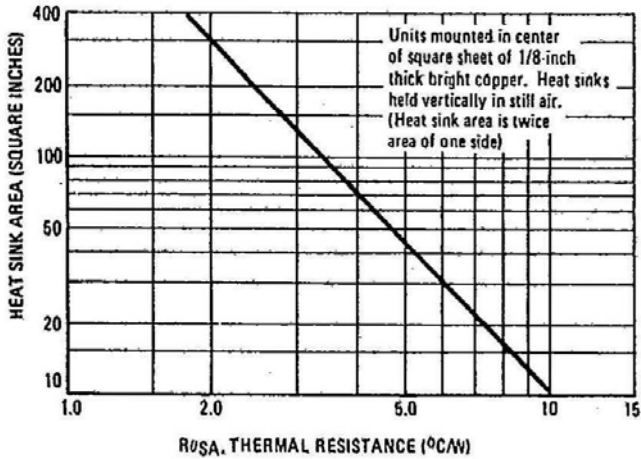

FIGURE 11 – CASE-TO-AMBIENT THERMAL RESISTANCE

