



## M20-050-24

### 2" Square / 50.8mm Square Waffle Tray (BLACK)

#### Features:

- Static Protective
- Tight Dimensional Pocket Tolerance
- Durable Material Construction

#### Component Applications:

- Thin Film & Chip Level / Known Good Die (KGD)
- Passive and Active Chip Components
- Opto Electronics and Mechanical Components

#### Waffle Tray Diagram

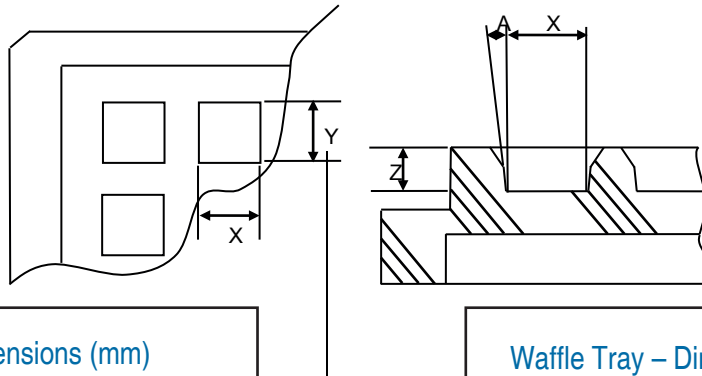

#### Waffle Tray - Dimensions (mm)

##### Technical Spec (mm)

X = 1.27mm ±0.13mm pocket size  
 Y = 1.27mm ±0.13mm pocket size  
 Z = 0.61mm ±0.08mm pocket depth  
 A = 3° ±1/2° pocket draft angle  
 No Cross Slots  
 Array = 20 X 20 (400)

##### Overall Tray Size:

Size = 50.67mm ±0.25mm  
 Height = 3.94mm +0.08mm -0.13mm  
 Flatness = 0.30mm

#### Waffle Tray – Dimensions (Inches)

##### Technical Spec (inches)

X = 0.050" ±0.005" pocket size  
 Y = 0.050" ±0.005" pocket size  
 Z = 0.024" ±0.003" pocket depth  
 A = 3° ±1/2° pocket draft angle  
 No Cross Slots  
 Array = 20 X 20 (400)

##### Overall Tray Size:

Size = 1.995" ±0.010"  
 Height = 0.155" +0.003" -0.005"  
 Flatness = 0.012"

**Buy M20-050-24 Waffle Tray Pack Online**

**Micross Kit Includes – Tray, Lid, Tyvek Paper and Clip**

Tray Material	Polypropylene with Carbon Powder and Glass Bead
Surface Resistivity	10 <sup>1</sup> - 10 <sup>5</sup>
Static Delay Time (sec.)	<0.01
Temperature Limit	70°C
Lid Material	Polypropylene with Carbon Powder and Glass Bead
Clip Material	Polypropylene with Carbon Powder