

Service

Service

Service



Service Manual

TABLE OF CONTENTS

	Page
Specification.....	1-2
Safety Instruction, Warning & Notes.....	1-3
Mechanical and Dismantling Instruction.....	2-1
Software Upgrades.....	3-1
Trouble Shooting	4-1
Wiring Diagram.....	5-1
Electrical Diagram and Print-layout.....	6-1
Mechanical Exploded View.....	7-1
Revision List.....	8-1

© Copyright 2011 Philips Consumer Electronics B.V. Eindhoven, The Netherlands
All rights reserved. No part of this publication may be reproduced, stored in a retrieval system or transmitted, in any form or by any means, electronic, mechanical, photocopying, or otherwise without the prior permission of Philips.



Safety instruction, Warning & Notes

Safety instruction

1. General safety

Safety regulations require that during a repair:

- . Connect the unit to the mains via an isolation transformer.
- . Replace safety components indicated by the symbol ▲, only by components identical to the original ones. Any other component substitution (other than original type) may increase risk of fire or electrical shock hazard.

Safety regulations require that after a repair, you must return the unit in its original condition. Pay, in particular, attention to the following points:

- . Route the wires/cables correctly, and fix them with the mounted cable clamps.
- . Check the insulation of the mains lead for external damage.
- . Check the electrical DC resistance between the mains plug and the secondary side:
 - 1) Unplug the mains cord, and connect a wire between the two pins of the mains plug.
 - 2) Set the mains switch the "on" position (keep the mains cord unplug).
 - 3) Measure the resistance value between the mains plug and the front panel, controls, and chassis bottom.
 - 4) Repair or correct unit when the resistance measurement is less than 1M Ω .
 - 5) Verify this, before you return the unit to the customer/user (ref. UL-standard no. 1492).
 - 6) Switch the unit "off", and remove the wire between the two pins of the mains plug.

2.Laser safety

This unit employs a laser. Only qualified service personnel may remove the cover, or attempt to service this device (due to possible eye injury).

Laser device unit

Type	: Semiconductor laser GaAlAs
Wavelength	: 650nm (DVD)
	: 780nm (VCD/CD)
Output power	: 7mW (DVD)
	: 10mW (DVD /CD)

Beam divergence: 60 degree

Note: Use of controls or adjustments or performance of procedure other than those specified herein, may result in hazardous radiation exposure. Avoid direct exposure to beam.

Warning

1. General

. All ICs and many other semiconductors are susceptible to electrostatic discharges (ESD). Careless handling during repair can reduce life drastically. Make sure that, during repair, you are at the same potential as the mass of the set by a wristband with resistance. Keep components and tools at this same potential. Available ESD protection equipment:

- 1) Complete kit ESD3 (small tablemat, wristband, connection box, extension cable and earth cable) 4822 310 10671.
- 2) Wristband tester 4822 344 13999.

. Be careful during measurements in the live voltage section. The primary side of the power supply, including the heat sink, carries live mains voltage when you connect the player to the mains (even when the player is "off!"). It is possible to touch copper tracks and/or components in this unshielded primary area, when you service the player. Service personnel must take precautions to prevent touching this area or components in this area. A "lighting stroke" and a stripe-marked printing on the printed wiring board, indicate the primary side of the power supply.

. Never replace modules, or components, while the unit is "on".

2. Laser

- . The use of optical instruments with this product, will increase eye hazard.
- . Only qualified service personnel may remove the cover or attempt to service this device, due to possible eye injury.
- . Repair handling should take place as much as possible with a disc loaded inside the player.
- . Text below is placed inside the unit, on the laser cover shield:

CAUTION: VISIBLE AND INVISIBLE LASER RADIATION WHEN OPEN, AVOID EXPOSURE TO BEAM.

Notes: Manufactured under licence from Dolby Laboratories. The double-D symbol is trademarks of Dolby Laboratories, Inc. All rights reserved.

Service Hints

CAUTION

CHARGED CAPACITORS ON THE SERVO BOARD MAY DAMAGE THE DRIVE ELECTRONICS WHEN CONNECTING A NEW DRIVE. THAT'S WHY, BESIDES THE SAFETY MEASURES LIKE

- SWITCH OFF POWER SUPPLY
- ESD PROTECTION

ADDITIONAL ACTIONS MUST BE TAKEN BY THE REPAIR TECHNICIAN.

The following steps have to be done when replacing the defective loader :

1. Dismantling of the loader to access the ESD protection point if necessary.
2. **Solder the ESD protection point***.
3. Disconnect flexfoil cable from the defective loader.
4. Put a paper clip on the flexfoil to short-circuit the contacts (fig.1)
5. Replace the defective loader with a new loader.
6. Remove paperclip from the flexfoil and connect it to the new loader.
7. Remove solder joint on the ESD protection point.

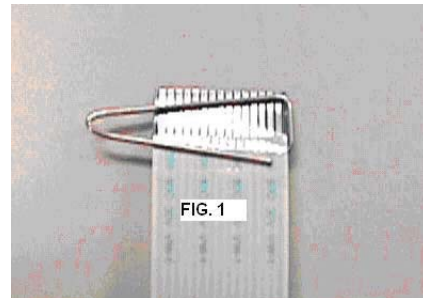

ATTENTION: The laser diode of this loader is protected against ESD by a solder joint which shortcircuits the laserdiode to ground. For proper functionality of the loader this solder joint must be remove **after** connection loader to the set.

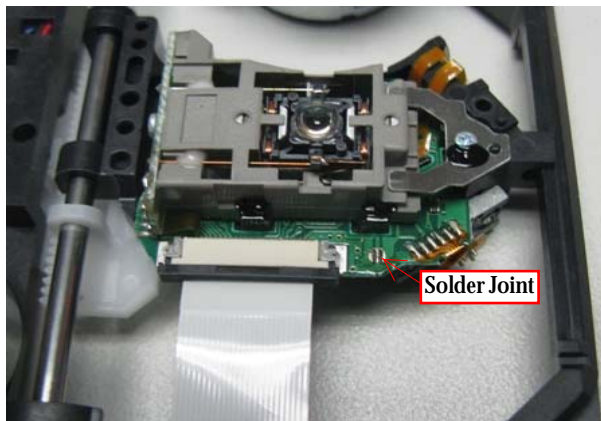

(ESD protection point is accessible from top of loader)

****Only applicable for defective loader needed to be sent back to supplier for failure analysis and to support backcharging evidence.***

This is also applicable for all partnership workshops.

Notes

Lead-Free requirement for service

IDENTIFICATION:

Regardless of special logo (not always indicated) 

One must treat all sets from 1.1.2005 onwards, according next rules.

Important note: In fact also products a little older can also be treated in this way as long as you avoid mixing solder-alloys (leaded/ lead-free). So best to always use SAC305 and the higher temperatures belong to this.

Due to lead-free technology some rules have to be respected by the workshop during a repair:

- Use only lead-free solder alloy Philips SAC305 with order code 0622 149 00106. If lead-free solder-paste is required, please contact the manufacturer of your solder-equipment. In general use of solder-paste within workshops should be avoided because paste is not easy to store and to handle.
- Use only adequate solder tools applicable for lead-free solder alloy. The solder tool must be able
 - To reach at least a solder-temperature of 400°C,
 - To stabilize the adjusted temperature at the solder-tip
 - To exchange solder-tips for different applications.
- Adjust your solder tool so that a temperature around 360°C – 380°C is reached and stabilized at the solder joint. Heating-time of the solder-joint should not exceed ~ 4 sec. Avoid temperatures above 400°C otherwise wear-out of tips will rise drastically and flux-fluid will be destroyed. To avoid wear-out of tips switch off un-used equipment, or reduce heat.
- Mix of lead-free solder alloy / parts with leaded solder alloy / parts is possible but PHILIPS recommends strongly to avoid mixed solder alloy types (leaded and lead-free). If one cannot avoid, clean carefully the solder-joint from old solder alloy and re-solder with new solder alloy (SAC305).

- Use only original spare-parts listed in the Service-Manuals. Not listed standard-material (commodities) has to be purchased at external companies.
- Special information for BGA-ICs:
 - always use the 12nc-recognizable soldering temperature profile of the specific BGA (for de-soldering always use highest lead-free temperature profile, in case of doubt)
 - lead free BGA-ICs will be delivered in so-called 'dry-packaging' (sealed pack including a silica gel pack) to protect the IC against moisture. After opening, dependent of MSL-level seen on indicator-label in the bag, the BGA-IC possibly still has to be baked dry. This will be communicated via AYS-website.
- Do not re-use BGAs at all.
- For sets produced before 1.1.2005, containing leaded soldering-tin and components, all needed spare-parts will be available till the end of the service-period. For repair of such sets nothing changes.
- On our website:

www.atyourservice.ce.Philips.com

You find more information to:

BGA-de-/soldering (+ baking instructions)
Heating-profiles of BGAs and other ICs used in Philips-sets

You will find this and more technical information within the "magazine", chapter "workshop news".
For additional questions please contact your local repair-helpdesk.

PCB Location:

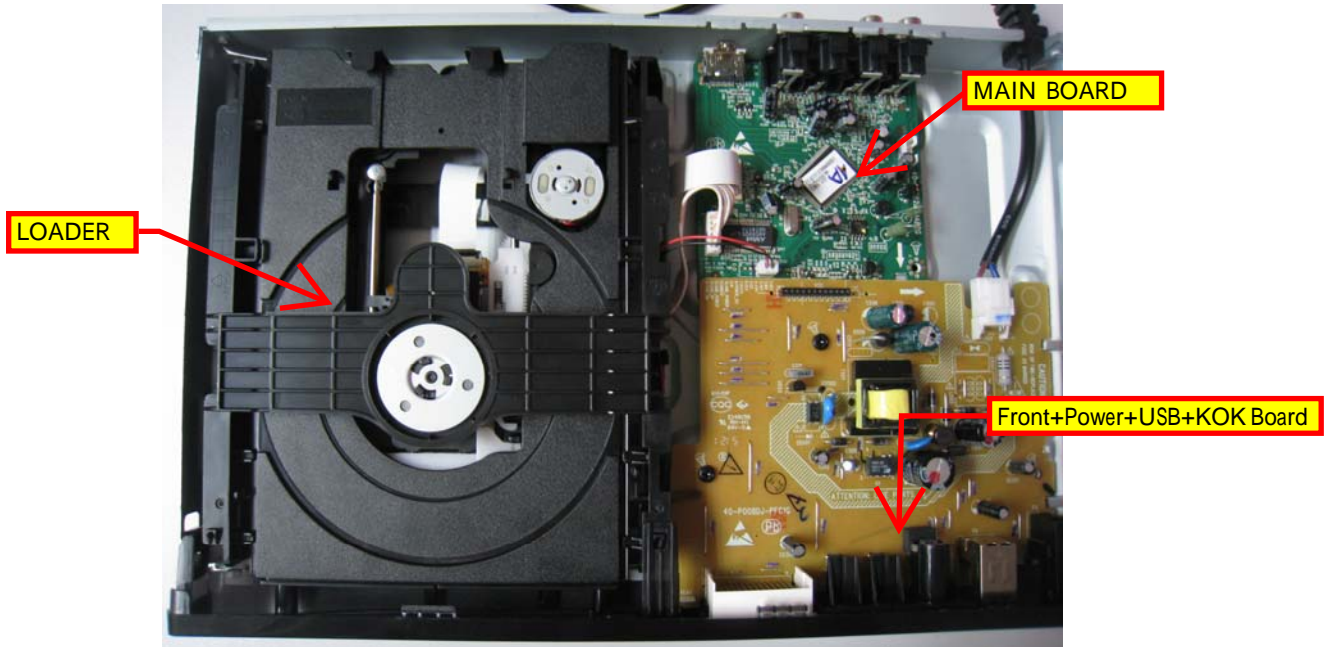

Repair Scenario Matrix

Type/Versions Board in used	DVP3680KX
	177178
Main Board	C/M
Front&Power&USB Board	C/M

*M:Module Level Repair

*C:Component Level Repair

*X:Used

Mechanical and Dismantling Instructions

Dismantling Instruction

Detailed information please refer to the model set.

The following guidelines show how to dismantle the player.

Step1: Remove 5 screws around the Top Cover, and then remove the Top Cover (Figure 1).

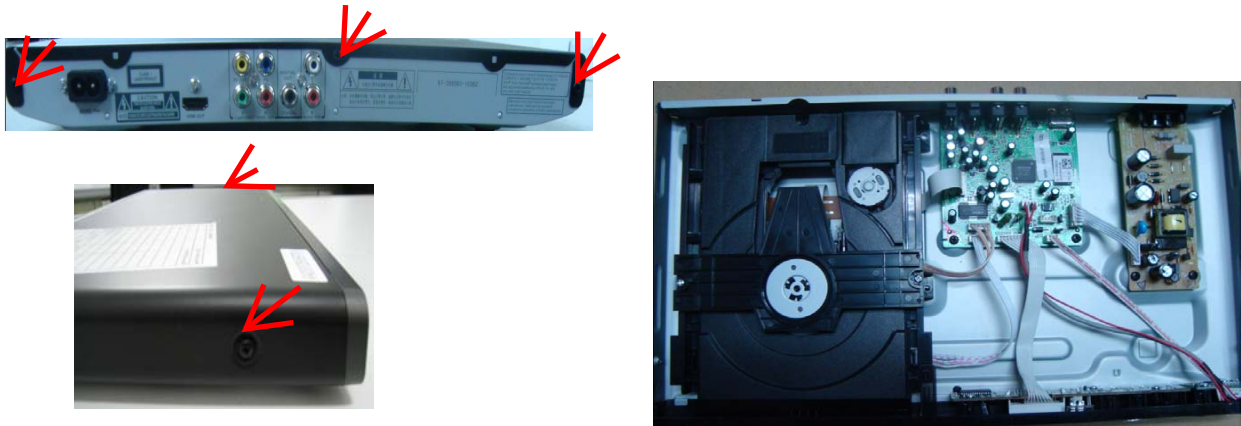

The sample is DVP3880K/98.

Figure 1

Step2: If it is necessary to dismantle Loader or Front Panel, the Front door should be removed first. (Figure 2)

Note: Make sure to operate gently otherwise the guider would be damaged.



Please kindly note that dismantle the front door assembly carefully to avoid damage tray and the front door.

Figure 2

Mechanical and Dismantling Instructions

Dismantling Instruction

Detailed information please refer to the model set.

Step3: If the tray can't open in normal way, you can make it through the instruction as below (Figure 3).

Note: Make sure to operate gently otherwise the guider would be damaged.



Figure 3

Step4: Dismantling Front Panel, disconnect the connectors (XP5, XP6,XP7), need release 4 snaps of Front Panel & 2 snaps of bottom cabinet , then gently pull the Panel out from the set. (Figure 4 - Figure 6)

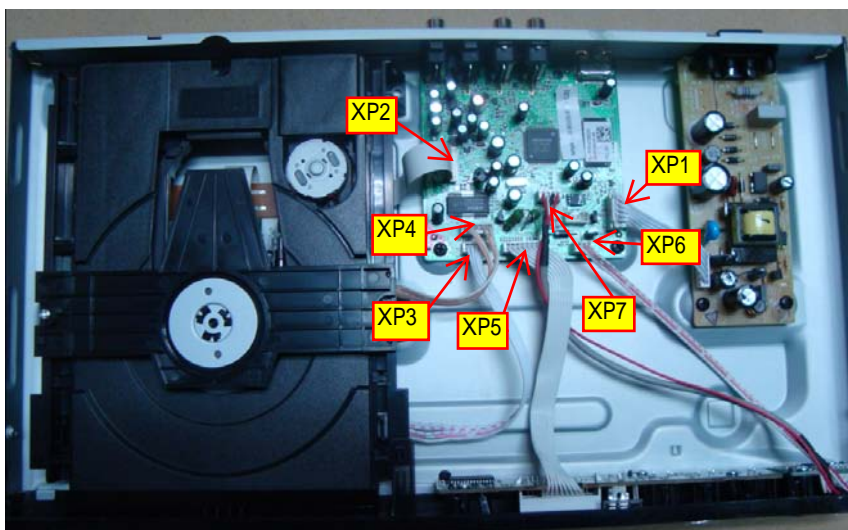

Figure 4

Mechanical and Dismantling Instructions

Dismantling Instruction

Detailed information please refer to the model set.

Step5: Dismantling Loader, disconnect the 3 connectors (XP2, XP3, XP4) aiming in the below figure, and remove 1 screw that connects the loader and the bottom cabinet. (Figure 5)

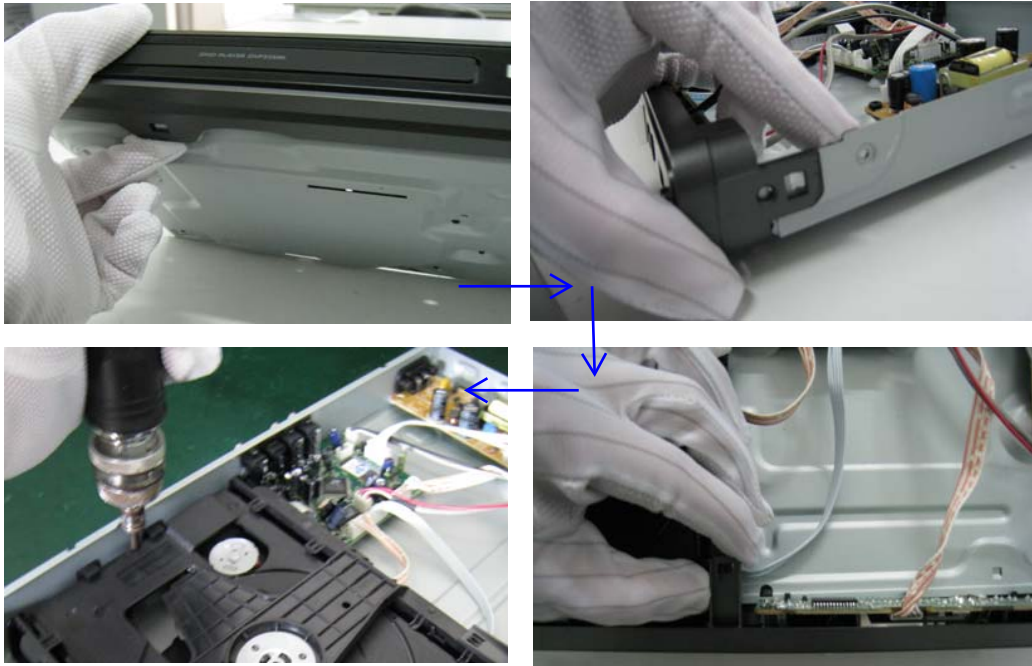

Figure 5

Step6: Dismantling Main Board, first disconnect the connector (XP1), and then remove 5 screws. (Figure 6)

Step7: Remove the 4 screws on Power Board to dismantle the Power Board. (Figure 6)

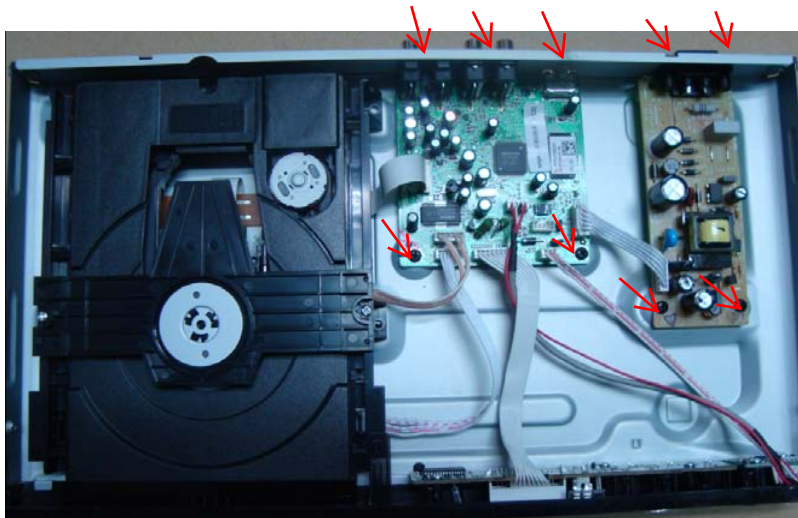

Figure 6

Software upgrade

Preparation to upgrade software

- 1) Start the CD Burning software and create a new CD project (Data Disc) with the following setting:

Label: DVP3XXX (No need the label name)

File Name: DVPXXXX_XX.BIN

Power on the set and open the tray, then press <option> to check the File Name.

Note: It is required capital letter for the File System name

- 2) Burn the data onto a blank CDR

A. Procedure for software upgrade:

- 1) Power on the set and insert the prepared Upgrade CDR.
- 2) The set will starts reading disc & response with the following display TV screen:

Upgrade file detected

VXX(SW VER)

<X>

<O>

- 3) Press <OK> button to confirm, then screen will display :

Upgrade file detected

UPGRADING...

Do not power off...

- 4) The upgraded tray will automatically open when files coping complete, then take out the disc.
- 5) About 1 minute later, the trace will automatically close when upgrading complete.

B. Read out the software versions to confirm upgrading

- 1) Power on the set and press <Setup> button on the remote control.
- 2) Press <Up><Next>< Up >< Up ><OK> button.

The software version and other information are display on the TV screen as follows:

Model	DVP3XXX_XX
File Name	DVPXXXX_XX.BIN
Version	XX.XX.XX.XX
8203RX	XX.XX.XX.XX
RISC	XXXXXX-XXX-XXX
Servo	XXXXX-XXX-XXXX
Region Code	X

Caution: The set must not be power off during upgrading, Otherwise the Main board will be damaged entirely.

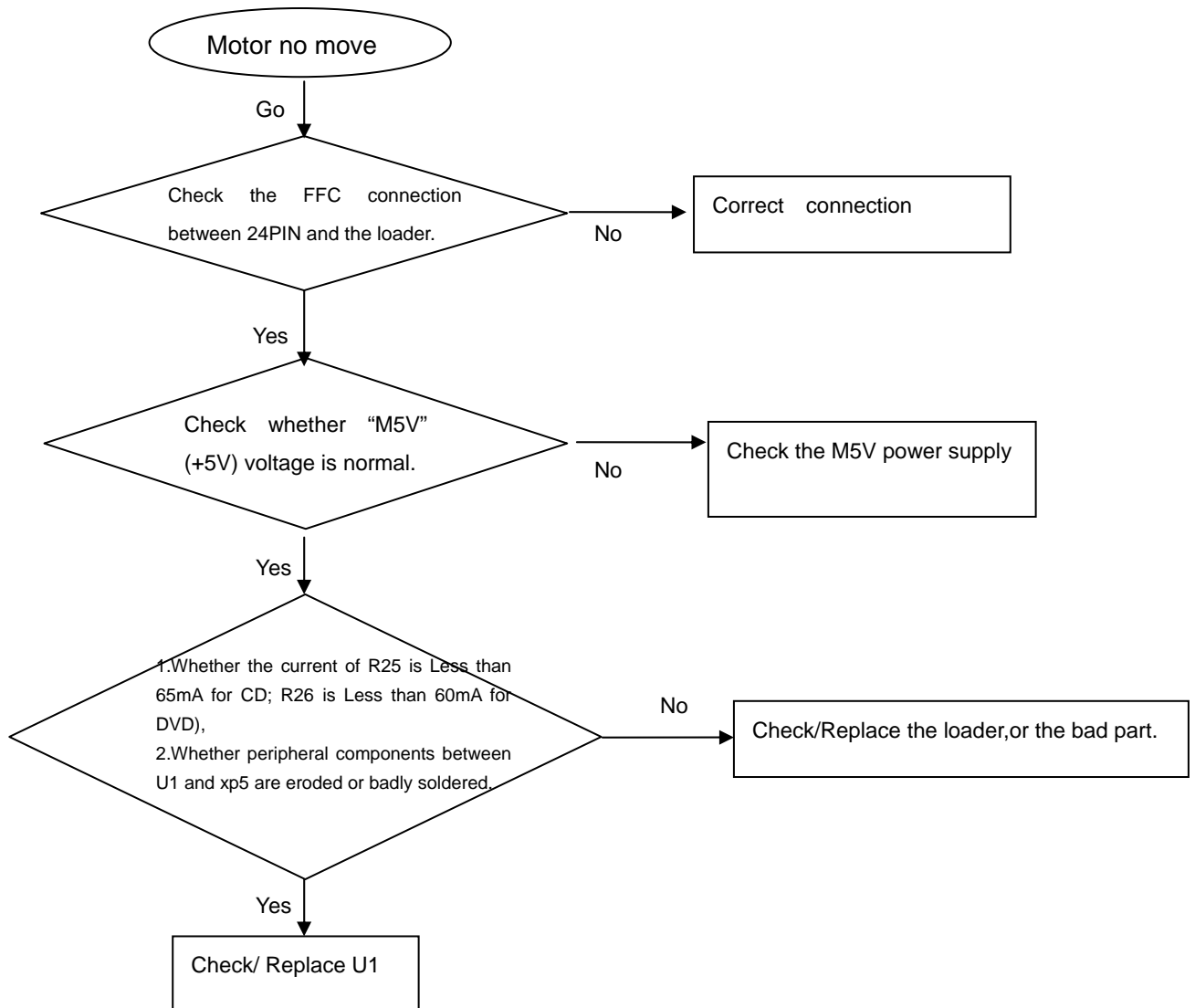
Spindle motor does not move

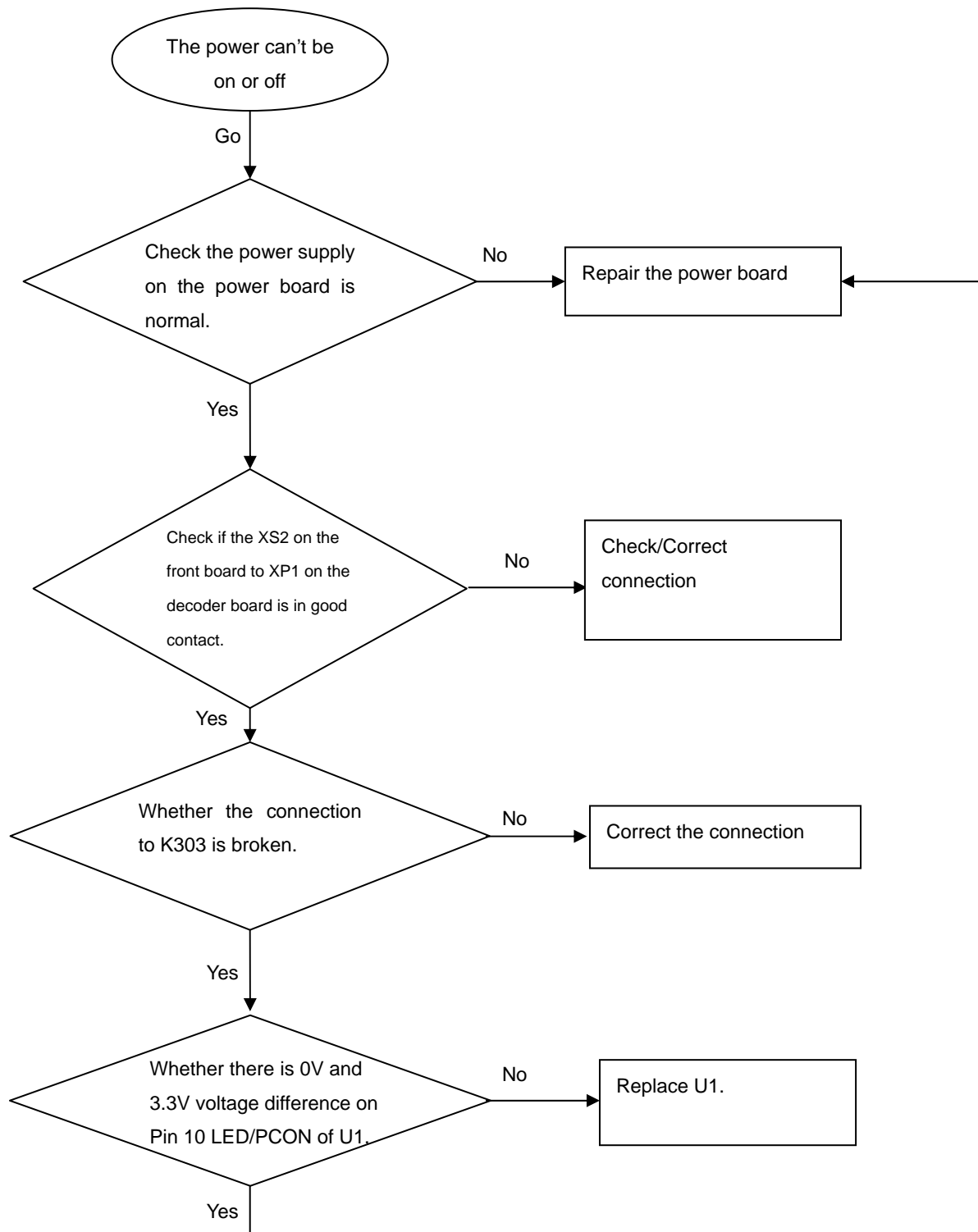
The power can not be on or off

All output voltages on the power board is 0V or deviated.

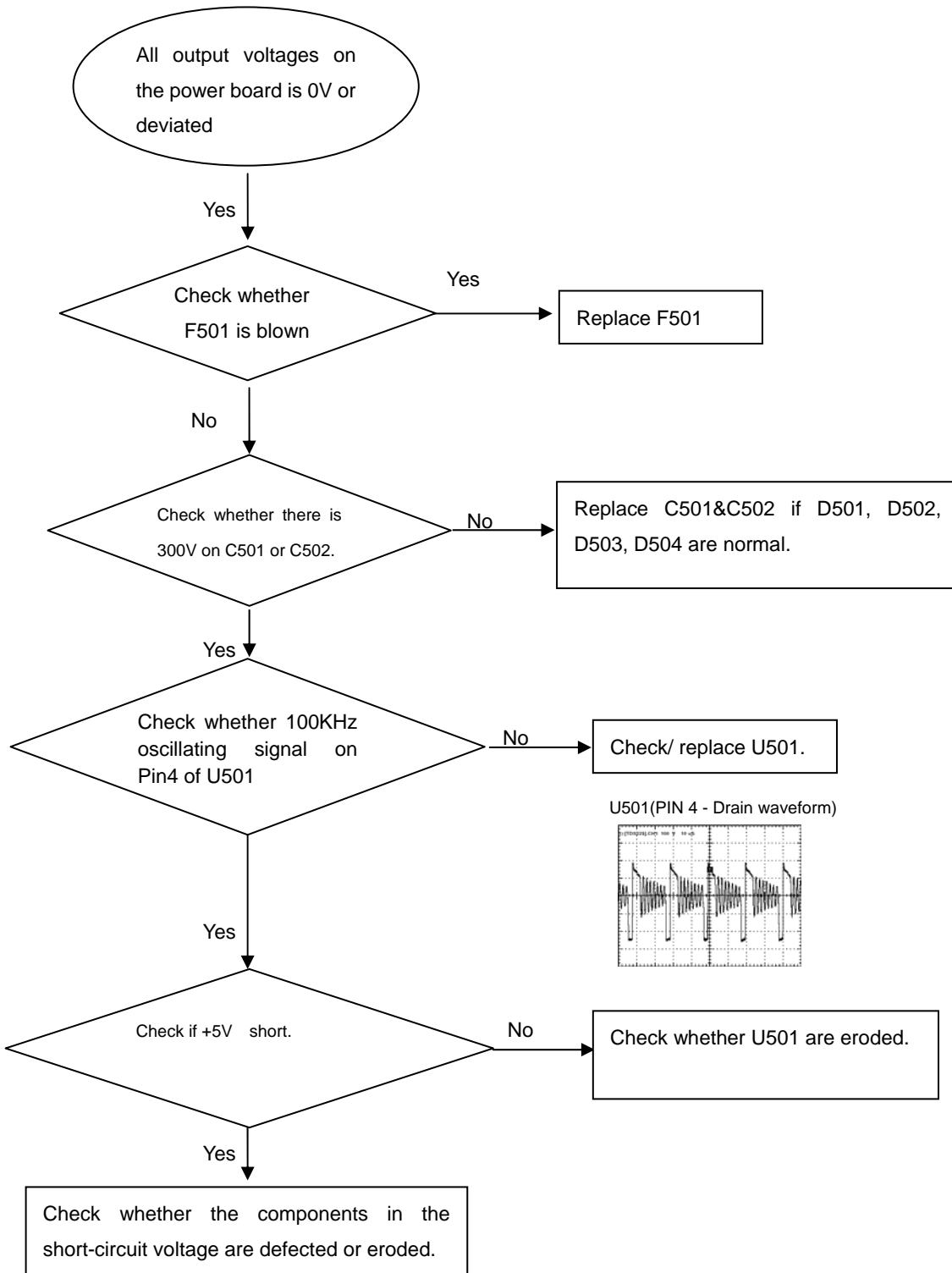

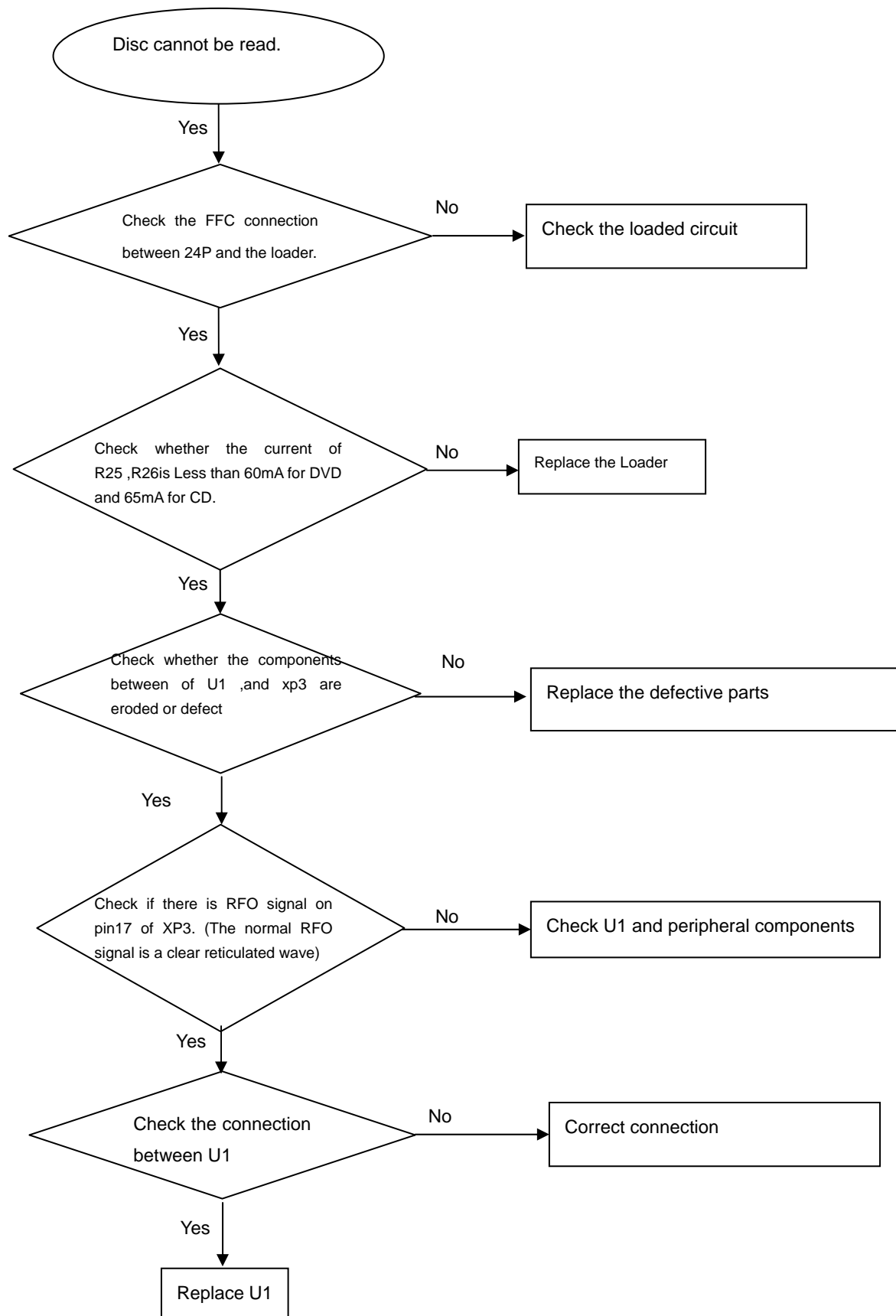
Disc cannot be read.

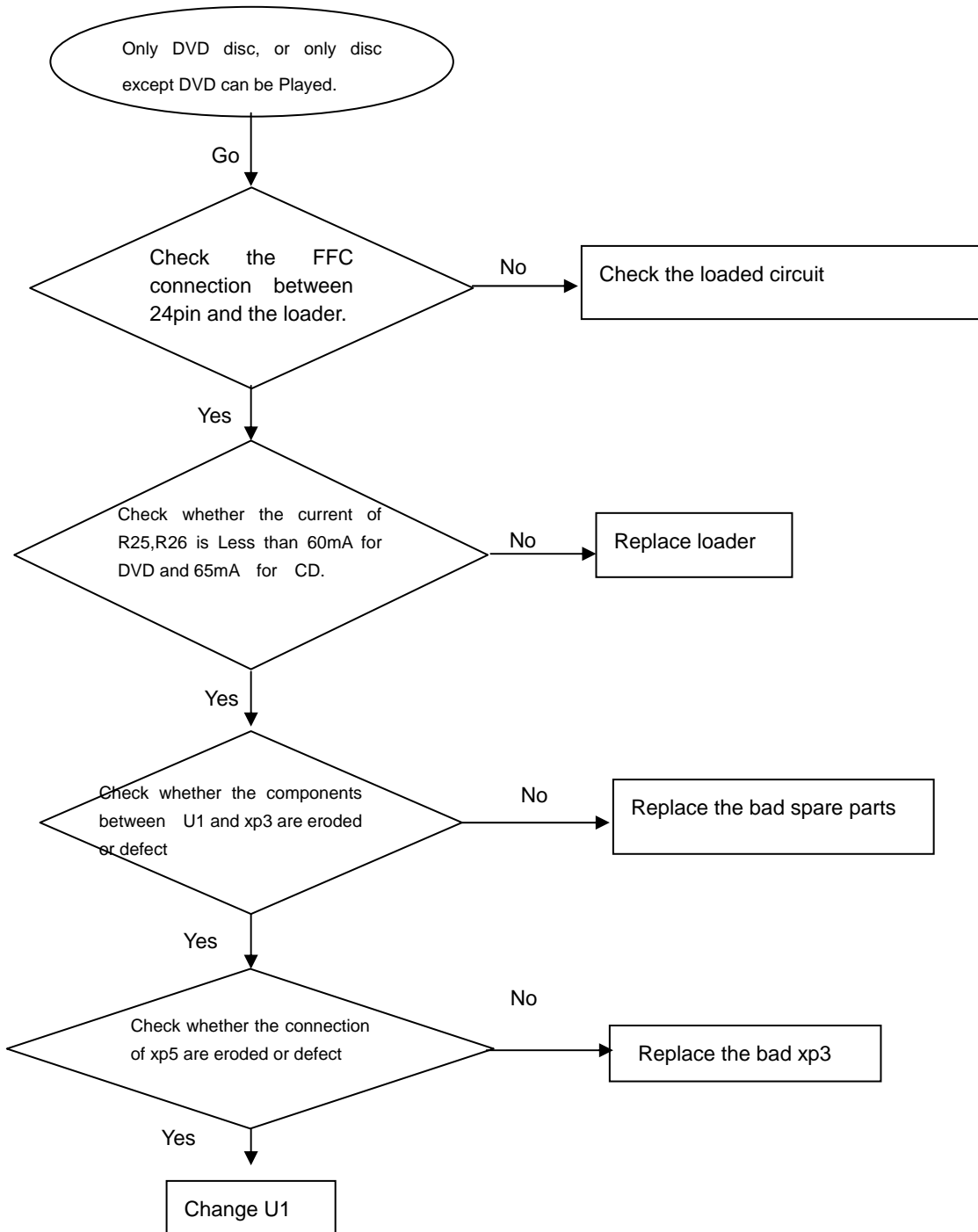
Only DVD disc or only disc except DVD can be played

No display on LED, and buttons do not work

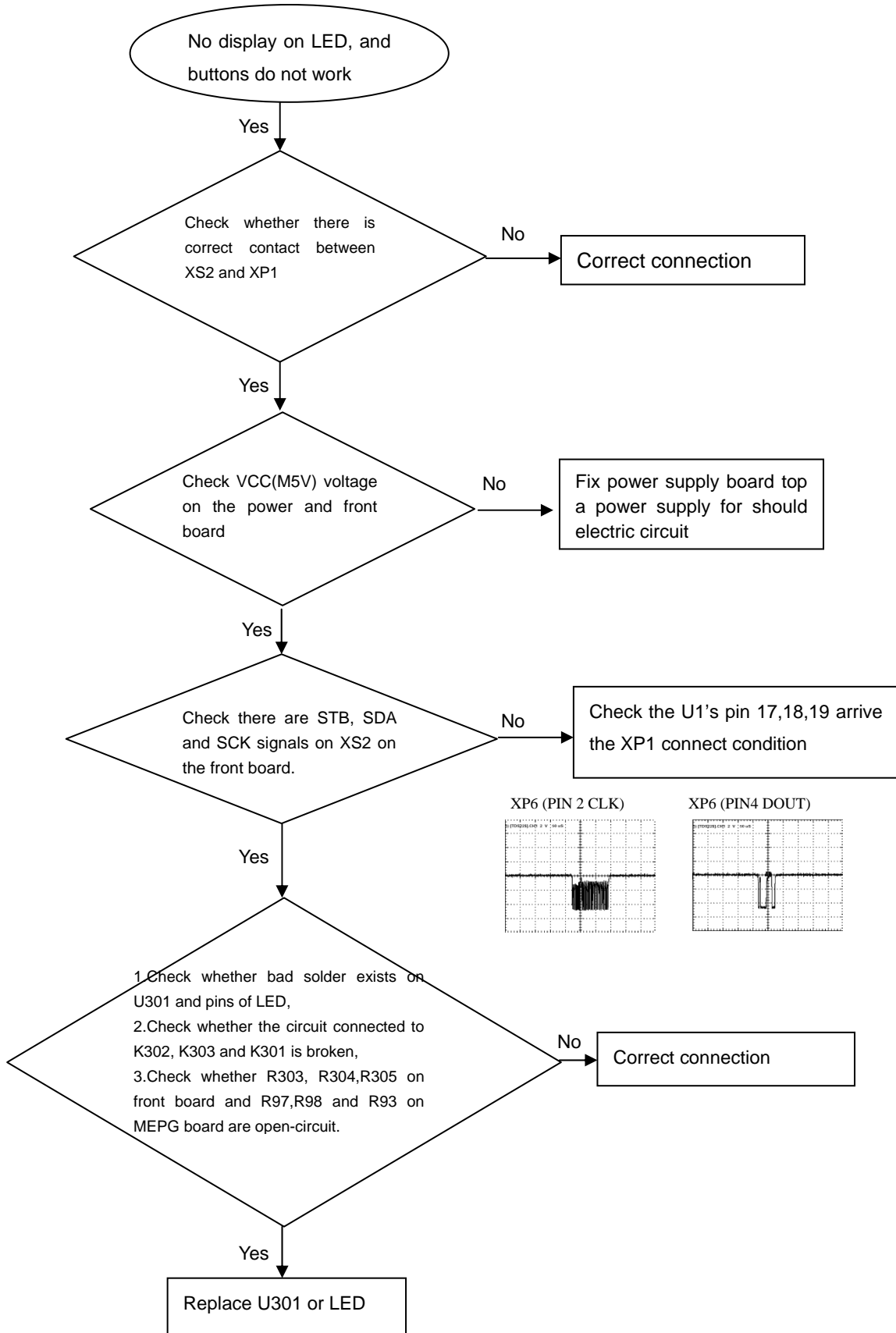

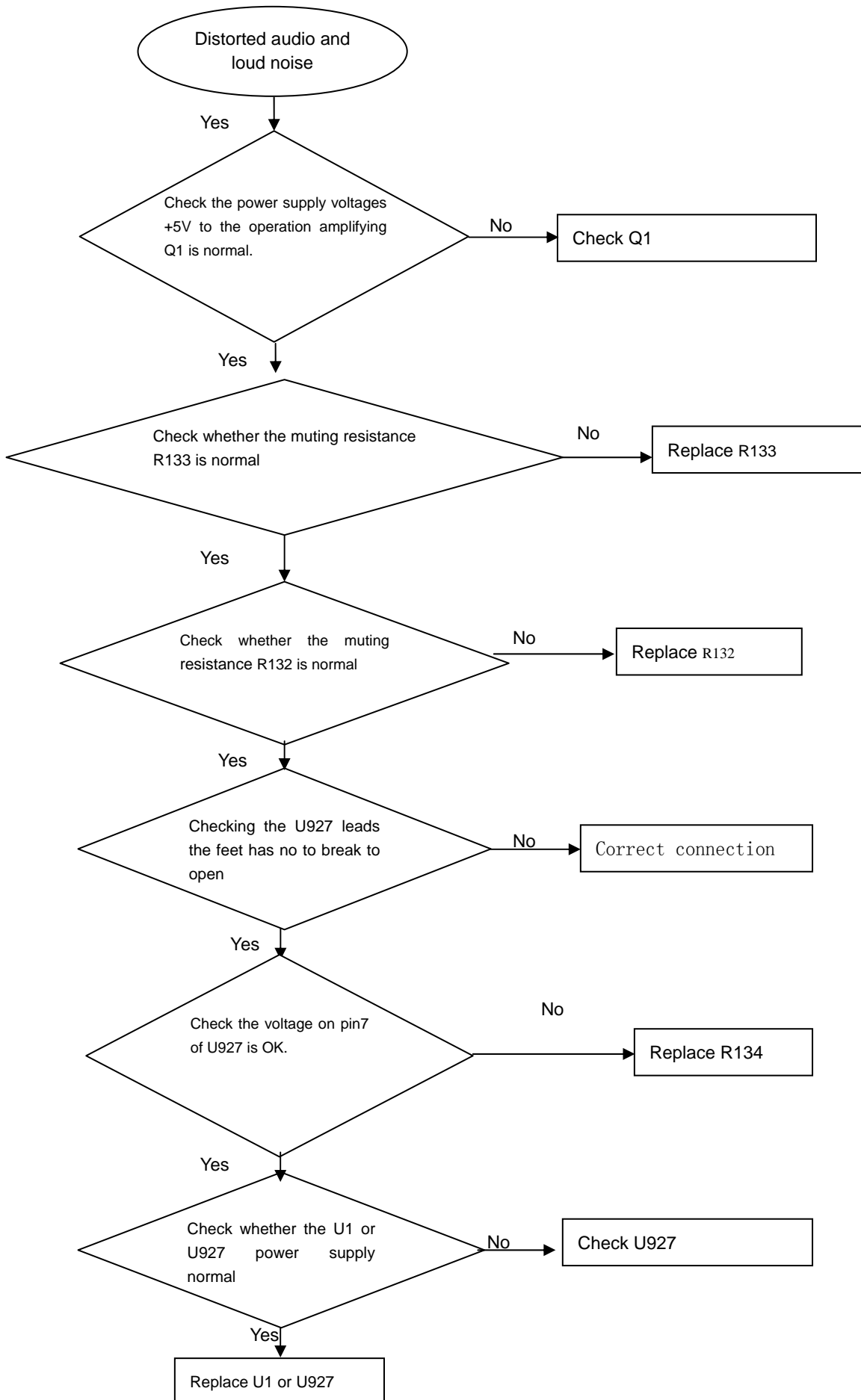
Distorted audio and loud noise

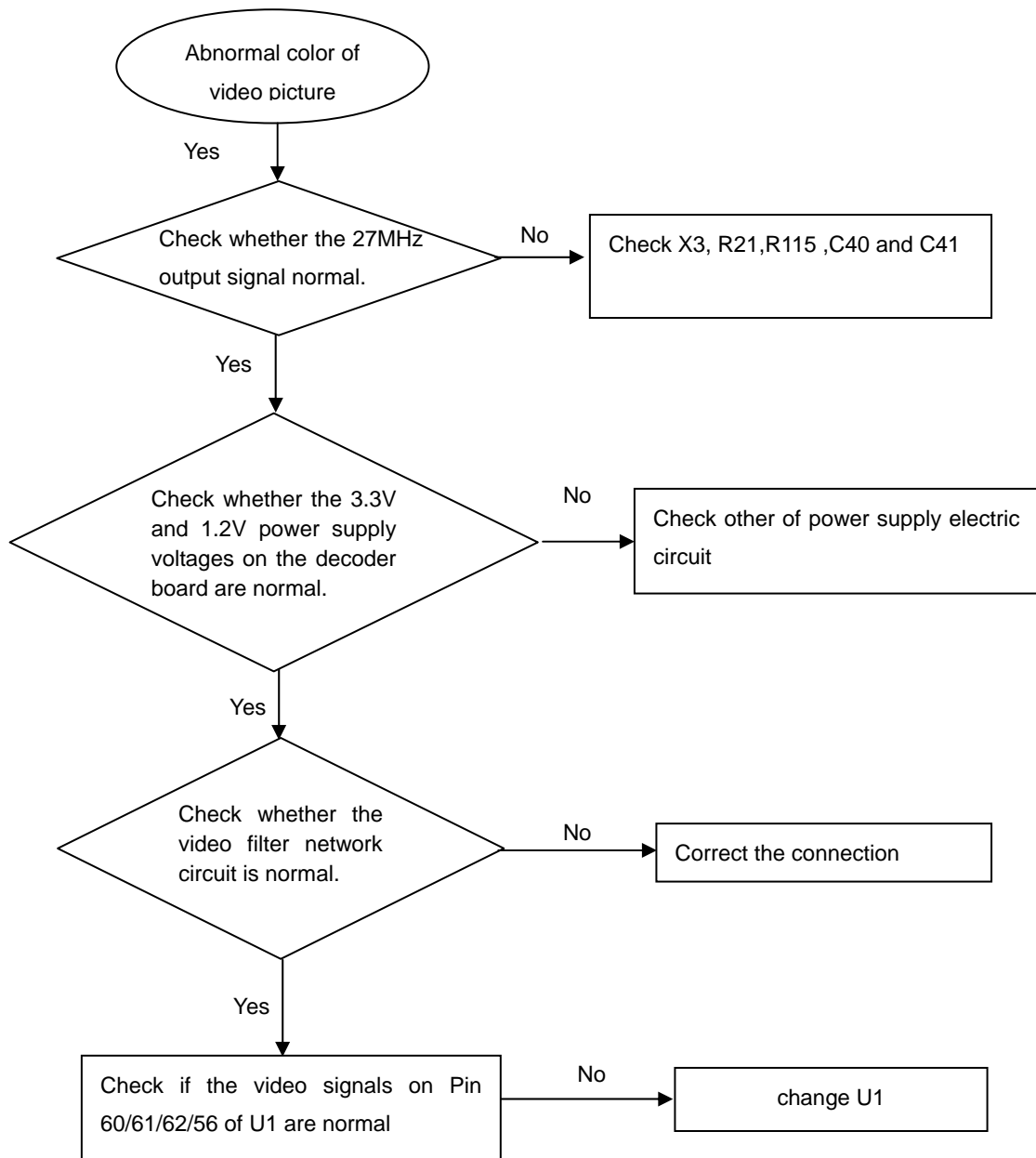
Abnormal color of video picture

Remote reception is insensitive or fails.

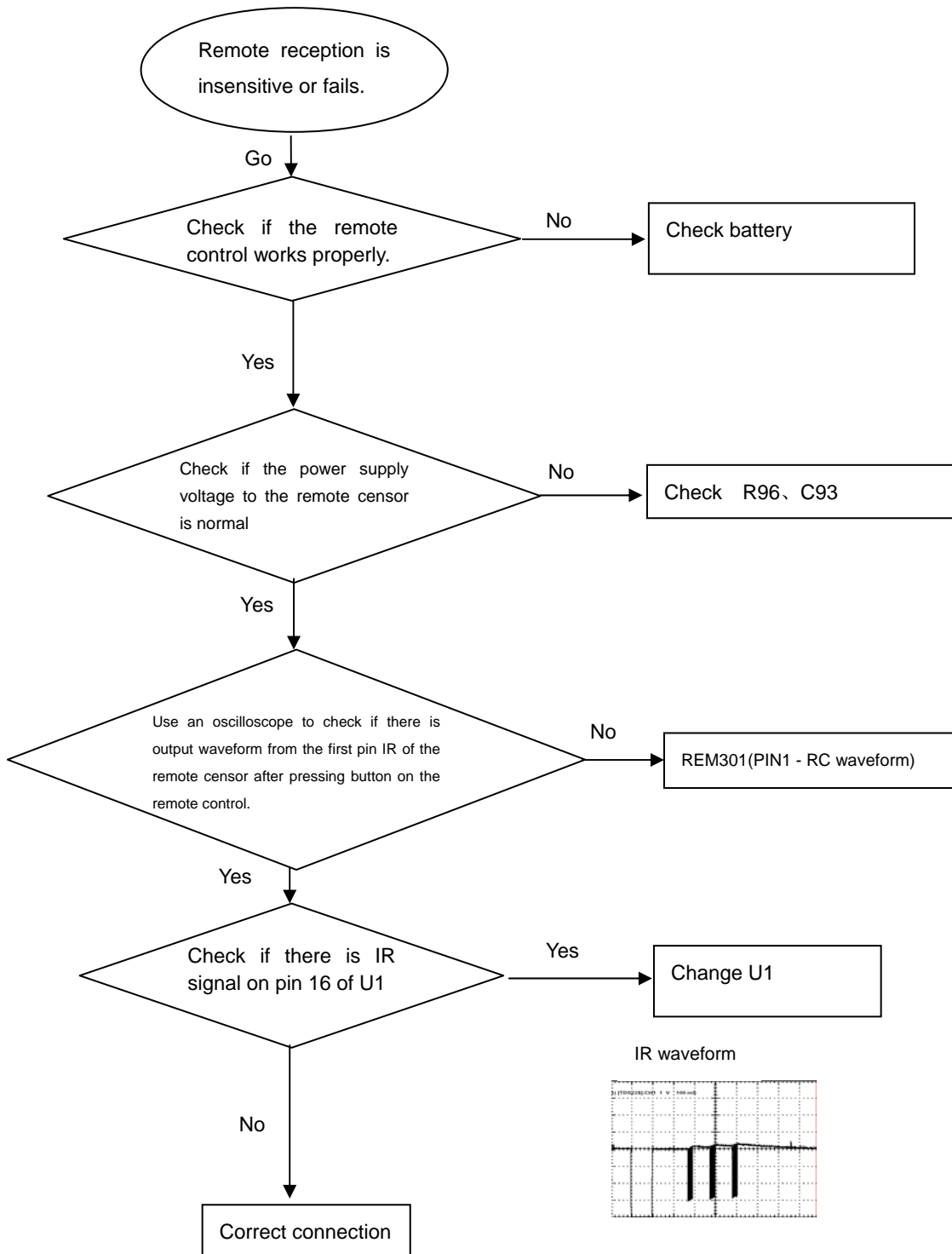

IR waveform

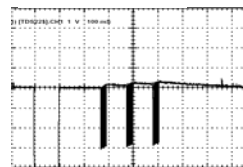

No video picture, no sound.

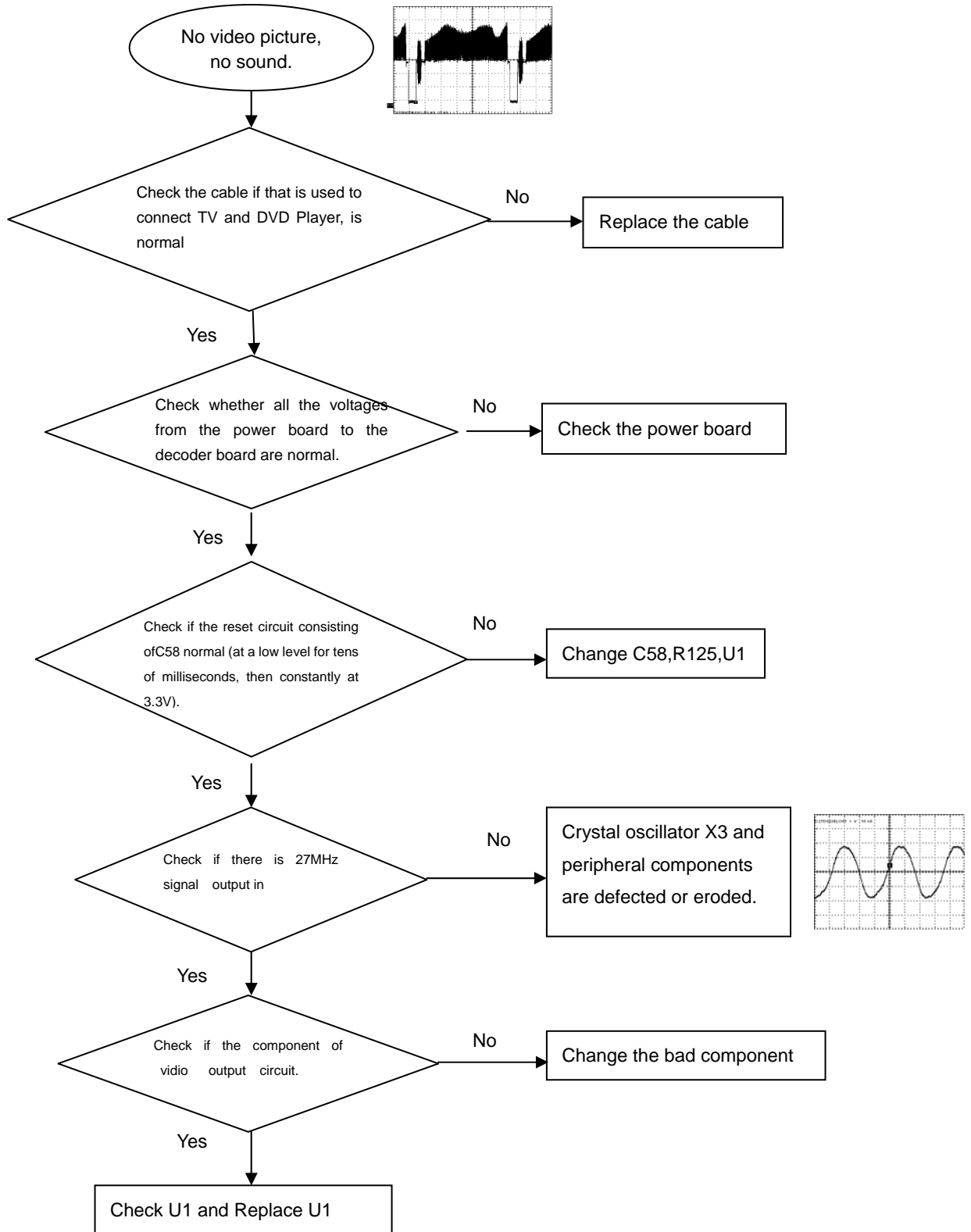

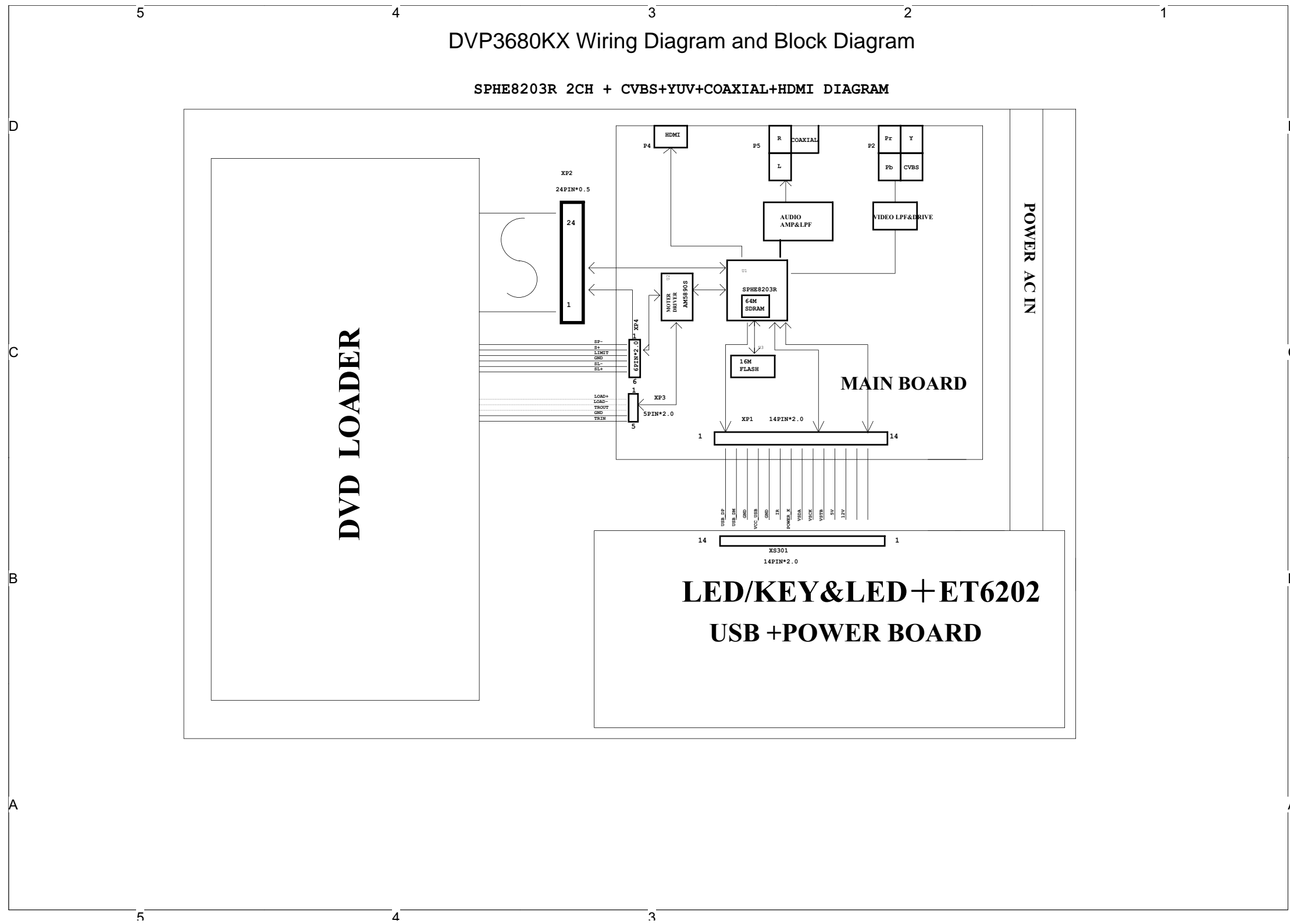

Front+Power+USB+KOK Board Circuit Diagram:

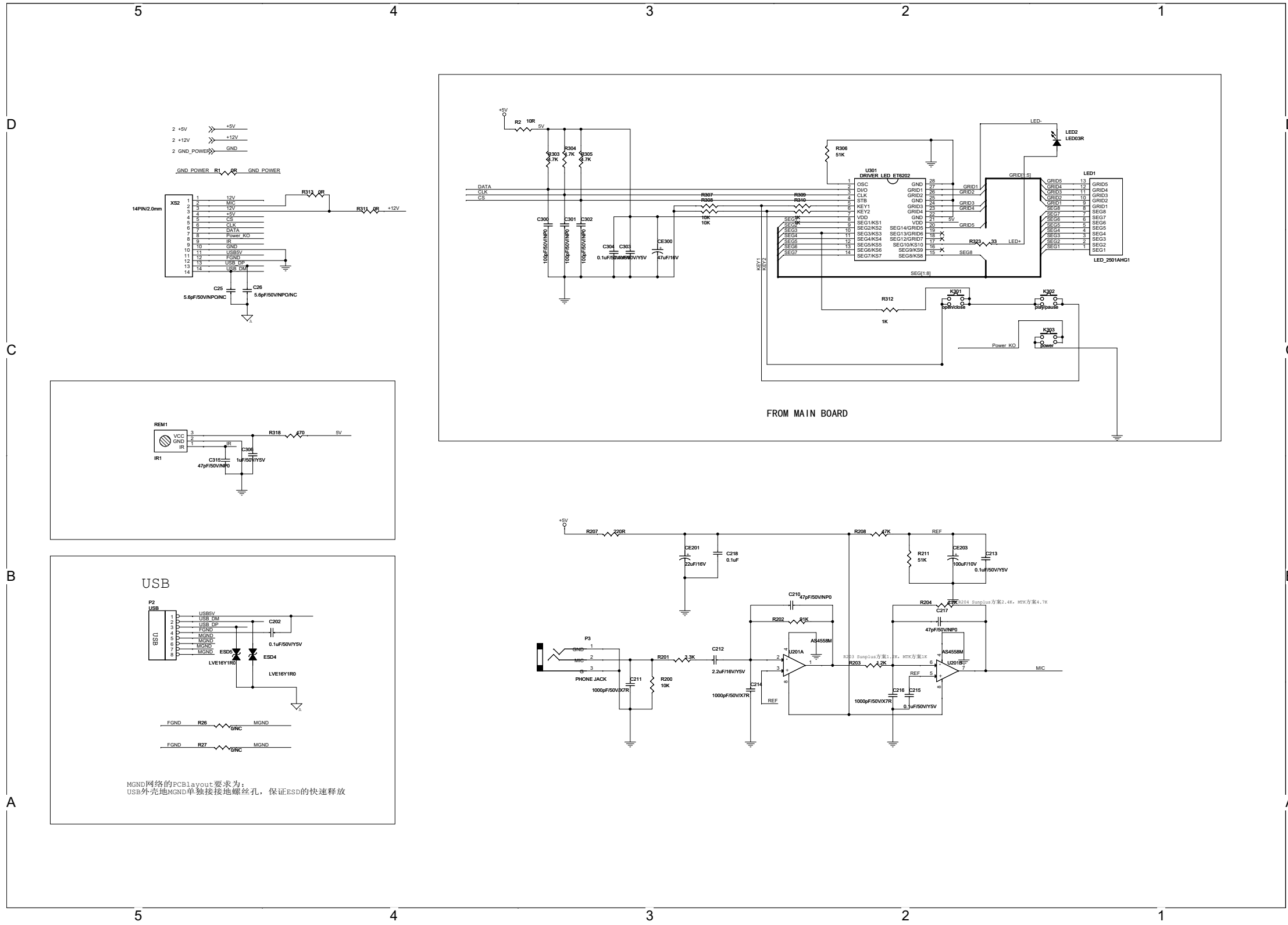

Power Board Circuit Diagram:

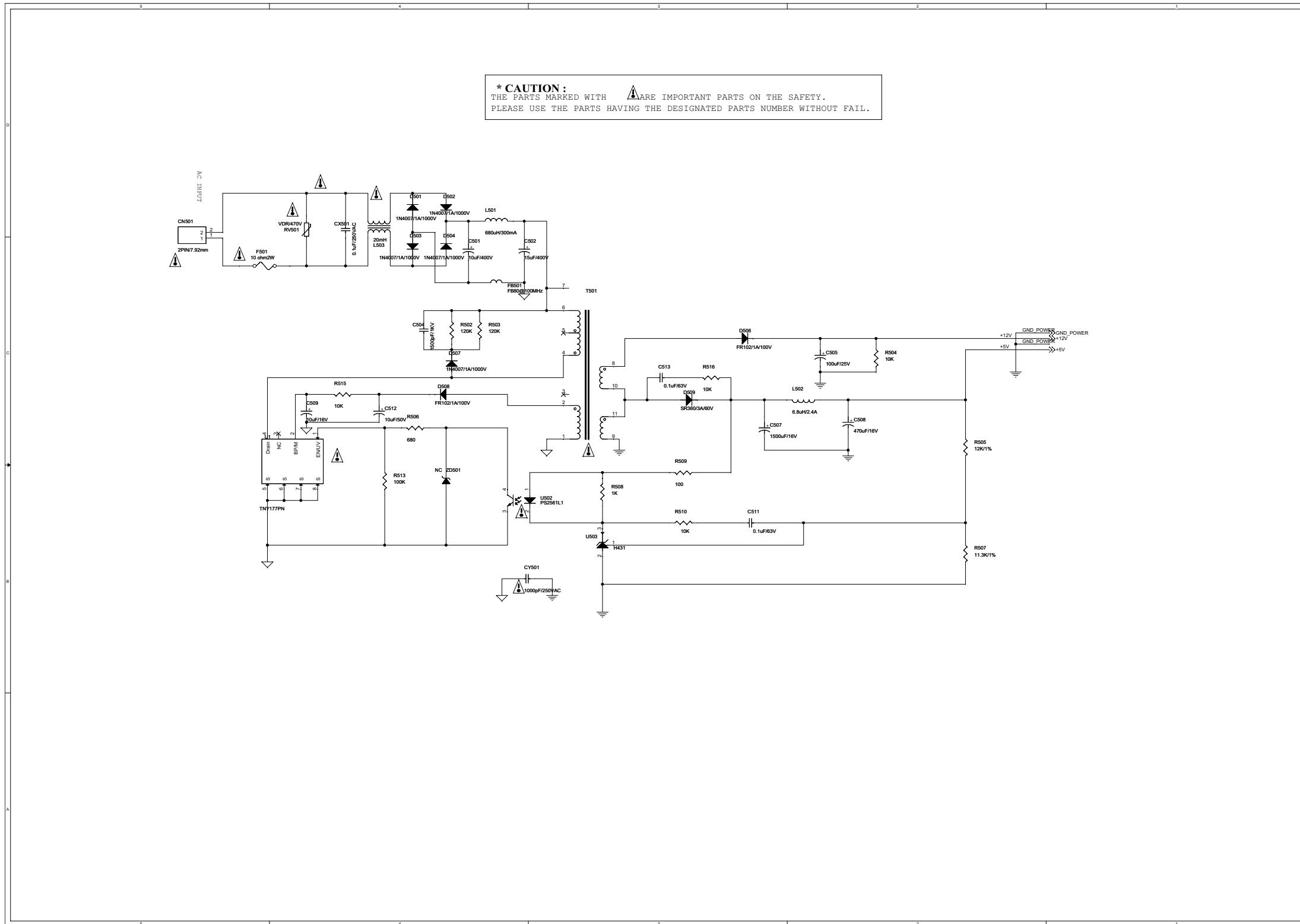

Main Board Circuit Diagram:power source

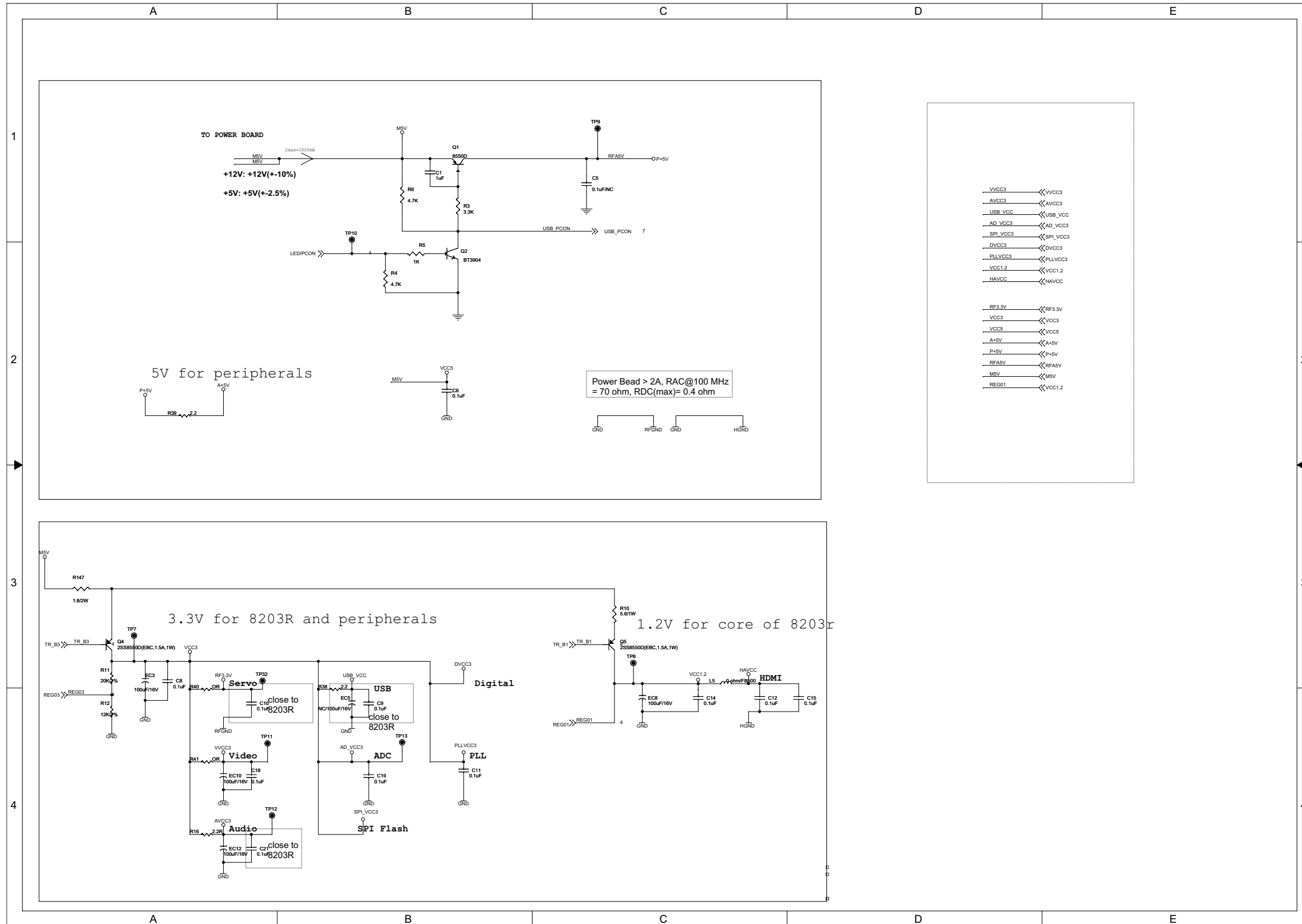

Main Board Circuit Diagram: SPHE8203R

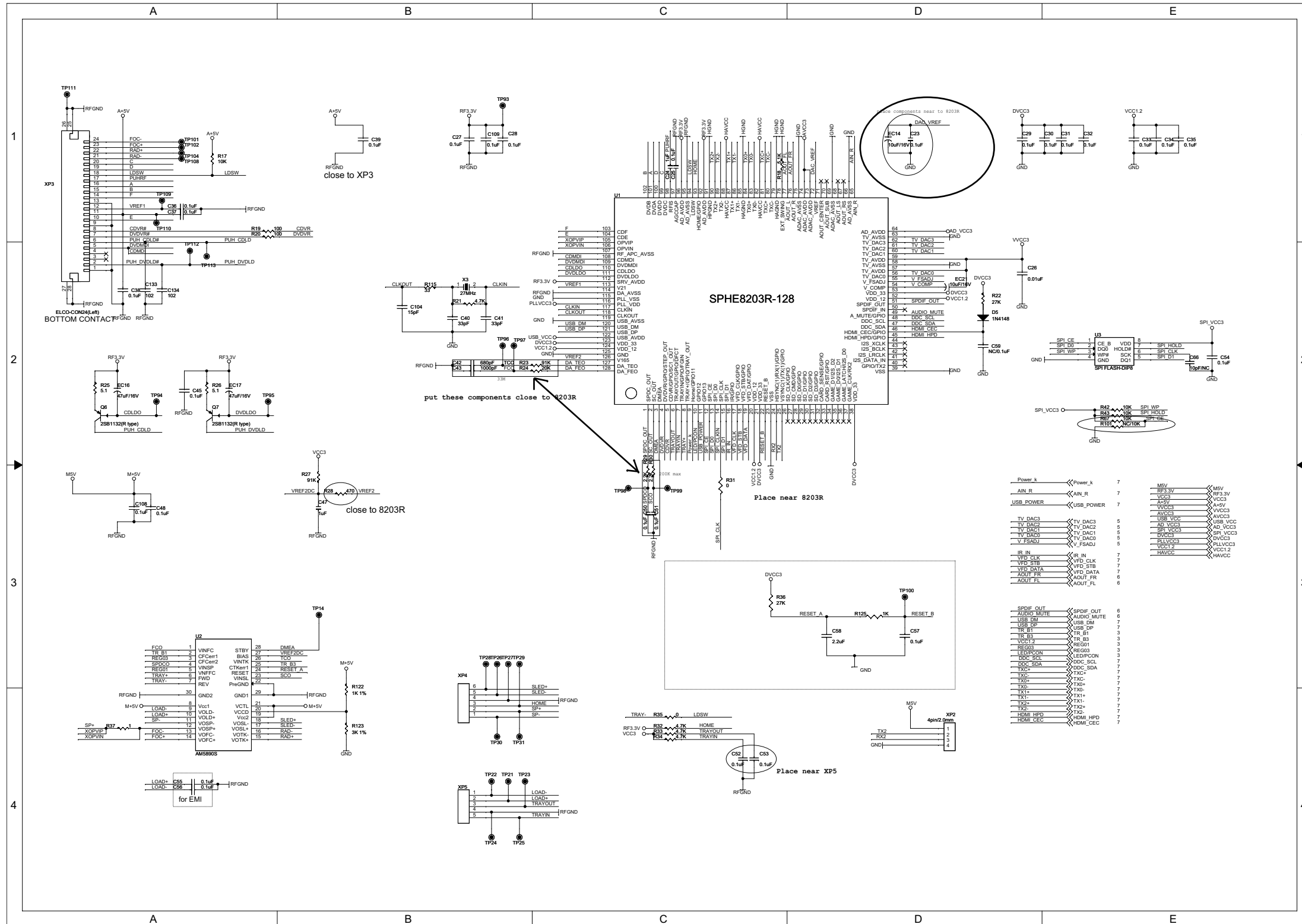

Main Board Circuit Diagram:Video

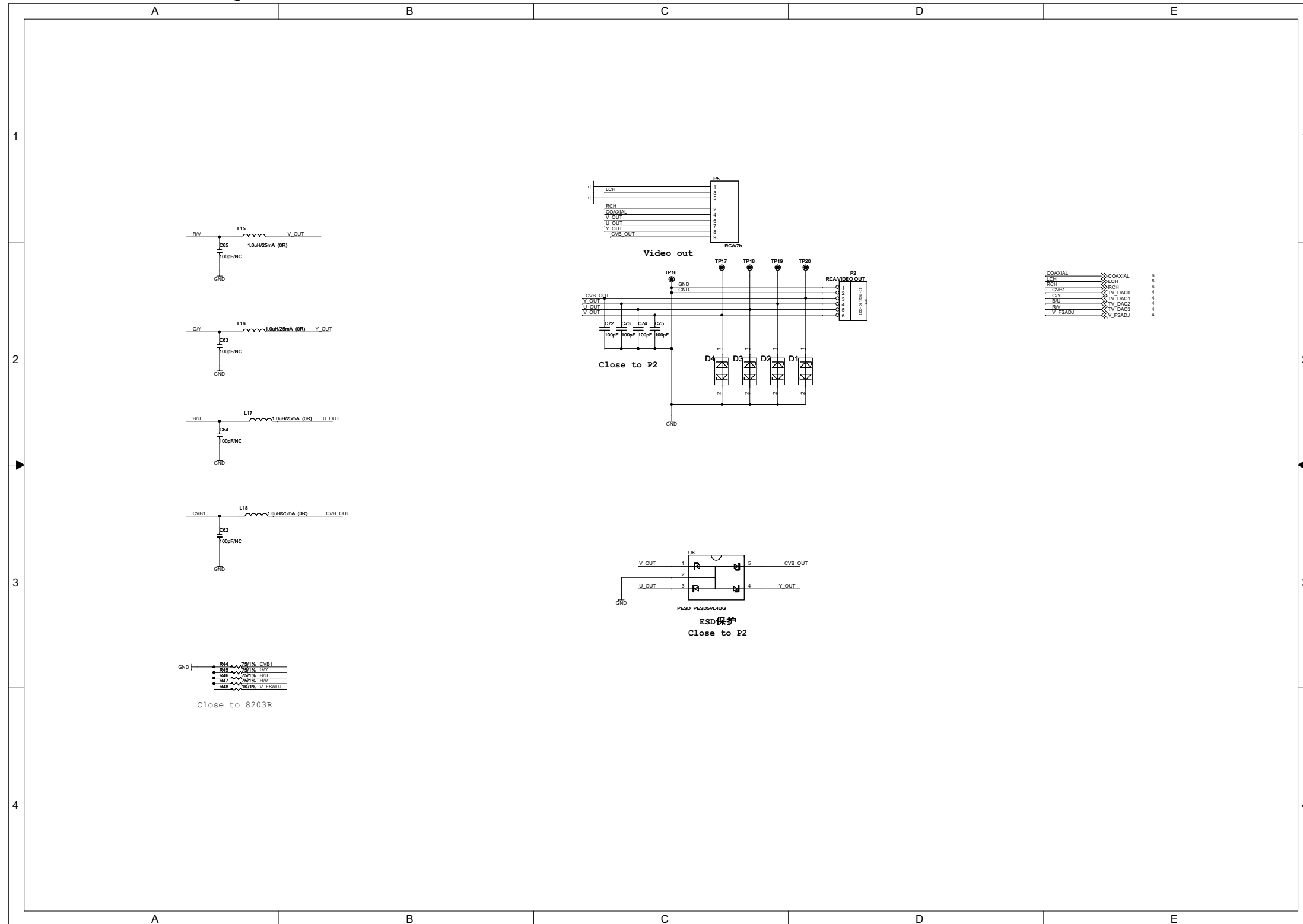

Main Board Circuit Diagram:Audio

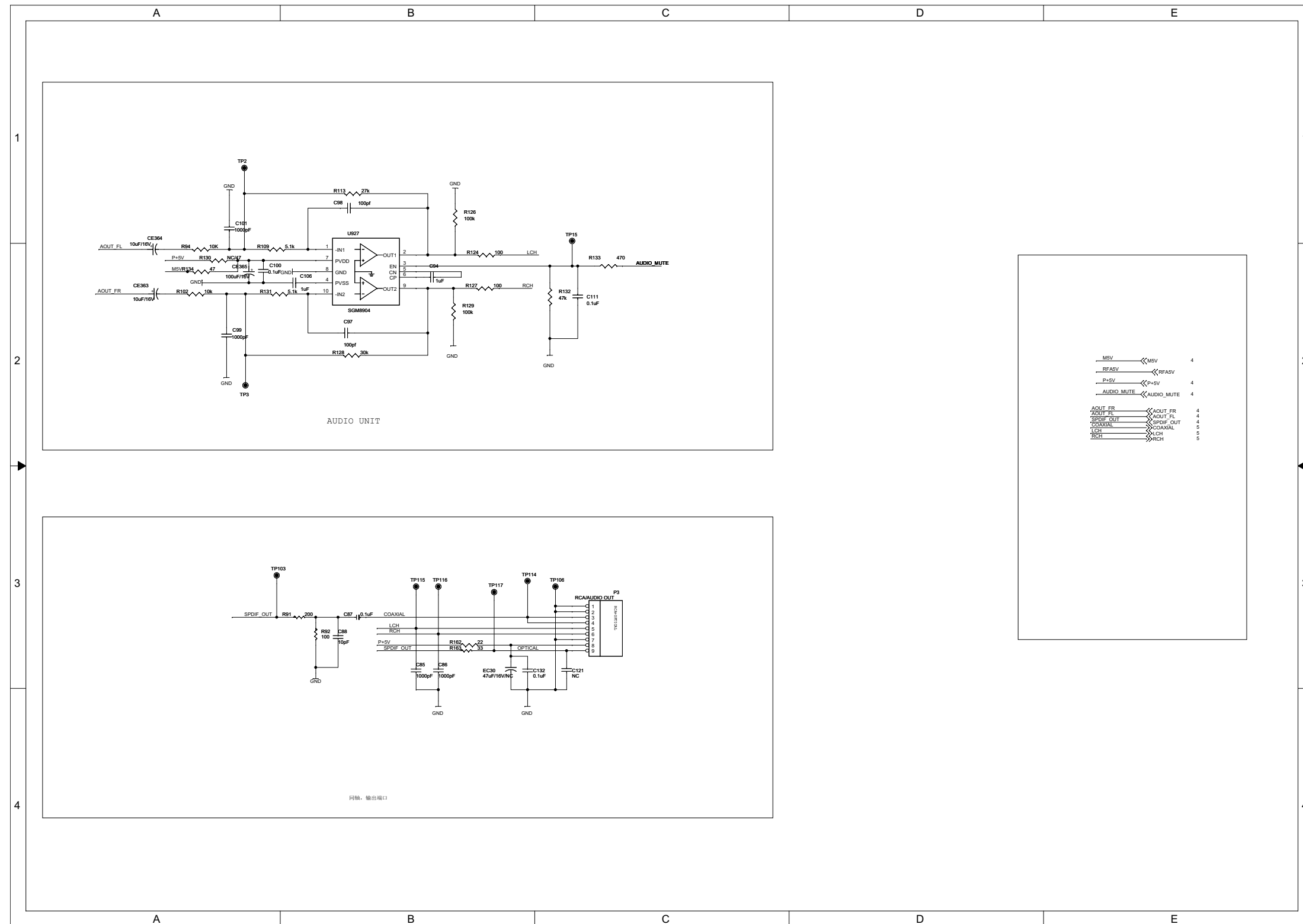

Main Board Circuit Diagram:HDMI&USB

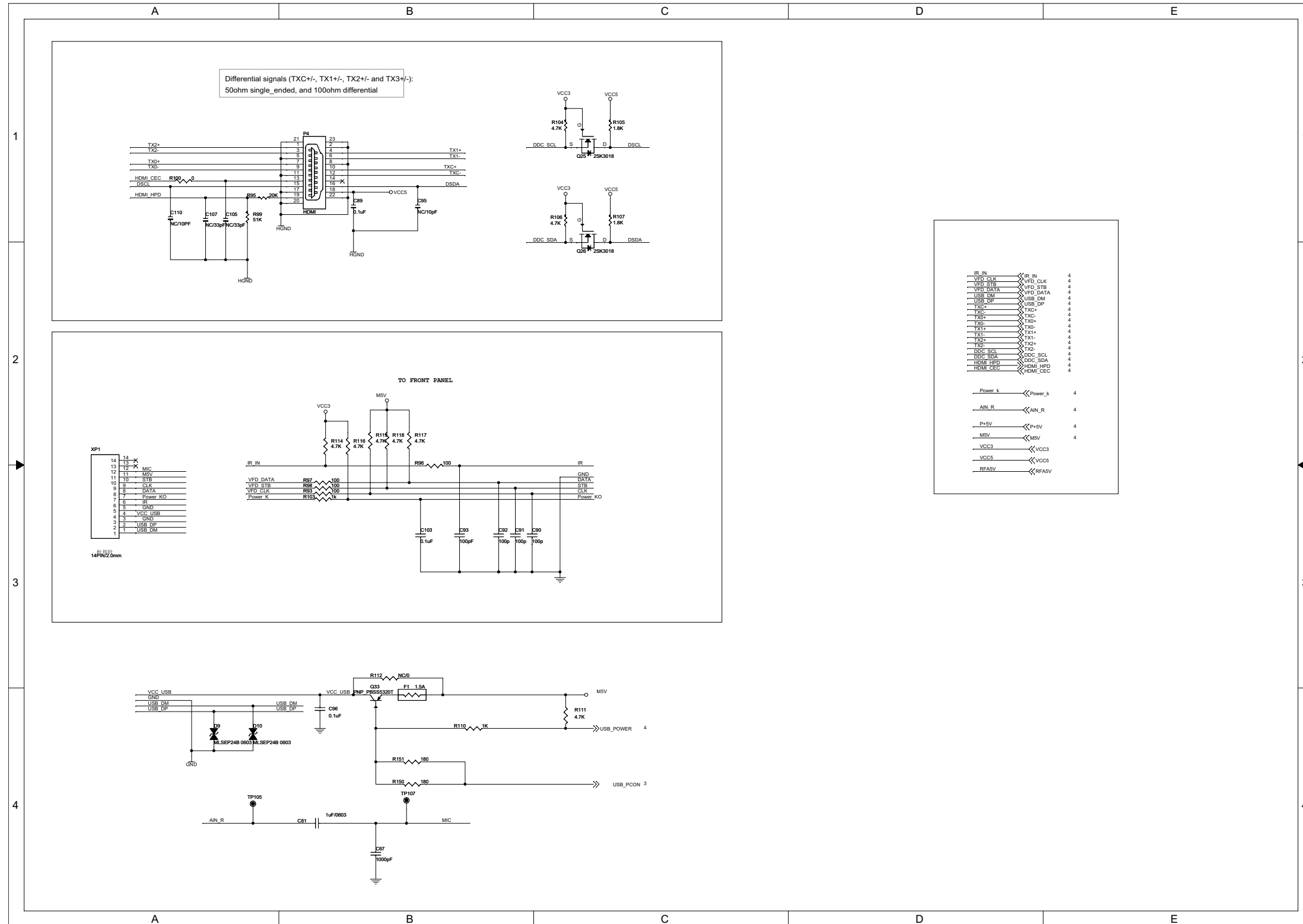

Front+Power+USB+KOK Board Print-layout(top side):

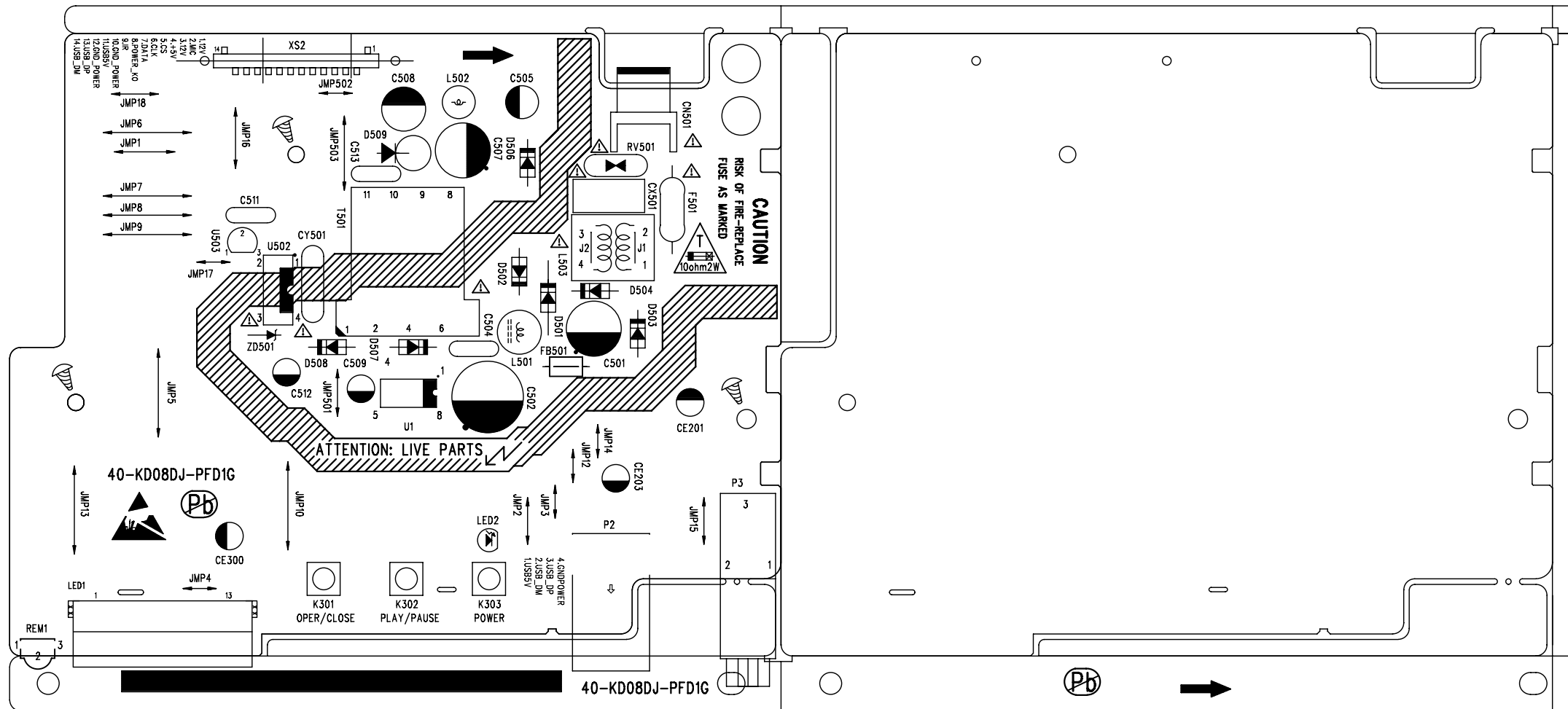

Front+Power+USB+KOK Board Print-layout(bottom side):

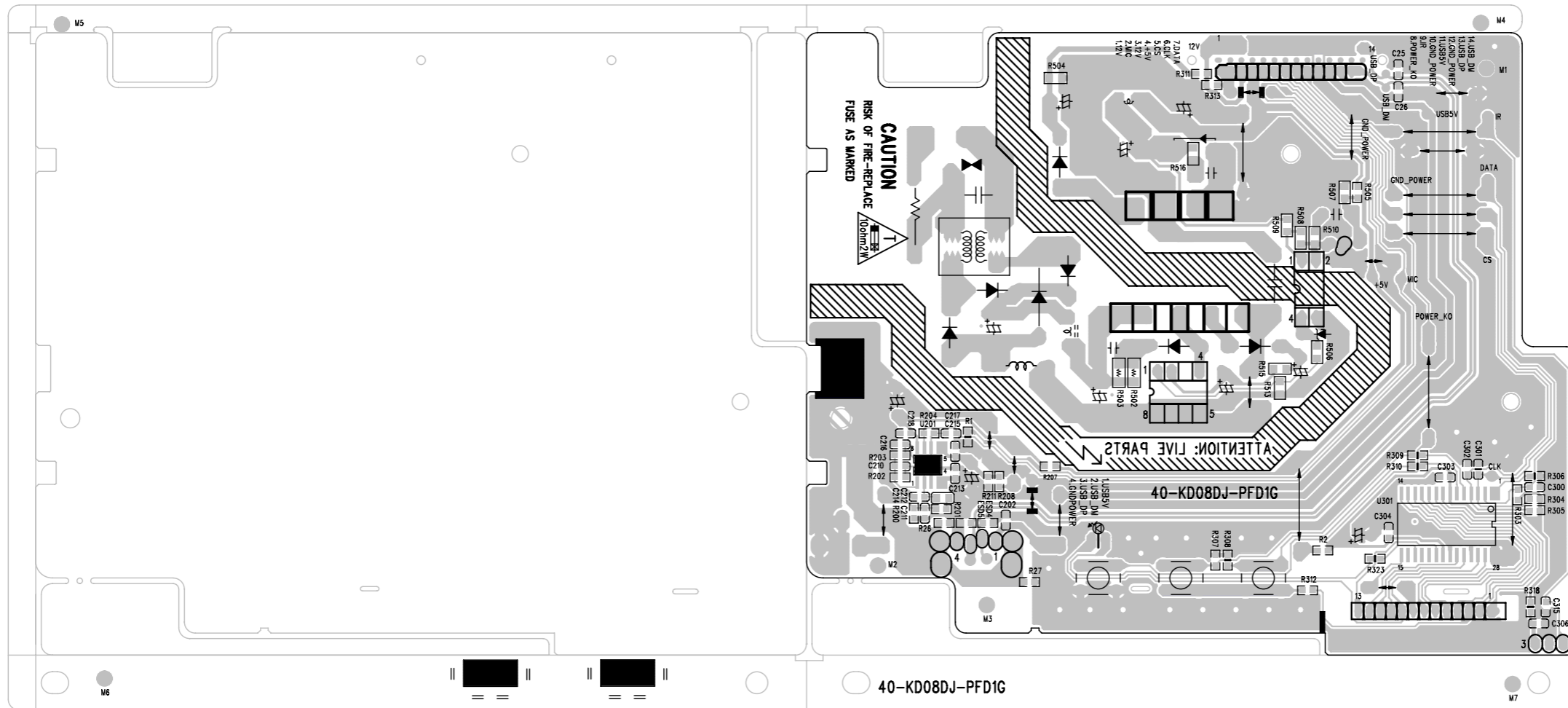

Main Board Print-layout(top side):

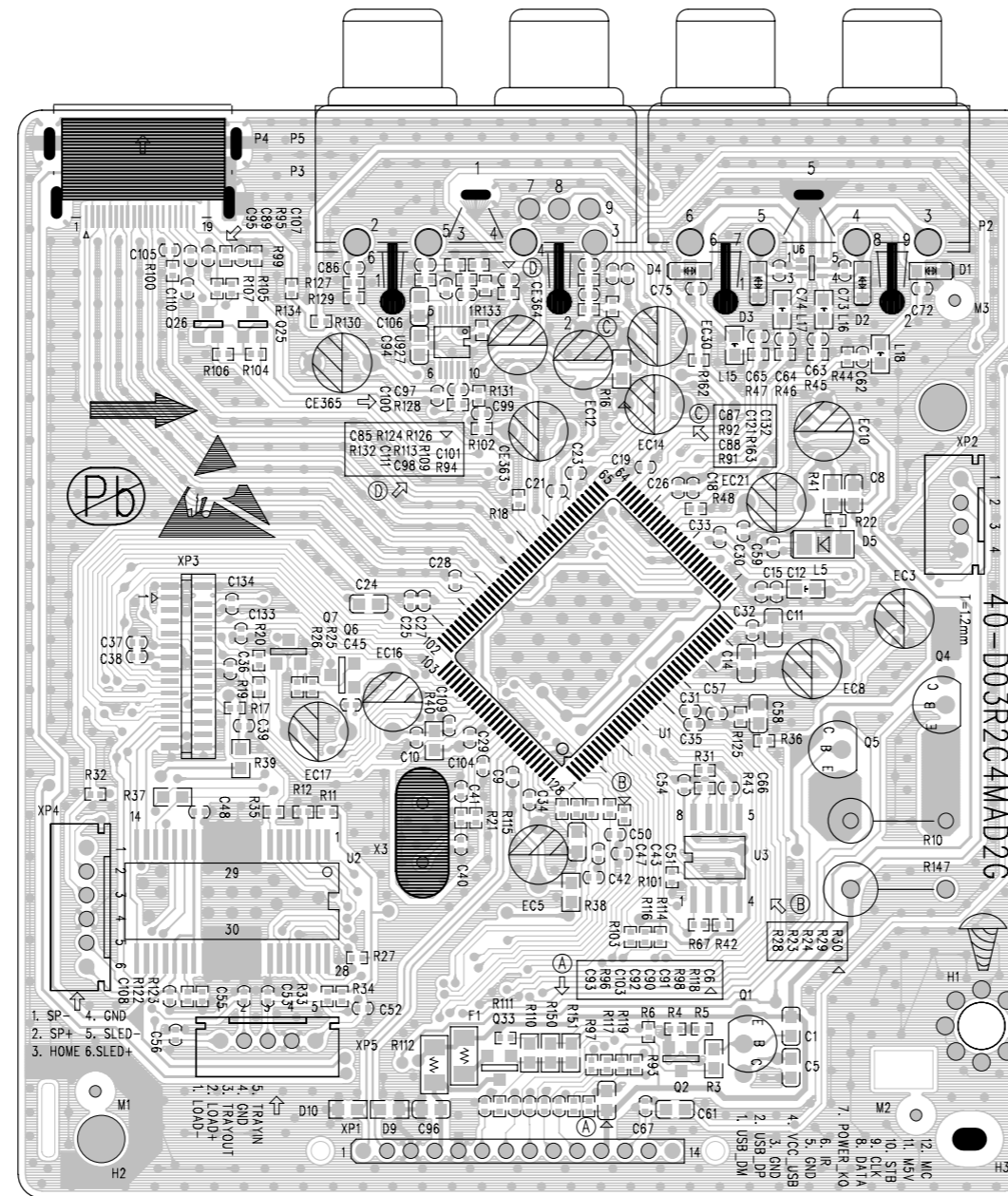

Main Board Print-layout(bottom side):

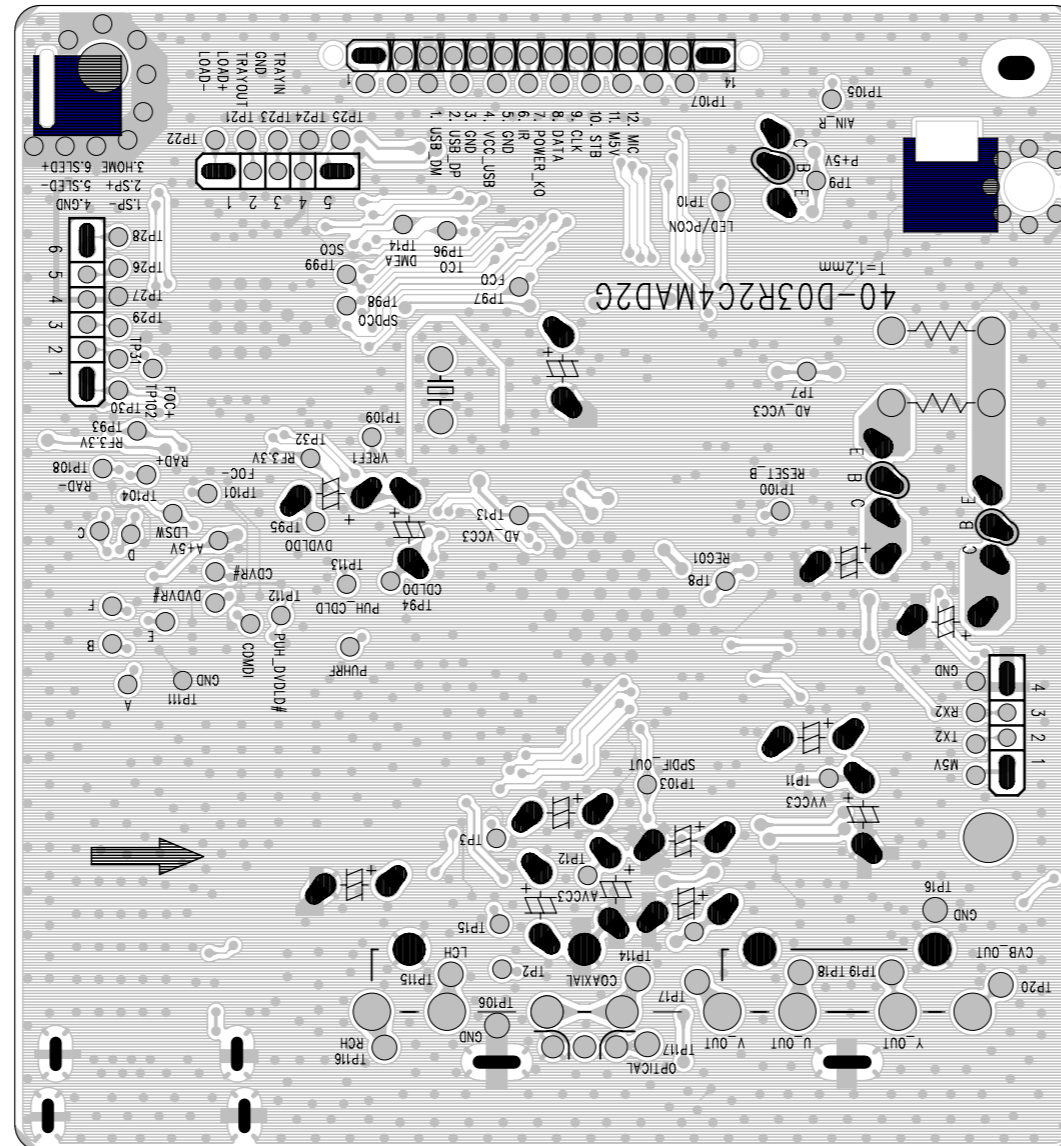

Exploded View for DVP3680KX/77/78:

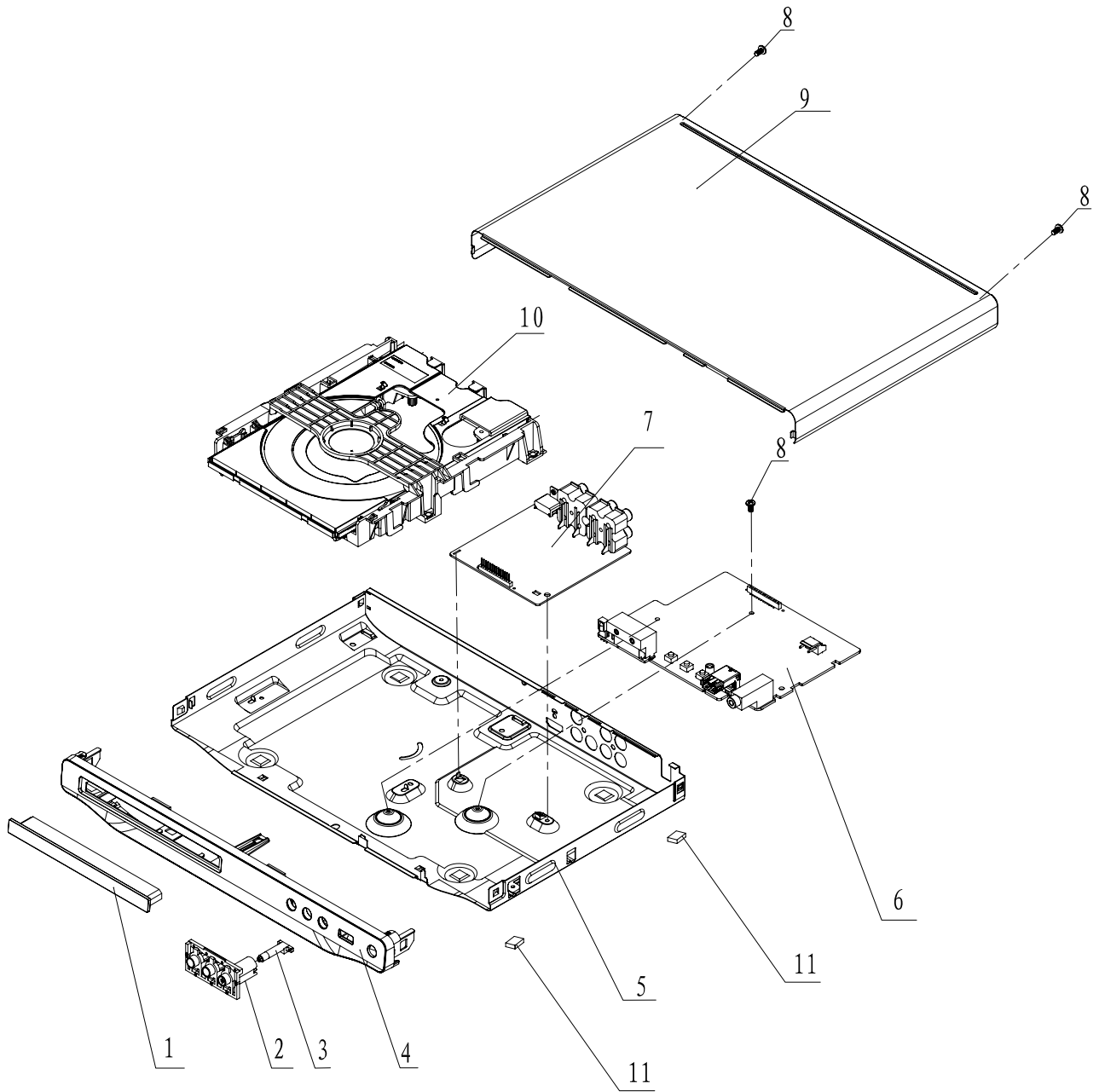

Revision List

Version 1.0

* Initial Release for DVP3680KX/77/78