

CDBZ5T30100-HF

Reverse Voltage: 100 Volts

Forward Current: 30 Amp

RoHS Device

Halogen free

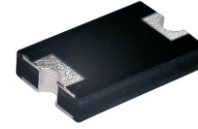

Features

- Lead less chip form, no lead damage.
- Low power loss, High efficiency.
- High current capability, low VF.
- Plastic package has Underwriters Laboratory Flammability Classification 94V-0 .

Mechanical data

- Case: Packed with FRP substrate and epoxy underfilled.
- Terminals: Pure Tin plated (Lead-Free), solderable per MIL-STD-750, method 2026.
- Weight: 0.14 grams (approx).

Circuit Diagram

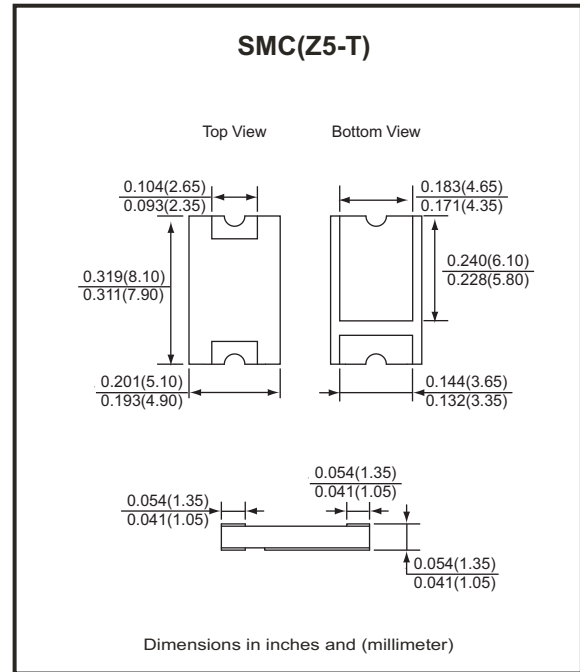

Maximum Ratings (at TA=25°C unless otherwise noted)

Parameter	Symbol	Rating	Unit
Repetitive peak reverse voltage	VRRM	100	V
Average forward current	IF(AV)	30	A
Peak forward surge current (8.3ms single half sine-wave)	IFSM	350	A
Operating and storage temperature range	TJ, TSTG	-55 to +150	°C

Electrical Characteristics (at TA=25°C unless otherwise noted)

Parameter	Symbol	Conditions	Min.	Typ.	Max.	Unit
Forward voltage (NOTE 1)	VF	@ IF = 20 A @ IF = 30 A	-	0.76 0.82	0.80 0.85	V
Repetitive peak reverse current	IRRM	@ VR = Max. VRRM, TA= 25°C	-	3	50	uA
Thermal resistance	RθJA	Junction to ambient (NOTE)	-	78	-	°C/W
	RθJC	Junction to case (NOTE)	-	13	-	°C/W

NOTES : (1) Pulse test width PW=300usec , 1% duty cycle.
(2) Mounted on P.C.B. with 5.0 x 5.0mm copper pad areas.

Company reserves the right to improve product design , functions and reliability without notice.

REV:B

RATING AND CHARACTERISTIC CURVES (CDBZ5T30100-HF)

Fig.1- Forward Current Derating Curve

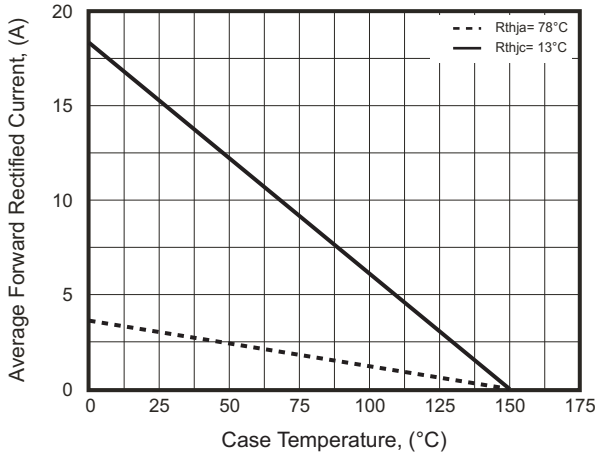

Fig.2- Maximum Non-Repetitive Peak Forward Surge Current

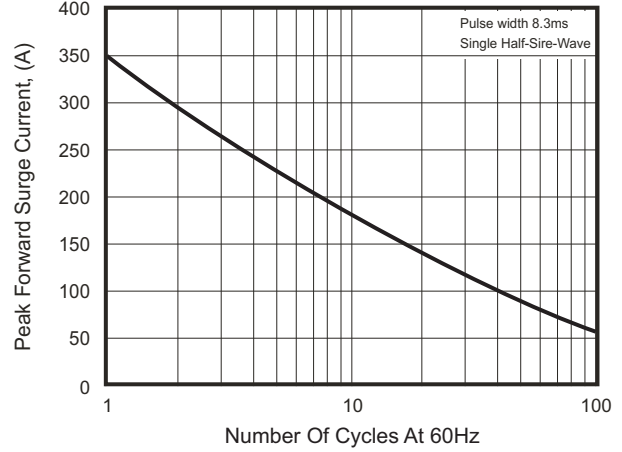

Fig.3- Typical Instantaneous Forward Characteristics

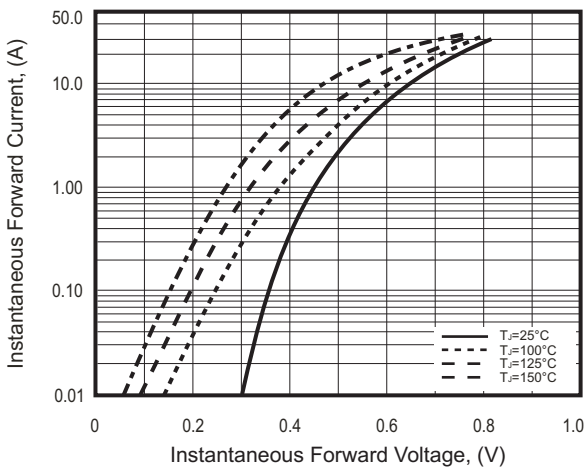
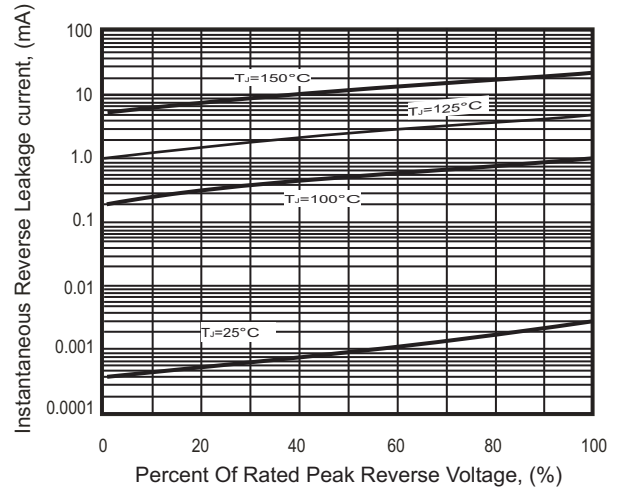
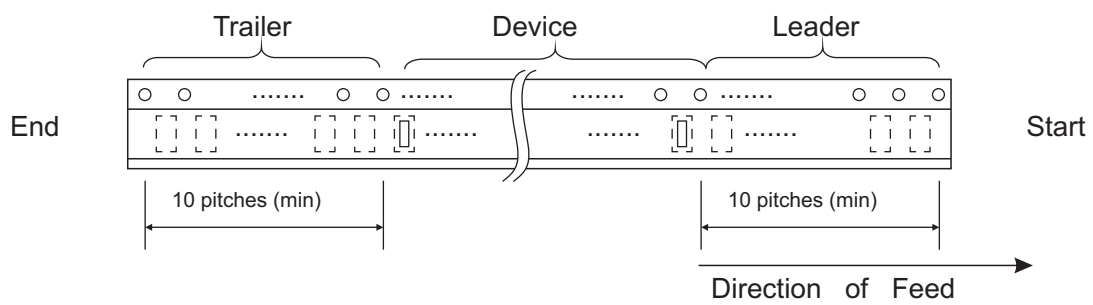
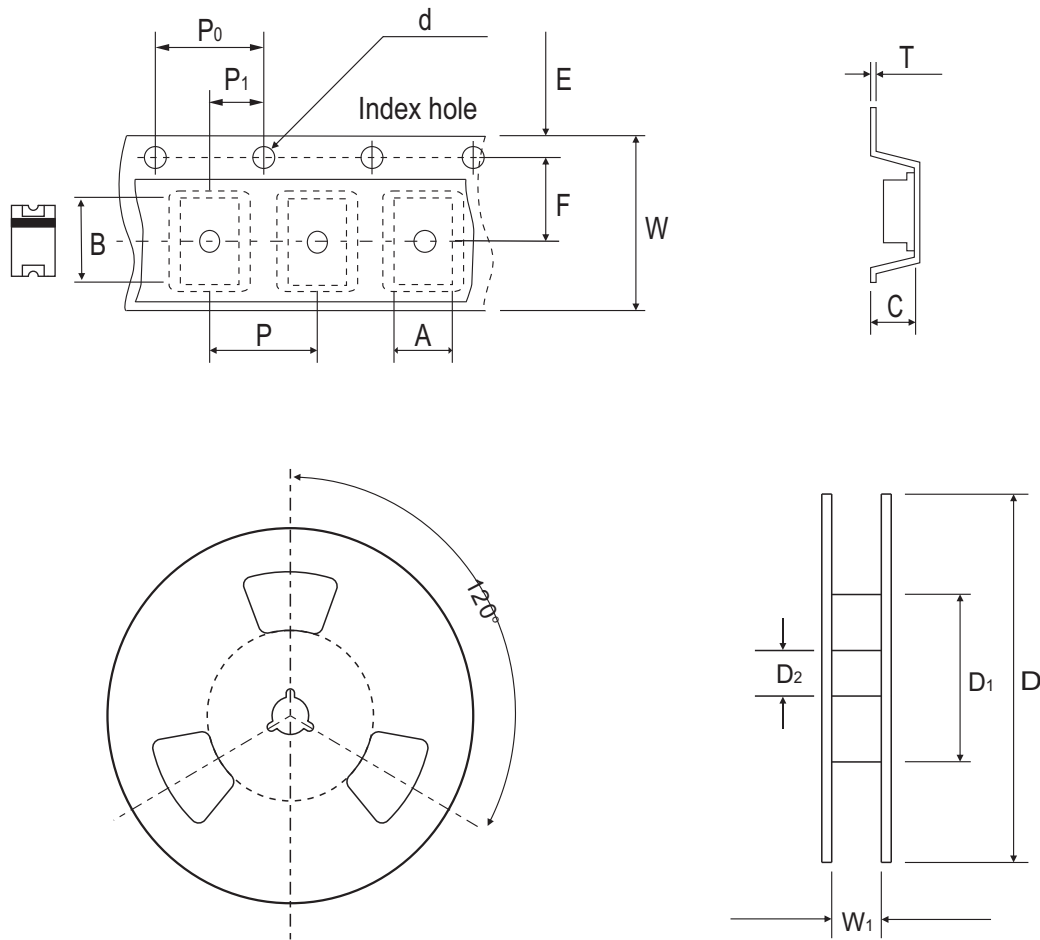

Fig.4- Typical Reverse Characteristics



Company reserves the right to improve product design, functions and reliability without notice.

Reel Taping Specification



SMC(Z5-T)	SYMBOL	A	B	C	d	D	D ₁	D ₂
	(mm)	5.15 ± 0.10	8.15 ± 0.10	1.45 ± 0.10	1.55 ± 0.05	330 ± 2.00	50.0 MIN.	13.0 ± 0.50
	(inch)	0.203 ± 0.004	0.321 ± 0.004	0.057 ± 0.004	0.061 ± 0.002	12.992 ± 0.079	1.969 MIN.	0.512 ± 0.020

SMC(Z5-T)	SYMBOL	E	F	P	P ₀	P ₁	W	W ₁
	(mm)	1.75 ± 0.10	7.50 ± 0.10	8.00 ± 0.10	4.00 ± 0.10	2.00 ± 0.10	16.00 ± 0.30	18.40 MAX.
	(inch)	0.069 ± 0.004	0.295 ± 0.004	0.315 ± 0.004	0.157 ± 0.004	0.079 ± 0.004	0.630 ± 0.012	0.724 MAX.

Company reserves the right to improve product design, functions and reliability without notice.

Marking Code



Suggested PAD Layout

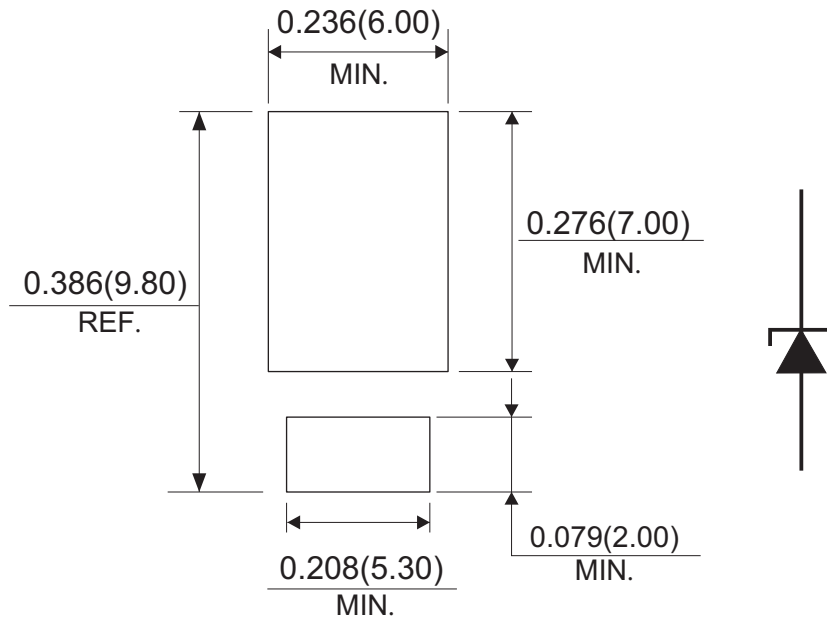

Standard Packaging

Case Type	REEL PACK	
	REEL (pcs)	Reel Size (inch)
SMC(Z5-T)	3,000	13