



EUP2627

620kHz/1.25MHz Step-up DC/DC Converter

DESCRIPTION

The EUP2627 is a high performance current mode, PWM step-up converter with pin selectable operating frequency. With an internal 3.5A, 160mΩ MOSFET, it can generate 12V at up to 500mA output current from a 5V supply. The selectable 620kHz and 1.25MHz allows smaller inductors and faster transient response. An external compensation pin gives the user greater flexibility in setting loop compensation allowing the use of low ESR Ceramic output capacitors. Soft-start is controlled with an external capacitor, which determines the input current ramp rate during start-up.

When shut down, it draws <math>< 10\mu\text{A}</math> of current and can operate down to 2.5V input supply. These features along with 1.25MHz switching frequency makes it an ideal device for portable equipment and TFT-LCD displays.

The EUP2627 is available in an 10-pin TDFN and MSOP-8 (EP) packages. The device is specified for operation over the full -40°C to +85°C temperature range.

FEATURES

- 90% Efficiency
- 3.5A, 160mΩ Power MOSFET
- 2.5V to 5.5V Input Range
- Adjustable Output Voltage up to 28V
- 620kHz/1.25MHz Switching Frequency Selection
- Adjustable Soft-Start
- Internal Thermal Protection
- Small TDFN-10 and MSOP-8 (EP) Packages
- RoHS Compliant and 100% Lead (Pb)-Free Halogen-Free

APPLICATIONS

- TFT-LCD Displays
- DSL Modems
- Set-Top Boxes
- PCMCIA Cards
- Portable Equipment
- Handheld Devices

Typical Application Circuit

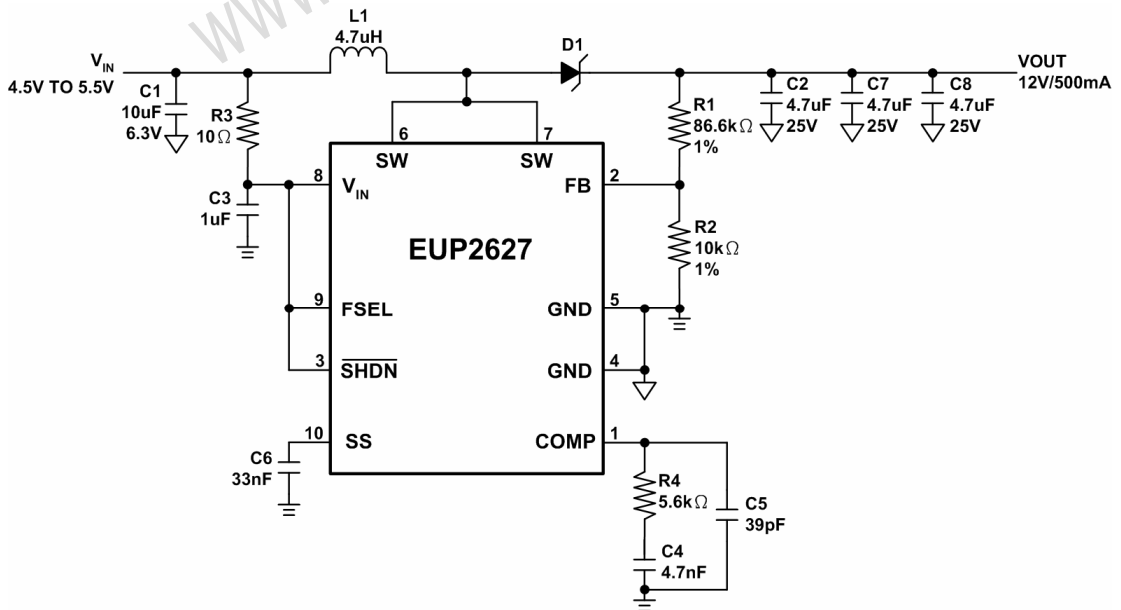

Figure 1.



Typical Application Circuit (continued)

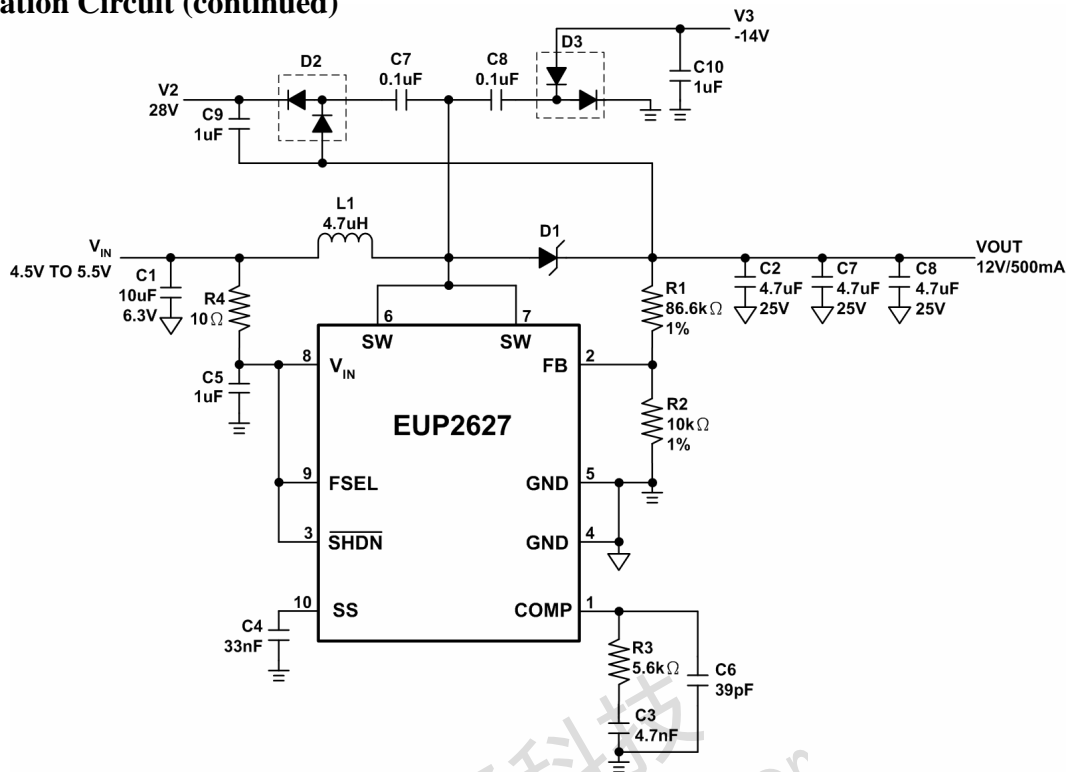

Figure 2. Multiple-Output TFT LCD Power Supply

Pin Configurations

Package Type	Pin Configurations	Package Type	Pin Configurations
TDFN-10	<p>(TOP VIEW)</p>	MSOP-8 (EP)	<p>(TOP VIEW)</p>

Pin Description

PIN	TDFN-10	MSOP-8 (EP)	DESCRIPTION
COMP	1	1	Compensation pin. Output of the internal error amplifier. Capacitor and resistor from COMP pin to ground.
FB	2	2	Voltage feedback pin. Internal reference is 1.24V NOMINAL. Connect a resistor divider from V _{OUT} . $V_{OUT}=1.24V (1+R_1/R_2)$.
SHDN	3	3	Shutdown control pin. Pull SHDN low to turn off the device.
GND	4.5	4	Analog and power ground.
SW	6.7	5	Power switch pin. Switch connected to the drain of the internal power MOSFET.
V _{IN}	8	6	Analog power input pin.
FSEL	9	7	Frequency select pin. When FSEL is connected to GND, switching frequency is set to 620kHz. When connected to V _{IN} , switching frequency is set to 1.25MHz
SS	10	8	Soft-start control pin. Connect a capacitor to control the converter start-up

Absolute Maximum Ratings

■	V _{IN}	6V
■	SW Voltages	30V
■	FB Voltage	6V
■	SHDN Voltage	6V
■	Junction Temperature	150°C
■	Lead Temp (Soldering, 10sec)	300°C
■	Thermal Resistance	
	θ _{JA} (MSOP-8_EP)	70°C/W
	θ _{JA} (TDFN-10)	69°C/W
■	ESD Ratings	
	Human Body Model	2kV

Operating Conditions

■	Operating Temperature	-40°C to +85°C
■	Supply Voltage	2.5V to 5.5V
■	SW Voltage Max	28V

Electrical Characteristics

V_{IN}=V_{SHDN}=3V. T_A=-40°C to +85°C. Typical values are at T_A=+25°C. Unless otherwise noted.

Symbol	Parameter	Conditions	EUP2627			Unit
			Min.	Typ.	Max.	
V _{IN}	Input Voltage Range	V _{OUT} <18V	2.5		5.5	V
		18V< V _{OUT} <24V	4.0		5.5	
UVLO	VIN Undercoltage Lockout	SW Remains off below this level. V _{IN} Rising, 20mV hysteresis	1.92	2.15	2.35	V
I _Q	Quiescent Current	FB=2V (Not Switching)		0.5	0.8	mA
		FB=0V (Switching)		1.5	2	mA
		V _{SHDN} =0V		0.1	10	µA
V _{FB}	FB Regulation Voltage		1.20	1.24	1.27	V
I _B	FB Input Bias Current	V _{FB} =1.24V		100	250	nA
%V _{FB} /	FB Line Regulation	2.5V ≤ V _{IN} ≤ 5.5V		0.08	0.15	%/V
%V _{FB} /	FB Load Regulation	V _{OUT} =8V, I _{load} =30mA to 200 mA		6.7		mV/A
gm	Error Amp Transconductance	△I=4µA	20	45	95	µmho
A _V	Error Amp Voltage Gain			500		V/V
Fs	Switching Frequency	FSLCT=Ground	500	620	740	kHz
		FSLCT=V _{IN}	900	1250	1500	kHz
D _{MAX}	Maximum Duty Cycle			94		%
I _{CL}	Switch Current Limit	55% Duty Cycle	2.6	3.5		A
R _{DSON}	Switch MOSFET On Resistance	I _{SW} =500mA		0.16	0.35	Ω
I _L	Switch Leakage Current	V _{SW} =20V		0.2	20	µA
I _{SS}	Charge Current	V _{SS} =0V	3	5	8	µA
V _{IL}	SHDN, FREQ Input Low Voltage				0.5	V
V _{IH}	SHDN, FREQ Input High Voltage		2			V
I _{FSLCT}	FSLCT Pull Down Current		2.4	5.5	8.2	µA

Typical Operating Characteristics

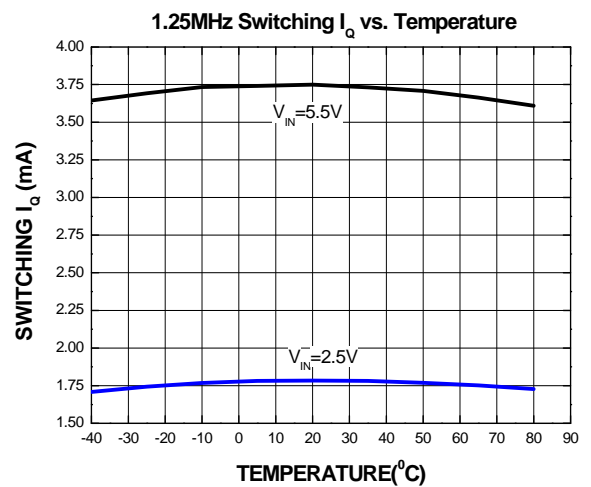
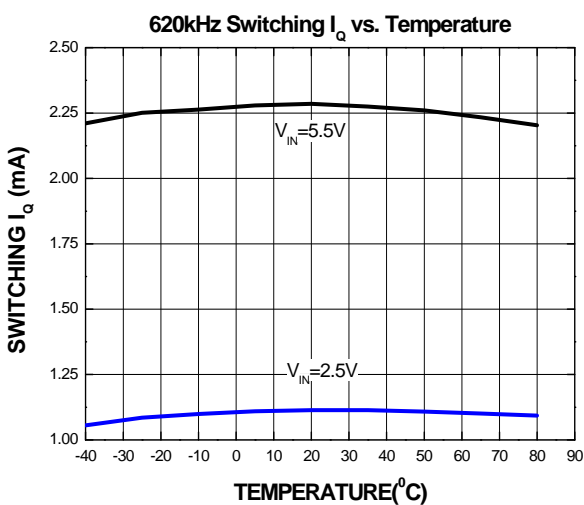
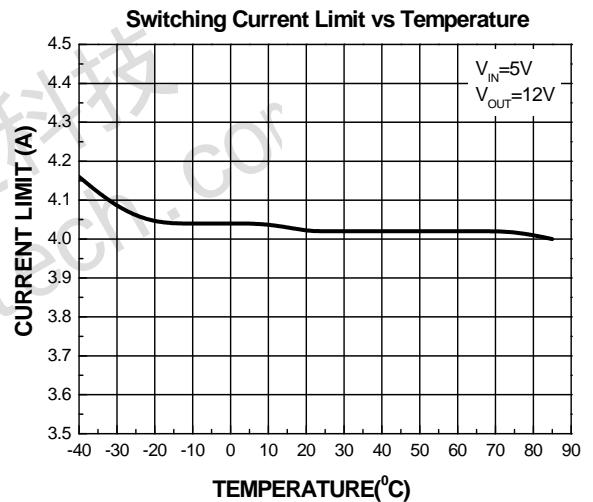
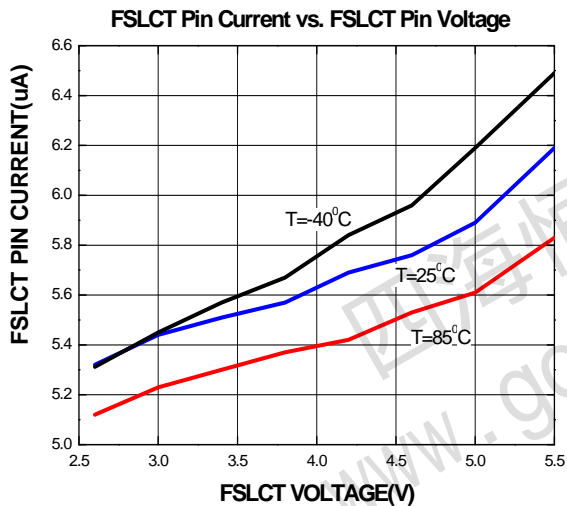
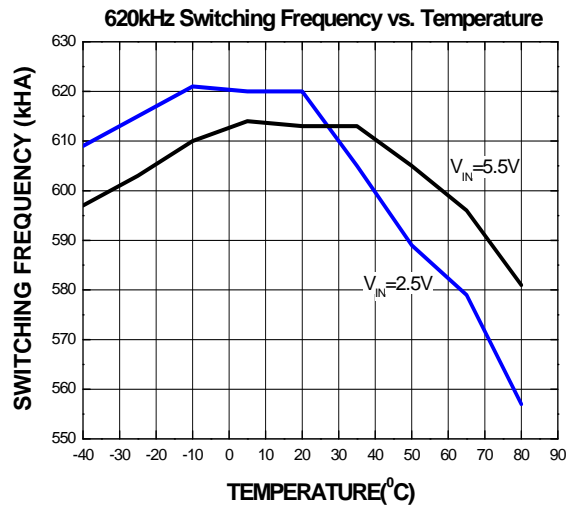
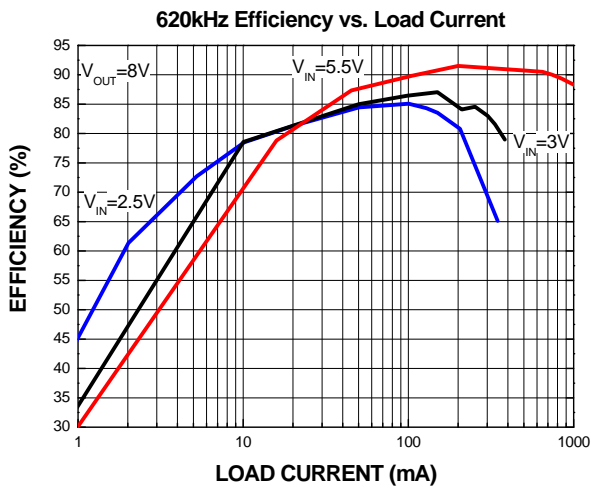

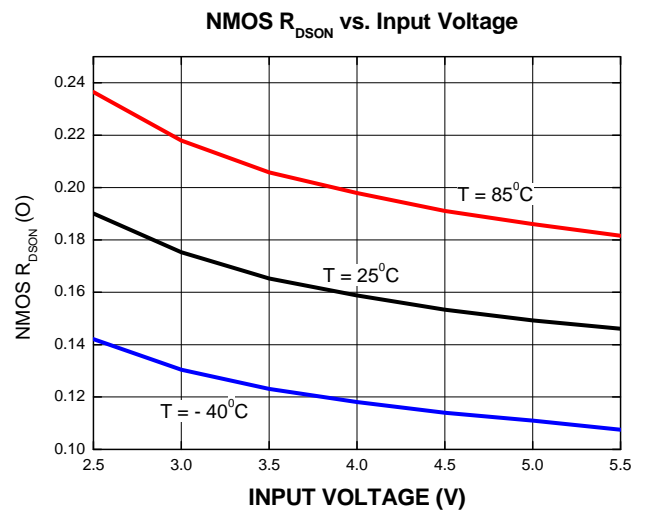
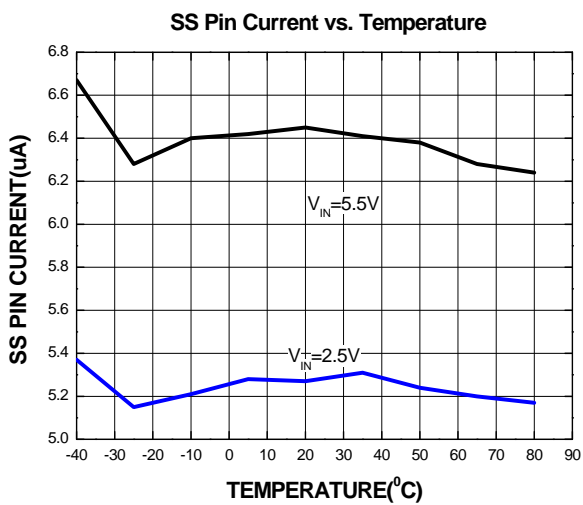
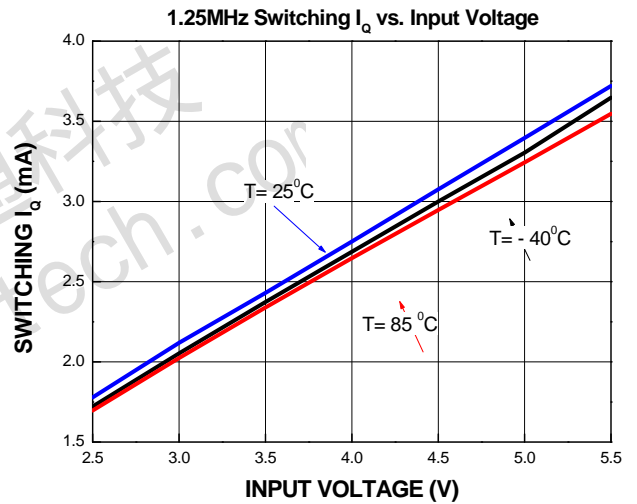
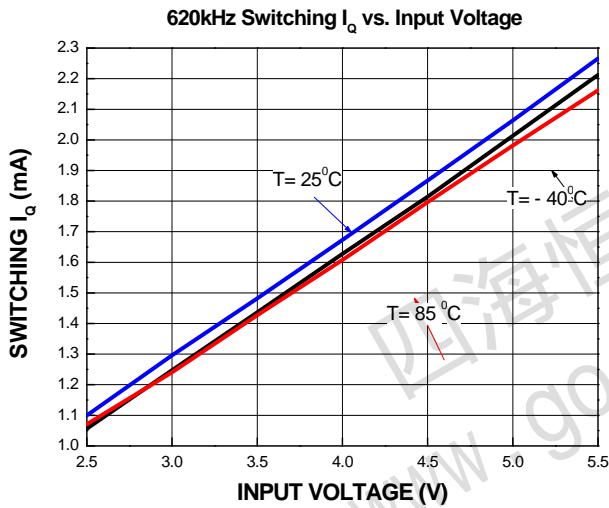
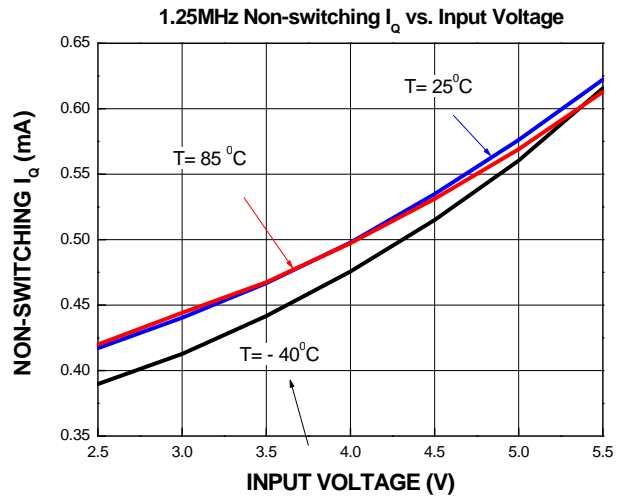
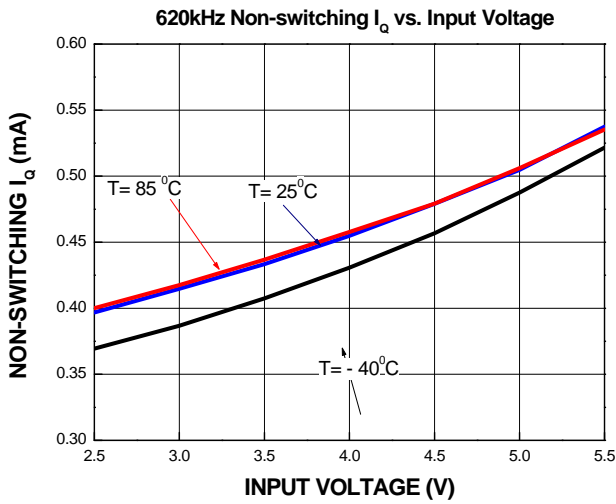

Application Information

Boost Converter Operations

In steady state operating and continuous conduction mode where the inductor current is continuous, the boost converter operates in two cycles. During the first cycle, the internal power FET turns on and the Schottky diode is reverse biased and cuts off the current flow to the output. The output current is supplied from the output capacitor. The voltage across the inductor is V_{IN} and the inductor current ramps up in a rate of V_{IN}/L , L is the inductance. The inductance is magnetized and energy is stored in the inductor. The change in inductor current is:

$$\Delta I_L = \Delta T_2 \times \frac{V_{IN} - V_{OUT}}{L}$$

$$\Delta T_2 = \frac{1 - D}{F_{SW}}$$

For stable operation, the same amount of energy stored in the inductor must be taken out. The change in inductor current during the two cycles must be the same.

$$\Delta I_1 + \Delta I_2 = 0$$

$$\frac{D}{F_{SW}} \times \frac{V_{IN}}{L} + \frac{1 - D}{F_{SW}} \times \frac{V_{IN} - V_{OUT}}{L} = 0$$

$$\frac{V_{OUT}}{V_{IN}} = \frac{1}{1 - D}$$

Output Voltage

An external feedback resistor divider is required to divide the output voltage down to the nominal 1.24V reference voltage. The current drawn by the resistor network should be limited to maintain the overall converter efficiency. The maximum value of the resistor network is limited by the feedback input bias current and the potential for noise being coupled into the feedback pin. Selecting R_2 in the range of 10k Ω to 50 k Ω . The boost converter output voltage is determined by the relationship:

$$V_{OUT} = V_{FB} \times \left[1 + \frac{R_1}{R_2} \right]$$

The nominal VFB voltage is 1.24V

Inductor Selection

The inductor selection determines the output ripple voltage, transient response, output current capability, and efficiency. Its selection depends on the input voltage, output voltage, switching frequency, and maximum output current. For most applications, a 4.7 μ H inductor is recommended for 1.25MHz application and a 10 μ H inductor is recommended for 620kHz application. The inductor maximum DC current specification must be greater than the peak inductor current required by the regulator. The peak inductor current can be calculated:

$$I_{L(PEAK)} = \frac{I_{OUT} \times V_{OUT}}{V_{IN}} + 1/2 \times \frac{V_{IN} \times (V_{OUT} - V_{IN})}{L \times V_{OUT} \times FREQ}$$

Output Capacitor

Low ESR capacitors should be used to minimize the output voltage ripple. Multilayer ceramic capacitors (X5R and X7R) are preferred for the output capacitors because of their lower ESR and small packages. Tantalum capacitors with higher ESR can also be used. The output ripple can be calculated as:

$$\Delta V_O = \frac{I_{OUT} \times D}{F_{SW} \times C_O} + I_{OUT} \times ESR$$

Choose an output capacitor to satisfy the output ripple and load transient requirement. A 10 μ F to 22 μ F ceramic capacitor is suitable for most application.

For noise sensitive application, a 0.1 μ F placed in parallel with the larger output capacitor is recommended to reduce the switching noise coupled from the SW switching node.

Schottky Diode

In selecting the Schottky diode, the reverse break down voltage, forward current and forward voltage drop must be considered for optimum converter performance. The diode must be rated to handle 3.5A, the current limit of the EUP2627. The breakdown voltage must exceed the maximum output voltage. Low forward voltage drop, low leakage current, and fast reverse recovery will help the converter to achieve the maximum efficiency.

Input Capacitor

The value of the input capacitor depends the input and output voltages, the maximum output current, the inductor value and the noise allowed to put back on the input line. For most applications, a minimum 10μF is required. For applications that run close to the maximum output current limit, input capacitor in the range of 22μF to 47μF is recommended. The EUP2627 is powered from the VIN. High frequency 0.1μF by-pass cap is recommended to be close to the VIN pin to reduce supply line noise and ensure stable operation.

Loop Compensation

The EUP2627 incorporates an transconductance amplifier in its feedback path to allow the user some adjustment on the transient response and better regulation. The EUP2627 uses current mode control architecture which has a fast current sense loop and a slow voltage feedback loop. The fast current feedback loop does not require any compensation. The slow voltage loop must be compensated for stable operation. The compensation network is a series RC network from COMP pin to ground. The resistor sets the high frequency integrator gain for fast transient response and the capacitor sets the integrator zero to ensure loop stability. For most applications, the compensation resistor in the range of 2K to 30K and the compensation capacitor in the range of 1nF to 10nF.

Soft-Start

The soft-start is provided by an internal 5μA current source charges the external CSS, the peak MOSFET current is limited by the voltage on the capacitor. This in turn controls the rising rate of the output voltage. The regulator goes through the start-up sequence as well after the SHDN pin is pulled to HI.

Frequency Selection

The EUP2627 switching frequency can be user selected to operate at either at constant 620kHz or 1.25MHz. Connecting FSEL pin to ground sets the PWM switching frequency to 620kHz. When connect FSEL high or VDD, switching frequency is set to 1.25MHz.

Shut-Down Control

The EUP2627 shuts down to reduce the supply current to 0.1μA when SHDN is low. In this mode, the internal reference, error amplifier, comparators, and biasing circuitry turn off while the N-channel MOSFET is turned off. The boost converter's output is connected to IN via the external inductor and catch diode.

Maximum Output Current

The output current capability of the EUP2627 is a function of current limit, input voltage, operating frequency, and inductor value. The output current capability is governed by the following equation:

$$I_L = I_{L - AVG} + \left(1/2 \times \Delta I_L\right)$$

Where:

I_L = MOSET current limit

$I_{L - AVG}$ = average inductor current

ΔI_L = inductor ripple current

$$\Delta I_L = \frac{V_{IN} \times \left[\left(V_O + V_{DIODE} - V_{IN} \right) - V_{IN} \right]}{L \times \left(V_O + V_{DIODE} \right) \times F_S}$$

V_{DIODE} = Schottky diode forward voltage, typically, 0.6V

F_S = switching frequency, 620KHz or 1.25MHz

$$I_{L - AVG} = \frac{I_{OUT}}{1 - D}$$

D = MOSFET turn-on ratio:

$$D = 1 - \frac{V_{IN}}{V_{OUT} + V_{DIODE}}$$

Layout Considerations

Good PC board layout and routing are required in high-frequency switching power supplies to achieve good regulation, high efficiency, and stability. It is strongly recommended that the evaluation kit PC board layouts be followed as closely as possible. Place power components as close together as possible, keeping their traces short, direct, and wide. Avoid interconnecting the ground pins of the power components using vias through an internal ground plane. Instead, keep the power components close together and route them in a "star" ground configuration using component-side coper, then connect the star ground to internal ground using multiple vias.

Packaging Information

TDFN-10

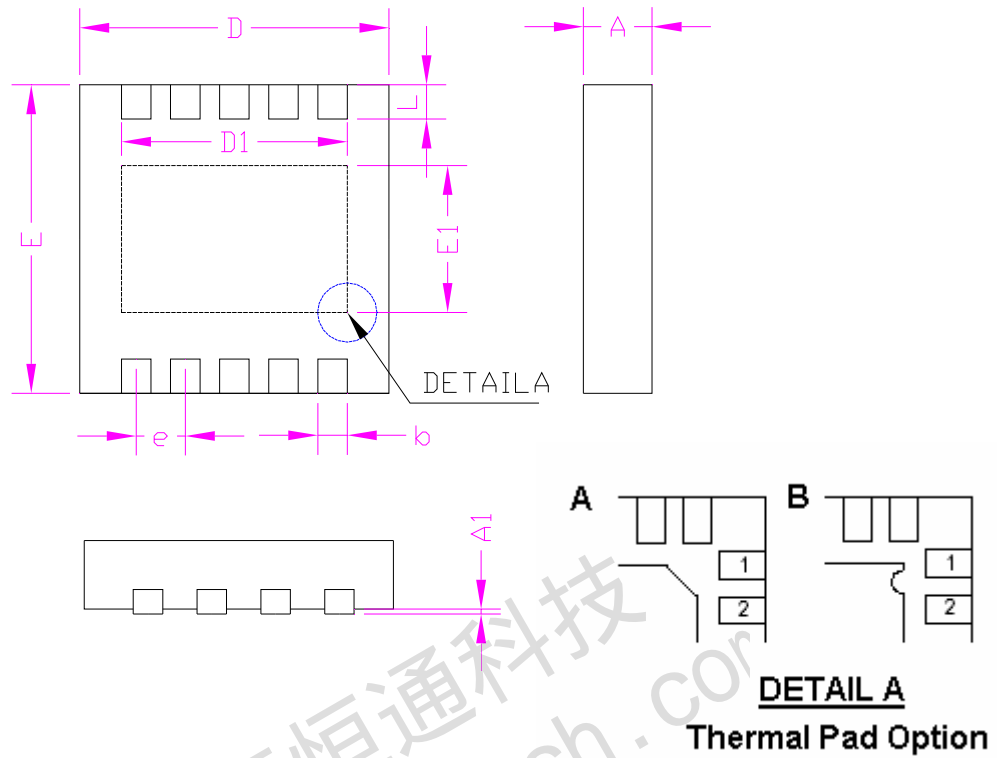

SYMBOLS	MILLIMETERS		INCHES	
	MIN.	MAX.	MIN.	MAX.
A	0.70	0.80	0.028	0.031
A1	0.00	0.05	0.000	0.002
D	2.90	3.10	0.114	0.122
E1	1.70		0.067	
E	2.90	3.10	0.114	0.122
L	0.30	0.50	0.012	0.020
b	0.18	0.30	0.007	0.012
e	0.50		0.020	
D1	2.40		0.094	

MSOP-8 (EP)

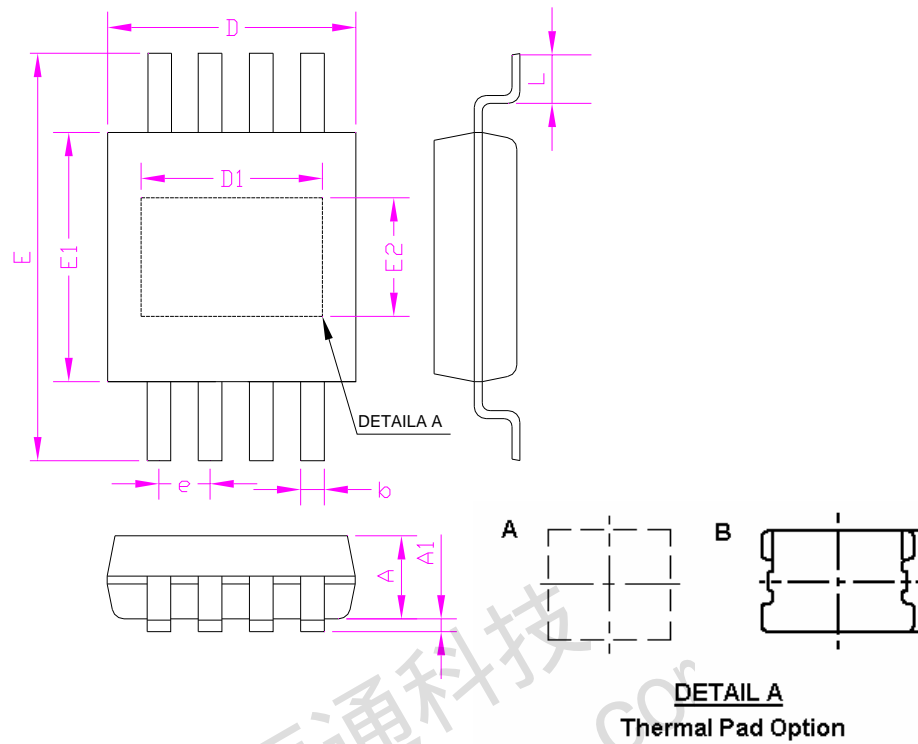

SYMBOLS	MILLIMETERS		INCHES	
	MIN.	MAX.	MIN.	MAX.
A	-	1.10	-	0.043
A1	0.00	0.15	0.000	0.006
D	3.00		0.118	
E	4.70	5.10	0.185	0.201
E1	3.00		0.118	
D1	1.28	2.30	0.050	0.091
E2	1.21	1.72	0.048	0.068
L	0.40	0.80	0.016	0.031
b	0.22	0.38	0.008	0.015
e	0.65		0.026	