

Automotive dual Transil™ array for ESD protection

Features

- Dual unidirectional Transil functions
- Low leakage current: I_R max. < 20 μ A at V_{BR}
- 300 W peak pulse power (8/20 μ s)

Benefits

- High ESD protection level: up to 25 kV
- High integration
- Suitable for high density boards
- AEC-Q101 qualified

Complies with the following standards

- ISO 10605: C = 150 pF, R = 330 Ω
 - 30 kV (air discharge)
 - 30 kV (contact discharge)
- ISO 10605: C = 330 pF, R = 330 Ω
 - 30 kV (air discharge)
 - 30 kV (contact discharge)
- ISO 7637-2^(a)
 - Pulse 1: $V_S = -100$ V
 - Pulse 2a: $V_S = +50$ V
 - Pulse 3a: $V_S = -150$ V
 - Pulse 3b: $V_S = +100$ V

Applications

Where transient overvoltage protection in ESD sensitive equipment is required, such as:

- Entertainment
- Signal communications
- Connectivity
- Comfort and convenience

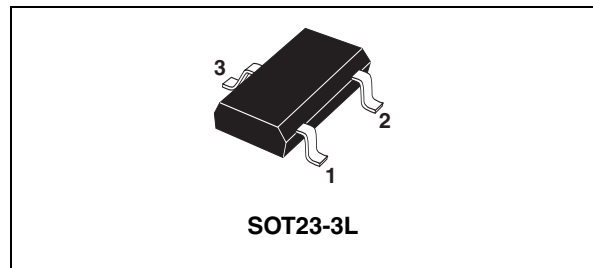
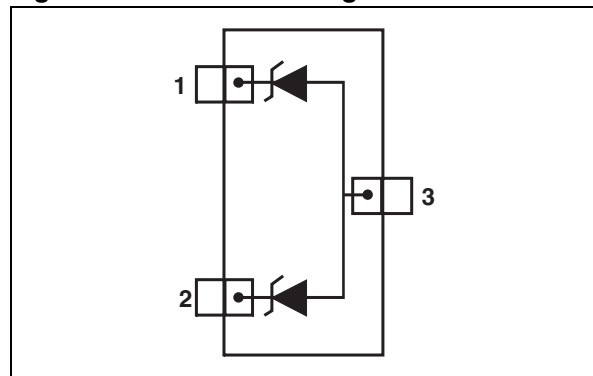

Figure 1. Functional diagram



Description

The ESDALY is a monolithic array designed to protect 1 line or 2 lines against ESD transients. The device is ideal for applications where both reduced line capacitance and board space saving are required. It can also be used as bidirectional suppressor by connecting only pin 1 and 2.

a. Not applicable to parts with stand-off voltage lower than the average battery voltage (13.5 V)

TM: Transil is a trademark of STMicroelectronics.

1 Characteristics

Table 1. Absolute maximum ratings ($T_{amb} = 25\text{ }^{\circ}\text{C}$)

Symbol	Parameter		Value	Unit
V_{PP}	Peak pulse voltage ⁽¹⁾	ISO 10605 (C = 330 pF, R = 330 Ω):		
		contact discharge	30	kV
		air discharge	30	
		ISO 10605: C = 150 pF, R = 330 Ω		
contact discharge	30			
	air discharge	30		
P_{PP}	Peak pulse power (8/20 μ s)		300	W
I_{PP}	Peak pulse current (8/20 μ s)	ESDA5V3LY	25	A
		ESDA6V1LY	18	
		ESDA14V2LY	14	
		ESDA25LY	7	
T_j	Operating junction temperature range		-40 to 150	$^{\circ}\text{C}$
T_{stg}	Storage temperature range		-65 to +150	$^{\circ}\text{C}$
T_L	Maximum lead temperature for soldering during 10 s at 5 mm from case		260	$^{\circ}\text{C}$

1. For a surge greater than the maximum values, the diode will fail in short-circuit.

Figure 2. Electrical characteristics (definitions)

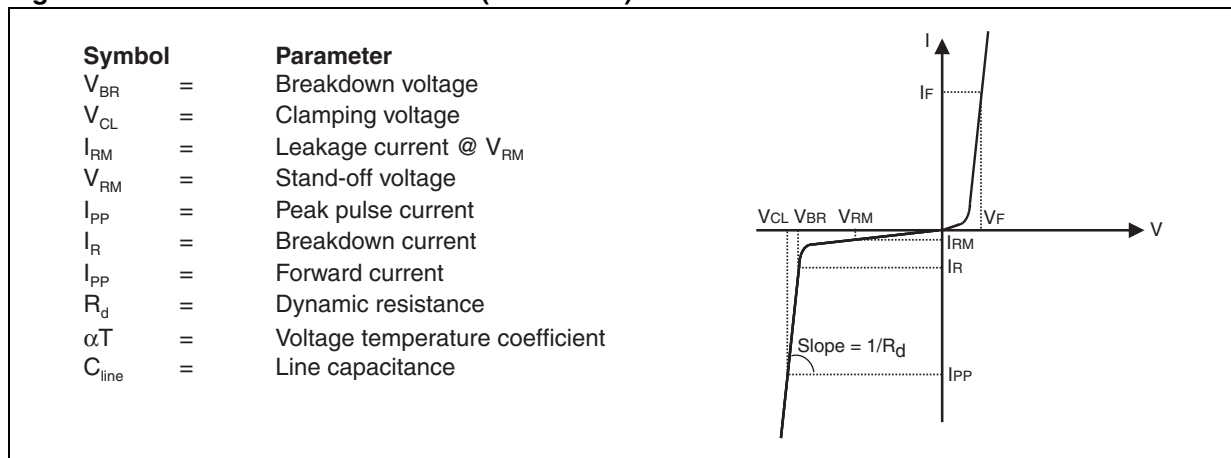

Table 2. Electrical characteristics (values, $T_{amb} = 25\text{ }^{\circ}\text{C}$)

Order code	$V_{BR} @ I_R$			$I_{RM} @ V_{RM}$		$V_{CL} @ I_{PP}^{(1)}$		$V_F @ I_F$		$R_d^{(2)}$	$\alpha T^{(3)}$	C_{line}
	Min.	Max.		Max.		Max.		Max.		Typ.	Max.	Typ.
	V	V	mA	μA	V	V	A	V	mA	$\text{m}\Omega$	$10^{-4}/^{\circ}\text{C}$	pF
ESDA5V3LY	5.3	5.9	1	2	3	19	25	1.25	200	280	5	220
ESDA6V1LY	6.1	7.2	1	20	5.2	16	18	1.25	200	350	6	140
ESDA14V2LY	14.2	15.8	1	5	12	21	14	1.25	200	650	10	90
ESDA25LY	25	30	1	1	24	43	7	1.2	10	1000	10	50

- 8/20 μs waveform
- Square pulse, $I_{pp} = 15\text{ A}$, $t_p = 2.5\text{ }\mu\text{s}$.
- $\Delta V_{BR} = \alpha T * (T_{amb} - 25\text{ }^{\circ}\text{C}) * V_{BR}(25\text{ }^{\circ}\text{C})$

Figure 3. Variation of peak pulse power versus initial junction temperature

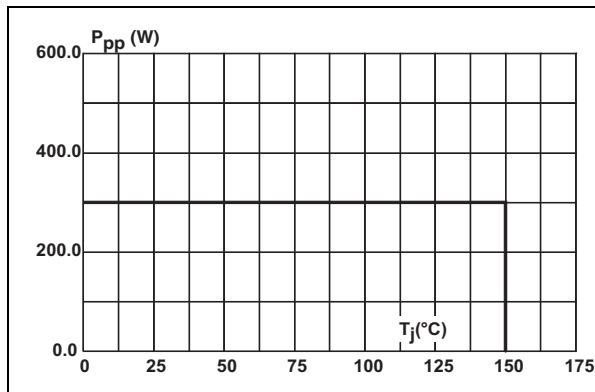

Figure 4. Peak pulse power versus exponential pulse duration (typical values)

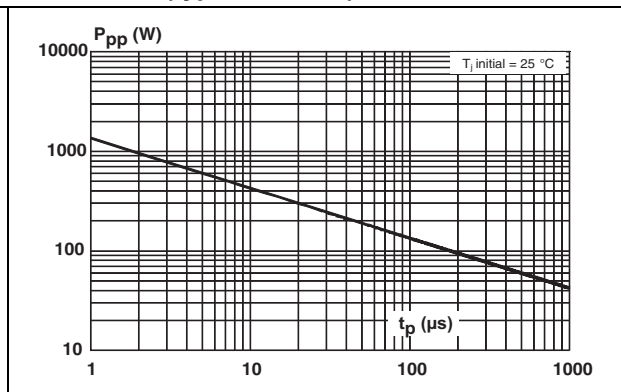

Figure 5. Variation of clamping voltage versus peak pulse current (max. values, 8/20 μs waveform)

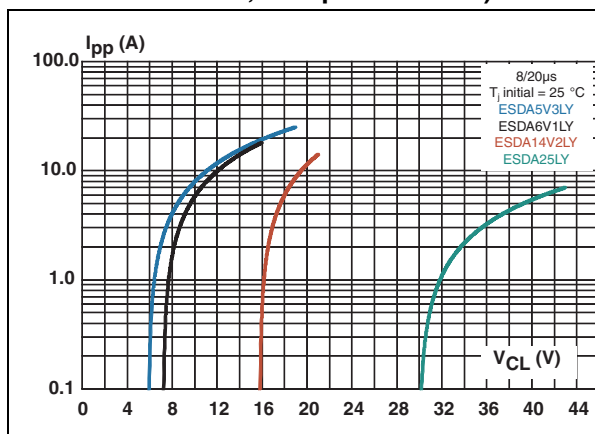

Figure 6. Relative variation of leakage current versus junction temperature (typical values)

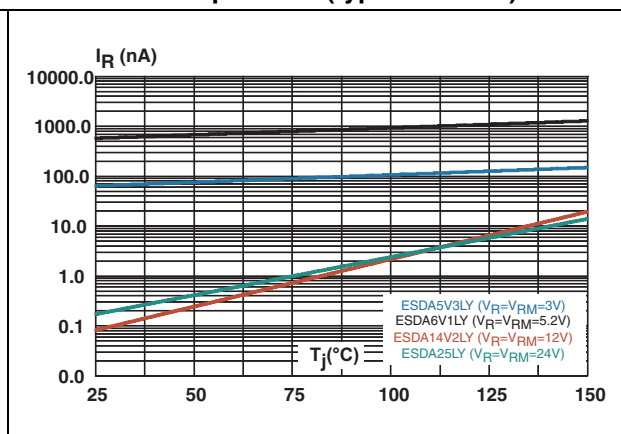

Figure 7. ISO 7637-2 pulse 1 response ($V_S = -100\text{ V}$)

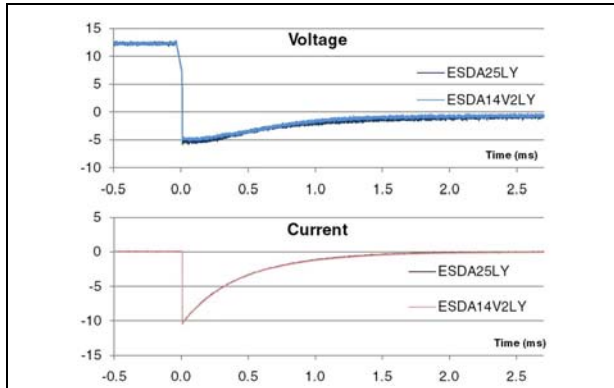

Figure 8. ISO 7637-2 pulse 2a response ($V_S = 50\text{ V}$)

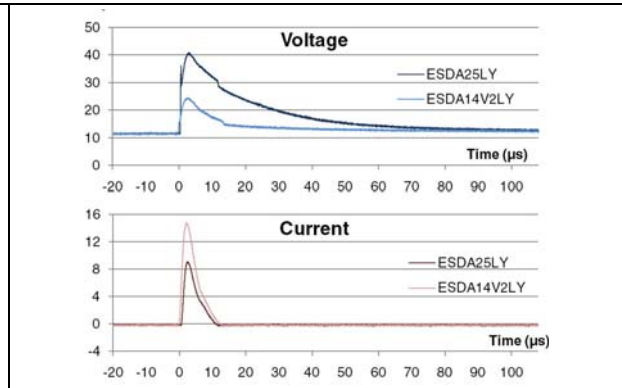

Figure 9. ISO 7637-2 pulse 3a response ($V_S = -150\text{ V}$)

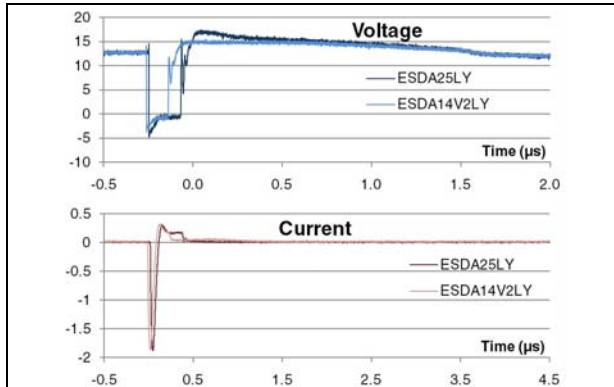
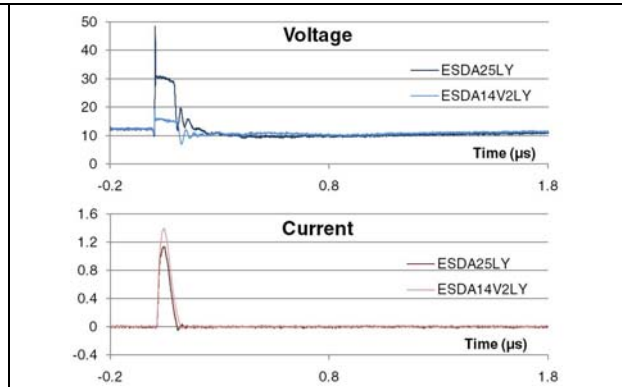

Figure 10. ISO 7637-2 pulse 3b response ($V_S = 100\text{ V}$)



Note: ISO7637-2 pulse responses are not applicable for products with a breakdown voltage lower than the average battery voltage (13.5 V) like ESDA5V3LY and ESDA6V1LY.

2 Application and design guidelines

More information is available in the application note:

AN2689, "Protection of automotive electronics from electrical hazards, guidelines for design and component selection".

3 Ordering information scheme

Figure 11. Ordering information scheme

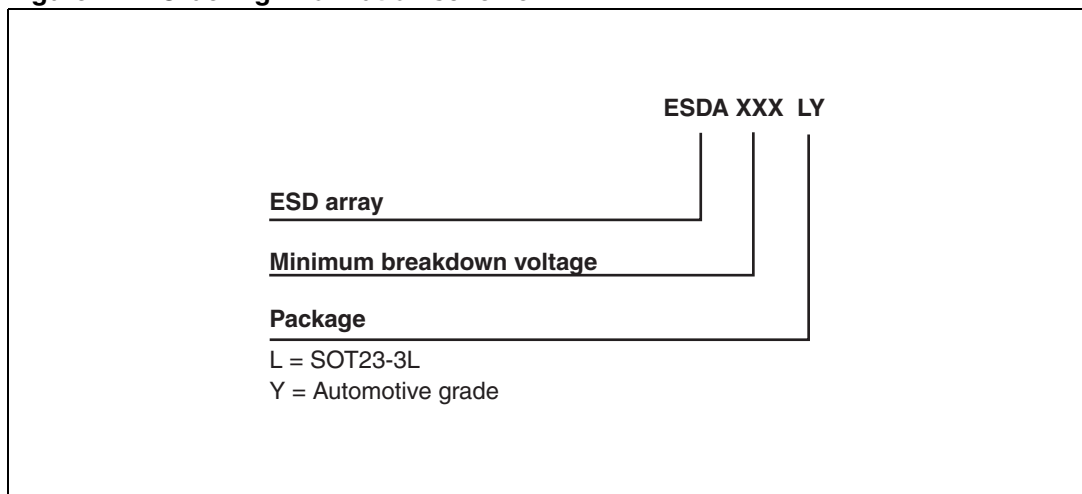

4 Package information

- Epoxy meets UL94, V0
- Lead-free package

In order to meet environmental requirements, ST offers these devices in different grades of ECOPACK® packages, depending on their level of environmental compliance. ECOPACK® specifications, grade definitions and product status are available at: www.st.com. ECOPACK® is an ST trademark.

Table 3. SOT23-3L dimensions

Ref.	Dimensions			
	Millimeters		Inches	
	Min.	Max.	Min.	Max.
A	0.89	1.4	0.035	0.055
A1	0	0.1	0	0.004
B	0.3	0.51	0.012	0.02
c	0.085	0.18	0.003	0.007
D	2.75	3.04	0.108	0.12
e	0.85	1.05	0.033	0.041
e1	1.7	2.1	0.067	0.083
E	1.2	1.6	0.047	0.063
H	2.1	2.75	0.083	0.108
L	0.6 typ.		0.024 typ.	
S	0.35	0.65	0.014	0.026

Figure 12. Footprint (dimensions in mm)

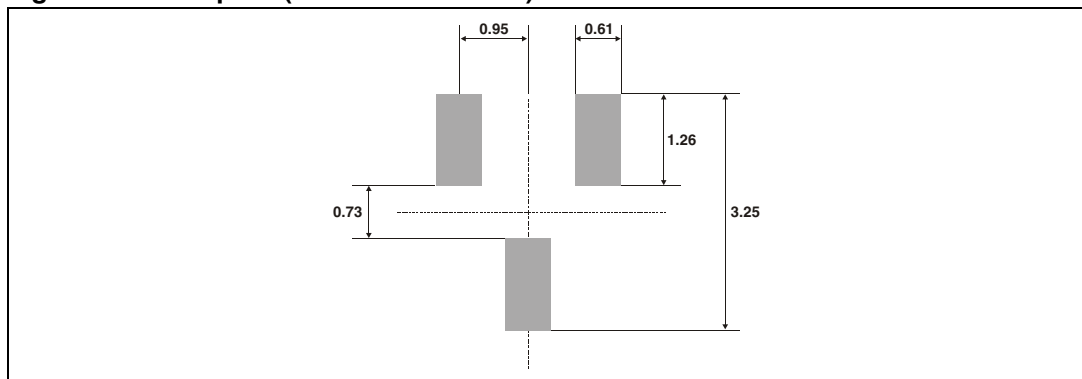

5.3 PCB design preference

1. To control the solder paste amount, the closed via is recommended instead of open vias.
2. The position of tracks and open vias in the solder area should be well balanced. The symmetrical layout is recommended, in case any tilt phenomena caused by asymmetrical solder paste amount due to the solder flow away.

5.4 Reflow profile

Figure 14. ST ECOPACK® recommended soldering reflow profile for PCB mounting

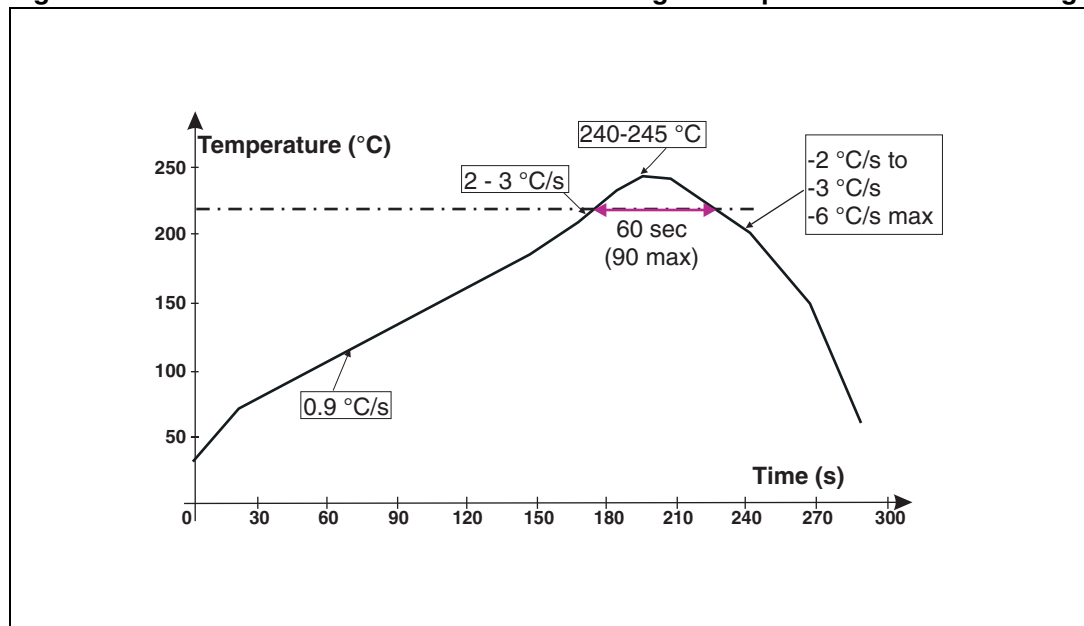

Note: Minimize air convection currents in the reflow oven to avoid component movement.

6 Ordering information

Table 4. Ordering information

Order code	Marking ⁽¹⁾	Package	Weight	Base qty	Delivery mode
ESDA5V3LY	EL5Y	SOT23-3L	8.7 mg	3000	Tape and reel
ESDA6V1LY	EL6Y				
ESDA14V2LY	EL1Y				
ESDA25LY	EL2Y				

1. The marking can be rotated by multiples of 90° to differentiate assembly location

7 Revision history

Table 5. Document revision history

Date	Revision	Changes
16-Feb-2012	1	Initial version. This document merges and updates the content of the datasheet ESDA25LY Revision 1, 01-Feb-2010.

Please Read Carefully:

Information in this document is provided solely in connection with ST products. STMicroelectronics NV and its subsidiaries ("ST") reserve the right to make changes, corrections, modifications or improvements, to this document, and the products and services described herein at any time, without notice.

All ST products are sold pursuant to ST's terms and conditions of sale.

Purchasers are solely responsible for the choice, selection and use of the ST products and services described herein, and ST assumes no liability whatsoever relating to the choice, selection or use of the ST products and services described herein.

No license, express or implied, by estoppel or otherwise, to any intellectual property rights is granted under this document. If any part of this document refers to any third party products or services it shall not be deemed a license grant by ST for the use of such third party products or services, or any intellectual property contained therein or considered as a warranty covering the use in any manner whatsoever of such third party products or services or any intellectual property contained therein.

UNLESS OTHERWISE SET FORTH IN ST'S TERMS AND CONDITIONS OF SALE ST DISCLAIMS ANY EXPRESS OR IMPLIED WARRANTY WITH RESPECT TO THE USE AND/OR SALE OF ST PRODUCTS INCLUDING WITHOUT LIMITATION IMPLIED WARRANTIES OF MERCHANTABILITY, FITNESS FOR A PARTICULAR PURPOSE (AND THEIR EQUIVALENTS UNDER THE LAWS OF ANY JURISDICTION), OR INFRINGEMENT OF ANY PATENT, COPYRIGHT OR OTHER INTELLECTUAL PROPERTY RIGHT.

UNLESS EXPRESSLY APPROVED IN WRITING BY TWO AUTHORIZED ST REPRESENTATIVES, ST PRODUCTS ARE NOT RECOMMENDED, AUTHORIZED OR WARRANTED FOR USE IN MILITARY, AIR CRAFT, SPACE, LIFE SAVING, OR LIFE SUSTAINING APPLICATIONS, NOR IN PRODUCTS OR SYSTEMS WHERE FAILURE OR MALFUNCTION MAY RESULT IN PERSONAL INJURY, DEATH, OR SEVERE PROPERTY OR ENVIRONMENTAL DAMAGE. ST PRODUCTS WHICH ARE NOT SPECIFIED AS "AUTOMOTIVE GRADE" MAY ONLY BE USED IN AUTOMOTIVE APPLICATIONS AT USER'S OWN RISK.

Resale of ST products with provisions different from the statements and/or technical features set forth in this document shall immediately void any warranty granted by ST for the ST product or service described herein and shall not create or extend in any manner whatsoever, any liability of ST.

ST and the ST logo are trademarks or registered trademarks of ST in various countries.

Information in this document supersedes and replaces all information previously supplied.

The ST logo is a registered trademark of STMicroelectronics. All other names are the property of their respective owners.

© 2012 STMicroelectronics - All rights reserved

STMicroelectronics group of companies

Australia - Belgium - Brazil - Canada - China - Czech Republic - Finland - France - Germany - Hong Kong - India - Israel - Italy - Japan - Malaysia - Malta - Morocco - Philippines - Singapore - Spain - Sweden - Switzerland - United Kingdom - United States of America

www.st.com