

## Optocoupler, Photodarlington Output, AC Input, High Gain

### Features

- $BV_{CEO} > 60\text{ V}$
- Isolation Test Voltage,  $5300\text{ V}_{RMS}$
- AC or Polarity Insensitive Inputs
- No Base Connection
- High Isolation Resistance,  $10^{12}\ \Omega$
- Low Coupling Capacitance
- Standard Plastic DIP Package

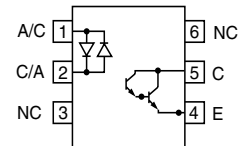
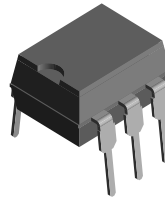

1179038

### Agency Approvals

- UL File #E52744 System Code H or J
- DIN EN 60747-5-2(VDE0884)  
DIN EN 60747-5-5 pending  
Available with Option 1
- CSA 93751
- BSI IEC60950 IEC60965
- FIMKO

### Order Information

Part	Remarks
IL755B-1	CTR > 750 %, DIP-6
IL755B-2	CTR > 1000 %, DIP-6

For additional information on the available options refer to Option Information.

### Description

The IL755B is a bidirectional input, optically coupled isolator consisting of two Gallium Arsenide infrared emitters and a silicon photodarlington sensor.

### Absolute Maximum Ratings

$T_{amb} = 25\text{ }^{\circ}\text{C}$ , unless otherwise specified

Stresses in excess of the absolute Maximum Ratings can cause permanent damage to the device. Functional operation of the device is not implied at these or any other conditions in excess of those given in the operational sections of this document. Exposure to absolute Maximum Rating for extended periods of the time can adversely affect reliability.

### Input

Parameter	Test condition	Symbol	Value	Unit
Forward continuous current		$I_F$	60	mA
Power dissipation		$P_{diss}$	100	mW
Derate linearly from $55\text{ }^{\circ}\text{C}$			1.33	mW/ $^{\circ}\text{C}$

### Output

Parameter	Test condition	Symbol	Value	Unit
Collector-emitter breakdown voltage		$BV_{CEO}$	60	V
Emitter-collector breakdown voltage		$BV_{ECO}$	12	V
Power dissipation		$P_{diss}$	200	mW
Derate linearly from $25\text{ }^{\circ}\text{C}$			2.6	mW/ $^{\circ}\text{C}$

### Coupler

Parameter	Test condition	Symbol	Value	Unit
Isolation test voltage (PK)	t = 1.0 sec.	$V_{ISO}$	5300	$V_{RMS}$
Dissipation at 25 °C			250	mW
Derate linearly from 25 °C			3.3	mW/°C
Creepage			≥ 7	mm
Clearance			≥ 7	mm
Isolation Resistance	$T_{amb} = 25\text{ °C}$	$R_{IO}$	$10^{12}$	$\Omega$
	$T_{amb} = 100\text{ °C}$	$R_{IO}$	$10^{11}$	$\Omega$
Storage temperature		$T_{stg}$	- 55 to + 150	°C
Operating temperature		$T_{amb}$	- 55 to + 100	°C
Lead soldering time at 260 °C		$T_{sld}$	10	sec.

### Electrical Characteristics

$T_{amb} = 25\text{ °C}$ , unless otherwise specified

Minimum and maximum values are testing requirements. Typical values are characteristics of the device and are the result of engineering evaluation. Typical values are for information only and are not part of the testing requirements.

### Input

Parameter	Test condition	Symbol	Min	Typ.	Max	Unit
Forward voltage <sup>1)</sup>	$I_F = 10\text{ mA}$	$V_F$		1.25	1.5	V

<sup>1)</sup> Indicates JEDEC registered data.

### Output

Parameter	Test condition	Symbol	Min	Typ.	Max	Unit
Collector-emitter breakdown voltage	$I_C = 1.0\text{ mA}$ , $I_F = 0$	$BV_{CEO}$	60	75		V
Collector-emitter leakage current	$V_{CE} = 10\text{ V}$ , $I_F = 0$	$I_{CEO}$		1.0	100	nA

### Coupler

Parameter	Test condition	Symbol	Min	Typ.	Max	Unit
Saturation voltage, collector-emitter	$I_C = 10\text{ mA}$ , $I_F = \pm 10\text{ mA}$	$V_{CEsat}$			1.0	V

### Current Transfer Ratio

Parameter	Test condition	Part	Symbol	Min	Typ.	Max	Unit
Current Transfer Ratio	$V_{CE} = 5.0\text{ V}$ , $I_F = \pm 2.0\text{ mA}$	IL755B-1	CTR	750			%
		IL755B-2	CTR	1000			%

## Switching Characteristics

Parameter	Test condition	Symbol	Min	Typ.	Max	Unit
Turn-on time	$V_{CC} = 10\text{ V}$ , $I_F = \pm 2.0\text{ mA}$ , $R_L = 100\ \Omega$	$t_{on}$			200	$\mu\text{s}$
Turn-off time	$V_{CC} = 10\text{ V}$ , $I_F = \pm 2.0\text{ mA}$ , $R_L = 100\ \Omega$	$t_{off}$			200	$\mu\text{s}$

## Typical Characteristics ( $T_{amb} = 25\text{ }^\circ\text{C}$ unless otherwise specified)

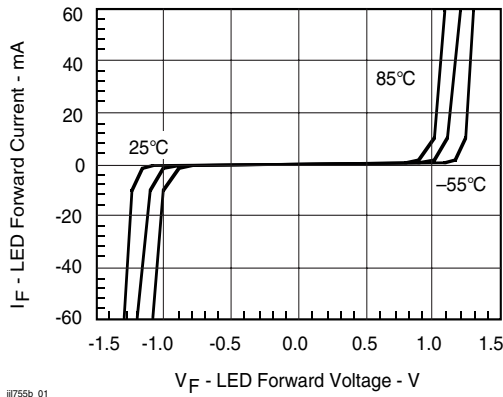

#1755b\_01

Fig. 1 LED Forward Current vs. Forward Voltage

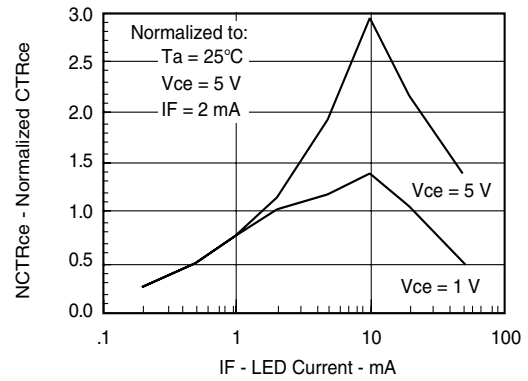

#1755b\_03

Fig. 3 Normalized Non-saturated and Saturated  $CTR_{CE}$  vs. LED Current

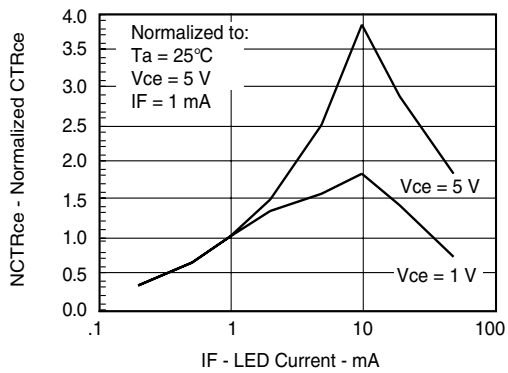

#1755b\_02

Fig. 2 Normalized Non-saturated and Saturated  $CTR_{CE}$  vs. LED Current

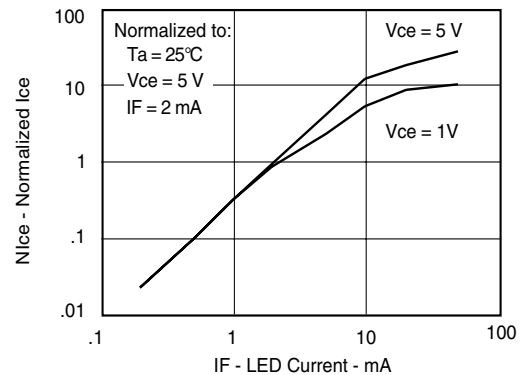

#1755b\_04

Fig. 4 Normalized Non-Saturated and Saturated  $I_{CE}$  vs. LED Current

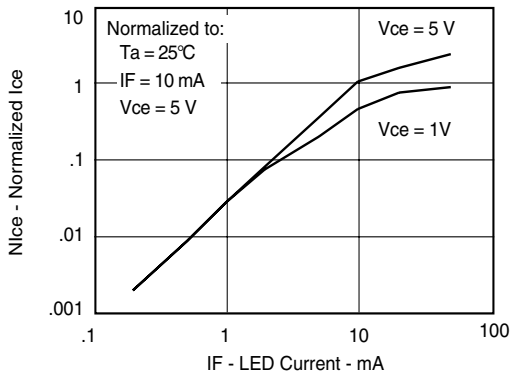

#755b\_05

Fig. 5 Normalized Non-Saturated and Saturated Collector-Emitter Current vs. LED Current

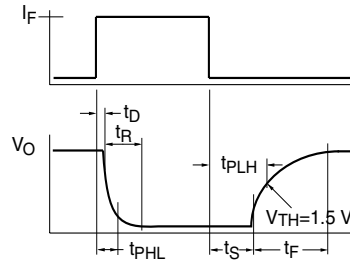

#755b\_08

Fig. 8 Switching Waveform

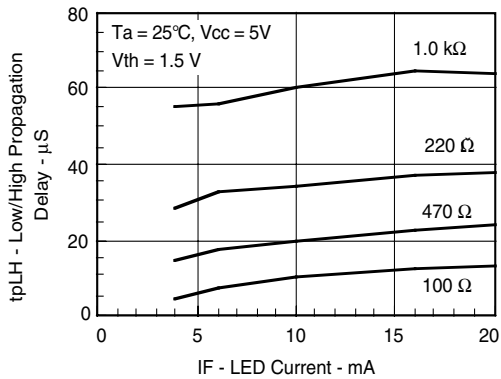

#755b\_06

Fig. 6 Low to High Propagation Delay vs. Collector Load Resistance and LED Current

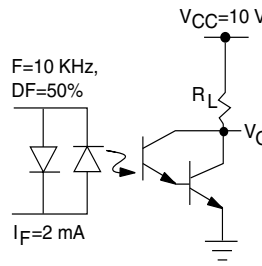

#755b\_09

Fig. 9 Normalized Non-saturated and Saturated  $CTR_{CE}$  vs. LED Current

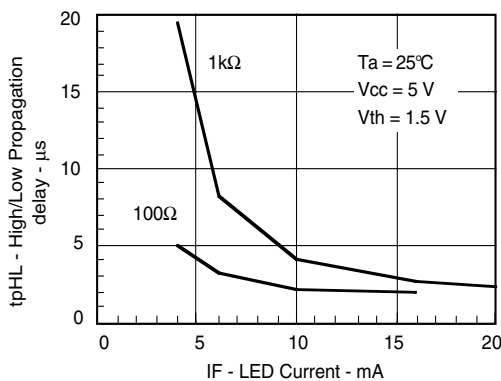

#755b\_07

Fig. 7 High to low Propagation Delay vs. Collector Load Resistance and LED Current

## Package Dimensions in Inches (mm)

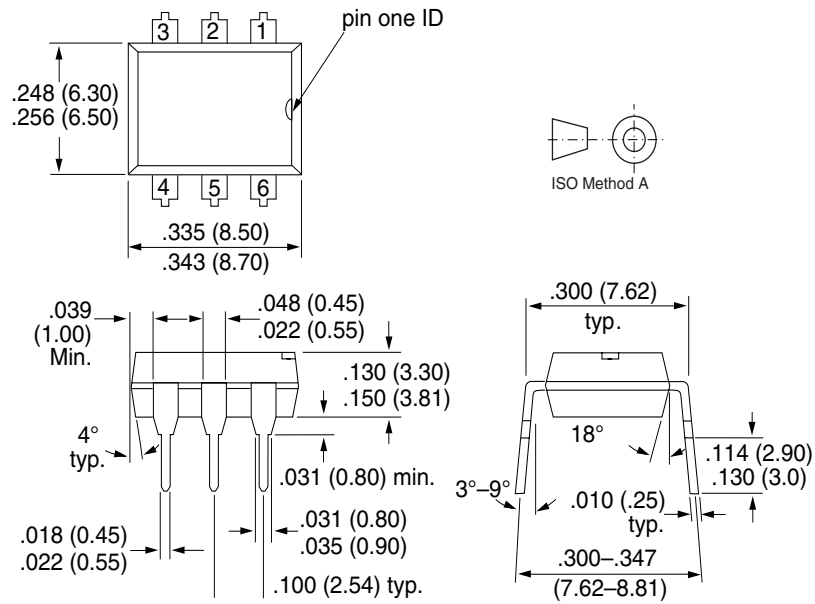

i178004

### Ozone Depleting Substances Policy Statement

It is the policy of **Vishay Semiconductor GmbH** to

1. Meet all present and future national and international statutory requirements.
2. Regularly and continuously improve the performance of our products, processes, distribution and operating systems with respect to their impact on the health and safety of our employees and the public, as well as their impact on the environment.

It is particular concern to control or eliminate releases of those substances into the atmosphere which are known as ozone depleting substances (ODSs).

The Montreal Protocol (1987) and its London Amendments (1990) intend to severely restrict the use of ODSs and forbid their use within the next ten years. Various national and international initiatives are pressing for an earlier ban on these substances.

**Vishay Semiconductor GmbH** has been able to use its policy of continuous improvements to eliminate the use of ODSs listed in the following documents.

1. Annex A, B and list of transitional substances of the Montreal Protocol and the London Amendments respectively
2. Class I and II ozone depleting substances in the Clean Air Act Amendments of 1990 by the Environmental Protection Agency (EPA) in the USA
3. Council Decision 88/540/EEC and 91/690/EEC Annex A, B and C (transitional substances) respectively.

**Vishay Semiconductor GmbH** can certify that our semiconductors are not manufactured with ozone depleting substances and do not contain such substances.

**We reserve the right to make changes to improve technical design  
and may do so without further notice.**

Parameters can vary in different applications. All operating parameters must be validated for each customer application by the customer. Should the buyer use Vishay Semiconductors products for any unintended or unauthorized application, the buyer shall indemnify Vishay Semiconductors against all claims, costs, damages, and expenses, arising out of, directly or indirectly, any claim of personal damage, injury or death associated with such unintended or unauthorized use.

Vishay Semiconductor GmbH, P.O.B. 3535, D-74025 Heilbronn, Germany  
Telephone: 49 (0)7131 67 2831, Fax number: 49 (0)7131 67 2423