

## Common mode filter with ESD protection for MIPI D-PHY and MDDI interface

Datasheet – production data

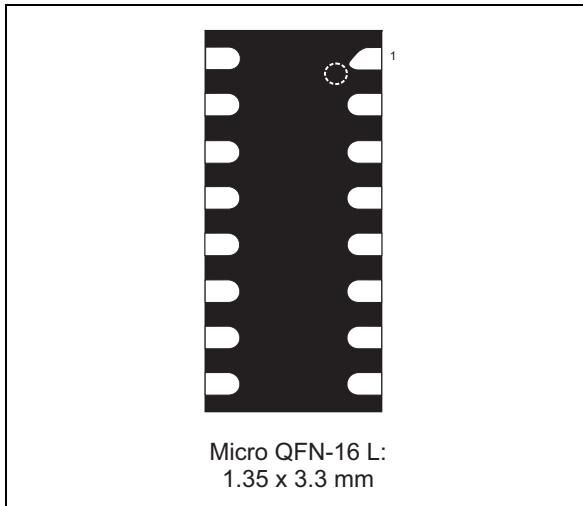

### Features

- Very large differential bandwidth: higher than 6 GHz
- High common mode attenuation:
  - -24 dB at 900 MHz
  - -20 dB between 800 MHz and 2.2 GHz
- Very low PCB space consumption
- Thin package: 0.55 mm max
- Lead-free package
- High reduction of parasitic elements through integration

### Complies with the following standards:

- IEC 61000-4-2 level 4:
  - ±15 kV (air discharge)
  - ±8 kV (contact discharge)

### Applications

- Mobile phones
- Notebook, laptop
- Portable devices

### Description

The ECMF06-6AM16 is a highly integrated common mode filter designed to suppress EMI/RFI common mode noise on high speed differential serial buses like MIPI D-PHY or MDDI.

The ECMF06-6AM16 can protect and filter 3 differential lanes.

Figure 1. Pin configuration (top view)

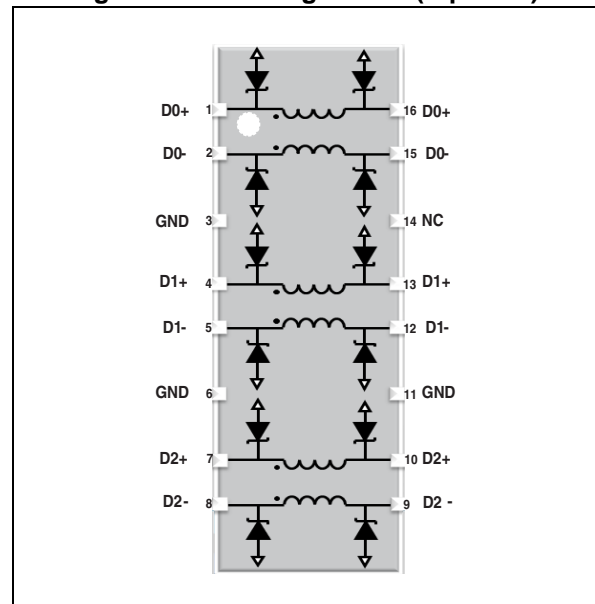

# 1 Characteristics

**Table 1. Absolute maximum ratings ( $T_{amb} = 25\text{ °C}$ )**

Symbol	Parameter		Value	Unit
$V_{PP}$	Peak pulse voltage	IEC 61000-4-2 contact discharge	10	kV
		IEC 61000-4-2 air discharge	30	
$I_{DC}$	Maximum DC current		100	mA
$T_{op}$	Operating temperature		-40 to +85	°C
$T_j$	Maximum junction temperature		125	°C
$T_{stg}$	Storage temperature range		- 55 to +150	°C

**Figure 2. Electrical characteristics (definitions)**

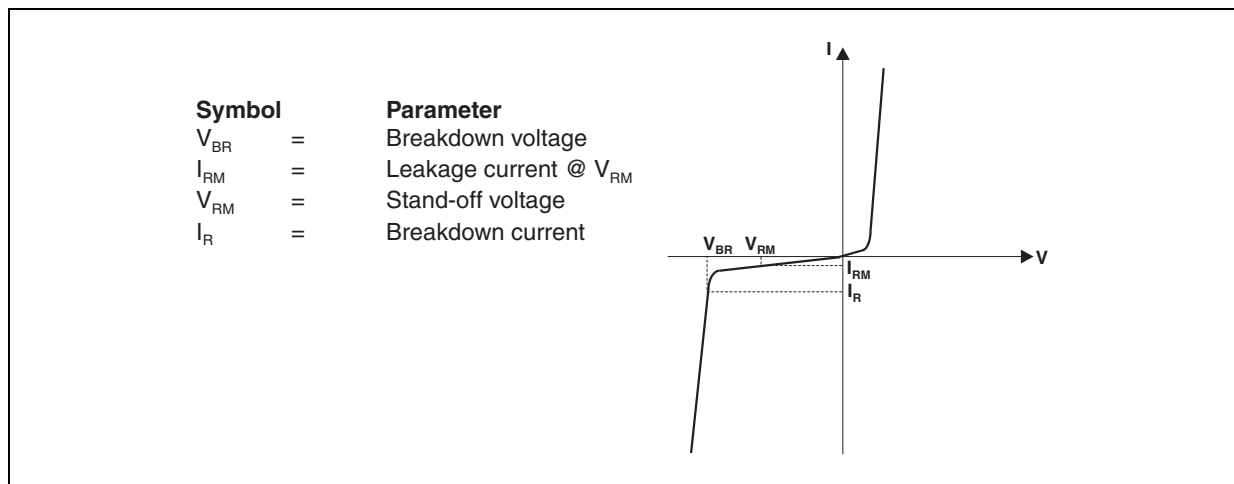

**Table 2. Electrical characteristics (values,  $T_{amb} = 25\text{ °C}$ )**

Symbol	Test conditions	Min.	Typ.	Max.	Unit
$V_{BR}$	$I_R = 1\text{ mA}$	6			V
$I_{RM}$	$V_{RM} = 3\text{ V per line}$			100	nA
$R_{DC}$	DC serial resistance		2.7	4	$\Omega$

Table 3. Pin description

Pin name	Description	Pin name	Description	Pin name	Description	Pin name	Description
1	D0+ DSI receiver	5	D1- DSI receiver	9	D2- DSI transmitter	13	D1+ DSI transmitter
2	D0- DSI receiver	6	GND DSI receiver	10	D2+ DSI transmitter	14	NC DSI transmitter
3	GND DSI receiver	7	D2+ DSI receiver	11	GND DSI transmitter	15	D0- DSI transmitter
4	D1+ DSI receiver	8	D2- DSI receiver	12	D1- DSI transmitter	16	D0+ DSI transmitter

Figure 3. SDD21 differential attenuation measurement ( $Z_{0\text{ diff}} = 100 \Omega$ )

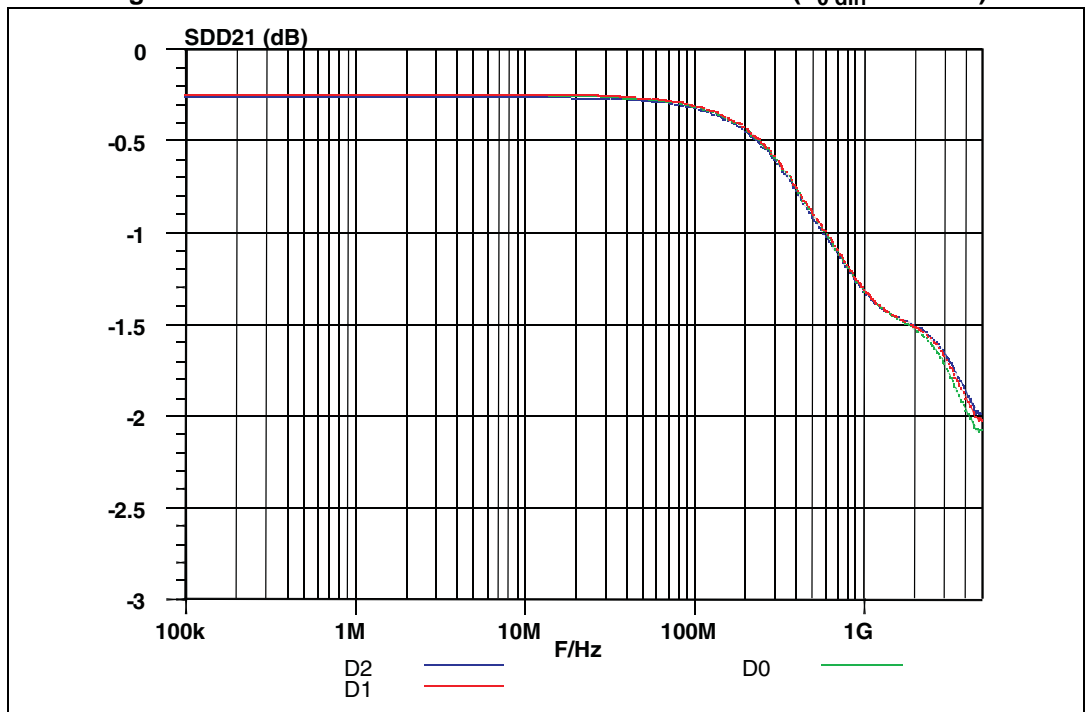

Figure 4. SCC21 common mode attenuation measurement ( $Z_{0\text{ com}} = 50 \Omega$ )

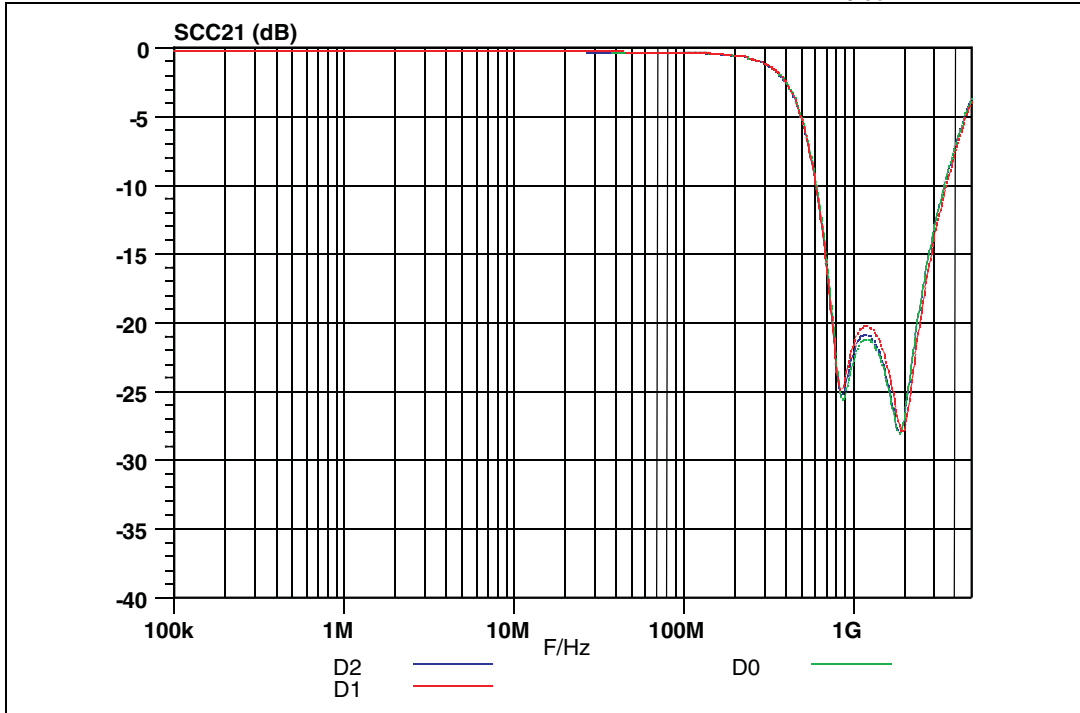

Figure 5. SDD11 differential return loss measurement ( $Z_{0\text{ diff}} = 100 \Omega$ )

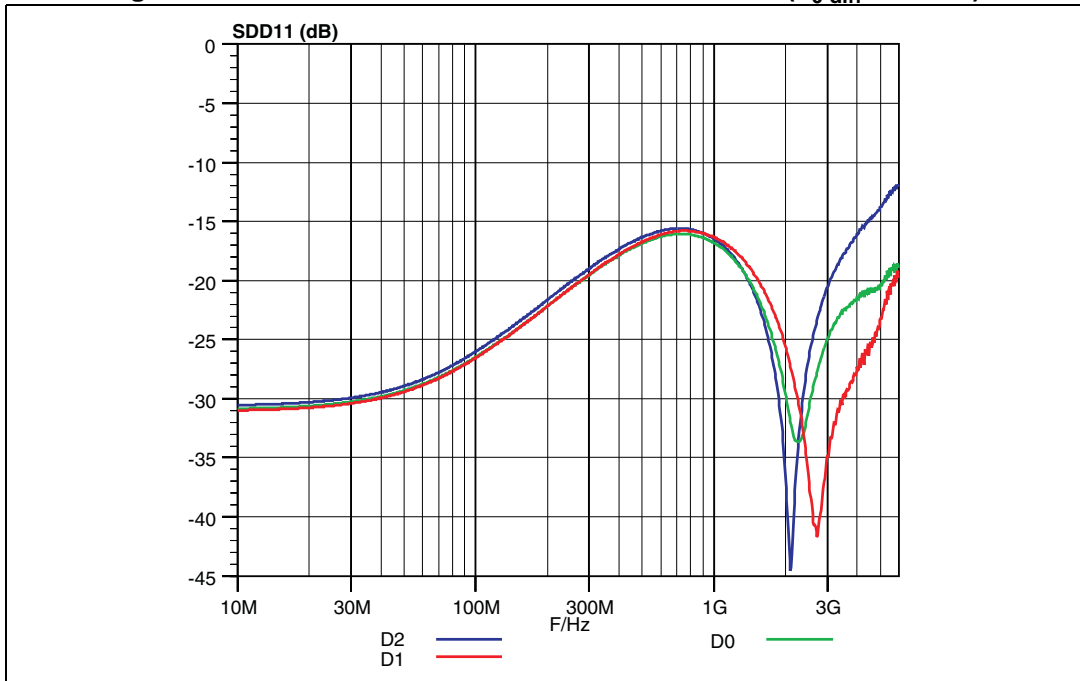

Figure 6. SDD22 differential attenuation measurement ( $Z_{0\text{ diff}} = 100 \Omega$ )

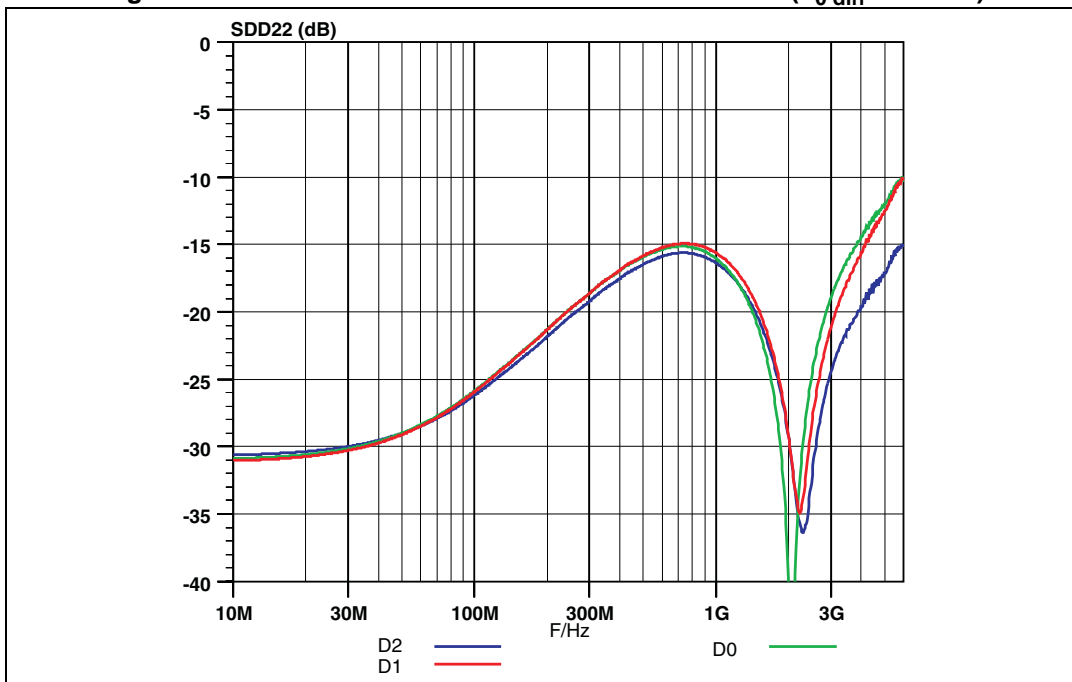

Figure 7. SDDxx inter-lane differential cross-coupling measurement ( $Z_{0\text{ diff}} = 100 \Omega$ )

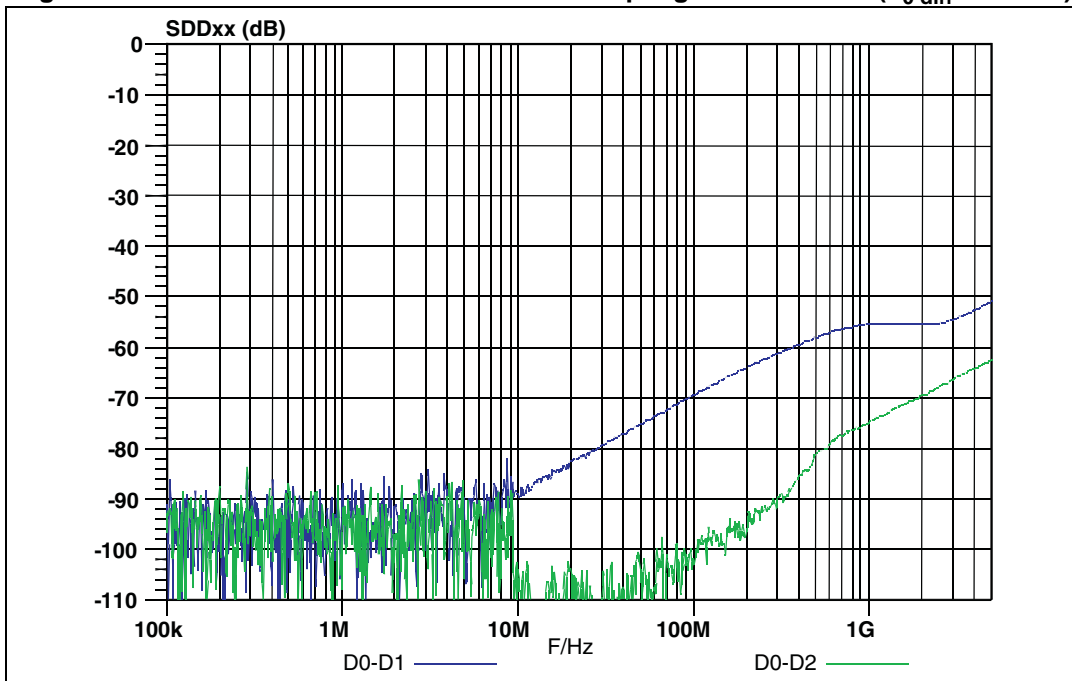

Figure 8. SCCxx inter-lane common-mode cross-coupling measurement  
( $Z_{0\text{ diff}} = 100 \Omega$ )

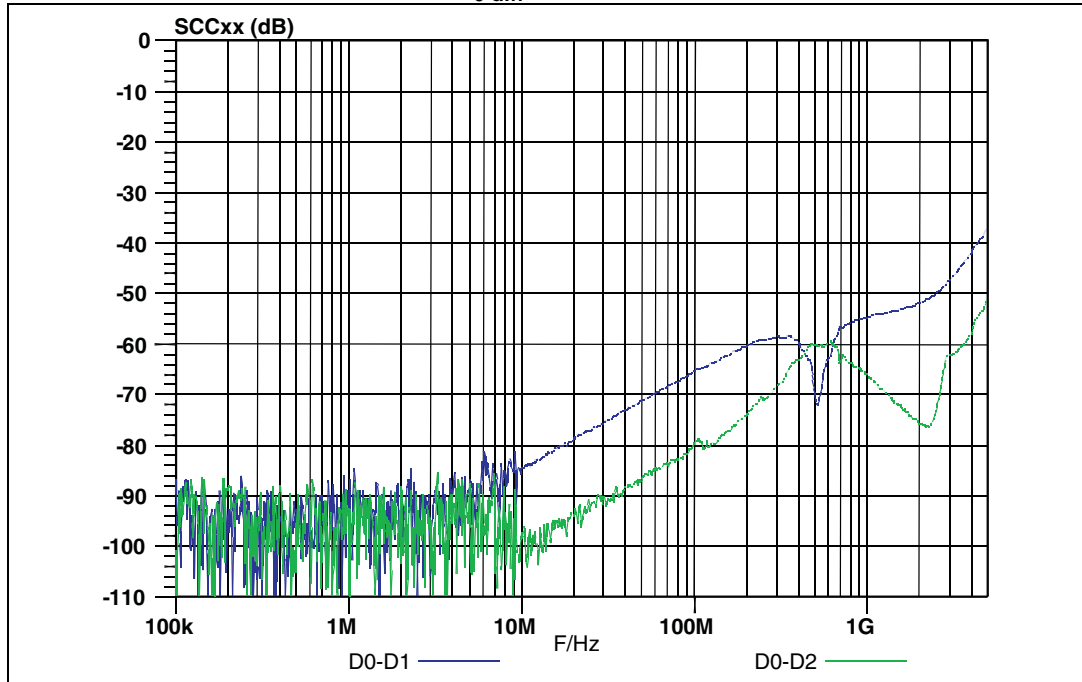

Figure 9. MIPI D-PHY low power mode test setup

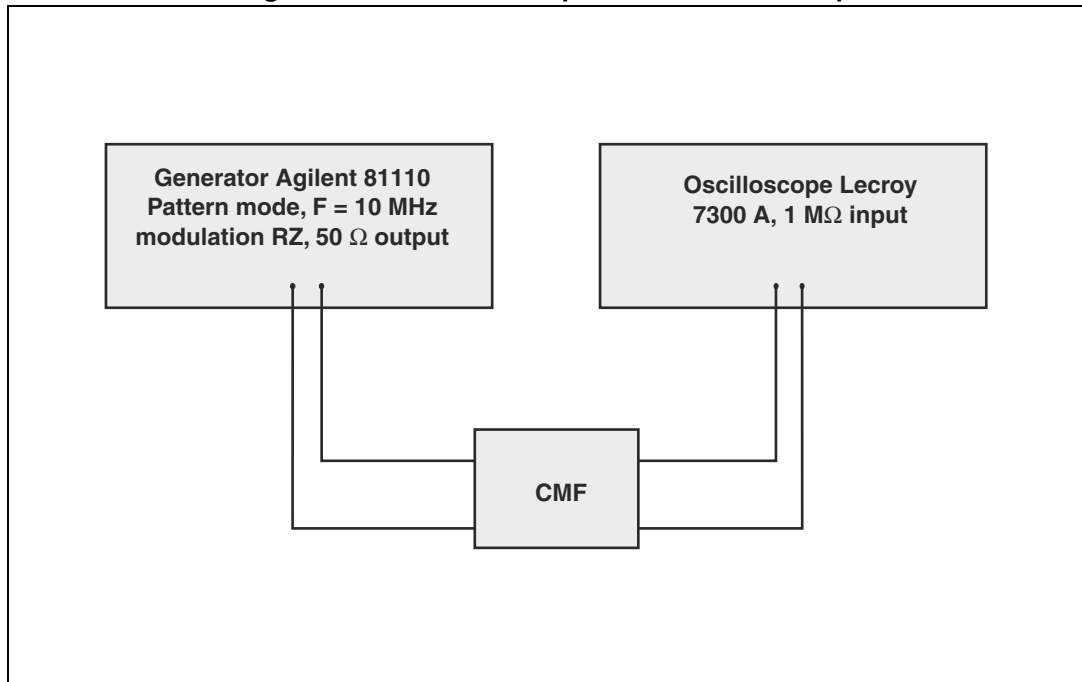

Figure 10. Low power pulse response - see Figure 9 for test setup

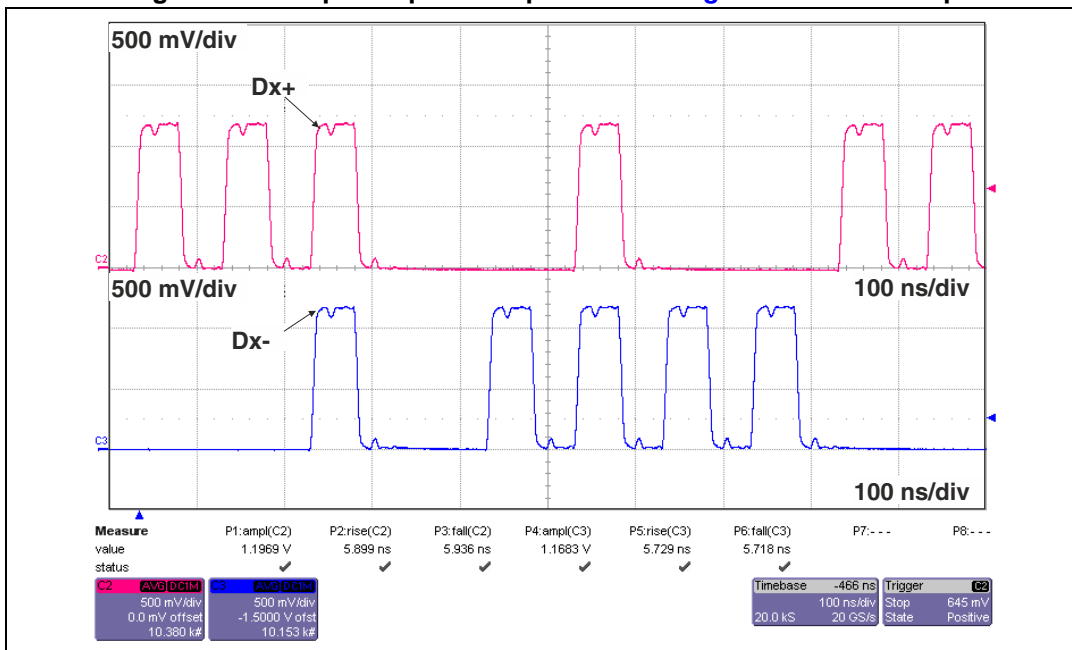

Figure 11. ESD response to IEC61000-4-2 (+8 kV contact discharge) - see Figure 13 for test set-up

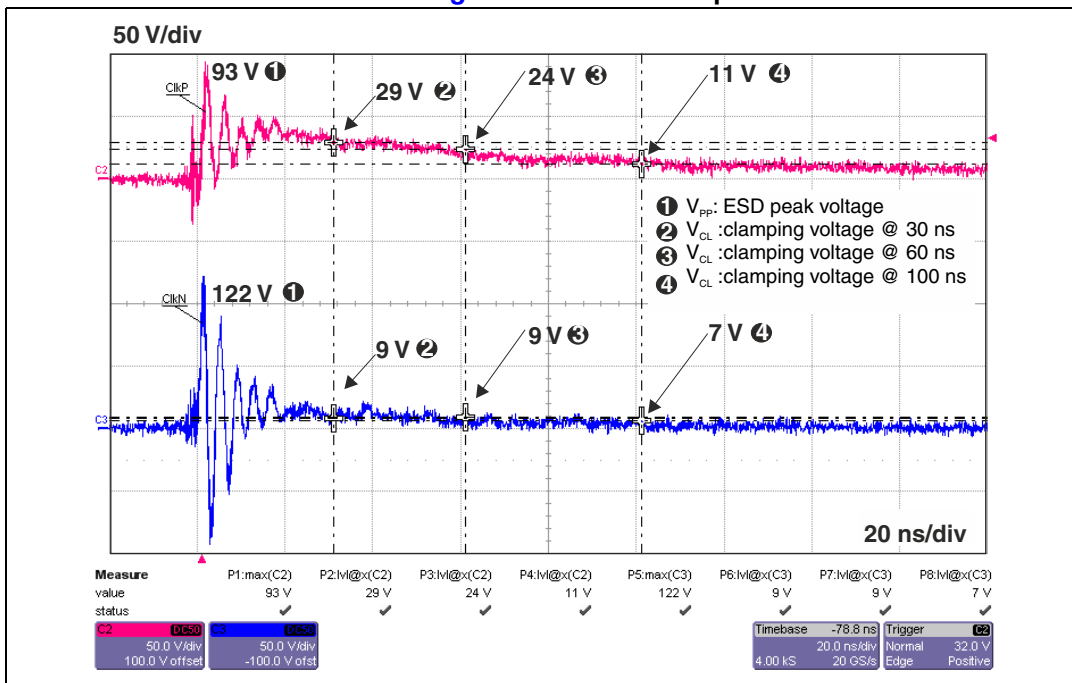

Figure 12. ESD response to IEC61000-4-2 (-8 kV contact discharge)  
 - see Figure 13 for test set-up

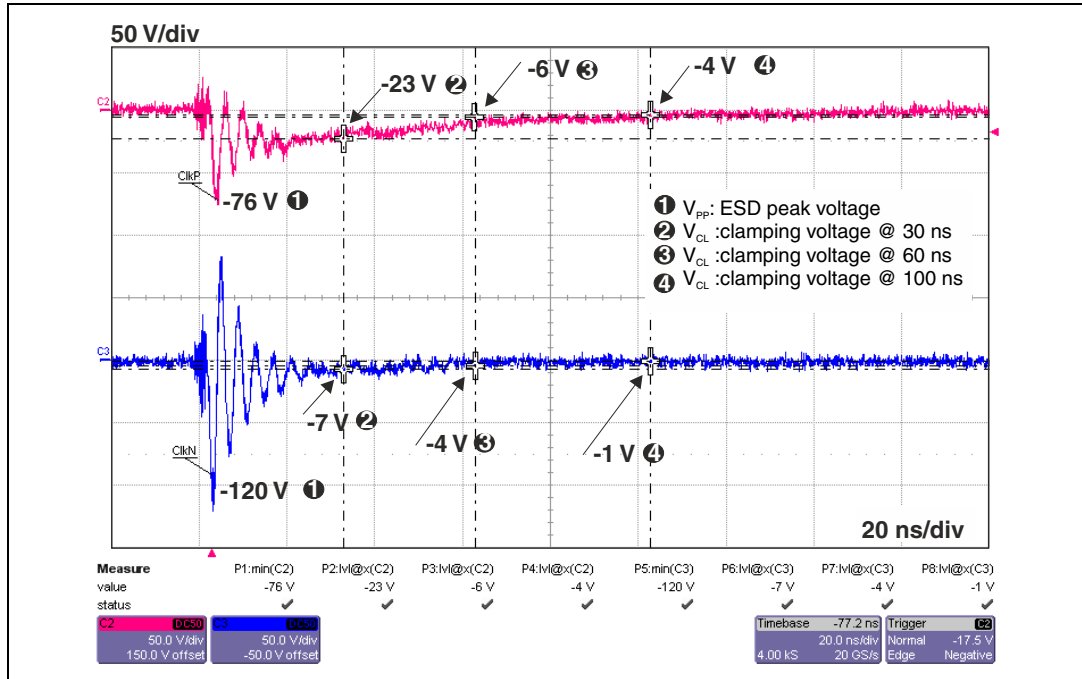
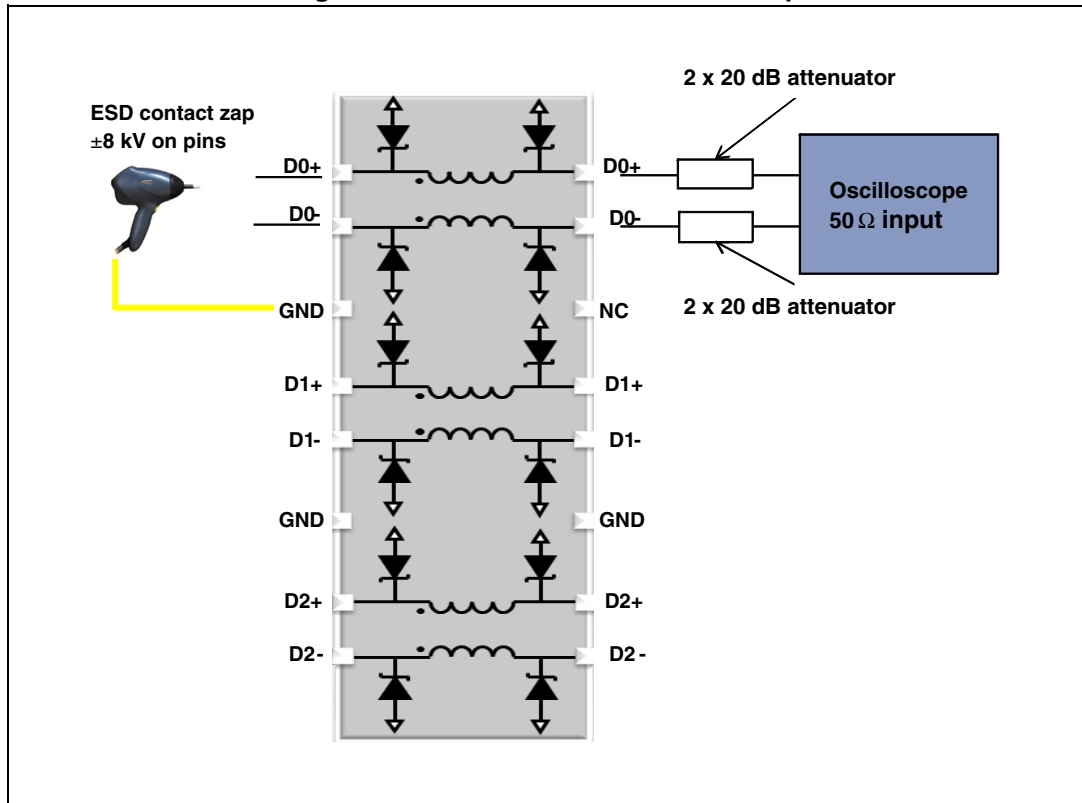

Figure 13. ESD measurement test set-up





## 2 Application information

Figure 14. Application information

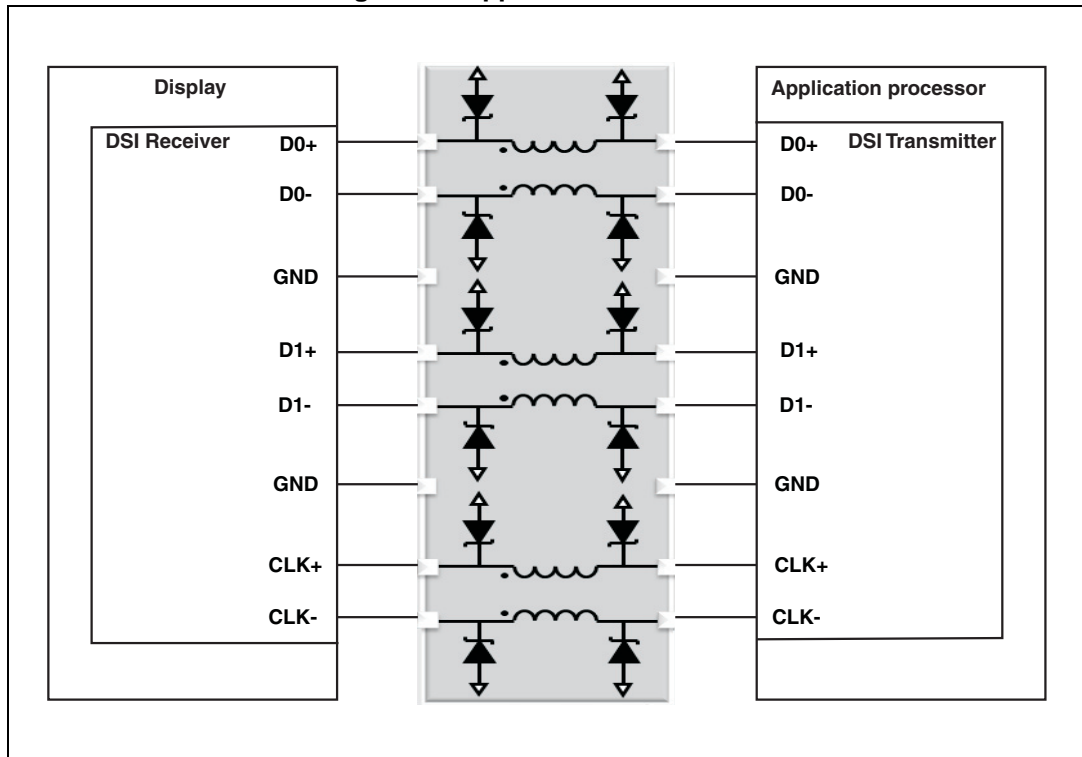

### 3 Package information

- Epoxy meets UL94, V0
- Lead-free packages

In order to meet environmental requirements, ST offers these devices in different grades of ECOPACK® packages, depending on their level of environmental compliance. ECOPACK® specifications, grade definitions and product status are available at: [www.st.com](http://www.st.com). ECOPACK® is an ST trademark.

Figure 15. Micro QFN 3.3 x 1.35 16L package dimension definitions

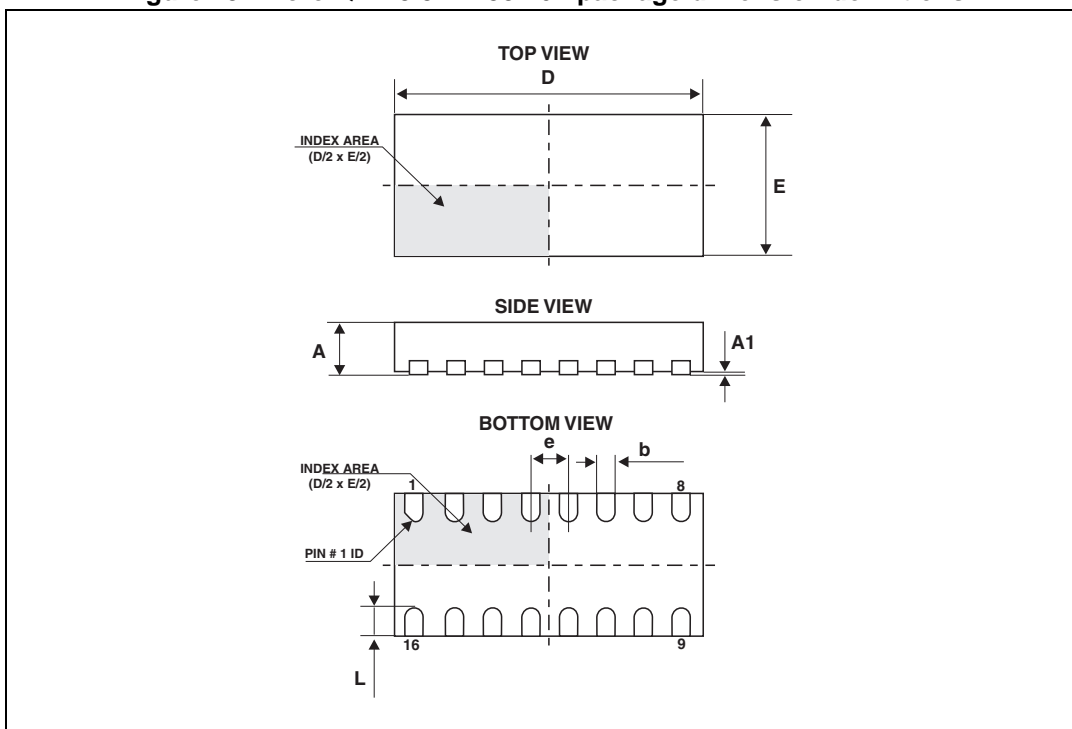

Table 4. Micro QFN 3.3 x 1.35 16L package dimension values

Ref.	Dimensions					
	Millimeters			Inches		
	Min.	Typ.	Max.	Min.	Typ.	Max.
A	0.45	0.50	0.55	0.018	0.020	0.022
A1	0.00	0.02	0.05	0.00	0.0008	0.002
b	0.15	0.20	0.25	0.006	0.008	0.010
D	3.25	3.30	3.35	0.128	0.130	0.132
E	1.30	1.35	1.40	0.051	0.053	0.055
e	0.35	0.40	0.45	0.014	0.016	0.018
L	0.30	0.40	0.50	0.118	0.016	0.020

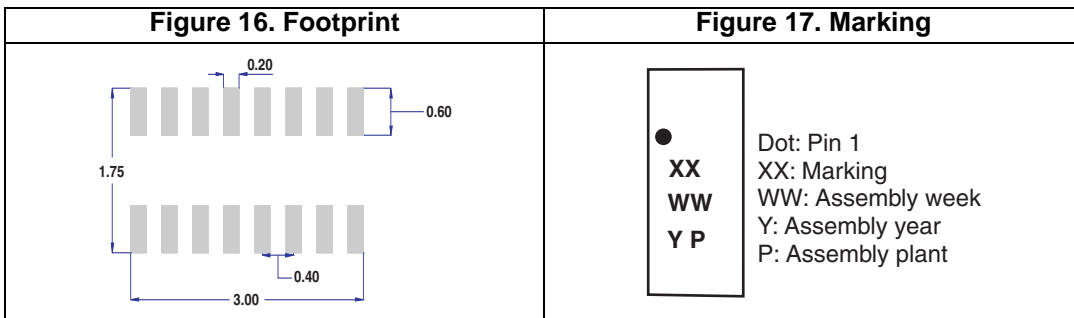
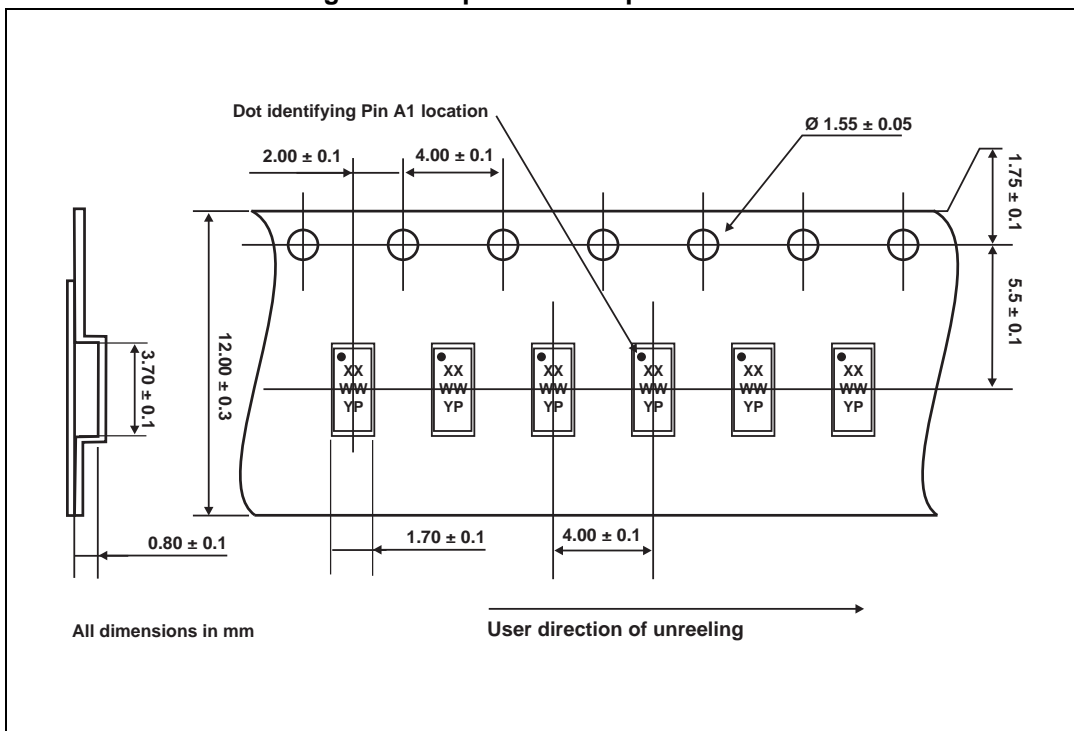

Figure 18. Tape and reel specifications



## 4 Recommendation on PCB assembly

### 4.1 Stencil opening design

1. General recommendation on stencil opening design
  - a) Stencil opening dimensions: L (Length), W (Width), T (Thickness).

Figure 19. Stencil opening dimensions

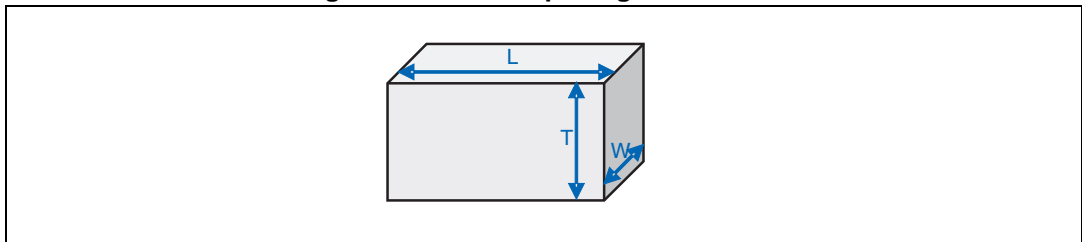

- b) General design rule
  - Stencil thickness (T) = 75 ~ 125 μm
  - Aspect Ratio =  $\frac{W}{T} \geq 1.5$
  - Aspect Area =  $\frac{L \times W}{2T(L + W)} \geq 0.66$

2. Reference design
  - a) Stencil opening thickness: 100 μm
  - b) Stencil opening for central exposed pad: Opening to footprint ratio is 50%.
  - c) Stencil opening for leads: Opening to footprint ratio is 90%.

Figure 20. Recommended stencil window position

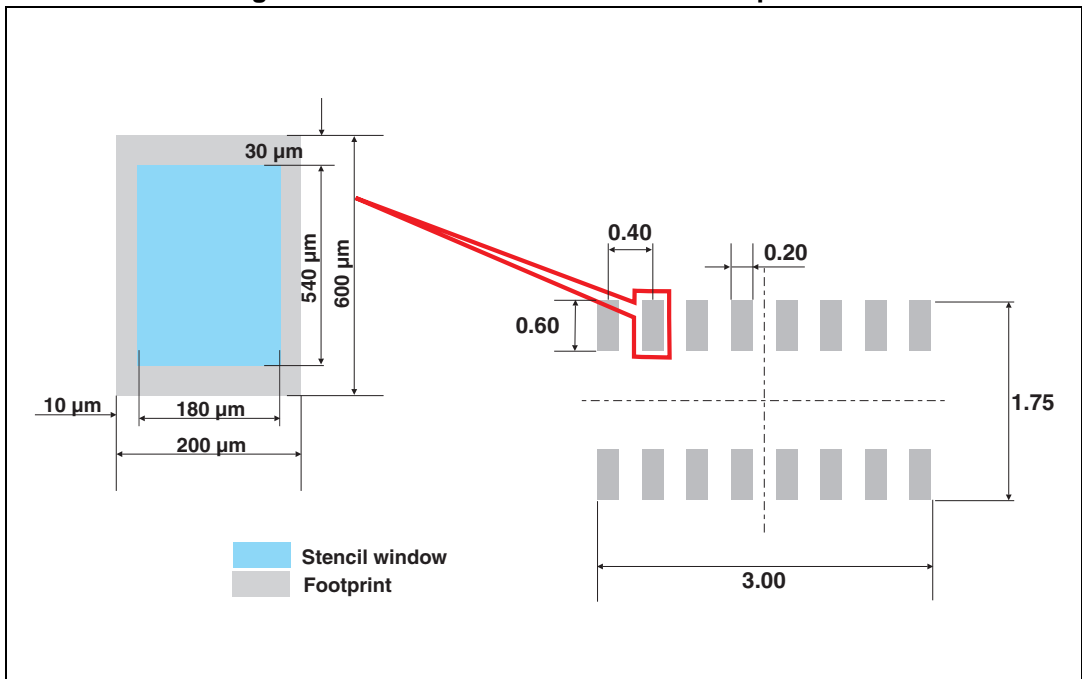

## 4.2 Solder paste

1. Use halide-free flux, qualification ROL0 according to ANSI/J-STD-004.
2. “No clean” solder paste recommended.
3. Offers a high tack force to resist component displacement during PCB movement.
4. Use solder paste with fine particles: powder particle size 20-45  $\mu\text{m}$ .

## 4.3 Placement

1. Manual positioning is not recommended.
2. It is recommended to use the lead recognition capabilities of the placement system, not the outline centering.
3. Standard tolerance of  $\pm 0.05$  mm is recommended.
4. 3.5 N placement force is recommended. Too much placement force can lead to squeezed out solder paste and cause solder joints to short. Too low placement force can lead to insufficient contact between package and solder paste that could cause open solder joints or badly centered packages.
5. To improve the package placement accuracy, a bottom side optical control should be performed with a high resolution tool.
6. For assembly, a perfect supporting of the PCB (all the more on flexible PCB) is recommended during solder paste printing, pick and place and reflow soldering by using optimized tools.

## 4.4 PCB design preference

1. To control the solder paste amount, the closed via is recommended instead of open vias.
2. The position of tracks and open vias in the solder area should be well balanced. The symmetrical layout is recommended, in case any tilt phenomena caused by asymmetrical solder paste amount due to the solder flow away.

## 4.5 Reflow profile

Figure 21. ST ECOPACK<sup>®</sup> recommended soldering reflow profile for PCB mounting

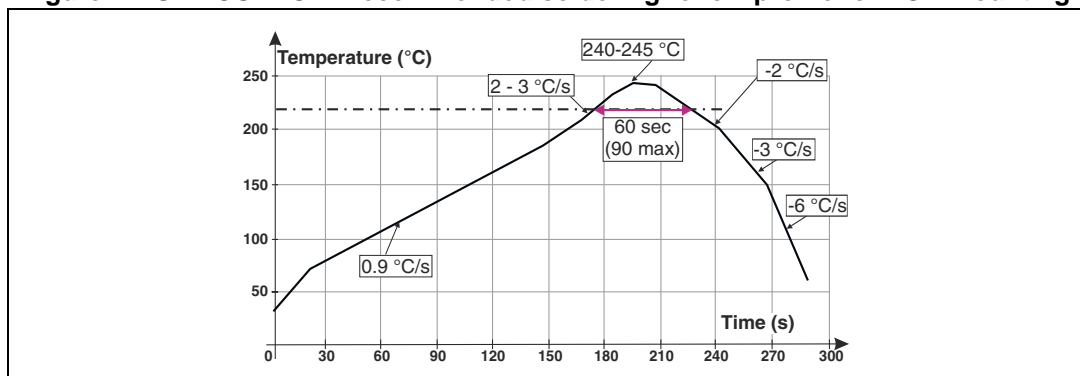

Note: Minimize air convection currents in the reflow oven to avoid component movement.

## 5 Ordering information

Figure 22. Ordering information scheme

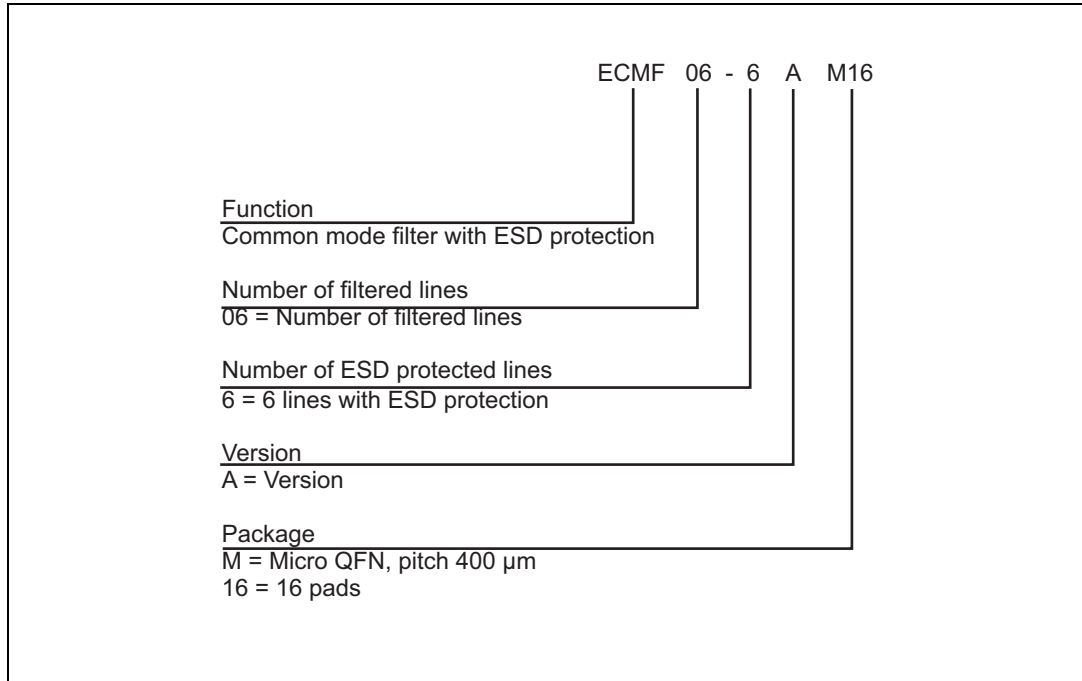

Table 5. Ordering information

Order code	Marking	Package	Weight	Base qty	Delivery mode
ECMF06-6AM16	KF	Micro QFN-16L	6.3 mg	3000	Tape and reel

For the latest information on available order codes see the product pages on [www.st.com](http://www.st.com).

## 6 Revision history

Table 6. Document revision history

Date	Revision	Changes
14-Feb-2012	1	Initial release.
04-Oct-2012	2	Inserted <a href="#">Table 3</a> and updated <a href="#">Figure 1</a> to add A1 marker.
26-may-2014	3	Updated <a href="#">Figure 21</a> , <a href="#">Figure 22</a> , <a href="#">Figure 22</a> and document reformatted.

**Please Read Carefully:**

Information in this document is provided solely in connection with ST products. STMicroelectronics NV and its subsidiaries ("ST") reserve the right to make changes, corrections, modifications or improvements, to this document, and the products and services described herein at any time, without notice.

All ST products are sold pursuant to ST's terms and conditions of sale.

Purchasers are solely responsible for the choice, selection and use of the ST products and services described herein, and ST assumes no liability whatsoever relating to the choice, selection or use of the ST products and services described herein.

No license, express or implied, by estoppel or otherwise, to any intellectual property rights is granted under this document. If any part of this document refers to any third party products or services it shall not be deemed a license grant by ST for the use of such third party products or services, or any intellectual property contained therein or considered as a warranty covering the use in any manner whatsoever of such third party products or services or any intellectual property contained therein.

**UNLESS OTHERWISE SET FORTH IN ST'S TERMS AND CONDITIONS OF SALE ST DISCLAIMS ANY EXPRESS OR IMPLIED WARRANTY WITH RESPECT TO THE USE AND/OR SALE OF ST PRODUCTS INCLUDING WITHOUT LIMITATION IMPLIED WARRANTIES OF MERCHANTABILITY, FITNESS FOR A PARTICULAR PURPOSE (AND THEIR EQUIVALENTS UNDER THE LAWS OF ANY JURISDICTION), OR INFRINGEMENT OF ANY PATENT, COPYRIGHT OR OTHER INTELLECTUAL PROPERTY RIGHT.**

**ST PRODUCTS ARE NOT DESIGNED OR AUTHORIZED FOR USE IN: (A) SAFETY CRITICAL APPLICATIONS SUCH AS LIFE SUPPORTING, ACTIVE IMPLANTED DEVICES OR SYSTEMS WITH PRODUCT FUNCTIONAL SAFETY REQUIREMENTS; (B) AERONAUTIC APPLICATIONS; (C) AUTOMOTIVE APPLICATIONS OR ENVIRONMENTS, AND/OR (D) AEROSPACE APPLICATIONS OR ENVIRONMENTS. WHERE ST PRODUCTS ARE NOT DESIGNED FOR SUCH USE, THE PURCHASER SHALL USE PRODUCTS AT PURCHASER'S SOLE RISK, EVEN IF ST HAS BEEN INFORMED IN WRITING OF SUCH USAGE, UNLESS A PRODUCT IS EXPRESSLY DESIGNATED BY ST AS BEING INTENDED FOR "AUTOMOTIVE, AUTOMOTIVE SAFETY OR MEDICAL" INDUSTRY DOMAINS ACCORDING TO ST PRODUCT DESIGN SPECIFICATIONS. PRODUCTS FORMALLY ESCC, QML OR JAN QUALIFIED ARE DEEMED SUITABLE FOR USE IN AEROSPACE BY THE CORRESPONDING GOVERNMENTAL AGENCY.**

Resale of ST products with provisions different from the statements and/or technical features set forth in this document shall immediately void any warranty granted by ST for the ST product or service described herein and shall not create or extend in any manner whatsoever, any liability of ST.

ST and the ST logo are trademarks or registered trademarks of ST in various countries.

Information in this document supersedes and replaces all information previously supplied.

The ST logo is a registered trademark of STMicroelectronics. All other names are the property of their respective owners.

© 2014 STMicroelectronics - All rights reserved

STMicroelectronics group of companies

Australia - Belgium - Brazil - Canada - China - Czech Republic - Finland - France - Germany - Hong Kong - India - Israel - Italy - Japan - Malaysia - Malta - Morocco - Philippines - Singapore - Spain - Sweden - Switzerland - United Kingdom - United States of America

[www.st.com](http://www.st.com)

