

ACURN101-HF Thru. ACURN105-HF

Forward current: 1.0A

Reverse voltage: 200 to 1000V

RoHS Device
Halogen Free

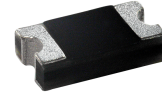

Features

- GPRC(Glass passivated rectifier chip) inside.
- Glass passivated cavity-free junction.
- Low power loss, High efficiency.
- High current capability
- Plastic package has underwriters laboratory flammability classification 94V-0.
- Comply with AEC-Q101

Mechanical Data

- Case: Packed with FRP substrate and epoxy underfilled.
- Terminals: Pure Tin plated (Lead-Free),solderable per MIL-STD-750, method 2026.
- Polarity: Laser cathode band marking.
- Weight: 0.012 grams (approx).

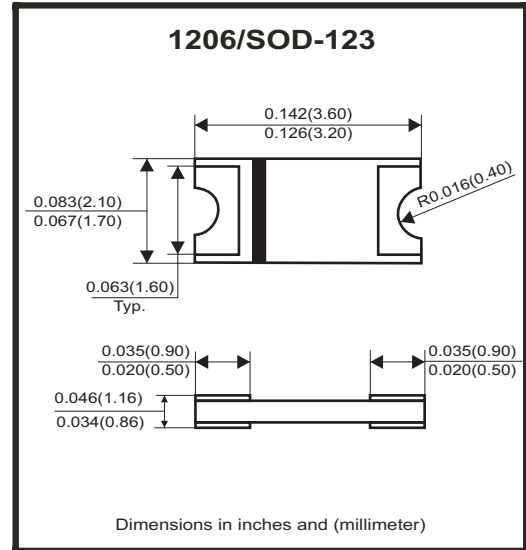

Circuit Diagram



Absolute Maximum Ratings (at TA=25°C unless otherwise noted)

Parameter	Conditions	Symbol	ACURN 101-HF	ACURN 102-HF	ACURN 103-HF	ACURN 104-HF	ACURN 105-HF	Units
Repetitive peak reverse voltage		V_{RRM}	200	400	600	800	1000	V
Average forward current		$I_{F(AV)}$	1.0					A
Peak forward surge current	8.3ms single half sine-wave	I_{FSM}	30			25		A
Reverse recovery time	$I_F=0.5A, I_R=1.0A, I_{rr}=0.25A$	T_{rr}	50			75		nS
Operating junction temperature		T_J	-65 to +175					°C
Storage temperature		T_{STG}	-65 to +175					°C

Electrical Characteristics (at TA=25°C unless otherwise noted)

Parameter	Conditions	Symbol	MIN.	TYP.	MAX.	Unit
Forward voltage	$I_F=0.1A$	V_F	-	0.98	-	V
	$I_F=0.5A$		-	1.28	-	
	$I_F=1.0A$		-	1.45	1.70	
Repetitive peak reverse current	$V_R = \text{Max. } V_{RRM}, T_A=25^\circ\text{C}$	I_{RRM}	-	0.08	5	uA
Junction capacitance	$V_R=4V, f=1.0\text{MHz}$	C_J	-	10	-	pF
Thermal Resistance	Junction to ambient (Note)	$R_{\theta JA}$	-	90	-	°C/W
	Junction to lead (Note)	$R_{\theta JL}$	-	40	-	

Notes: 1. Thermal resistance from junction to ambient and from junction to lead P.C.B. mounted on 0.2×0.2"(5.0*5.0mm) copper pad areas.

Company reserves the right to improve product design , functions and reliability without notice.

REV:A

RATING AND CHARACTERISTIC CURVES (ACURN101-HF Thru. ACURN105-HF)

Fig.1- Forward current derating curve

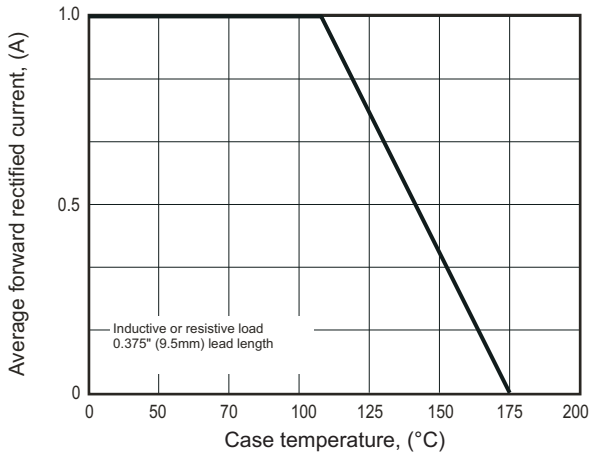

Fig.2- Maximum non-repetitive peak forward surge current

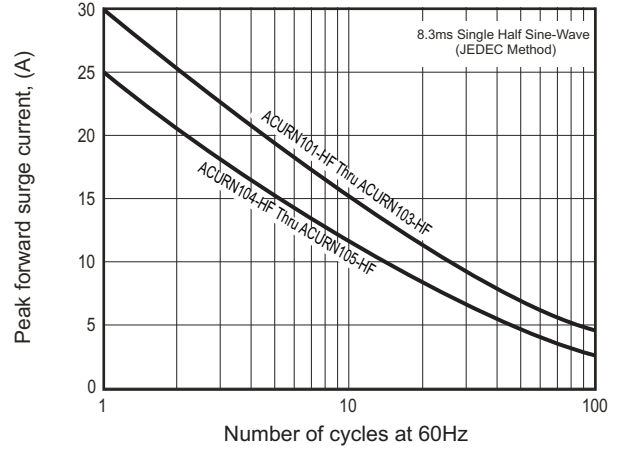

Fig.3- Typical instantaneous forward characteristics

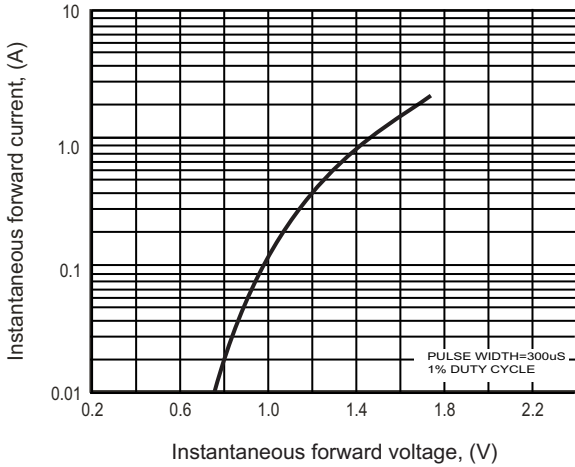

Fig.4- Typical reverse characteristics

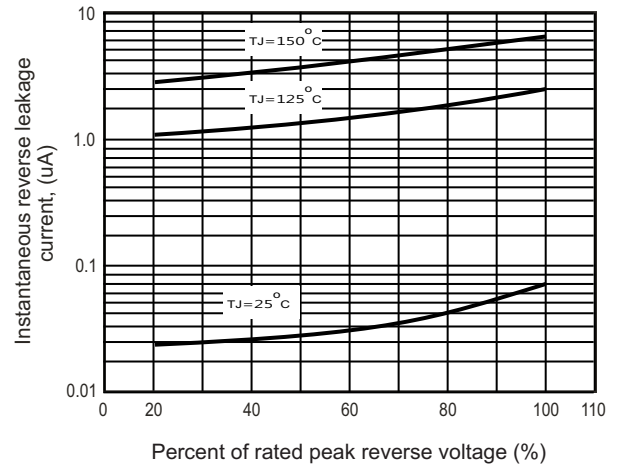
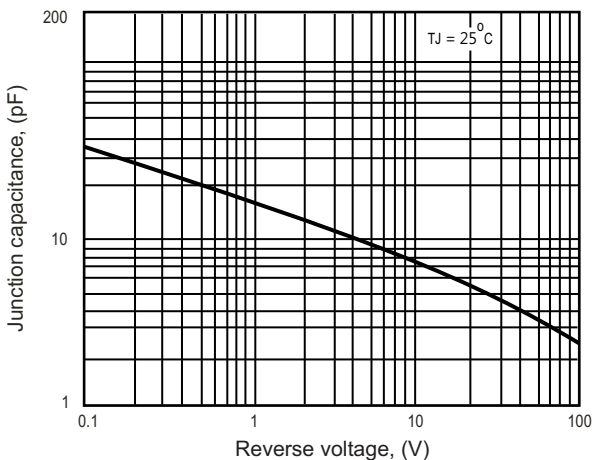
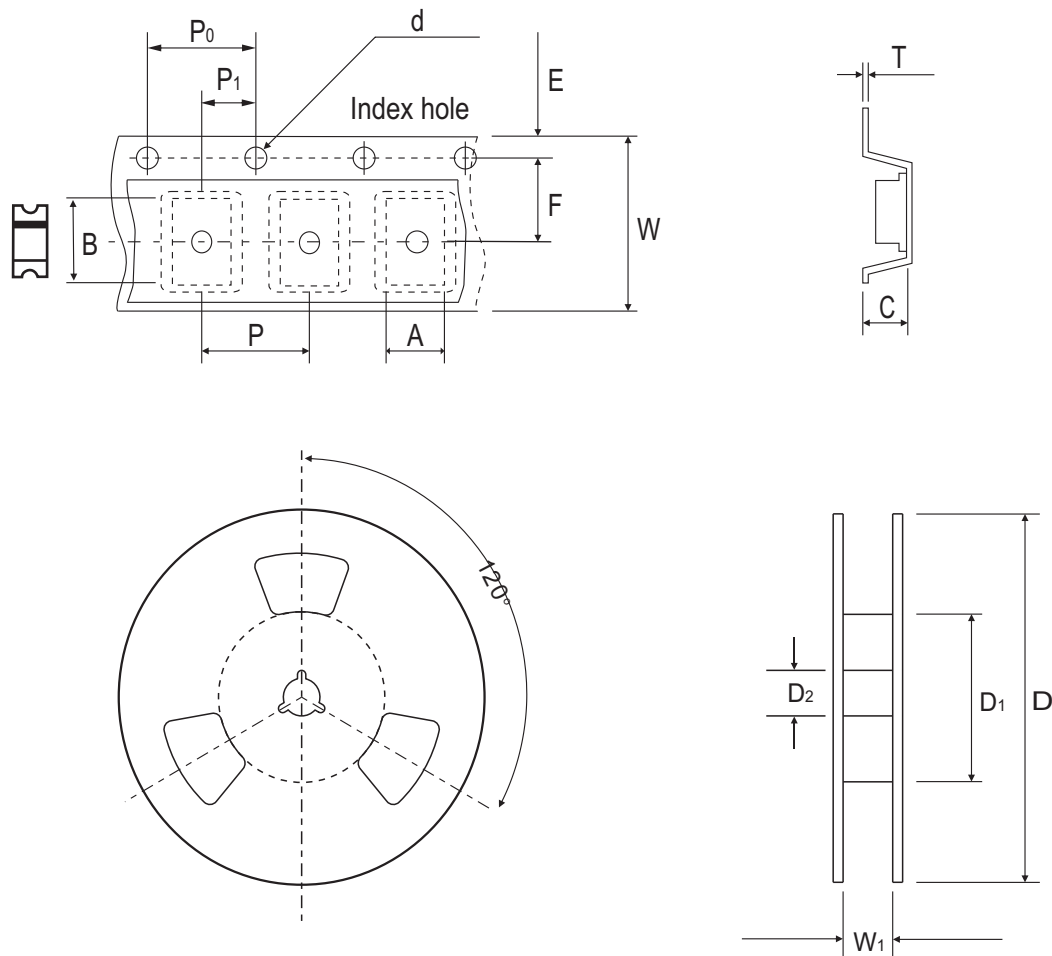

Fig.5 - Typical junction capacitance



Reel Taping Specification



1206 (SOD-123)	SYMBOL	A	B	C	d	D	D ₁	D ₂
	(mm)	2.20 ± 0.10	3.65 ± 0.10	1.28 ± 0.10	1.50 ± 0.10	178 ± 2.00	50.0 MIN.	13.0 ± 0.50
	(inch)	0.087 ± 0.004	0.144 ± 0.004	0.050 ± 0.004	0.059 ± 0.004	7.008 ± 0.079	1.969 MIN.	0.512 ± 0.020

1206 (SOD-123)	SYMBOL	E	F	P	P ₀	P ₁	W	W ₁
	(mm)	1.75 ± 0.10	5.50 ± 0.05	4.00 ± 0.10	4.00 ± 0.10	2.00 ± 0.10	12.00 ± 0.30	14.4 MAX.
	(inch)	0.069 ± 0.004	0.217 ± 0.002	0.157 ± 0.004	0.157 ± 0.004	0.079 ± 0.004	0.472 ± 0.012	0.567 MAX.

Company reserves the right to improve product design , functions and reliability without notice.

REV:A

Marking Code

Part Number	Marking Code
ACURN101HF	ZD
ACURN102-HF	ZG
ACURN103-HF	ZJ
ACURN104-HF	ZK
ACURN105-HF	ZM

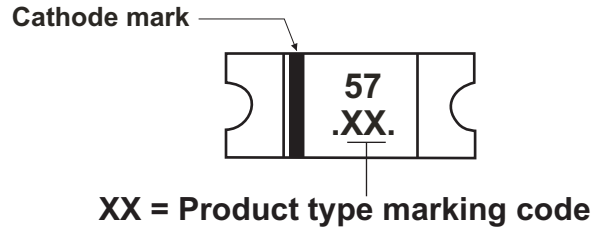

Suggested PAD Layout

SIZE	1206/SOD-123	
	(mm)	(inch)
A	1.50MIN.	0.059MIN.
B	1.00	0.039
C	2.00MAX.	0.079MAX.
D	4.00REF.	0.157REF.

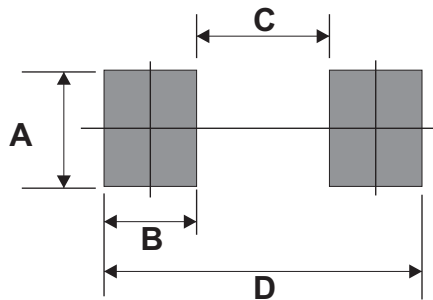

Standard Packaging

Case Type	REEL PACK	
	REEL (pcs)	Reel Size (inch)
1206/SOD-123	3,000	7