

AM2520MBC08

BLUE

Features

- SUBMINIATURE PACKAGE.
- WIDE VIEWING ANGLE.
- YOKE LEAD.
- LONG LIFE - SOLID STATE RELIABILITY.
- LOW PACKAGE PROFILE.
- PACKAGE : 1000PCS / REEL.

Description

The Blue source color devices are made with GaN on SiC Light Emitting Diode.
 Static electricity and surge damage the LEDS. It is recommended to use a wrist band or anti-electrostatic glove when handling the LEDs.
 All devices, equipment and machinery must be electrically grounded.

Package Dimensions

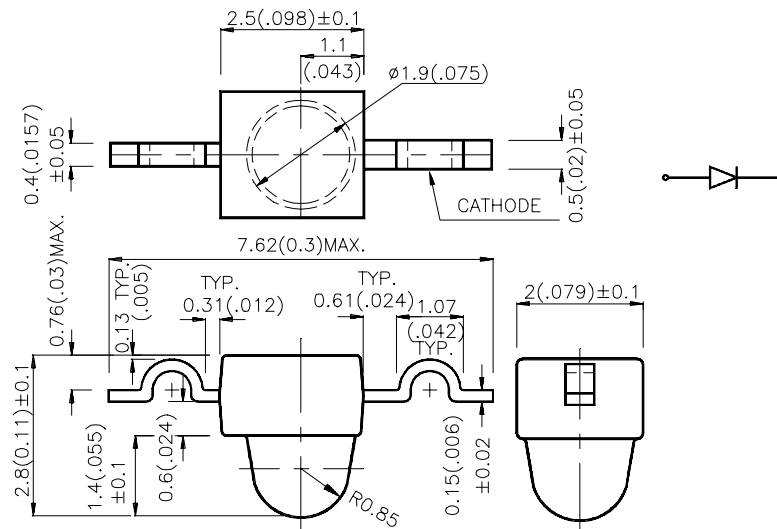

Notes:

1. All dimensions are in millimeters (inches).
2. Tolerance is $\pm 0.25(0.01)$ unless otherwise noted.
3. Lead spacing is measured where the lead emerge package.
4. Specifications are subject to change without notice.

Selection Guide

Part No.	Dice	Lens Type	Iv (mcd) @ 20 mA		Viewing Angle
			Min.	Typ.	θ1/2
AM2520MBC08	BLUE (GaN)	WATER CLEAR	30	60	20°

Note:

1. θ1/2 is the angle from optical centerline where the luminous intensity is 1/2 the optical centerline value.

Electrical / Optical Characteristics at T_A=25°C

Symbol	Parameter	Device	Typ.	Max.	Units	Test Conditions
λ _{peak}	Peak Wavelength	Blue	430		nm	IF=20mA
λ _D	Dominate Wavelength	Blue	455		nm	IF=20mA
Δλ _{1/2}	Spectral Line Halfwidth	Blue	60		nm	IF=20mA
C	Capacitance	Blue	65		pF	VF=0V;f=1MHz
V _F	Forward Voltage	Blue	4.0	4.5	V	IF=20mA
I _R	Reverse Current	Blue		10	μA	VR = 5V

Absolute Maximum Ratings at T_A=25°C

Parameter	Blue	Units
Power dissipation	105	mW
DC Forward Current	30	mA
Peak Forward Current [1]	150	mA
Reverse Voltage	5	V
Operating Temperature	-40°C To +80°C	
Storage Temperature	-40°C To +85°C	

Note:

1. 1/10 Duty Cycle, 0.1ms Pulse Width.

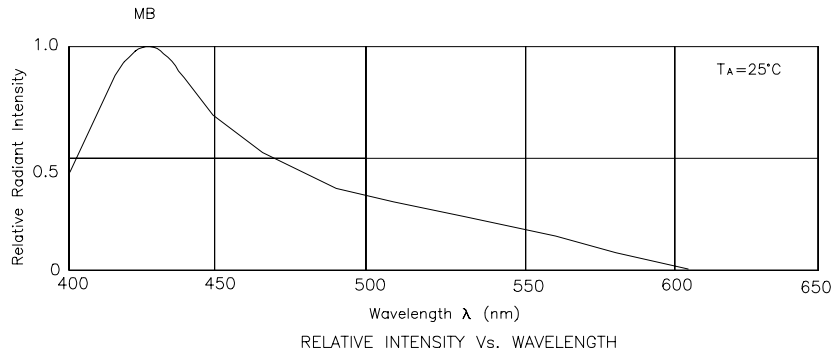

Blue AM2520MBC08

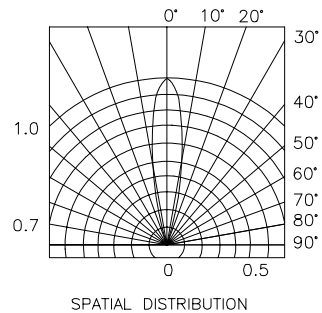
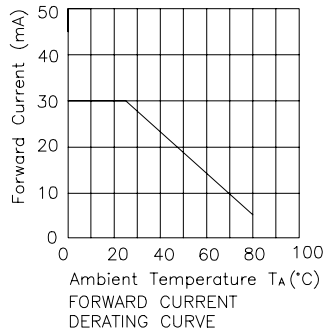
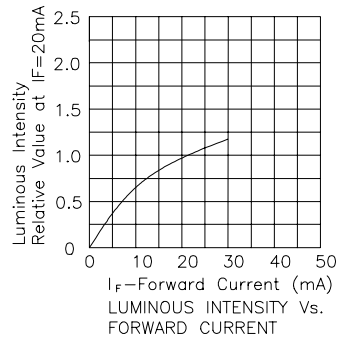
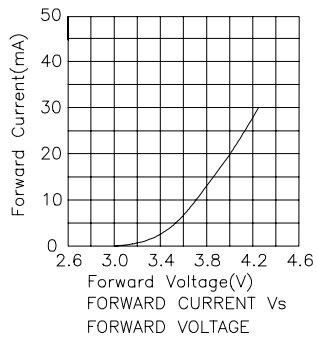

AM2520MBC08 SMT Reflow Soldering Instructions

Number of reflow process shall be less than 2 times and cooling process to normal temperature is required between first and second soldering process.

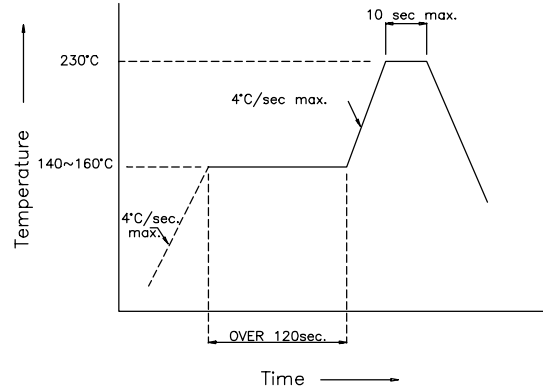

Recommended Soldering Pattern (Units : mm)

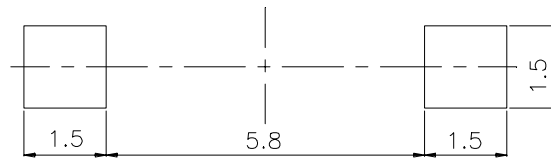

Tape Specifications (Units : mm)

