

Built-in temperature compensation diodes Built-in emitter resistor Darlington

SAP10P

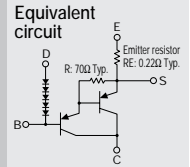

(Complement to type SAP10N)

Application: Audio

Absolute maximum ratings (Ta=25°C)

Symbol	Ratings	Unit
V _{CB0}	-150	V
V _{CEO}	-150	V
V _{EBO}	-5	V
I _C	-12	A
I _B	-1	A
P _C	100(T _C =25°C)	W
D _I I _F	10	mA
T _J	150	°C
T _{stg}	-40 to +150	°C

Electrical Characteristics (Ta=25°C)

Symbol	Conditions	Ratings			Unit
		min	typ	max	
I _{CB0}	V _{CB} = -150V			-100	μA
I _{EBO}	V _{EB} = -5V			-100	μA
V _{CEO}	I _C = -30mA	-150			V
h _{FE} *	V _{CE} = -4V, I _C = -7A	5000		20000	
V _{CE(sat)}	I _C = -7A, I _B = -7mA			-2.0	V
V _{BE(sat)}	I _C = -7A, I _B = -7mA			-2.5	V
V _{BE}	V _{CE} = -20V, I _C = -40mA		1210		mV
D _I V _F	I _F = 2.5mA		1540		mV
R _E	I _E = 1A	0.176	0.22	0.264	Ω

*h_{FE} Rank \bar{O} (5000 to 12000), Y (8000 to 20000)

External Dimensions

(Unit: mm)

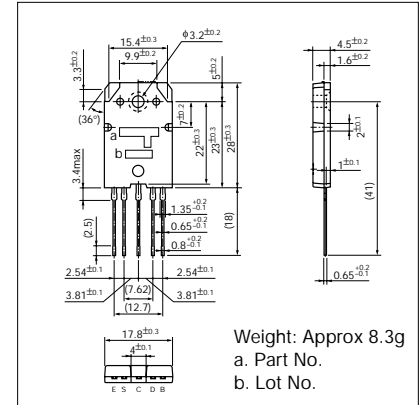

I_C - V_{CE} Characteristics (Typical)

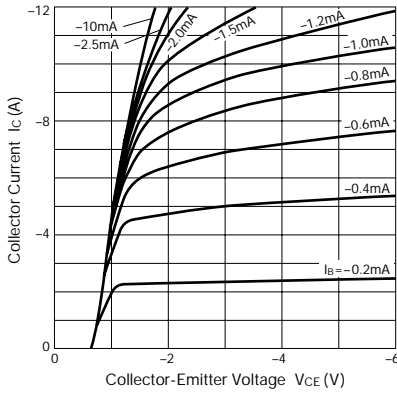

V_{CE(sat)} - I_B Characteristics (Typical)

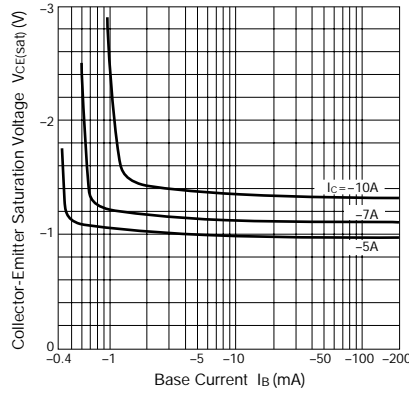

I_C - V_{BE} Temperature Characteristics (Typical)

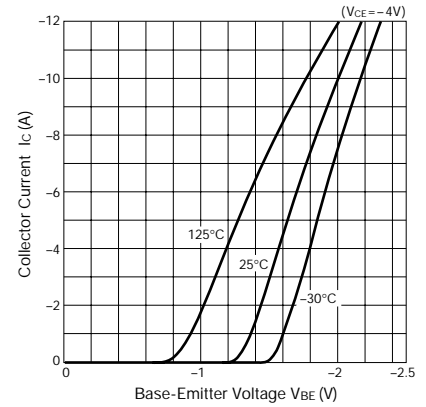

h_{FE} - I_C Characteristics (Typical)

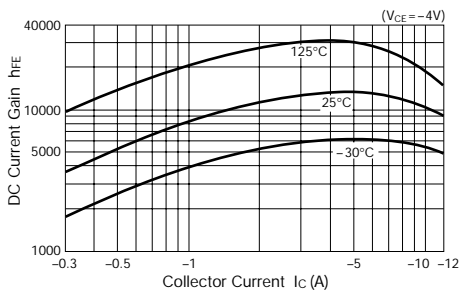

θ_{J-a} - t Characteristics

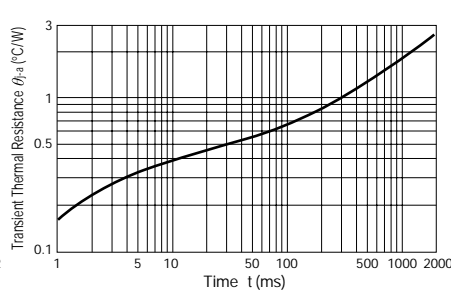

Safe Operating Area (Single Pulse)

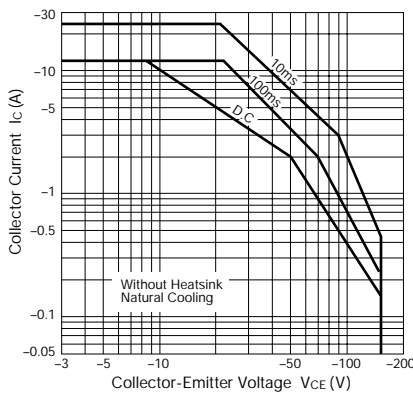

P_C - T_a Derating

