

DIGITRON SEMICONDUCTORS

2N4199 – 2N4204

SILICON CONTROLLED RECTIFIERS

Available Non-RoHS (standard) or RoHS compliant (add PBF suffix).

Available as "HR" (high reliability) screened per MIL-PRF-19500, JANTX level. Add "HR" suffix to base part number.

MAXIMUM RATINGS

Rating	Symbol	Value	Unit
Peak Reverse Blocking Voltage, Note 1 ($T_J = 105^\circ\text{C}$)	V_{RRM}	50	Volts
Peak Forward Blocking Voltage, Note 1 ($T_C = 105^\circ\text{C}$)	V_{DRM}	2N4199 300	Volts
		2N4200 400	
		2N4201 500	
		2N4202 600	
		2N4203 700	
		2N4204 800	
Repetitive Peak On-State Current ($PW = 3 \mu\text{s}$, Duty Cycle = 0.6%, $T_C = 85^\circ\text{C}$)	I_{TRM}	100	Amps
Continuous On-State Current ($T_C = 65^\circ\text{C}$)	I_T	5	Amps
Current Application Rate, Note 2	di/dt	5000	A/ μs
Peak Forward Gate Power	P_{GFM}	20	Watt
Average Forward Gate Power	$P_{GF(AV)}$	1	Watt
Peak Forward Gate Current	I_{GFM}	5	Amps
Peak Gate Voltage – Forward Reverse, Note 3	V_{GFM} V_{GRM}	10 10	Volts
Operating Junction Temperature Range Blocking State Conducting State	T_J	-65 to +105	$^\circ\text{C}$
		-65 to +200	
Storage Temperature Range	T_{stg}	-65 to +200	$^\circ\text{C}$
Stud Torque	-	15	In. lb.
Thermal resistance, junction to case	$R_{\theta JC}$	3	$^\circ\text{C/W}$

Note 1: Characterized for unilateral applications where reverse blocking capability is not important. V_{DRM} and V_{RRM} may be applied as a continuous dc voltage for zero or negative gate voltage but positive gate voltage must not be applied concurrently with a negative potential on the anode. When checking blocking capability, do not permit the applied voltage to exceed the rated voltage.

Note 2: Minimum Gate Trigger Pulse: $I_G = 200 \text{ mA}$, $PW = 1 \mu\text{s}$, $t_r = 20 \text{ ns}$.

Note 3: Do not reverse bias gate during forward conduction if anode current exceeds 10 amperes.

ELECTRICAL CHARACTERISTICS ($T_C = 25^\circ\text{C}$ unless otherwise noted)

Characteristics	Symbol	Min	Max	Unit
Peak Forward or Reverse Blocking Current (Rated V_{DRM} or V_{RRM}, gate open) $T_C = 105^\circ\text{C}$	I_{DRM} , I_{RRM}	-	2	mA
Gate Trigger Current (Continuous dc) (Anode Voltage = 7 Vdc, $R_L = 100 \text{ ohms}$, $T_C = 25^\circ\text{C}$) (Anode Voltage = 7 Vdc, $R_L = 100 \text{ ohms}$, $T_C = -65^\circ\text{C}$)	I_{GT}	-	50	mA
		-	100	
Gate Trigger Voltage (Continuous dc) (Anode Voltage = rated V_{DRM}, $R_L = 100 \text{ ohms}$, $T_C = 105^\circ\text{C}$) (Anode Voltage = 7 Vdc, $R_L = 100 \text{ ohms}$, $T_C = 25^\circ\text{C}$) (Anode Voltage = 7 Vdc, $R_L = 100 \text{ ohms}$, $T_C = -65^\circ\text{C}$)	V_{GT}	0.2	-	Volts
		-	1.5	
		-	2	
Holding Current (Anode Voltage = 7 Vdc, gate open, $T_C = 105^\circ\text{C}$)	I_H	3	-	mA
Forward "on" Voltage ($I_{TM} = 5 \text{ Adc}$, $PW = 1 \text{ ms max}$, Duty Cycle $\leq 1\%$)	V_{TM}	2.6	-	Volts
Dynamic Forward "on" Voltage (0.5 μs after 50% decay point on dynamic forward voltage waveform) Forward Current: 30 A pulse Gate Pulse: at 200 mA, $PW = 1 \mu\text{s}$, $t_r = 20 \text{ ns}$	V_{TM}	-	25	Volts

DIGITRON SEMICONDUCTORS

2N4199 – 2N4204

SILICON CONTROLLED RECTIFIERS

ELECTRICAL CHARACTERISTICS ($T_C = 25^\circ\text{C}$ unless otherwise noted)

Characteristics	Symbol	Min	Max	Unit
Turn-on Time $I_{TM} = 30\text{ A}$				
Delay Time	All Types	-	200	ns
Rise Time	2N4199 & 2N4200	-	200	
	2N4201	-	150	
	2N4202	-	130	
	2N4203 & 2N4204	-	100	
Pulse Turn-off Time				
Test Conditions: PFN discharge; Forward Current = 30 A pulse;				
Reverse Current = 5 A, $T_C = 85^\circ\text{C}$, $dv/dt = 250\text{V}/\mu\text{s}$ to Rated V_{DRM};				
Reverse Anode Voltage during turn-off interval = 0 V;				
Reverse gate bias during turn-off interval = 6 V				
Forward Voltage Application Rate (Linear Rise of Voltage)				
($T_C = 105^\circ$, gate open, $V_D = \text{Rated } V_{DRM}$)	dv/dt	250	-	V/ μs

MECHANICAL CHARACTERISTICS

Case	TO-64
Marking	Alpha-numeric
Pin out	See below

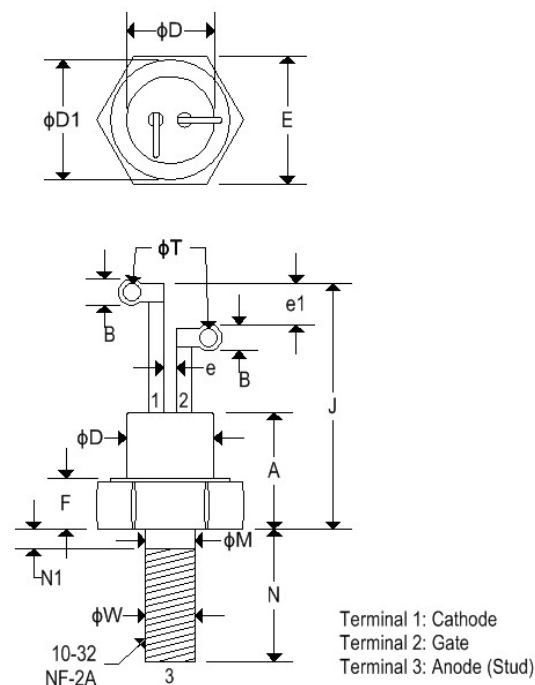

	TO-64			
	Inches		Millimeters	
	Min	Max	Min	Max
A	0.300	0.400	7.620	10.160
B	0.080	0.136	2.030	3.450
ΦD	-	0.424	-	10.770
ΦD_1	0.400	-	10.160	-
E	0.424	0.437	10.770	11.100
e	0.013	-	0.330	-
e ₁	0.060	-	1.520	-
F	0.060	0.175	1.520	4.450
J	0.700	0.855	17.780	21.720
ΦM	0.163	0.189	4.140	4.800
N	0.400	0.453	10.160	11.510
N ₁	-	0.078	-	1.980
ΦT	0.040	0.075	1.020	1.910
ΦW	0.1658	0.1697	4.212	4.310

DIGITRON SEMICONDUCTORS

2N4199 - 2N4204 SILICON CONTROLLED RECTIFIERS

DERATING USING NO SWITCHING LOSSES

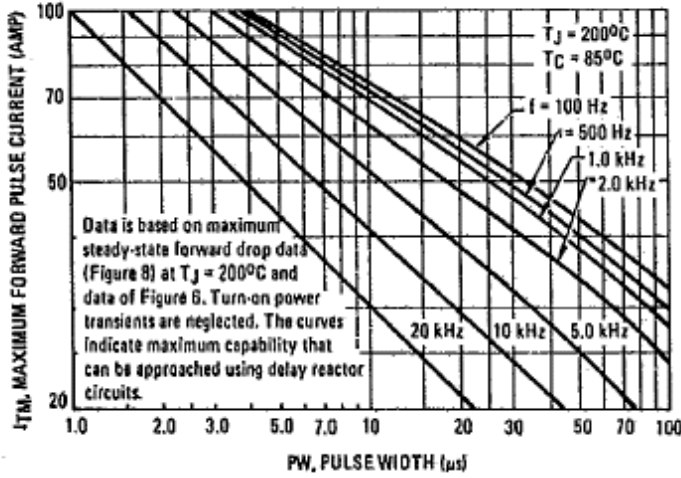

DERATING USING TYPICAL SWITCHING LOSSES

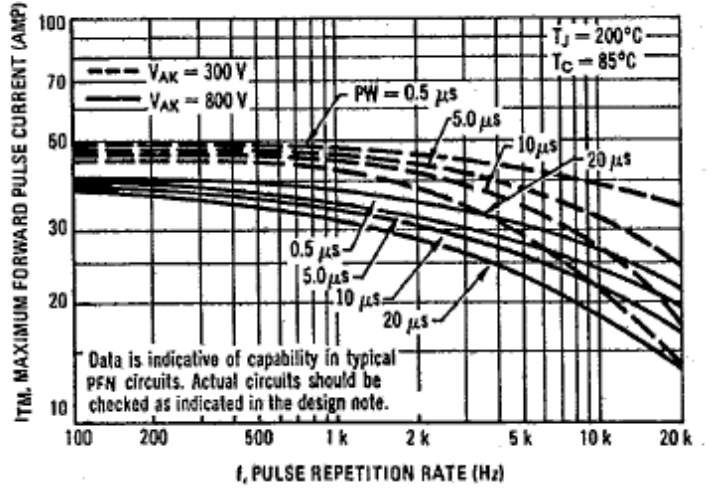

NORMALIZED EFFECTIVE TRANSIENT THERMAL RESISTANCE

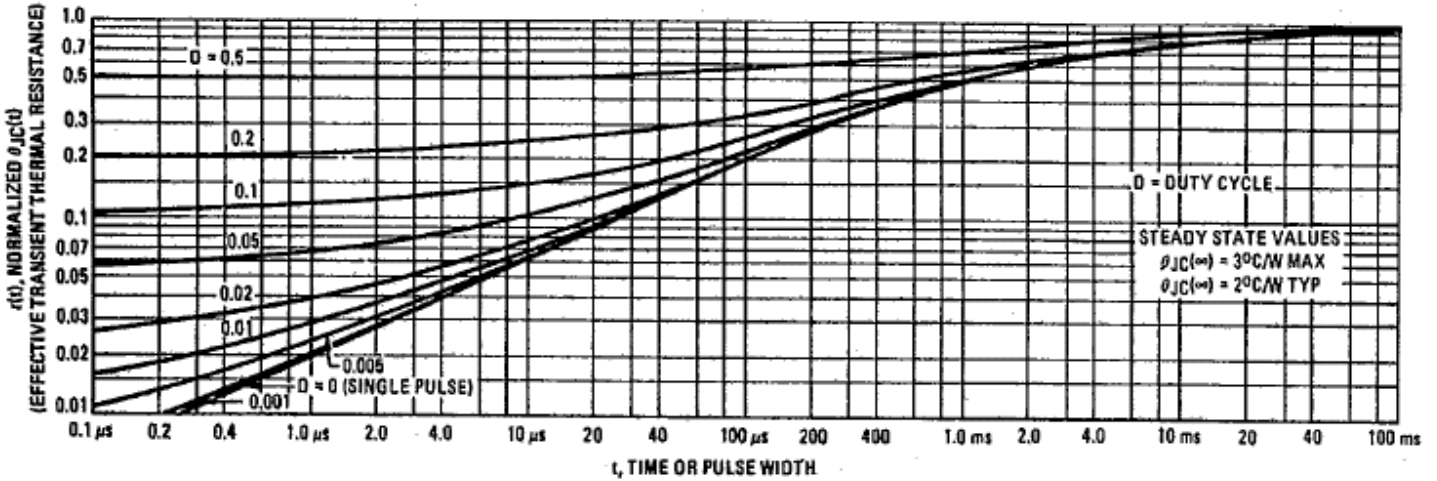

FORWARD "ON" VOLTAGE DATA

TYPICAL DYNAMIC FORWARD "ON" VOLTAGE

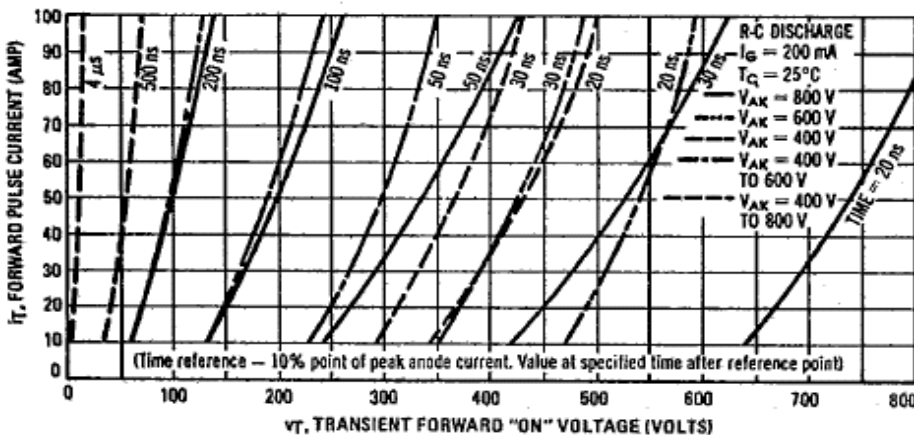

MAXIMUM STEADY-STATE

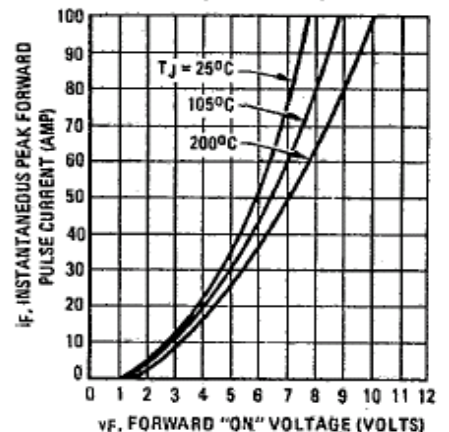

DIGITRON SEMICONDUCTORS

2N4199 - 2N4204

SILICON CONTROLLED RECTIFIERS

SWITCHING CHARACTERISTICS

DELAY TIME

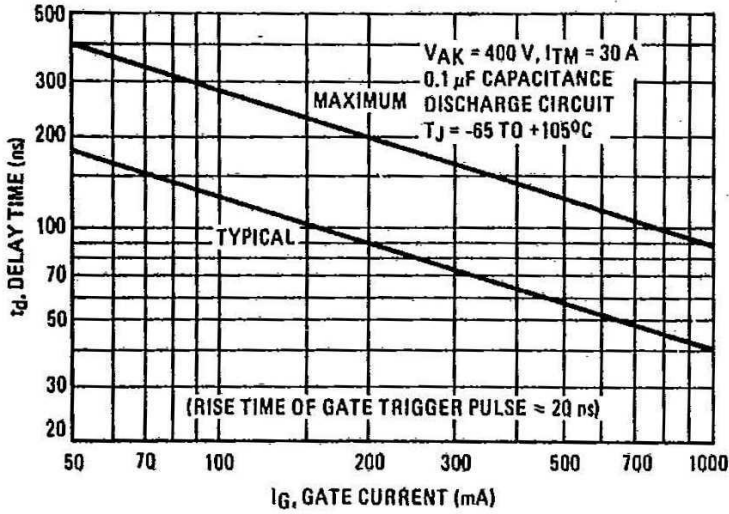

TYPICAL PULSE TRIGGER CHARGE/CURRENT

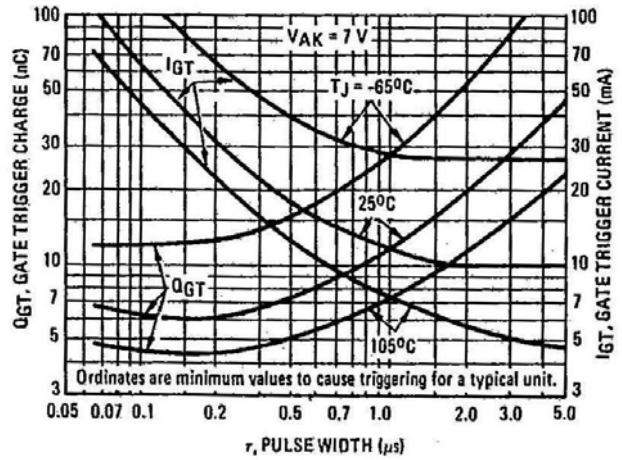

CURRENT RISE TIME

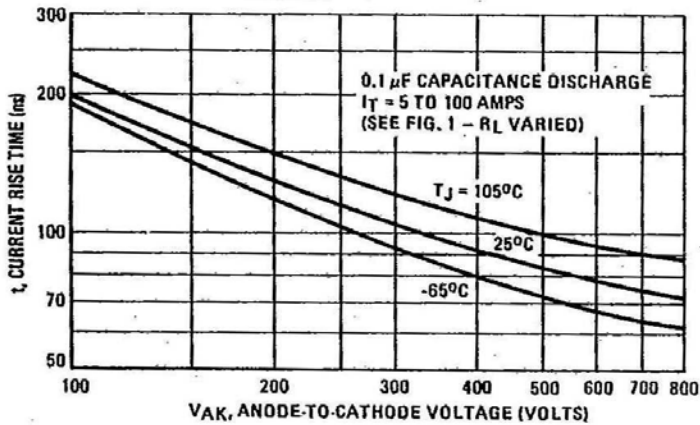

DC GATE TRIGGER VOLTAGE

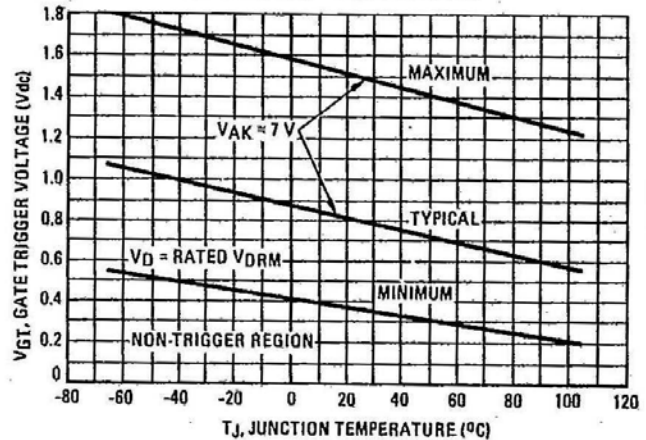

TYPICAL TURN-OFF TIME

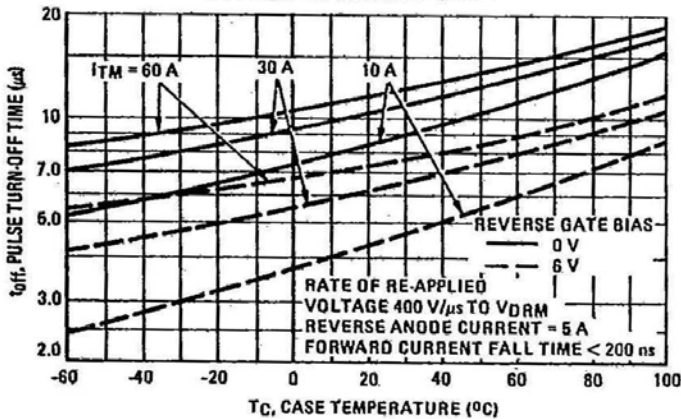

DC GATE TRIGGER CURRENT

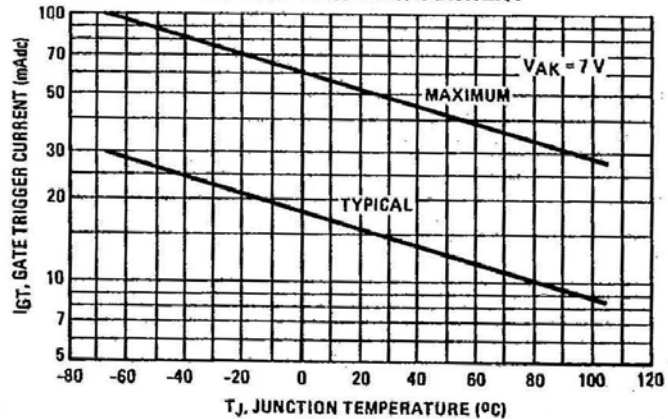

DIGITRON SEMICONDUCTORS

2N4199 - 2N4204

SILICON CONTROLLED RECTIFIERS

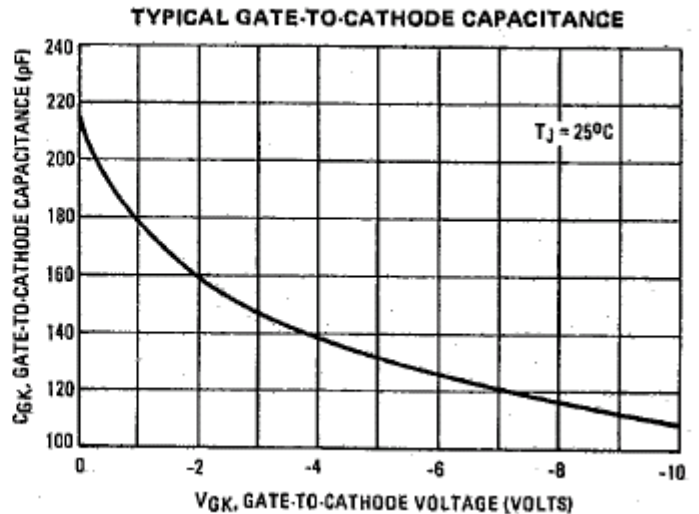
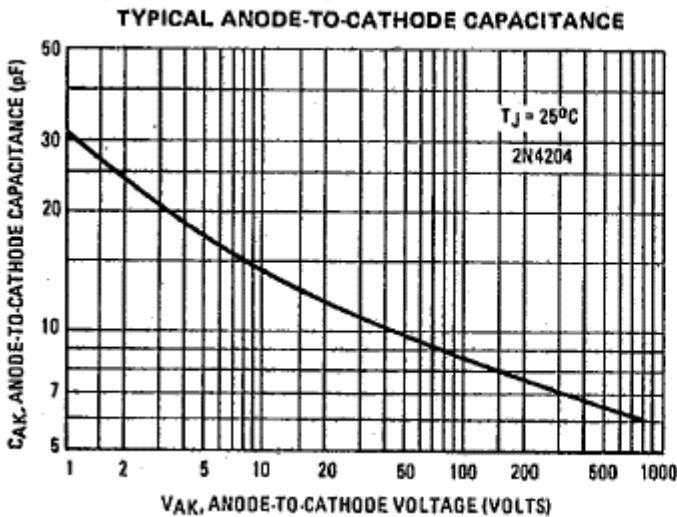
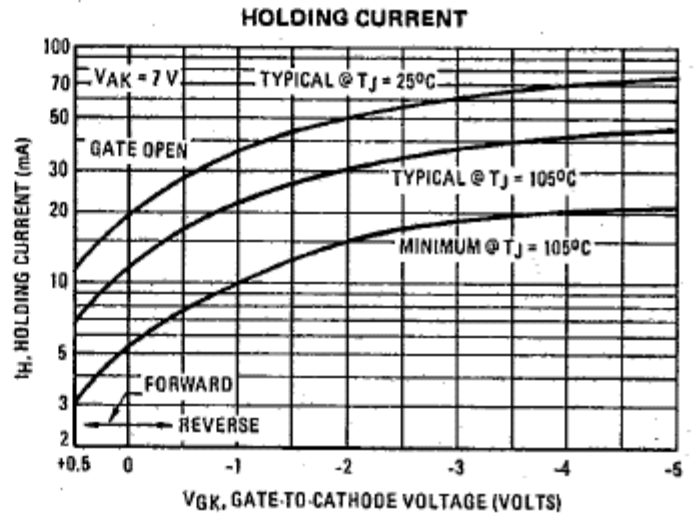
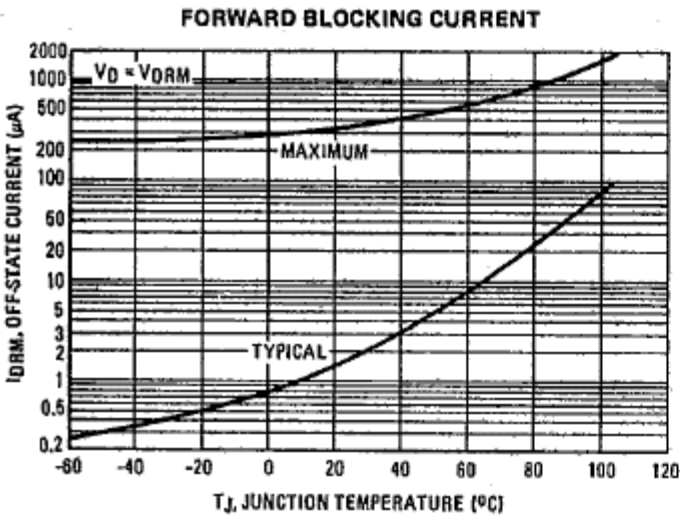
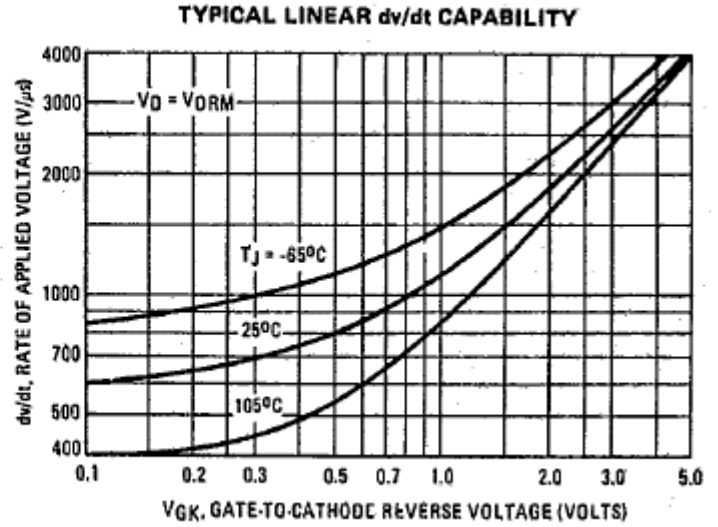
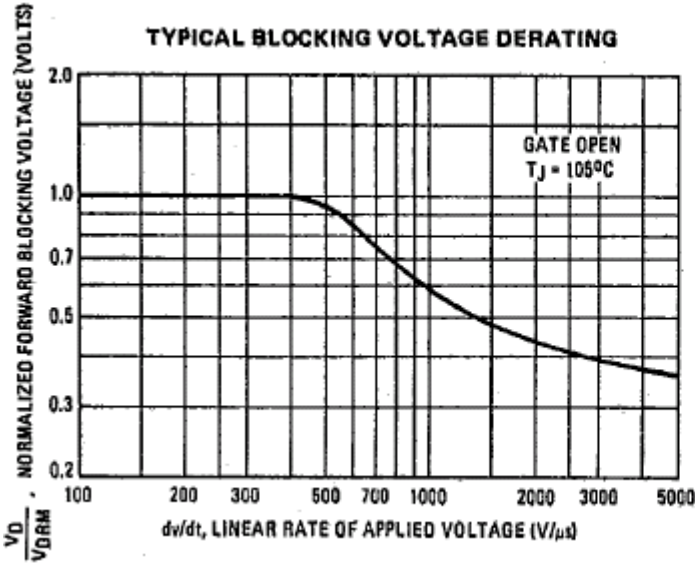

DIGITRON SEMICONDUCTORS

2N4199 - 2N4204

SILICON CONTROLLED RECTIFIERS

TURN-ON TIME

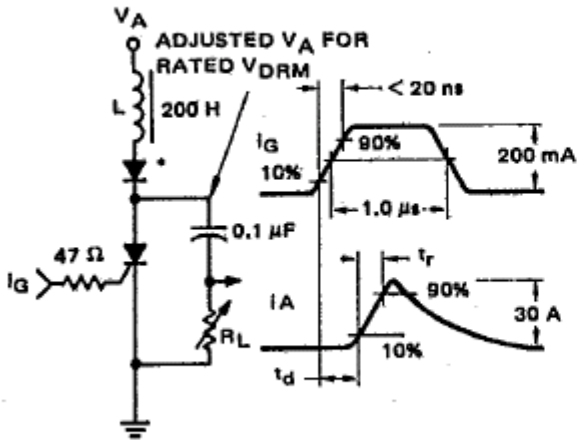

TURN-OFF TIME

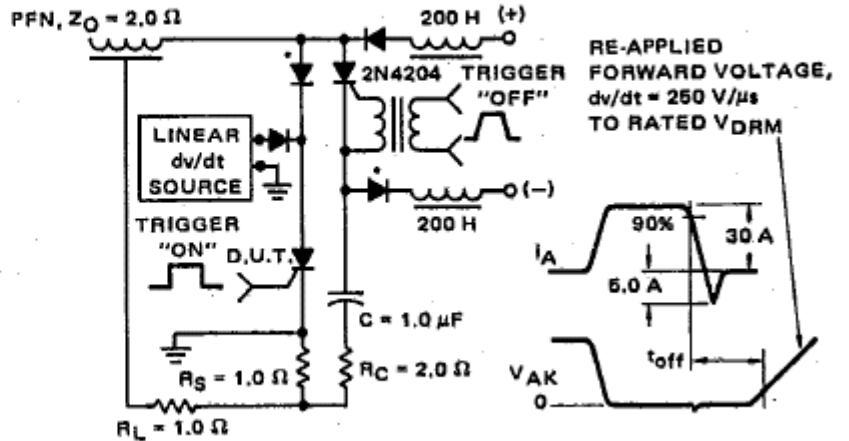

MAXIMUM ALLOWABLE FORWARD PULSE CURRENT

