

Meets automotive needs with a sealed contact structure for dust resistance

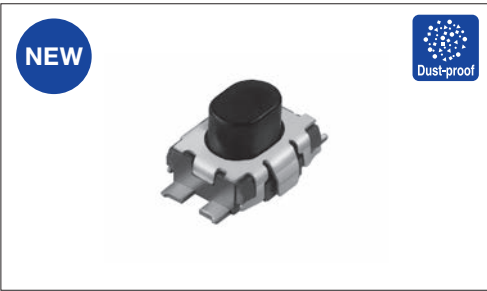

■ Typical Specifications

| Items | Specifications |
|----------------------------|----------------|
| Rating (max.) | 25mA 16V DC |
| Rating (min.) | 10μA 1V DC |
| Initial contact resistance | 500mΩ max. |
| Travel (mm) | 0.12 |

■ Product Line

| Product No. | Operating force | Operating direction | Operating life (5mA 5V DC) | Stem height | Minimum order unit (pcs.) | | Drawing No. |
|-------------------|-----------------|---------------------|----------------------------|-------------|---------------------------|--------|-------------|
| | | | | | Japan | Export | |
| SKTHBAE010 | 3N | Top push | 200,000 cycles | 2.5mm | 4,000 | 4,000 | 1 |
| SKTHACE010 | 1.4N | | 100,000 cycles | 1.8mm | 5,000 | 5,000 | 2 |

■ Packing Specifications

Taping

| Series | Number of packages (pcs.) | | | Tape width (mm) | Export package measurements (mm) |
|---------------|---------------------------|---------------|-------------------------|-----------------|----------------------------------|
| | 1 reel | 1 case /Japan | 1 case / export packing | | |
| SKTHBA | 4,000 | 40,000 | 40,000 | 12 | 401×401×214 |
| SKTHAC | 5,000 | 50,000 | 50,000 | | |

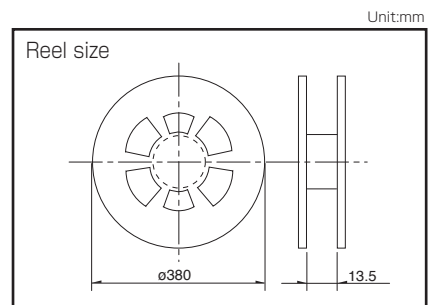

Note

For reels of 330mm diameter, please inquire.

■ Dimensions

| No. | Style | PC board mounting hole and land dimensions (Viewed from switch mounting face) |
|-----|-------|---|
| 1 | | |

Refer to P.259 for soldering conditions.

SKTH 3.5 × 3.2mm Compact Dust Proof (Surface Mount Type)

TACT Switch™

Sharp Feeling

Soft Feeling

Snap-In Type

Surface Mount Type

Radial Type

■ Dimensions

Unit:mm

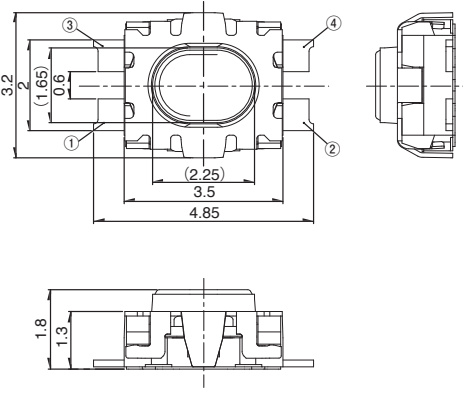
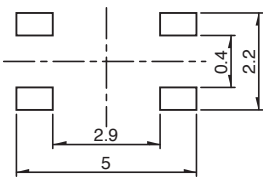



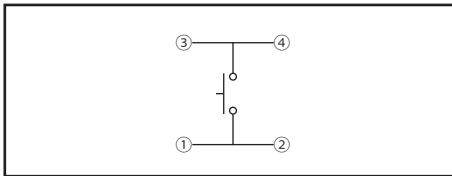











| No. | Style | PC board mounting hole and land dimensions (Viewed from switch mounting face) |
|-----|---|---|
| 2 |  |  |

■ Circuit Diagram



TACT Switch™

List of Varieties

| Type | | Sharp Feeling Type | | | | | | | | |
|-----------------------------|--------------------------------|---|---|---|---|---|---|---|---|----------------|
| | | Surface Mount | | | | | | | | |
| Series | | SKTH | SKRP | SKQM | SKQY | SKSU | SKST | SKRA | SKHM | |
| Photo | |  |  |  |  |  |  |  |  | |
| Features | | Compact size | High operation force Compact size | Compact size | | Middle travel | | | — | |
| Water-proof | | — | — | — | — | ● | — | ○ | — | |
| Dust-proof | | ● | — | — | — | ● | — | ○ | — | |
| IP standard | | — | — | — | — | 67 equivalency | — | 67 equivalency | — | |
| Operating direction | Top push | ● | ● | ● | ● | ● | ● | ● | ● | |
| | Side push | — | — | — | — | — | — | — | — | |
| Dimensions (mm) | W | 3.5 | 4.2 | 6 | 6.1 | 5.3 | 8.5 | □6.2 | 6.2 | |
| | D | 3.2 | 3.2 | 3.5 | 3.7 | 5.4 | 8.5 | | 6.5 | |
| | H | 1.8/2.5 | 2.5 | 4.3/5 | 2.5 | 3.85 | 3.95 | 3.5/5.2 | 3.1 | |
| Operation force coverage | to 1N | ↕ | ↕ | ↕ | ↕ | ↕ | ↕ | ↕ | ↕ | |
| | 1N to 2N | | | | | | | | | |
| | 2N to 3N | | | | | | | | | |
| | 3N to 4N | | | | | | | | | |
| 4N to 5N | ↕ | ↕ | ↕ | ↕ | ↕ | ↕ | ↕ | ↕ | | |
| Travel (mm) | | 0.12 | 0.2 | 0.25 | | 0.7 | 0.9 | See the relevant pages for respective product descriptions | 0.25 | |
| Ground terminal | | — | — | — | ○ | — | — | — | ● | |
| Operating temperature range | | -40°C to +90°C | | | | | | | | -40°C to +85°C |
| Automotive use | | ● | ● | ● | ● | ● | ● | ○ | — | |
| Life Cycle | |  |  |  |  |  |  |  |  | |
| Electrical performance | Rating (max.) (Resistive load) | 25mA 16V DC | 50mA 16V DC | 50mA 12V DC | | 50mA 16V DC | | 50mA 12V DC | | |
| | Rating (min.) (Resistive load) | 10μA 1V DC | | | | | | | | |
| | Insulation resistance | 100MΩ min. 100V DC 1min. | | | | | | | | |
| | Voltage proof | 100V AC 1min. | 250V AC 1min. | | | | | | | |
| Durability | Vibration | 0 to 55 to 10Hz/min., the amplitude is 1.5mm for all the frequencies, in the 3 direction of X, Y and Z for 2 hours respectively | | | | | | | | |
| | Lifetime | Shall be in accordance with individual specifications. | | | | | | | | |
| Environmental performance | Cold | -40°C 96h | -40°C 1,000h | -40°C 96h | | -40°C 1,000h | | -40°C 96h | | |
| | Dry heat | 90°C 96h | 90°C 1,000h | 90°C 96h | | 90°C 1,000h | | 90°C 96h | | |
| | Damp heat | 60°C, 90 to 95%RH 96h | 60°C, 90 to 95%RH 1,000h | 60°C, 90 to 95%RH 96h | | 60°C, 90 to 95%RH 1,000h | | 60°C, 90 to 95%RH 96h | | |
| Page | | 227 | 229 | 230 | 231 | 233 | 234 | 235 | 236 | |

W : Width. The most outer dimension excluding terminal portion.
D : Depth. The most outer dimension excluding terminal portion.
H : Height. The minimum dimension if there are variances.

TACT Switch™ Soldering Conditions 259
TACT Switch™ Cautions 260

Notes

- The automotive operating temperature range to be individually discussed upon request.
- Indicates applicability to all products in the series, while ○ indicates applicability to some products in the series.

Condition for Reflow

Available for Surface Mount Type.

1. Temperature measurement: Thermocouple ϕ 0.1 to 0.2 CA (K) or CC (T) at solder joints (copper foil surface).
A heat resistive tape should be used to fix thermocouple.
2. Temperature profile

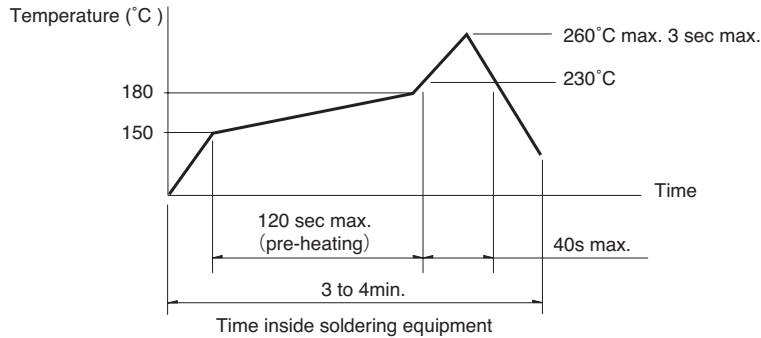

Notes

1. The above temperature shall be measured of the top of switch. There are cases where the PC board's temperature greatly differs from that of the switch, depending on the material, size, thickness of PC boards and others.
The above-stated conditions shall also apply to switch surface temperatures.
2. Soldering conditions differ depending on reflow soldering machines.
Prior verification of soldering condition is highly recommended.

Conditions for Auto-dip

Available for Snap-in Type and Radial Type.

| Items | Condition |
|------------------------|---|
| Flux built-up | Mounting surface should not be exposed to flux |
| Preheating temperature | Ambient temperature of the soldered surface of PC board. 100°C max. |
| Preheating time | 60s max. |
| Soldering temperature | 260°C max. |
| Duration of immersion | 5s max. |
| Number of soldering | 2times max. |

SKHH, SKPD Series

| Items | Condition |
|------------------------|---|
| Flux built-up | Mounting surface should not be exposed to flux |
| Preheating temperature | Ambient temperature of the soldered surface of PC board. 110°C max. |
| Preheating time | 60s max. |
| Soldering temperature | 260°C max. |
| Duration of immersion | 5s max. |
| Number of soldering | 2times max. |

SKQJ, SKQK, SKEG Series

| Items | Condition |
|------------------------|---|
| Flux built-up | Mounting surface should not be exposed to flux |
| Preheating temperature | Ambient temperature of the soldered surface of PC board. 100°C max. |
| Preheating time | 45s max. |
| Soldering temperature | 255°C max. |
| Duration of immersion | 5s max. |
| Number of soldering | 2times max. |

Manual Soldering

| Items | Condition |
|----------------------------|------------|
| Soldering temperature | 350°C max. |
| Duration of soldering | 3s max. |
| Capacity of soldering iron | 60W max. |

SKHH, SKHW, SKRG, SKPD Series

| Items | Condition |
|----------------------------|------------|
| Soldering temperature | 360°C max. |
| Duration of soldering | 3s max. |
| Capacity of soldering iron | 60W max. |

SKTD, SKTG, SKQJ, SKQK, SKEG Series

| Items | Condition |
|----------------------------|------------|
| Soldering temperature | 350°C max. |
| Duration of soldering | 3s max. |
| Capacity of soldering iron | 20W max. |

Notes

1. Prevent flux penetration from the top side of the TACT Switch™.
2. Switch terminals and a PC board should not be coated with flux prior to soldering.
3. The second soldering should be done after the switch is stable with normal temperature.
4. Use the flux with a specific gravity of min 0.81.
(EC-19S-8 by TAMURA Corporation, or equivalents.)