

## Description

The 74LV32A provides provides four independent 2-input OR gates with standard push-pull outputs. The device is designed for operation with a power supply range of 2.0V to 5.5V.

The inputs are tolerant to 5.5V allowing this device to be used in a mixed voltage environment. The device is fully specified for partial power down applications using I<sub>OFF</sub>. The I<sub>OFF</sub> circuitry disables the output preventing damaging current backflow when the device is powered down.

The gates perform the Boolean function:

$$Y = A + B \text{ or } Y = \overline{\overline{A} \cdot \overline{B}}$$

## Features

- Wide Supply Voltage Range from 2.0V to 5.5V
- Sinks or sources 12mA at V<sub>CC</sub> = 4.5V
- CMOS low power consumption
- I<sub>OFF</sub> Supports Partial -Power Down Operation
- Inputs or Outputs accept up to 5.5V
- Inputs can be driven by 3.3V or 5V allowing for voltage translation applications.
- Schmitt Trigger Action at All Inputs
- ESD Protection Tested per JESD 22
  - Exceeds 200-V Machine Model (A115)
  - Exceeds 2000-V Human Body Model (A114)
  - Exceeds 1000-V Charged Device Model (C101)
- Latch-Up Exceeds 100mA per JESD 78, Class I
- **Totally Lead-Free & Fully RoHS Compliant (Notes 1 & 2)**
- **Halogen and Antimony Free. "Green" Device (Note 3)**

Notes:

1. No purposely added lead. Fully EU Directive 2002/95/EC (RoHS) & 2011/65/EU (RoHS 2) compliant.
2. See [http://www.diodes.com/quality/lead\\_free.html](http://www.diodes.com/quality/lead_free.html) for more information about Diodes Incorporated's definitions of Halogen- and Antimony-free, "Green" and Lead-free.
3. Halogen- and Antimony-free "Green" products are defined as those which contain <900ppm bromine, <900ppm chlorine (<1500ppm total Br + Cl) and <1000ppm antimony compounds.

## Pin Assignments

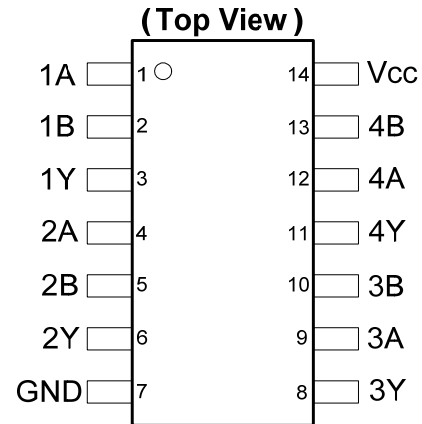

**SO-14 / TSSOP-14**

## Applications

- General Purpose Logic
- Power Down Signal Isolation
- Wide array of products such as:
  - PCs, networking, notebooks, ultrabooks, netbooks
  - Computer peripherals, hard drives, CD/DVD ROM
  - TV, DVD, DVR, set top box

[Click for Ordering Information](#)

### Pin Descriptions

Pin Number	Pin Name	Description
1	1A	Data Input
2	1B	Data Input
3	1Y	Data Output
4	2A	Data Input
5	2B	Data Input
6	2Y	Data Output
7	GND	Ground
8	3Y	Data Output
9	3A	Data Input
10	3B	Data Input
11	4Y	Data Output
12	4A	Data Input
13	4B	Data Input
14	Vcc	Supply Voltage

### Logic Diagram

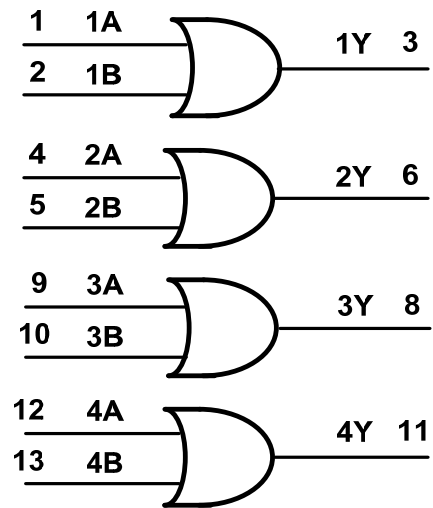

### Function Table

Inputs		Output
A	B	Y
L	L	L
H	X	H
X	H	H

### Absolute Maximum Ratings (Note 4) (@T<sub>A</sub> = +25°C, unless otherwise specified.)

Symbol	Description	Rating	Unit
ESD HBM	Human Body Model ESD Protection	2	kV
ESD CDM	Charged Device Model ESD Protection	1	kV
ESD MM	Machine Model ESD Protection	200	V
V <sub>CC</sub>	Supply Voltage Range	-0.5 to +7.0	V
V <sub>I</sub>	Input Voltage Range (Note 4)	-0.5 to +7.0	V
I <sub>IK</sub>	Input Clamp Current V <sub>I</sub> < 0V	-20	mA
I <sub>OK</sub>	Output Clamp Current V <sub>O</sub> < -0V	-50	mA
I <sub>O</sub>	Continuous Output Current -0.5V < V <sub>O</sub> < V <sub>CC</sub> + 0.5V	±25	mA
I <sub>CC</sub>	Continuous Current Through V <sub>CC</sub>	50	mA
I <sub>GND</sub>	Continuous Current Through GND	-50	mA
T <sub>J</sub>	Operating Junction Temperature	-40 to +150	°C
T <sub>STG</sub>	Storage Temperature	-65 to +150	°C
P <sub>TOT</sub>	Total Power Dissipation	500	mW

Note: 4. Stresses beyond the absolute maximum may result in immediate failure or reduced reliability. These are stress values and device operation should be within recommend values.

**Recommended Operating Conditions** (Note 5) (@ $T_A = +25^\circ\text{C}$ , unless otherwise specified.)

Symbol	Parameter	Conditions	Min	Max	Unit
$V_{CC}$	Supply Voltage	—	2.0	5.5	V
$V_I$	Input Voltage	—	0	5.5	V
$V_O$	Output Voltage	—	0	$V_{CC}$	V
$I_{OH}$	High-Level Output Current	2.0V	—	-50	mA
		2.3V to 2.7V	—	-2	$\mu\text{A}$
		3.0V to 3.6V	—	-6	mA
		4.5V to 5.5V	—	-12	mA
$I_{OL}$	Low-Level Output Current	2.0V	—	50	$\mu\text{A}$
		2.3V to 2.7V	—	2	mA
		3.0V to 3.6V	—	6	mA
		4.5V to 5.5V	—	12	mA
$\Delta t/\Delta V$	Input Transition Rise or Fall Rate	2.3V to 2.7V	—	200	ns/V
		3.0V to 3.6V	—	100	
		4.5V to 5.5V	—	20	
$T_A$	Operating Free-Air Temperature	—	-40	+125	$^\circ\text{C}$

 Note: 5. Unused inputs should be held at  $V_{CC}$  or Ground.

**Electrical Characteristics** (@ $T_A = +25^\circ\text{C}$ , unless otherwise specified.)

Symbol	Parameter	Test Conditions	$V_{CC}$	$T_A = -40^\circ\text{C to } +85^\circ\text{C}$		$T_A = -40^\circ\text{C to } +125^\circ\text{C}$		Unit
				Min	Max	Min	Max	
$V_{IH}$	High-Level Input Voltage	—	2.0V	1.5	—	1.5	—	V
		—	2.3V to 2.7V	$V_{CC} \times 0.7$	—	$V_{CC} \times 0.7$	—	
		—	3.0V to 3.6V	$V_{CC} \times 0.7$	—	$V_{CC} \times 0.7$	—	
		—	4.5V to 5.5V	$V_{CC} \times 0.7$	—	$V_{CC} \times 0.7$	—	
$V_{IL}$	Low-Level Input Voltage	—	2.0V	—	0.5	—	0.5	V
		—	2.3V to 2.7V	—	$V_{CC} \times 0.3$	—	$V_{CC} \times 0.3$	
		—	3.0V to 3.6V	—	$V_{CC} \times 0.3$	—	$V_{CC} \times 0.3$	
		—	4.5V to 5.5V	—	$V_{CC} \times 0.3$	—	$V_{CC} \times 0.3$	
$V_{OH}$	High-Level Output Voltage	$I_{OH} = -50\mu\text{A}$	2.0V to 5.5V	$V_{CC}-0.1$	—	$V_{CC}-0.1$	—	V
		$I_{OH} = -2\text{mA}$	2.3V	2.0	—	2.0	—	
		$I_{OH} = -6\text{mA}$	3.0V	2.48	—	2.48	—	
		$I_{OH} = -12\text{mA}$	4.5V	3.8	—	3.8	—	
$V_{OL}$	Low-Level Output Voltage	$I_{OL} = 50\mu\text{A}$	2.0V to 5.5V	—	0.1	—	0.1	V
		$I_{OL} = 2\text{mA}$	2.3V	—	0.4	—	0.4	
		$I_{OL} = 6\text{mA}$	3.0V	—	0.44	—	0.44	
		$I_{OL} = 12\text{mA}$	4.5V	—	0.55	—	0.55	
$I_{OFF}$	Power Down Leakage Current	$V_I$ or $V_O = 0$ to 5.5V	0V	—	5	—	5	$\mu\text{A}$
$I_I$	Input Current	$V_I = \text{GND}$ or 5.5V	0 to 5.5V	—	$\pm 1$	—	$\pm 1$	$\mu\text{A}$
$I_{CC}$	Supply Current	$V_I = \text{GND}$ or $V_{CC}$ $I_O = 0$	5.5V	—	20	—	20	$\mu\text{A}$

### Switching Characteristics

Symbol	Parameter	Test Conditions	V <sub>CC</sub>	T <sub>A</sub> = +25°C			-40°C to +85°C		-40°C to +125°C		Unit
				Min	Typ	Max	Min	Max	Min	Max	
t <sub>PD</sub>	Propagation Delay A <sub>N</sub> to Y <sub>N</sub>	Figure 1 C <sub>L</sub> = 15pF	2.5V ± 0.2V	—	7.1	12.8	1	15	1	16	ns
			3.3V ± 0.3V	—	5	7.9	1	9.5	1	9.5	
			5.0V ± 0.5V	—	3.6	5.5	1	6.5	1	6.5	
		Figure 1 C <sub>L</sub> = 50pF	2.5V ± 0.2V	—	9.6	16.2	1	19	1	20	ns
			3.3V ± 0.3V	—	6.9	11.4	1	13	1	13	
			5.0V ± 0.5V	—	4.9	7.5	1	8.5	1	8.5	

### Operating Characteristics

T<sub>A</sub> = +25°C

Parameter	Test Conditions	V <sub>CC</sub>	Typ	Unit	
C <sub>pd</sub>	Power Dissipation Capacitance per Gate	f = 10MHz	3.3V	9.5	pF
		C <sub>L</sub> = 50pF	5.0V	11.5	

### Noise Characteristics

V<sub>CC</sub> = 3V, C<sub>L</sub> = 50pF, T<sub>A</sub> = +25°C

Symbol	Parameter	Min	Typ	Max	Unit
V <sub>OL(p)</sub>	Quiet output, maximum dynamic V <sub>OL</sub>	—	0.2	0.8	V
V <sub>OL(v)</sub>	Quiet output, minimum dynamic V <sub>OL</sub>	—	-0.1	-0.8	V
V <sub>OH(v)</sub>	Quiet output, minimum dynamic V <sub>OH</sub>	—	3.1	—	V
V <sub>IH(D)</sub>	High Level dynamic input voltage	2.31	—	—	V
V <sub>IL(D)</sub>	Low Level dynamic input voltage	—	—	0.99	V

### Package Characteristics

Symbol	Parameter	Test Conditions	V <sub>CC</sub>	Min	Typ	Max	Unit
C <sub>i</sub>	Input Capacitance	V <sub>i</sub> = V <sub>CC</sub> – or GND	2.0 to 5.5V	—	3.3	10	pF

**Parameter Measurement Information**

From Output Under Test

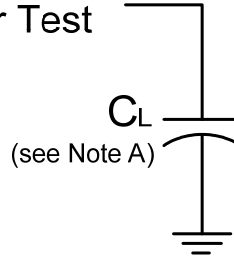

$V_{CC}$	Inputs		$V_M$	$C_L$
	$V_I$	$t_r/t_f$		
2.0V to 5.5V	$V_{CC}$	<3ns	$V_{CC}/2$	15pF or 50pF

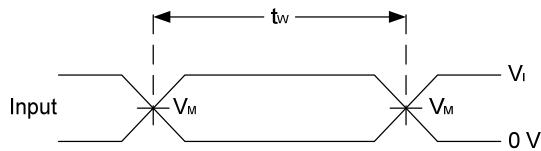

**Voltage Waveform  
Pulse Duration**

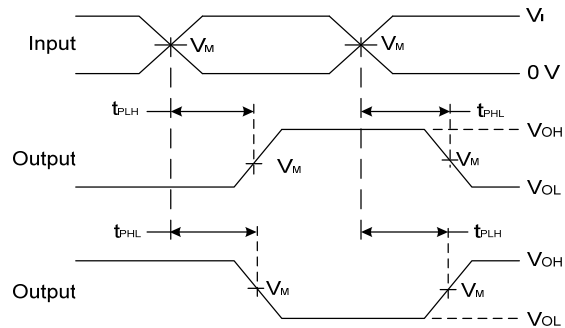

**Voltage Waveform  
Propagation Delay Times  
Inverting and Non Inverting Outputs**

- Notes:
- A. Includes test lead and test apparatus capacitance.
  - B. All pulses are supplied at pulse repetition rate  $\leq 10$ MHz.
  - C. Inputs are measured separately one transition per measurement.
  - D.  $t_{PLH}$  and  $t_{PHL}$  are the same as  $t_{PD}$ .

**Figure 1 Load Circuit and Voltage Waveforms**

**Ordering Information**

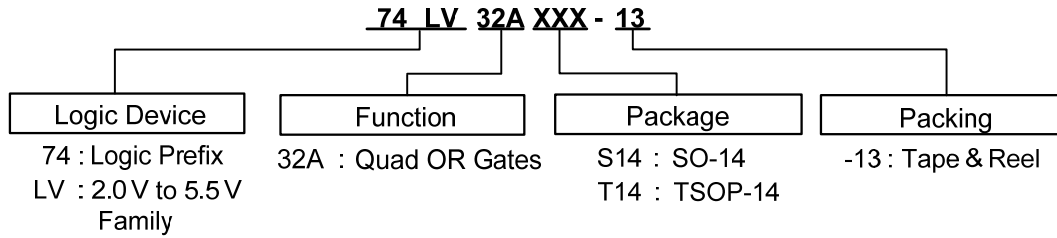

Device	Package Code	Packaging (Note 6)	13" Tape and Reel	
			Quantity	Part Number Suffix
74LV32AS14-13	S14	SO-14	2500/Tape & Reel	-13
74LV32AT14-13	T14	TSSOP-14	2500/Tape & Reel	-13

Note: 6. The taping orientation and tape details can be found at <http://www.diodes.com/datasheets/ap02007.pdf>

**Marking Information**

(1) SO14, TSSOP14

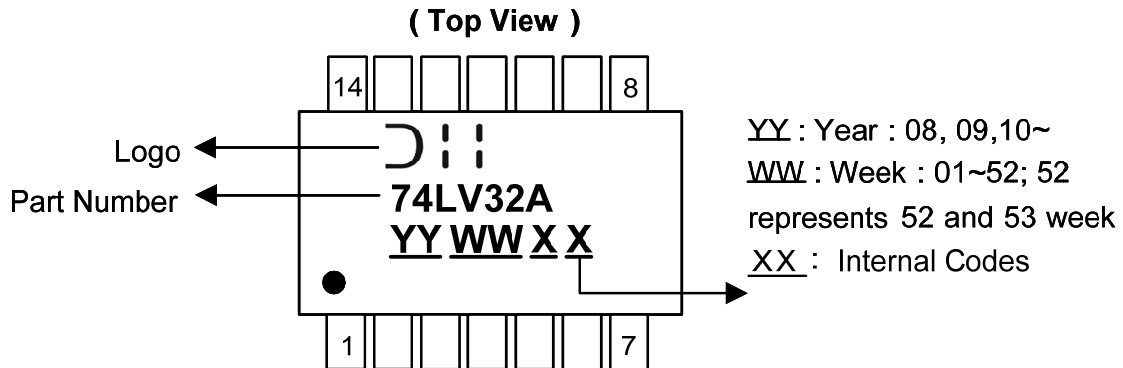

Part Number	Package
74LV32AS14	SO-14
74LV32AT14	TSSOP-14

**Package Outline Dimensions** (All Dimensions in mm)

Please see AP02002 at <http://www.diodes.com/datasheets/ap02002.pdf> for latest version.

**Package Type: SO-14**

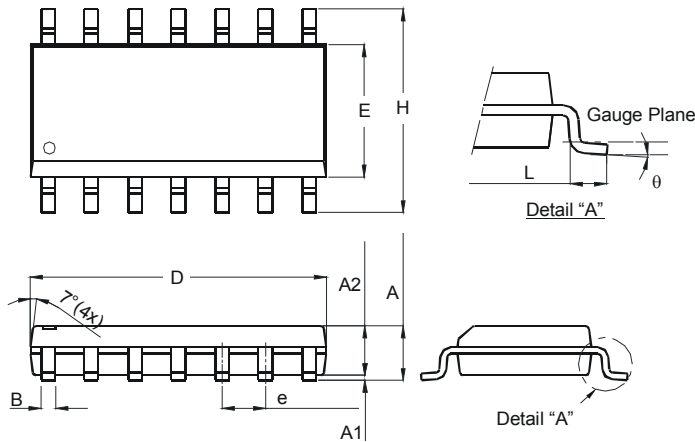

SO-14		
Dim	Min	Max
A	1.47	1.73
A1	0.10	0.25
A2	1.45 Typ	
B	0.33	0.51
D	8.53	8.74
E	3.80	3.99
e	1.27 Typ	
H	5.80	6.20
L	0.38	1.27
θ	0°	8°
All Dimensions in mm		

**Package Type: TSSOP-14**

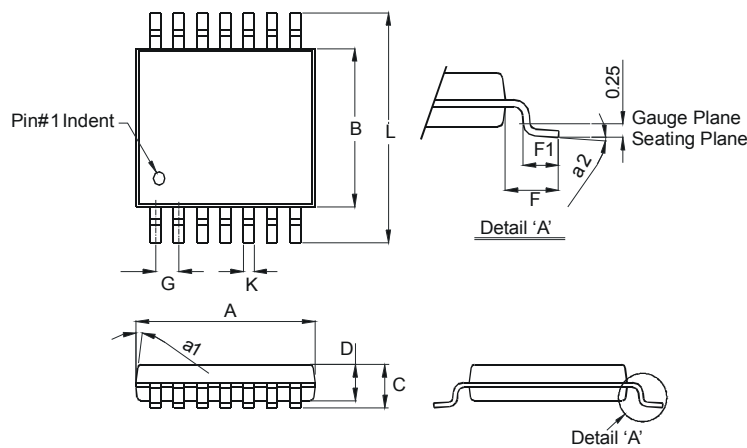

TSSOP-14		
Dim	Min	Max
a1	7° (4X)	
a2	0°	8°
A	4.9	5.10
B	4.30	4.50
C	—	1.2
D	0.8	1.05
F	1.00 Typ	
F1	0.45	0.75
G	0.65 Typ	
K	0.19	0.30
L	6.40 Typ	
All Dimensions in mm		

## Suggested Pad Layout

Please see AP02001 at <http://www.diodes.com/datasheets/ap02001.pdf> for the latest version.

Package Type: SO-14

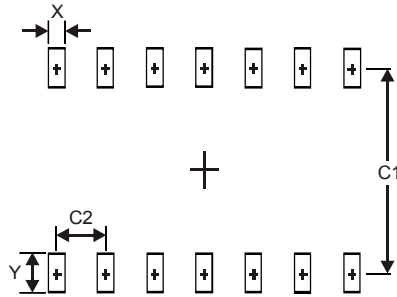

Dimensions	Value (in mm)
X	0.60
Y	1.50
C1	5.4
C2	1.27

NEW PRODUCT

Package Type: TSSOP-14

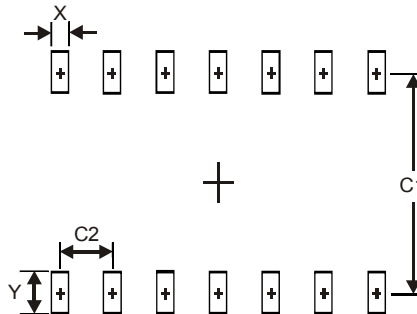

Dimensions	Value (in mm)
X	0.45
Y	1.45
C1	5.9
C2	0.65



**IMPORTANT NOTICE**

DIODES INCORPORATED MAKES NO WARRANTY OF ANY KIND, EXPRESS OR IMPLIED, WITH REGARDS TO THIS DOCUMENT, INCLUDING, BUT NOT LIMITED TO, THE IMPLIED WARRANTIES OF MERCHANTABILITY AND FITNESS FOR A PARTICULAR PURPOSE (AND THEIR EQUIVALENTS UNDER THE LAWS OF ANY JURISDICTION).

Diodes Incorporated and its subsidiaries reserve the right to make modifications, enhancements, improvements, corrections or other changes without further notice to this document and any product described herein. Diodes Incorporated does not assume any liability arising out of the application or use of this document or any product described herein; neither does Diodes Incorporated convey any license under its patent or trademark rights, nor the rights of others. Any Customer or user of this document or products described herein in such applications shall assume all risks of such use and will agree to hold Diodes Incorporated and all the companies whose products are represented on Diodes Incorporated website, harmless against all damages.

Diodes Incorporated does not warrant or accept any liability whatsoever in respect of any products purchased through unauthorized sales channel.

Should Customers purchase or use Diodes Incorporated products for any unintended or unauthorized application, Customers shall indemnify and hold Diodes Incorporated and its representatives harmless against all claims, damages, expenses, and attorney fees arising out of, directly or indirectly, any claim of personal injury or death associated with such unintended or unauthorized application.

Products described herein may be covered by one or more United States, international or foreign patents pending. Product names and markings noted herein may also be covered by one or more United States, international or foreign trademarks.

This document is written in English but may be translated into multiple languages for reference. Only the English version of this document is the final and determinative format released by Diodes Incorporated.

**LIFE SUPPORT**

Diodes Incorporated products are specifically not authorized for use as critical components in life support devices or systems without the express written approval of the Chief Executive Officer of Diodes Incorporated. As used herein:

A. Life support devices or systems are devices or systems which:

1. are intended to implant into the body, or
2. support or sustain life and whose failure to perform when properly used in accordance with instructions for use provided in the labeling can be reasonably expected to result in significant injury to the user.

B. A critical component is any component in a life support device or system whose failure to perform can be reasonably expected to cause the failure of the life support device or to affect its safety or effectiveness.

Customers represent that they have all necessary expertise in the safety and regulatory ramifications of their life support devices or systems, and acknowledge and agree that they are solely responsible for all legal, regulatory and safety-related requirements concerning their products and any use of Diodes Incorporated products in such safety-critical, life support devices or systems, notwithstanding any devices- or systems-related information or support that may be provided by Diodes Incorporated. Further, Customers must fully indemnify Diodes Incorporated and its representatives against any damages arising out of the use of Diodes Incorporated products in such safety-critical, life support devices or systems.

Copyright © 2013, Diodes Incorporated

[www.diodes.com](http://www.diodes.com)