

General Description

The AAT2610 is a highly integrated power management solution specifically suited for Digital Still Camera (DSC) systems, featuring seven DC-DC switching regulators for maximum operating efficiency.

The input operating voltage range is 1.6 to 5.5V, making the device an ideal solution for 1-cell Li-ion batteries, 2-cell alkaline batteries, and USB and regulated AC-DC wall adapters. All seven DC-DC switching regulators feature high efficiency light load operating mode to extend battery life while in low power standby state.

Three different DC-DC building blocks provide maximum design flexibility: a boost (step-up) DC-DC controller with an output voltage range of 3.0V to 5.5V and a current mode control buck (step-down) or boost (step-up) DC-DC controller with an output voltage range of 2.5V to the step-up converter (SU) output voltage and buck output range of 0.6V to V_{IN} . Dual current mode control synchronous buck regulators provide low voltage, low noise outputs required for system logic and memory. Output voltage range is 0.6V to V_{IN} . The Auxiliary 1 boost (step-up) is ideally suited for LCD backlight and can drive 1-6 white LEDs up to a maximum of 30mA with $\pm 10\%$ accuracy. PWM input controls LED dimming across the frequency range from 10% to 100% duty cycle. The integrated OVP and SCF feature protects the device from open-circuit LED conditions.

The Auxiliary 2 boost (step-up) and Auxiliary 3 buck-boost (inverting) output provide low noise ($\leq 30\text{mVpp}$) +15V and -7.5V outputs for CCD loads. An expensive transformer is not required.

No external MOSFETs and low profile TQFN55-40L package are ideal to save space for DSC solution. Integrated, low $R_{DS(ON)}$ power MOSFETs provide output voltages from 0.6V to 16VDC and an inverting output up to -10V. The high switching frequency ensures small external filtering components. Internal compensation is provided for optimum transient performance and minimum application design effort.

Features

- Input Voltage Range 1.6 to 5.5V
 - 1-Cell Li-ion, 2-Cell Alkaline
 - Adapter or USB Inputs
- 7 Channel up to 96% High Efficiency DC/DCs
 - Adjustable Output
 - 4 Channel Synchronous Rectification
 - Light Load Mode for High Efficiency
- $< 1\mu\text{A}$ Total Quiescent Current
- Current Mode Control
 - Fast, Stable Transient Response
 - No External Compensation
 - Current Limit for Internal MOSFET Protection
- High Frequency 1.5MHz System Clock
- High Voltage Series LED Driver
 - 1 to 6 White LEDs
 - Up to Maximum 30mA LED Current
 - External Schottky Diode
 - $\pm 10\%$ Accuracy Current Sink
 - Integrated OVP
 - PWM Dimming: 1k to 30kHz, 10 to 100% Duty Cycle
- Step-Up and Inverting Outputs for CCD
 - Low Noise Outputs
 - Transformerless Inverter Output
- Flexible Sequencing Implementation
 - Independent Enable Control
 - 10ms Pre-Programmed Buck or Boost Delay
- Integrated Soft-Start
- Over-Voltage and Over-Temperature Protection
- Pb-free TQFN55-40L Package
- Temperature Range: -40°C to $+85^{\circ}\text{C}$

Applications

- DSCs and DVCs
- MP3 Players
- PMP

Typical Applications

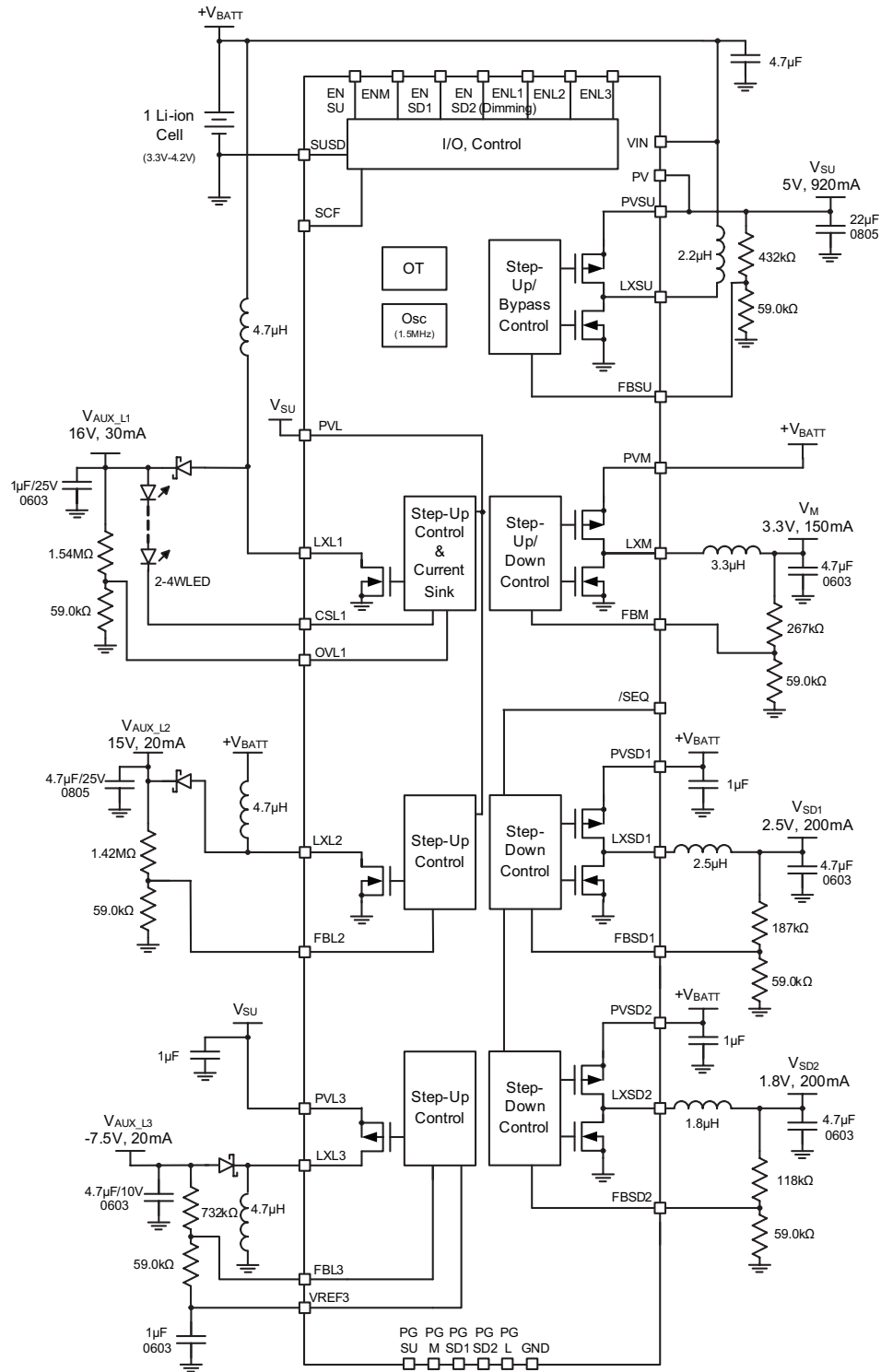

1. Single Cell Li-ion Battery Input, 5V Motor.

Seven-Channel PMU for Digital Still Cameras

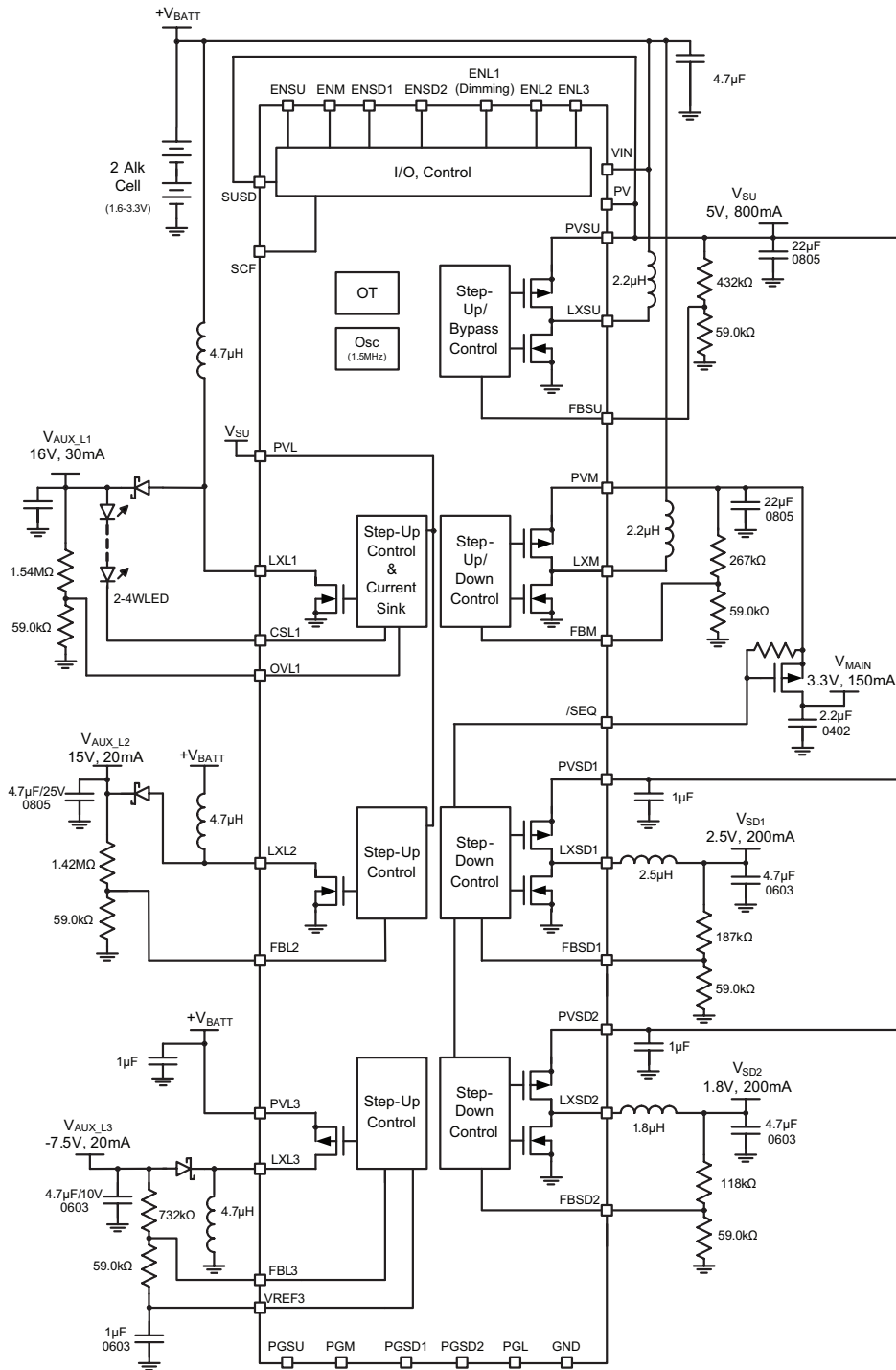

2. Dual Cell Alkaline Battery Input, 5V Motor.

Seven-Channel PMU for Digital Still Cameras

Pin Descriptions

Number	Symbol	Description
1	FBL2	Auxiliary 2 (AUX_L2) boost converter feedback pin. This pin is high impedance when the AUX2 controller is disabled. Connect an external resistor divider between this pin and AUX2 output and GND to set the AUX2 output voltage with 0.6V.
2	FBSD1	Step-down 1 (SD1) buck converter feedback pin. This pin is high impedance when the SD1 controller is disabled. Connect an external resistor divider between this pin and SD1 output and GND to set the SD1 output voltage with 0.6V.
3	PVSD1	Step-down 1 (SD1) buck converter input pin. Bypass to GND plane with a 1 μ F ceramic capacitor.
4	LXSD1	Step-down 1 (SD1) buck converter switching node. Connect this pin to an external inductor. This pin is high impedance when the SD1 converter is disabled.
5	PGSD1	Step-down 1 (SD1) buck converter power ground. Tie this pin to ground plane.
6	PGM	Main (SUD) converter power ground. Tie this pin to ground plane.
7	LXM	If SUSD is pulled high, the Main is a boost (step-up) converter and the pin functions as the Main converter switching node. In this case, connect this pin to the external inductor. If SUSD is pulled low, the Main is a buck (step-down) converter and the pin functions as the Main converter switching node. In this case, connect this pin to the external inductor. In either case, LXM is high impedance when the Main converter is disabled.
8	PVM	If SUSD is pulled high, the Main is a boost (step-up) converter and this pin functions as the Main converter output. In this case, connect a ceramic capacitor to GND plane from this pin. If SUSD is pulled low, the Main is a buck (step-down) converter and this pin functions as the Main converter input voltage. In this case, connect this pin to the external inductor.
9	FBM	Main (M) buck or boost converter feedback pin. This pin is high impedance when the Main controller is disabled. Connect an external resistor divider between this pin and Main output and GND to set the Main output voltage with 0.6V.
10	$\overline{\text{SEQ}}$	Main (M) converter open-drain output sequencing pin. This pin is internally pulled low after both SD1 and SD2 converters completed soft-start and achieved output regulation. This pin can provide gate drive to external P-channel MOSFETs which disconnect the load during start-up. This pin is open-circuit during shut-down, overload or during OT trip conditions.
11	SUSD	Main converter configuration pin. Tie this pin to high to configure the Main output as a boost (step-up) converter, or tie this pin to low to configure the Main output as a buck (step-down) converter. This pin cannot be toggled during operation.
12	ENL3	Auxiliary 3 (AUX_L3) buck-boost (inverting) converter active high enable pin. The AUX_L3 output remains disabled until 2,048 clock cycles after Step-Up (SU) output has reached regulation. The pin has an internal 330k Ω pull-down resistor.
13	ENL2	Auxiliary 2 (AUX_L2) boost converter active high enable pin. The AUX_L2 output remains disabled until 2,048 clock cycles after Step-Up (SU) output has reached regulation. The pin has an internal 330k Ω pull-down resistor.
14	ENL1	Auxiliary 1 (AUX_L1) boost converter active high enable pin. The Main output remains disabled until 2,048 clock cycles after Step-Up (SU) output has reached regulation. The pin has an internal 330k Ω pull-down resistor. This pin also functions as PWM input for the LED dimming feature. The input PWM frequency is logic level high and low within 1kHz to 30kHz frequency. PWM dimming input duty cycle (ON-time/TOTAL-time) range is from 10% to 100%.
15	VIN	Input voltage. Tie this pin to the input of step-up (SU).
16	GND	Chip ground. Tie this pin to ground plane.
17	PV	Power input for the PMIC. Connect this pin directly to the PVSU pin.
18	ENSD2	Step-down 2 (SD2) buck converter active high enable pin. The SD2 output remains disabled until 2,048 clock cycles after Step-Up (SU) output has reached regulation. This pin has an internal 330k Ω pull-down resistor.
19	ENSD1	Step-down 1 (SD1) buck converter active high enable pin. The SD1 output remains disabled until 2,048 clock cycles after Step-Up (SU) output has reached regulation. This pin has an internal 330k Ω pull-down resistor.
20	ENM	Main buck or boost converter active high enable pin. However, the Main output remains disabled until 2,048 clock cycles after Step-Up (SU) output has reached regulation. This pin has an internal 330k Ω pull-down resistor.
21	ENSU	Step-up (SU) boost converter active high enable pin. This pin has an internal 330k Ω pull-down resistor.

Seven-Channel PMU for Digital Still Cameras**Pin Descriptions**

Number	Symbol	Description
22	SCF	Open drain, active low, short circuit flag output. SCF goes open when overload protection or AUX_L1 open circuit occur during abnormal operation or during startup. SCF can drive P-channel MOSFETs to disconnect a given output from the load.
23	FBSU	Step-up (SU) boost converter feedback pin. This pin is high impedance when the SU controller is disabled. Connect an external resistor divider between this pin and SU output and GND to set the SU output voltage with 0.6V.
24	PVSU	Step-up (SU) boost converter input.
25	LXSU	Step-up (SU) boost converter switching node. Connect this pin to the external inductor and anode of the Schottky rectifying diode. This pin is high impedance when the SU converter is disabled.
26	PGSU	Step-up (SU) boost converter power ground. Tie this pin to ground plane.
27	PGSD2	Step-down 2 (SD2) buck converter power ground pin. Tie this pin to ground plane.
28	LXSD2	Step-down 2 (SD2) buck converter switching node. Connect this pin to an external inductor. This pin is high impedance when the SD2 converter is disabled.
29	PVSD2	Step-down 2 (SD2) buck converter input pin. Bypass this pin to GND plane with a 1 μ F ceramic capacitor.
30	FBSD2	Step-down 2 (SD2) buck converter feedback pin. This pin is high impedance when the SD2 controller is disabled. Connect an external resistor divider between this pin and SD2 output and GND to set the SD2 output voltage with 0.6V.
31	VREF3	Auxiliary 3 (AUX_L3) buck/boost (inverting) reference voltage pin. Bypass VREF3 to GND with a 1 μ F or greater capacitor. Connect an external resistor divider between this pin and L3 output and FBL with 0.6V.
32	FBL3	Auxiliary 3 (AUX_L3) boost converter feedback pin. The pin is high impedance when the AUX_L3 controller is disabled. Connect an external resistor divider between this pin and AUX_L3 output and VREF3 pin to set the AUX_L3 negative buck/boost (inverting) output voltage with 0V.
33	PVL3	Auxiliary 3 (AUX_L3) buck/boost (inverting) input node. Connect this pin to the input ceramic capacitor.
34	LXL3	Auxiliary 3 (AUX_L3) buck/boost (inverting) switching node. Connect this pin to the cathode of the external Schottky diode and buck/boost inductor.
35	PVL	Power input for auxiliary (AUX_L1, AUX_L2, AUX_L3) channels' power FET driver. Tie this pin to PVSU.
36	LXL2	Auxiliary 2 (AUX_L2) boost (step-up) switching node. Connect this pin to the anode of the external Schottky diode and boost inductor.
37	PGL	Power ground for auxiliary (AUX_L1, AUX_L2, AUX_L3) channels' power FET driver. Tie this pin to ground plane.
38	LXL1	Auxiliary 1 (AUX_L1) boost (step-up) switching node. Connect this pin to the anode of the external Schottky diode and boost inductor.
39	CSL1	Auxiliary 1 (AUX_L1) boost converter current sink pin. The pin is high impedance when the AUX_L1 controller is disabled. Connect this pin to the cathode of the bottom LED in the string to ensure DC current flow. Current level is programmed by the internal RSET resistor from 1mA to 30mA.
40	OVL1	Auxiliary 1 (AUX_L1) boost (step-up) over-voltage protection pin. Connect an external resistor divider between this pin and AUX_L1 output voltage and GND to set the AUX_L1 over-voltage threshold with 0.6V.
EP		Exposed pad (bottom). Connect to ground directly beneath the package for thermal dissipation.

Seven-Channel PMU for Digital Still Cameras

Electrical Characteristics¹

Unless otherwise noted $V_{PVSU} = V_{PVM} = V_{PVS1} = V_{PVS2} = 3.6V$, $T_A = -40^{\circ}C$ to $+85^{\circ}C$.

Symbol	Description	Conditions	Min	Typ	Max	Units
General						
V_{IN}	Operating Input Voltage Range	$I_{LOAD} \leq$ Full Load (see Tables 1 and 2)	1.6		5.5	V
I_{SHDN}	Shutdown Supply Current	$EN_{SU} = EN_M = EN_{SD1} = EN_{SD2} = 0V$, $EN_{DL1} = EN_{DL2} = EN_{DL3} = 0V$		0.01	10	μA
I_Q	Quiescent Current into PV Pin with SU Enabled	$EN_{SU} = 3.6V$, $FBSU = 1.5V$ (does not include switching losses)		300	450	μA
	Quiescent Current into PV Pin with SU/SD1/SD2 Enabled	$EN_{SU} = EN_{SD1} = EN_{SD2} = 3.6V$, $FBSU = FBSD1 = FBSD2 = 1.5V$, $EN_M = EN_{DL1} = EN_{DL2} = EN_{DL3} = 0V$ (does not include switching losses)		600	900	μA
	Quiescent Current into PV Pin with SU/SUD Enabled	$EN_{SU} = EN_M = 3.6V$, $FBSU = FBSUD = 1.5V$, $EN_{SD1} = EN_{SD2} = EN_{DL1} = EN_{DL2} = EN_{DL3} = 0$ (does not include switching losses)		450	700	μA
	Quiescent Current into PV Pin with	$EN_{SU} = EN_{DL1} = 3.6V$, $FBSU = FBL1 = 1.5V$, $EN_M = EN_{SD1} = EN_{SD2} = EN_{DL1} = EN_{DL2} = EN_{DL3} = 0$ (does not include switching losses)		400	650	μA
Oscillator						
F_{OSC}	Oscillator Frequency Range		1.2	1.5	1.8	MHz
SU DC-DC Boost (Step-Up) Converter						
$V_{UVLO(SU)}$	SU Under-Voltage Threshold	Rising edge	1.6	1.8	2.0	V
$V_{UVLO(SU),HYS}$	SU Under-Voltage Threshold Hysteresis	Falling edge		400		mV
$V_{OUT(SU)}$	Step-Up Output Voltage Range		3.0		5.5	V
$V_{IN(BP-ENTER)}$	Enter Bypass Mode	V_{IN} Rising edge	4.625	4.750	4.900	V
$V_{IN-HYS(BP-EXIT)}$	Exit Bypass Mode - Hysteresis	V_{IN} Falling edge	100	112	125	mV
t_{DELAY}	Start-Up Delay of SUSU, SD1, SD2, AUX_L1, AUX_L2, AUX_L3 after VSU in Regulation			512		OSC Cyc
V_{FBSU}	FBSU Reference Voltage	$T_A = 25^{\circ}C$	0.585	0.600	0.615	V
$I_{MODE(SU)}$	SU Light Load Mode Current Threshold			200		mA
$D_{MAX(SU)}$	Step-Up Maximum Duty Cycle	$1.6 \leq V_{PVSU} \leq 5.0V$, $V_{FBSU} = 0.60V$	85	95		%
$I_{LEAK(FBSU)}$	FBSU Pin Leakage Current	$V_{FBSU} = 0.60V$	-100	0.01	+100	nA
$I_{LEAK(PVSU)}$	PVSU Pin Leakage Current	$V_{LXSU} = 0V$, $V_{PVSU} = 5.5V$		0.1	5	μA
$I_{LEAK(LXSU)}$	LXSU Pin Leakage Current	$V_{LXSU} = V_{OUT(SU)} = 5.5V$		0.1	5	μA
$R_{DS(ON)}$	N-Channel			50		$m\Omega$
	P-Channel			130		$m\Omega$
I_{LIMIT}	N-Channel Current Limit		4.1	5.5		A
I_{OFF}	P-Channel Turn-Off Current			20		mA
$I_{STARTUP}$	Startup Current Limit	$V_{PVSU} = 1.8V$		1300		mA
$T_{OFF(STARTUP)}$	Startup Off-Time	$V_{PVSU} = 1.8V$		700		ns
$F_{OSC(STARTUP)}$	Startup Frequency	$V_{PVSU} = 1.8V$		200		kHz

1. The AAT2610 is guaranteed to meet performance specifications over the $-40^{\circ}C$ to $+85^{\circ}C$ operating temperature range and is assured by design, characterization, and correlation with statistical process controls.

Seven-Channel PMU for Digital Still Cameras

Electrical Characteristics¹

Unless otherwise noted $V_{PVSU}=V_{PVM}=V_{PVSD1}=V_{PVSD2}=3.6V$, $T_A=-40^{\circ}C$ to $+85^{\circ}C$.

Symbol	Description	Conditions	Min	Typ	Max	Units
Main DC-DC Buck (Step-Down) or Boost (Step-Up) Converter						
$V_{OUT(M)}$	Main Output Step-Up Voltage Range	$V_{SUSD} = V_{PVSU}$	3.0		5.5	V
	Main Output Step-Down Voltage Range	$V_{SUSD} = GND$; V_{PVM} must be greater than $V_{OUT(M)}$	1.0		V_{IN}	V
V_{FBM}	FBM Reference Voltage	$T_A = 25^{\circ}C$	0.585	0.60	0.615	V
$I_{LIMIT(M)}$	Step-Up Mode Current Limit	$V_{SUSD} = V_{PVSU}$	1.5	1.75		A
	Step-Down Mode Current Limit	$V_{SUSD} = GND$	0.7	0.85		A
$I_{MODE(M)}$	Step-Up Light Load Mode Current Threshold	$V_{SUSD} = V_{PVSU}$		350		mA
	Step-Down Light Load Mode Current Threshold	$V_{SUSD} = GND$		200		mA
$D_{MAX(M)}$	Step-Up Maximum Duty Cycle	$1.6 \leq V_{IN} \leq 5.0V$, $V_{SUSD} = V_{PVSU}$	80	95		%
	Step-Down Maximum Duty Cycle	$1.6 \leq V_{IN} \leq 5.0V$, $V_{SUSD} = GND$	100			
$I_{LEAK(FBM)}$	FBM Pin Leakage Current	$V_{FBSU} = 0.6V$	-100	0.01	+100	nA
$I_{LEAK(LXM)}$	LXM Pin Leakage Current	$V_{LXSU} = V_{OUT(M)} = 5.5V$		0.1	5	μA
R_{DSON}	N-Channel			75		$m\Omega$
	P-Channel			120		$m\Omega$
$I_{OFF(M)}$	Step-Up Mode N-Channel Turn-Off Current	$V_{SUSD} = V_{PVSU}$		20		mA
	Step-Down Mode N-Channel Turn-Off Current	$V_{SUSD} = GND$		20		
$t_{SOFT-START}$	Soft-Start Interval			2,048		OSC Cyc
T_{SEQ}	Sequencing Time Delay	SD1/SD2 Regulation to $V_{SEQ(L)}$ Transition		10,000		OSC Cyc
$I_{LEAK(SEQ)}$	SEQ Pin Leakage Current	$EN_SU = V_{PVSU}$, $FBSU = 1.5V$		0.1	1	μA
$V_{SEQ(L)}$	SEQ Low Output Voltage	0.1mA into SEQ pin		0.01	0.1	V
SD1/2 DC-DC Step-Down (Buck) Converters						
$V_{OUT(SD1/SD2)}$	SD1/SD2 Step-Down Output Voltage Range		0.60		V_{IN}	V
$V_{FB(SD1/SD2)}$	FBSD1, FBSD2 Reference Voltage	$T_A = 25^{\circ}C$	0.585	0.60	0.615	V
$I_{LIMIT(SD1/SD2)}$	P-Channel Current Limit		0.6	0.7		A
$I_{MODE(SD1/SD2)}$	SD1 Light Load Mode Current Threshold			100		mA
$D_{MAX(SD1/SD2)}$	Maximum Duty Cycle	$1.6 \leq V_{PVSU} \leq 5.0V$, $V_{SD1/2} = 0.60V$	100			%
$I_{LEAK(FBSD1/SD2)}$	FBSD1, FBSD2 Pin Leakage Current	$V_{FBSD1/SD2} = 0.6V$	-100	0.01	+100	nA
$I_{LEAK(LXSD1/SD2)}$	LXSD1, LXSD2 Pin Leakage Current	$V_{LXSD1/SD2} = 0$ to 3.6V		0.1	5	μA
$R_{DSON(SD1)}$	N-Channel			500		$m\Omega$
	P-Channel			650		$m\Omega$
$R_{DSON(SD2)}$	N-Channel			250		$m\Omega$
	P-Channel			450		$m\Omega$
I_{OFF}	N-Channel Turn-Off Current			20		mA
$T_{SOFTSTART}$	Soft-Start Interval			2,048		OSC Cyc

1. The AAT2610 is guaranteed to meet performance specifications over the $-40^{\circ}C$ to $+85^{\circ}C$ operating temperature range and is assured by design, characterization, and correlation with statistical process controls.

Seven-Channel PMU for Digital Still Cameras

Electrical Characteristics¹

Unless otherwise noted $V_{PVSU} = V_{PVM} = V_{PVSD1} = V_{PVSD2} = 3.6V$, $T_A = -40^{\circ}C$ to $+85^{\circ}C$.

Symbol	Description	Conditions	Min	Typ	Max	Units
AUX L1/L2 DC-DC Boost (Step-Up) Converters						
$V_{OUT(AUX_L1/L2)}$	AUX_L1/L2 Step-Up Output Voltage Range ²		5.0		20.0	V
I_{CSL1}	CSL1 Current Sink Accuracy	$T_A = 25^{\circ}C$	27.0	30.0	33.0	mA
V_{FBL2}	FBL2 Reference Voltage	$T_A = 25^{\circ}C$	0.585	0.60	0.615	V
V_{OVL1}	OVL1 Reference Voltage	$T_A = 25^{\circ}C$	0.585	0.60	0.615	V
$I_{LIMIT(AUX_L1)}$	N-Channel Current Limit		0.60	0.70		A
$I_{LIMIT(AUX_L2)}$	N -Channel Current Limit		0.60	0.70		A
$I_{MODE(AUX_L1/L2)}$	AUX_L1/L2 Light Load Mode Current Threshold			70		mA
$D_{MAX(L1/L2)}$	Maximum Duty Cycle		95			%
$I_{LEAK(FBL2)}$	FBL2 Pin Leakage Current		-100	0.01	+100	nA
$R_{DSON(AUX_L1)}$	N-Channel			1000		m Ω
$R_{DSON(AUX_L2)}$	N-Channel			1000		m Ω
$t_{SOFTSTART(AUX_L2)}$	AUX_L2 Soft-Start Interval			2,048		OSC Cyc
AUX L3 DC-DC Buck/Boost (Inverter) Converters						
V_{REF3}	REF3 Reference Voltage	$T_A = 25^{\circ}C$, $I_{REF} = 20\mu A$	0.585	0.60	0.615	V
V_{FBL3}	FBL3 Inverter Reference Voltage	$T_A = 25^{\circ}C$	-0.01	0.00	0.01	V
$I_{LIMIT(AUX_L3)}$	P-Channel Current Limit			1.5		A
$I_{MODE(AUX_L3)}$	SD1 Light Load Mode Current Threshold			100		mA
$I_{LEAK(REF3,FBL3)}$	REF3, FBL3 Pin Leakage Current		-100	0.01	+100	nA
R_{DSON}	P-Channel			1000		m Ω
$t_{SOFTSTART}$	Soft-Start Interval			2,048		OSC Cyc
Overload Protection						
$t_{DELAY(SCF)}$	Overload Fault Delay			100,000		OSC Cyc
$I_{LEAK(SCF)}$	SCF Pin Leakage Current	$EN_SU = V_{PVSU}$, $FBSU = 1.5V$		0.1	1	μA
$V_{L(SCF)}$	SCF Low Output Voltage	0.1mA into SCF pin		0.01	0.1	V
Thermal Protection						
T_{SD}	Over-Temperature Shutdown			140		$^{\circ}C$
T_{HYS}	Over-Temperature Shutdown Hysteresis			15		$^{\circ}C$

1. The AAT2610 is guaranteed to meet performance specifications over the $-40^{\circ}C$ to $+85^{\circ}C$ operating temperature range and is assured by design, characterization, and correlation with statistical process controls.

2. The Step-Up converter operates in startup mode until this voltage is reached. Do not apply full load current during startup.

Seven-Channel PMU for Digital Still Cameras

Electrical Characteristics¹

Unless otherwise noted $V_{PVSU}=V_{PVM}=V_{PVSD1}=V_{PVSD2}=3.6V$, $T_A=-40^{\circ}C$ to $+85^{\circ}C$.

Symbol	Description	Conditions	Min	Typ	Max	Units
Logic Inputs						
$V_{L(EN_SU)}$	EN_SU Logic Low Threshold	$1.1V < V_{PVSU} < 1.8V$			0.2	V
		$1.8V \leq V_{PVSU} < 2.5V$			0.4	V
		$2.5V \leq V_{PVSU} < 5.5V$			0.5	V
$V_{H(EN_SU)}$	EN_SU Logic High Threshold	$1.1V < V_{PVSU} < 1.8V$	$(V_{PVSU} - 0.2)$			V
		$1.8V < V_{PVSU} < 5.5V$	1.6			V
$V_{EN_x(L)}, V_{SUSD(L)}$	EN_x, SUSD Logic Low Threshold	$2.7V < V_{PVSU} < 5.5V$			0.5	V
$V_{EN_x(H)}, V_{SUSD(H)}$	EN_x, SUSD Logic High Threshold	$2.7V < V_{PVSU} < 5.5V$	1.6			V
$I_{LEAK(SUSD)}$	SUSD Pin Leakage Current			0.1	1	μA
R_{ENx}	ENx Input Impedance			330		$k\Omega$
$T_{EN_L1(L)}$	Disable Low Time	Dimming state: EN low to LED Disable; $2.7V < V_{IN} < 5V$	2	3	4	μs
$T_{EN_L1(H)}$	Enable High Time	Dimming state: EN high to LED Regulation; $2.7V < V_{IN} < 5V$	2	3	4	μs
$T_{EN_L1(DIS-L)}$	Disable Low Time	Disables Dimming state: Soft-start enabled on subsequent EN transition; $2.7V < V_{IN} < 5V$	1000		1200	μs

1. The AAT2610 is guaranteed to meet performance specifications over the $-40^{\circ}C$ to $+85^{\circ}C$ operating temperature range and is assured by design, characterization, and correlation with statistical process controls.

Typical Characteristics

SU Efficiency vs. Output Current

($V_{SU} = 5V$; $L = 2.2\mu H$; $C_{OUT} = 22\mu F$)

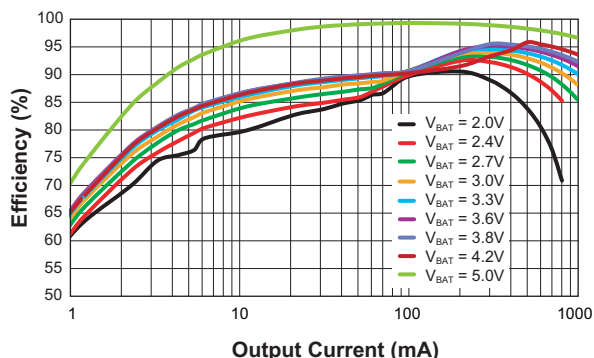

MSD Efficiency vs. Output Current

($V_{PVM} = V_{BAT}$; $V_{MSD} = 3.3V$; $L = 3.3\mu H$; $C_{OUT} = 4.7\mu F$)

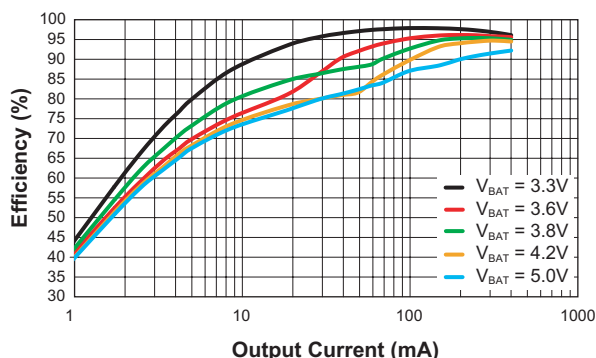

MSU Efficiency vs. Output Current

($V_{MSU} = 3.3V$; $L = 2.2\mu H$; $C_{OUT} = 10\mu F$)

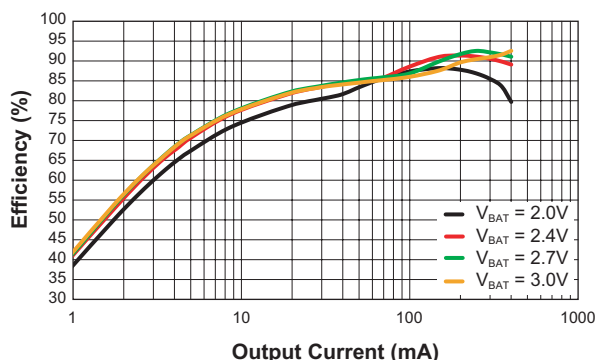

SD1 Efficiency vs. Output Current

($V_{PVSD1} = V_{BAT}$; $V_{SD1} = 2.5V$; $L = 2.2\mu H$; $C_{OUT} = 10\mu F$)

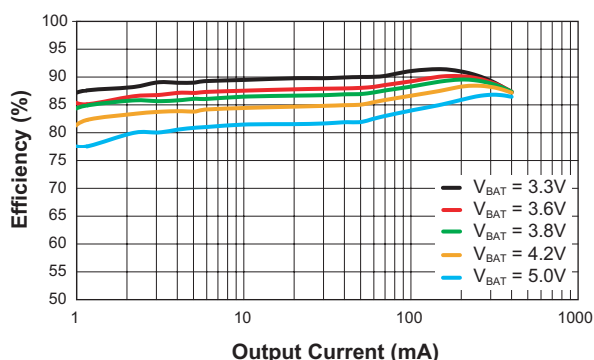

SD2 Efficiency vs. Output Current

($V_{PVSD2} = V_{BAT}$; $V_{SD2} = 1.8V$; $L = 2.2\mu H$; $C_{OUT} = 4.7\mu F$)

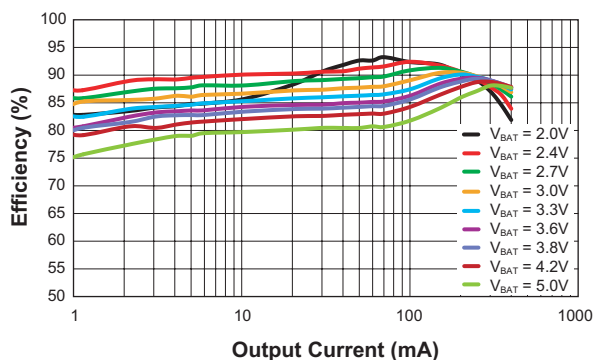

SD2 Efficiency vs. Output Current

($V_{SD2} = 1.2V$; $L = 2.2\mu H$; $C_{OUT} = 4.7\mu F$)

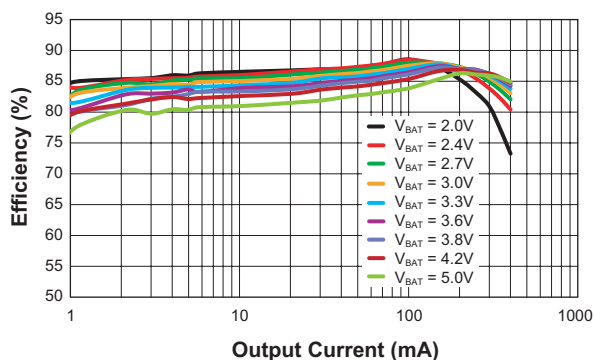

Seven-Channel PMU for Digital Still Cameras

Typical Characteristics

AUX1 Efficiency vs. PWM Duty Cycle
(4 WLEDs; L = 4.7μH; C_{OUT} = 1μF; 10kHz PWM Control)

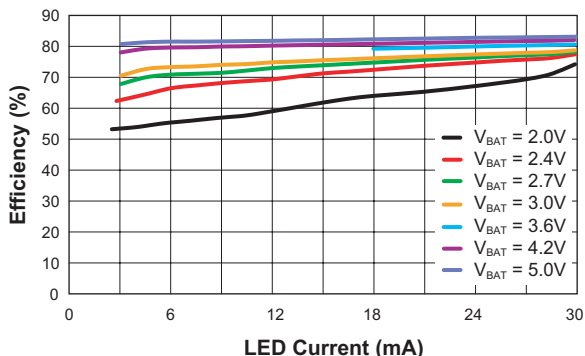

AUX2 Efficiency vs. Output Current
(V_{AUX2} = +15V; L = 4.7μH; C_{OUT} = 4.7μF)

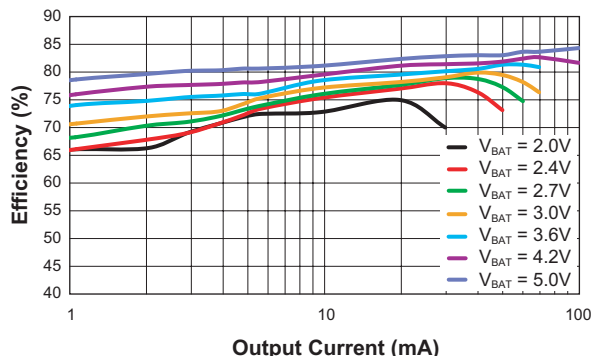

AUX3 Efficiency vs. Output Current
(V_{AUX3} = -7.5V; L = 4.7μH; C_{OUT} = 4.7μF)

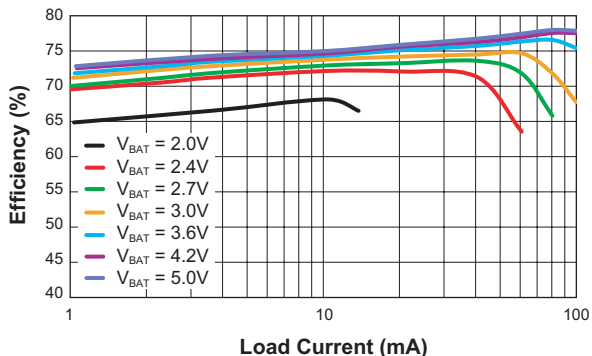

AUX1 PWM Duty Cycle vs. LED Current
(4 WLEDs; L = 4.7μH; C_{OUT} = 1μF; 10kHz PWM Control)

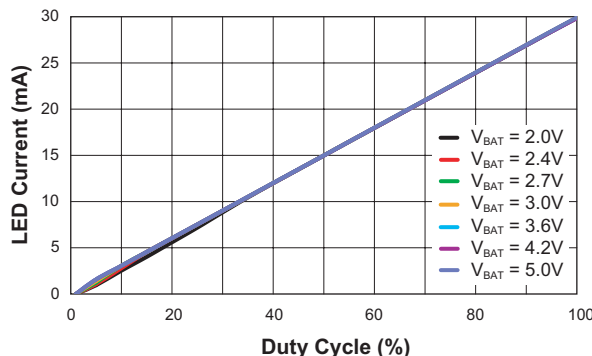

SU Load Regulation vs. Output Current
(V_{SU} = 5V; L = 2.2μH; C_{OUT} = 22μF)

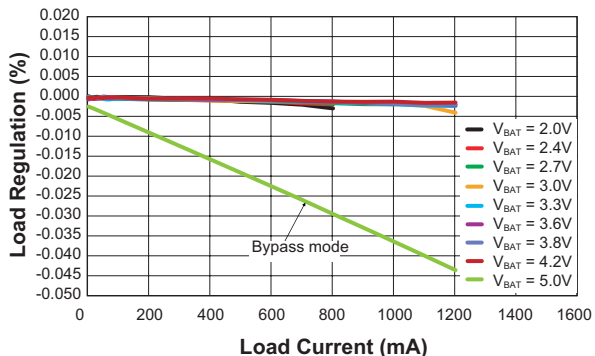

Main SD Load Regulation vs. Output Current
(V_{PVM} = V_{BAT}; V_{MSD} = 3.3V; L = 3.3μH; C_{OUT} = 4.7μF)

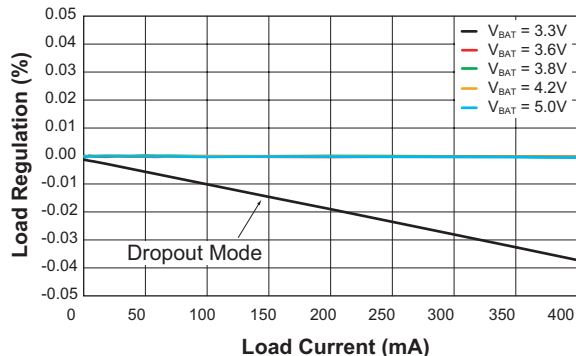

Seven-Channel PMU for Digital Still Cameras

Typical Characteristics

Main SU Load Regulation vs. Output Current
($V_{MSU} = 3.3V$; $L = 2.2\mu H$; $C_{OUT} = 10\mu F$)

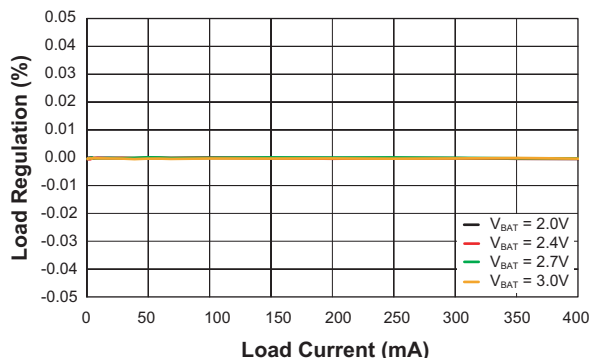

SD1 Load Regulation vs. Output Current
($V_{PVSD1} = V_{BAT}$; $V_{SD1} = 2.5V$; $L = 2.2\mu H$; $C_{OUT} = 10\mu F$)

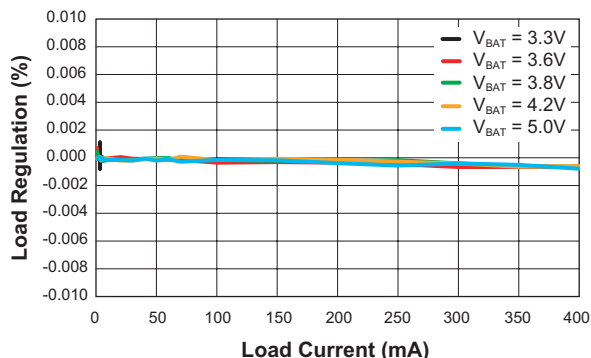

SD2 Load Regulation vs. Output Current
($V_{PVSD2} = V_{BAT}$; $V_{SD2} = 1.8V$; $L = 2.2\mu H$; $C_{OUT} = 4.7\mu F$)

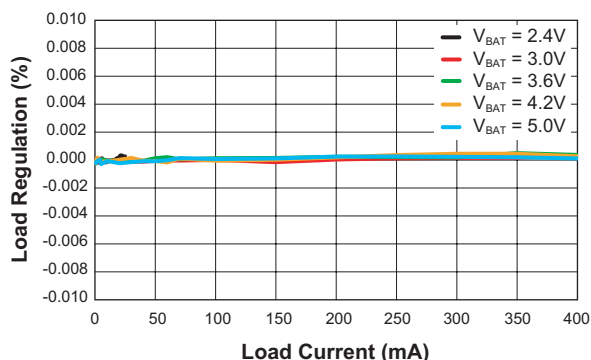

SD2 Load Regulation vs. Output Current
($V_{SD2} = 1.2V$; $L = 2.2\mu H$; $C_{OUT} = 4.7\mu F$)

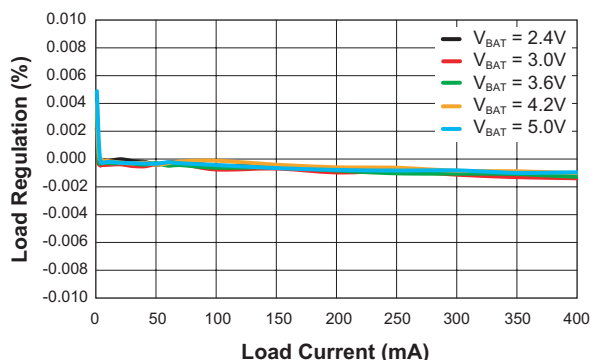

AUX2 Load Regulation vs. Output Current
($V_{AUX2} = +15V$; $L = 4.7\mu H$; $C_{OUT} = 4.7\mu F$)

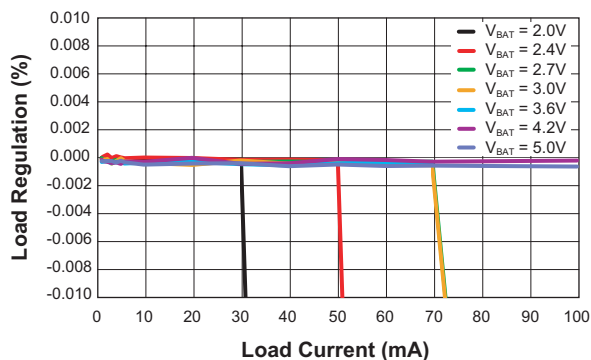

AUX3 Load Regulation vs. Output Current
($V_{AUX3} = -7.5V$; $L = 4.7\mu H$; $C_{OUT} = 4.7\mu F$)

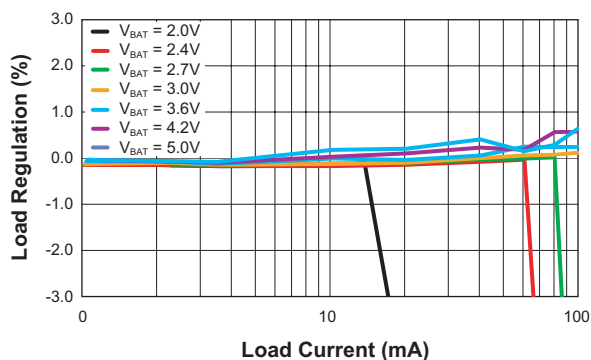

Typical Characteristics

SU Output Ripple

($V_{BAT} = 3.6V$; $V_{SU} = 5V$; $C_{OUT} = 22\mu F$; 10mA Load)

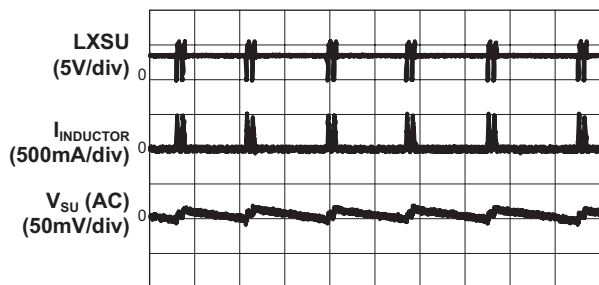

Time (10µs/div)

SU Output Ripple

($V_{BAT} = 3.6V$; $V_{SU} = 5V$; $L = 2.2\mu H$; $C_{OUT} = 22\mu F$; 200mA Load)

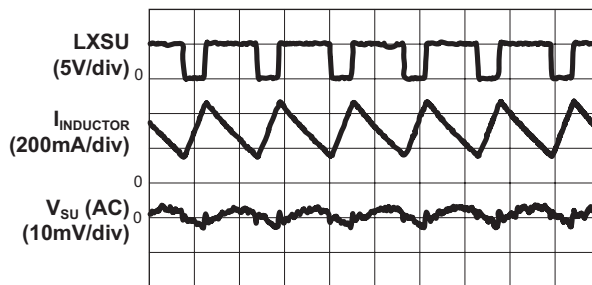

Time (400ns/div)

Main SU Output Ripple

($V_{BAT} = 2.4V$; $V_{MSU} = 3.3V$; $L = 2.2\mu H$; $C_{OUT} = 10\mu F$; 10mA Load)

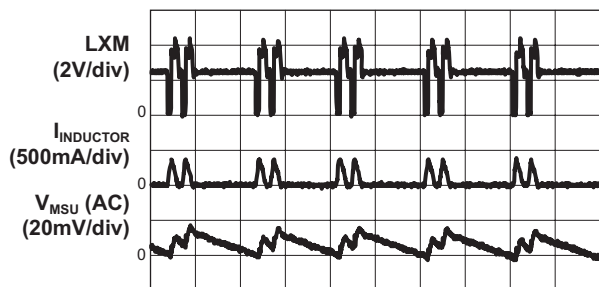

Time (4µs/div)

Main SU Output Ripple

($V_{BAT} = 2.4V$; $V_{MSU} = 3.3V$; $L = 2.2\mu H$; $C_{OUT} = 10\mu F$; 200mA Load)

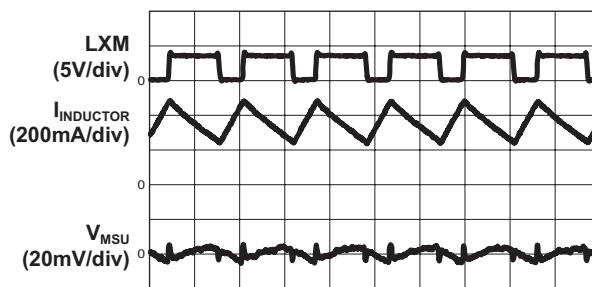

Time (400ns/div)

Main SD Output Ripple

($V_{PVM} = V_{BAT} = 4.2V$; $V_{MSD} = 3.3V$; $L = 3.3\mu H$; $C_{OUT} = 4.7\mu F$; 10mA Load)

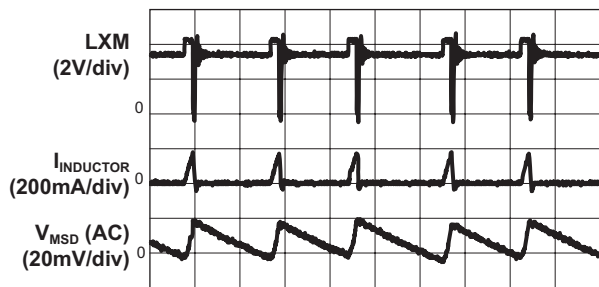

Time (4µs/div)

Main SD Output Ripple

($V_{PVM} = V_{BAT} = 4.2V$; $V_{MSD} = 3.3V$; $L = 3.3\mu H$; $C_{OUT} = 4.7\mu F$; 200mA Load)

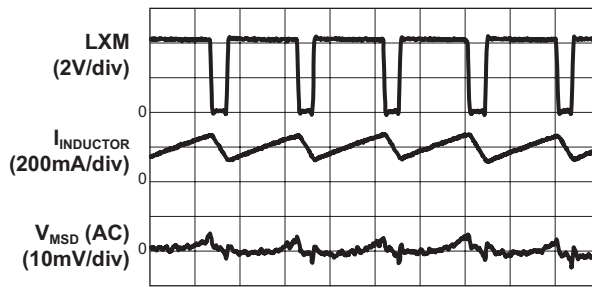

Time (4µs/div)

Typical Characteristics

SD Output Ripple

($V_{PSD2} = V_{BAT} = 3.6V$; $V_{SD2} = 1.8V$; $L = 2.2\mu H$;
 $C_{OUT} = 4.7\mu F$; 10mA Load)



Time (2µs/div)

SD Output Ripple

($V_{PVS2} = V_{BAT} = 3.6V$; $V_{SD2} = 1.8V$; $L = 2.2\mu H$;
 $C_{OUT} = 4.7\mu F$; 200mA Load)

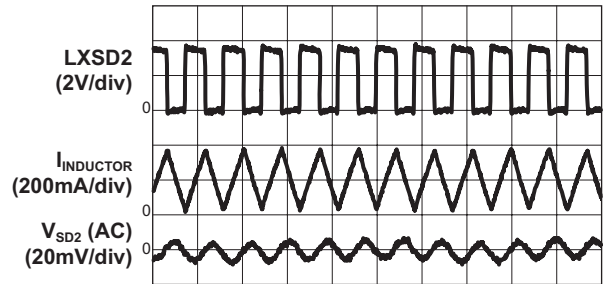

Time (800ns/div)

AUX1 Output Ripple

($V_{BAT} = 3.6V$; $C_{OUT} = 1\mu F$; $L = 4.7\mu H$;
4 WLED with 30mA LED Current)

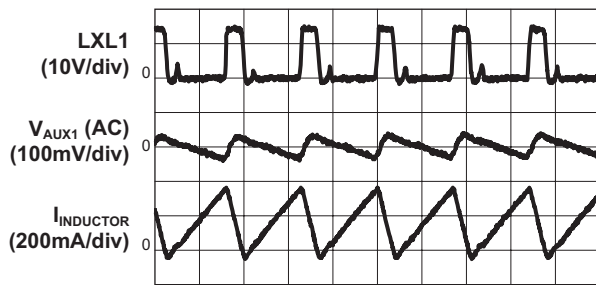

Time (400ns/div)

AUX2 Output Ripple

($V_{BAT} = 3.6V$; $V_{AUX2} = 15V$; $C_{OUT} = 4.7\mu F/25V$;
 $L = 4.7\mu H$; 20mA Load)

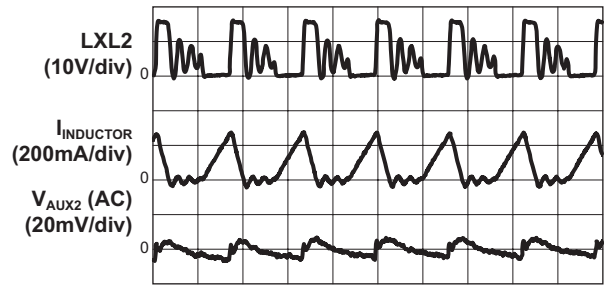

Time (400ns/div)

AUX3 Output Ripple

($V_{BAT} = 3.6V$; $V_{AUX3} = -7.5V$; $C_{OUT} = 4.7\mu F/10V$;
 $L = 4.7\mu H$; 20mA Load)

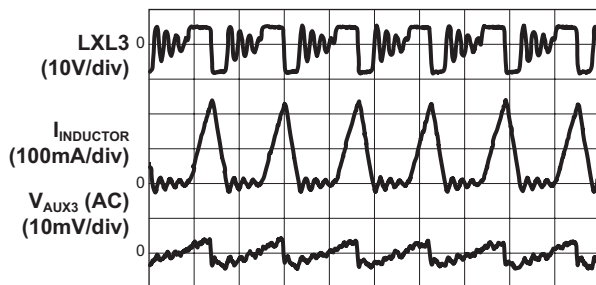

Time (400ns/div)

SU Channel Load Transient Response

($V_{BAT} = 3.6V$; $V_{SU} = 5V$; $L = 2.2\mu H$; $C_{OUT} = 22\mu F$;
Transient Slew Rate 0.1A/µs)

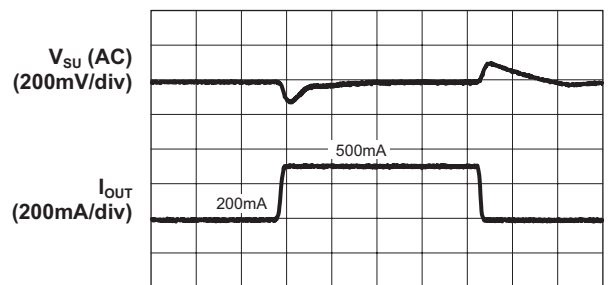

Time (40µs/div)

Seven-Channel PMU for Digital Still Cameras

Typical Characteristics

Main SD Load Transient Response

($V_{BAT} = V_{PVM} = 3.6V$; $V_{MSD} = 3.3V$; $L = 3.3\mu H$;
 $C_{OUT} = 4.7\mu F$; Transient Slew Rate = $0.1A/\mu s$)

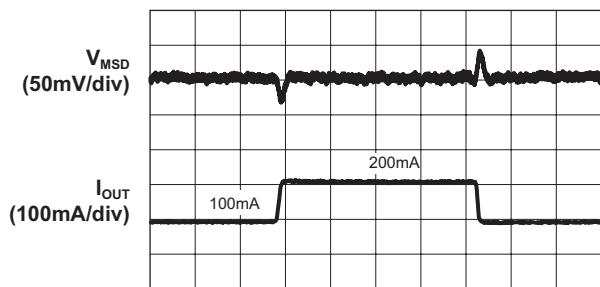

Time (40 μs /div)

SD1 Load Transient Response

($V_{BAT} = V_{PVSD1} = 3.6V$; $V_{SD1} = 2.5V$; $L = 2.2\mu H$;
 $C_{OUT} = 10\mu F$; Transient Slew Rate = $0.1A/\mu s$)

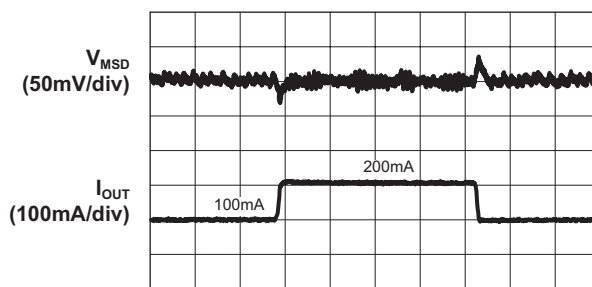

Time (40 μs /div)

SD2 Load Transient Response

($V_{BAT} = V_{PVSD2} = 3.6V$; $V_{SD2} = 1.8V$; $L = 2.2\mu H$;
 $C_{OUT} = 4.7\mu F$; Transient Slew Rate = $0.1A/\mu s$)

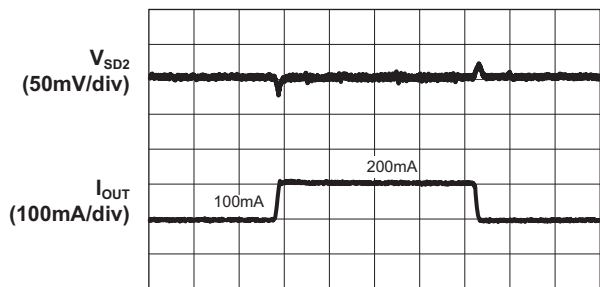

Time (40 μs /div)

AUX2 Load Transient Response

($V_{BAT} = 3.6V$; $V_{AUX2} = 15V$; $L = 4.7\mu H$;
 $C_{OUT} = 4.7\mu F/25V$; Transient Slew Rate = $0.1A/\mu s$)

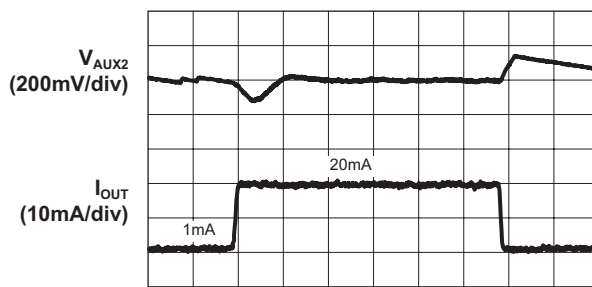

Time (40 μs /div)

AUX3 Load Transient Response

($V_{BAT} = V_{PVL3} = 3.6V$; $V_{AUX3} = -7.5V$; $L = 4.7\mu H$;
 $C_{OUT} = 4.7\mu F/10V$; Transient Slew Rate = $0.1A/\mu s$)

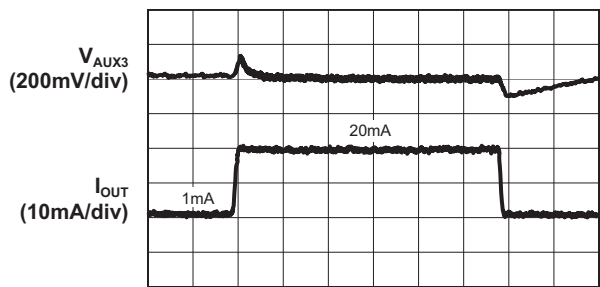

Time (40 μs /div)

Minimum Start-up Voltage vs. Load Current ($V_{SU} = 5V$)

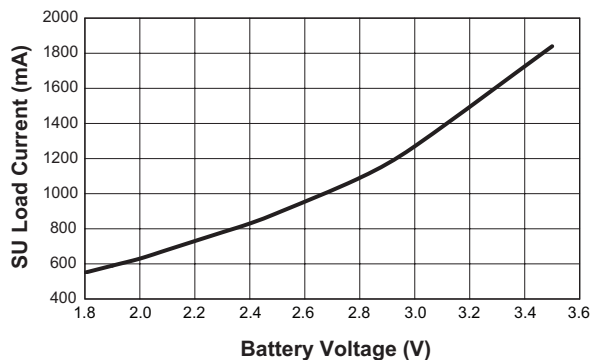

AAT2610

Seven-Channel PMU for Digital Still Cameras

Typical Characteristics

SU Start-up

($V_{BAT} = 3.6V$; $V_{SU} = 5V$; $C_{OUT} = 22\mu F$; 1A Load)

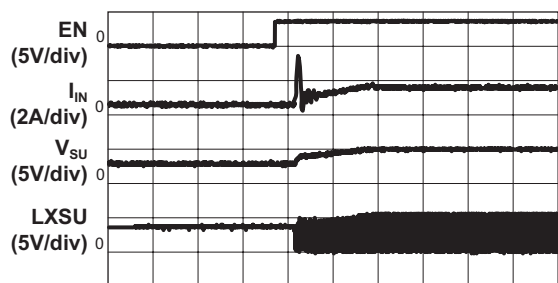

Time (200 μs /div)

Line Transient Response

($V_{BAT} = 3.6V$ to $4.2V$; $V_{SU} = 5V$; $L = 2.2\mu H$; $C_{OUT} = 22\mu F$; 200mA Load)

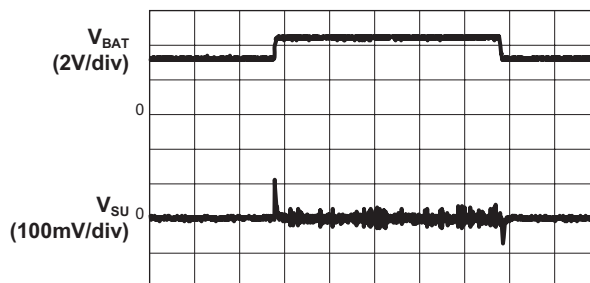

Time (1ms/div)

SU Start-up Sequence

($V_{BAT} = 3.6V$; All Seven Channels Enabled; $V_{SU} = 5V$; $SU = 10mA$ Load)

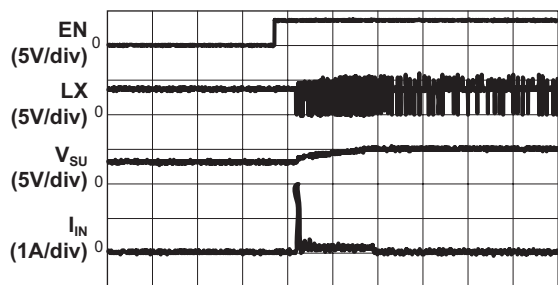

Time (200 μs /div)

AUX1, AUX2, AUX3 Start-up Sequence

($V_{BAT} = 3.6V$; AUX1 = 4 WLEDs; $V_{SU} = 5V$; $V_{AUX2} = 15V$; $V_{AUX3} = -7.5V$; AUX2, AUX3 = 10mA Load)

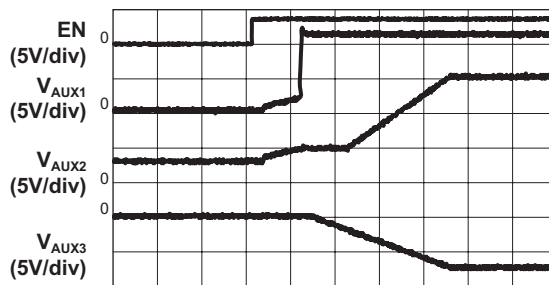

Time (400 μs /div)

MSD, SD1, SD2 Startup Sequence

($V_{BAT} = 3.6V$; $V_{SU} = 5V$; $V_{MSD} = 3.3V$; $V_{SD2} = 1.8V$; 10mA Load)

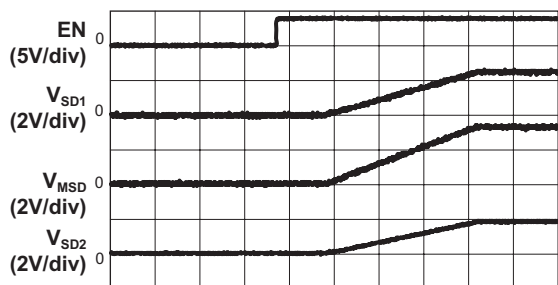

Time (400 μs /div)

MSU, SD1, SD2 Startup Sequence

($V_{BAT} = 1.8V$; $V_{SU} = 5V$; $V_{MSU} = 3.3V$; $V_{SD1} = 2.5V$; $PVSD1 = PVSD2 = PVSU$; 10mA Load)

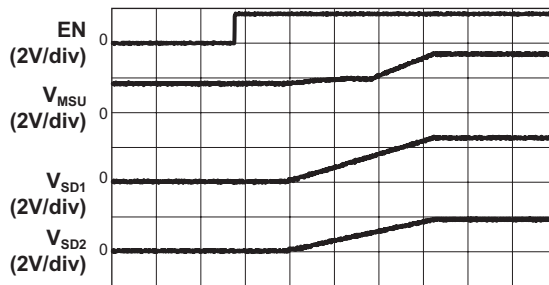

Time (400 μs /div)

Typical Characteristics

Reference Voltage vs. Temperature

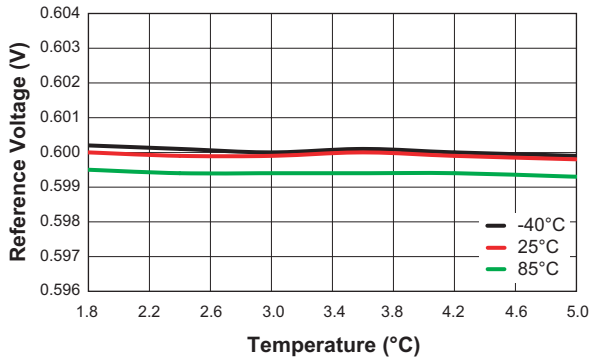

Switching Frequency vs. Temperature

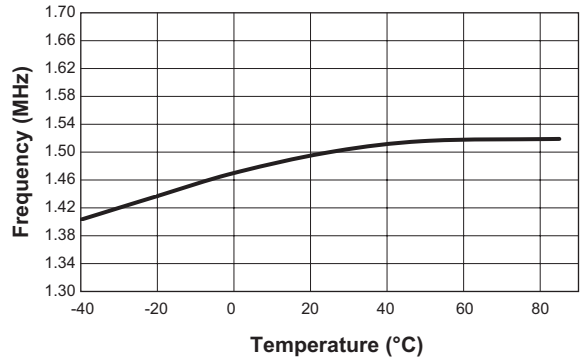

Shutdown Current vs. Input Voltage

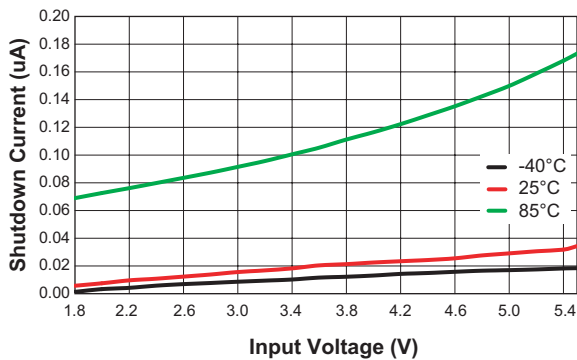

Input Current vs. Input Voltage
(Only SU Enabled, $V_{SU} = 5V$, $L = 2.2\mu H$, $C_{OUT} = 22\mu F$)

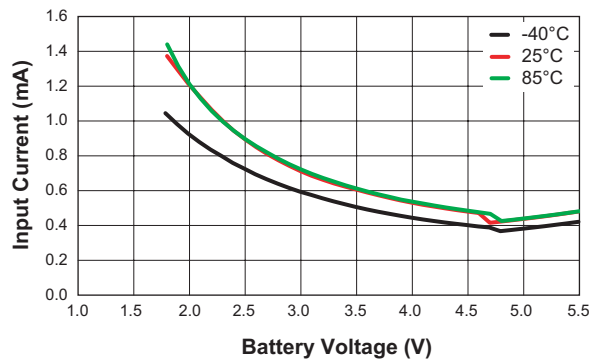

AAT2610

Seven-Channel PMU for Digital Still Cameras

Functional Block Diagram

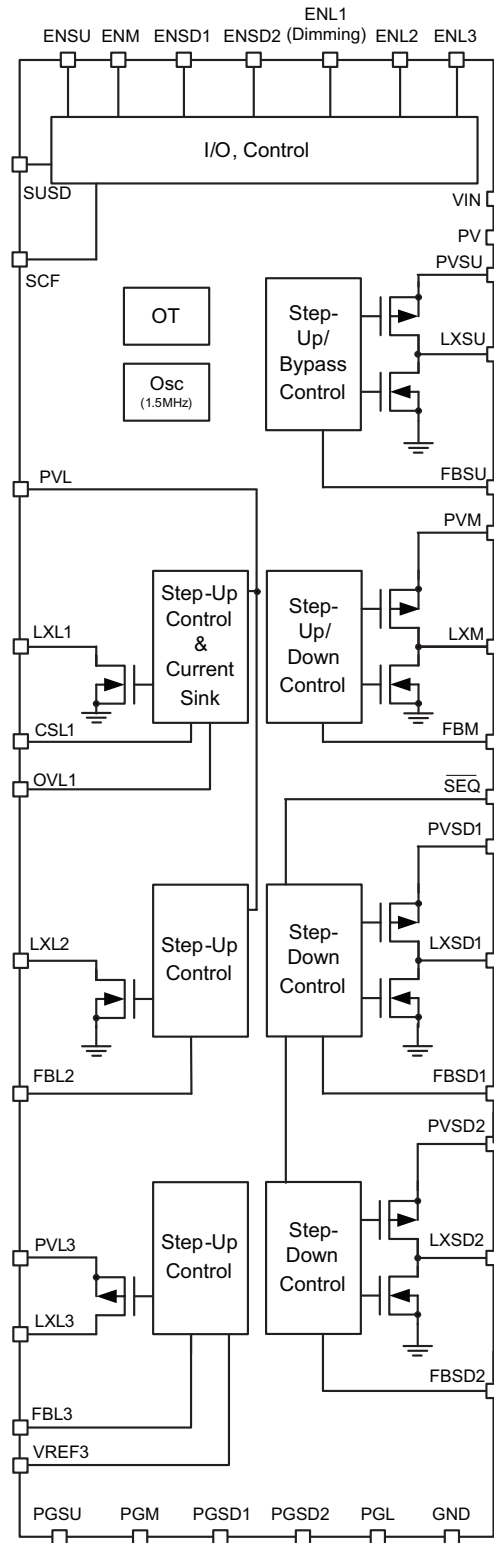

Seven-Channel PMU for Digital Still Cameras**Functional Description**

The AAT2610 PMIC is targeted for single cell Li-ion battery or dual cell Alkaline battery applications. It includes seven integrated step-up and step-down converters, including one synchronous step-up converter (SU), two synchronous step-down converters (SD1, SD2), one synchronous step-up or step-down converter (Main), two non-synchronous step-up converters (AUX1, AUX2) and one non-synchronous buck-boost (inverting) converter (AUX3).

The SU converter is the key channel. Its output powers all internal control and reference circuits when the output voltage is above 2.7V. The AUX1 converter is specially designed for 1 to 6 white LED serial backlight applications. Its current sink pin (CSL1) is suitable to control WLED current to up to 30mA. AUX3 is a transformerless inverting converter which controls the internal P-channel MOSFET to regulate negative voltage.

The AAT2610 uses a fixed-frequency peak current control architecture. Light load mode is used to enhance light load efficiency. Compensation is integrated to reduce the number of external components and achieve excellent transient response and load and line regulation.

The ideal 1.5MHz switching frequency allows the use of smaller output filter components for improved power density, reduced external component size, and optimized output voltage ripple. The output voltages can be programmed by an external divider.

The AAT2610 has seven separate enable pins to control each converter's startup. A 1.4ms startup delay is employed to guarantee that the key SU converter is already in regulation and the internal control and the reference have been normally biased before the other six converters start up.

Synchronous Step-Up DC to DC Converter

The AAT2610 has one synchronous step-up DC-DC converter. It utilizes internal power MOSFETs to achieve high efficiency over the full load current range. The external feedback can program the output voltage between 3.0V to 5.5V. Its "bypass" mode automatically connects the input to the output when the input voltage is higher than the bypass mode threshold. In shutdown, the enable pin (ENSU) is pulled low, the SU converter output is equal to the input voltage minus a voltage drop across the parasitic body diode, and all other channels are shut down regardless of their enable setting.

Start-Up

The AAT2610's major control circuitries adopt power from the SU converter output and do not function at less than 2.7V. To ensure the PMIC can start up at V_{IN} as low as 1.8V, the step-up converter employs a startup oscillator with a typical 200kHz frequency. The startup oscillator drives the internal N-channel MOSFET at LXSU until the SU converter output voltage reaches 2.7V, at which point the current-mode PWM circuitry takes over. A startup current limit (750mA) and NMOSFET off time (700ns) decrease the startup inrush current. At low input voltages, the AAT2610 may have difficulty starting up with heavy loads.

Under-Voltage Lockout

Independent UVLO (Under-Voltage Lockout) circuitry guarantees the sufficient input power and proper operation of all internal circuitry. When input voltage at V_{IN} rises above 1.8V, the AAT2610 leaves UVLO status and enters the startup process. Once in regulation, the V_{IN} power can be as low as 1.6V before the AAT2610 enters UVLO status.

Bypass Mode

When the SU converter input voltage increases above the bypass mode threshold (typically 4.75V), the step-up converter enters "bypass" mode, which automatically connects the input to the output. In this mode, P-channel synchronous MOSFET is always ON and N-channel MOSFET is always off. The output voltage follows input voltage in the mode and overload protection is disabled.

Synchronous Step-Up/Step-Down DC to DC Converter

The AAT2610 has one synchronous step-up/step-down DC-DC converter which is ideally designed for 2AA/Li-ion applications. The SUSD pin is used to set the operation mode. When SUSD is set to logic high, the step-up converter setting is selected. N-channel switch transistor current is sensed for current loop control to regulate the output over the complete load range; when SUSD is pulled low, the step-down converter type is set and the P-channel switch transistor current is sampled for the current control loop. In both converter types, soft-start is employed to suppress the startup inrush current and eliminate the output voltage overshoot.

In shutdown with the enable pin (ENM) pulled low, if the step-down converter is selected, the converter is forced into a non-switching state and the output voltage drops

Seven-Channel PMU for Digital Still Cameras

to zero. When the step-up converter is selected, the output voltage is equal to the input voltage minus a voltage drop across the parasitical body diode. If true load disconnection is required, an external PMOSFET controlled by SEQ can be adopted.

Synchronous Step-Down DC to DC Converter

The AAT2610 has two synchronous step-down DC-DC converters. Their output voltages can be programmed from 0.6V to V_{IN} by an external resistor divider.

At dropout, the converter's duty cycle equals 100% and the output voltage tracks the input voltage minus the voltage drop across the P-channel MOSFET. At low input supply voltage, the $R_{DS(ON)}$ of the P-channel MOSFET increases, and the efficiency of the converter decreases.

The two step-down converters adopt soft-start to eliminate output voltage overshoot when the enable or input voltage is applied. When the ENSD1 and ENSD2 are pulled low, the outputs of the two SD converters are down to zero and its shutdown current is below 1 μ A.

Non-Synchronous Step-Up and Buck/Boost (Inverting) DC to DC Converters

Two non-synchronous step-up converters are targeted for LCD backlight and CCD positive loads. The controllers regulate the output voltage by modulating the pulse width of the internal NMOSFET. External schottky diode and power inductor are required to set up the boost. The output voltage can be programmed from 5V to 20V by external divider.

Auxiliary 1 is ideally designed for driving typical 4 serial white LEDs. The maximum current flowing through the WLED string is sensed at CSL1 and set to 30mA by the internal ballast resistor with $\pm 10\%$ accuracy. The industry standard PWM (Pulse Width Modulation) controlling technology is adopted to program the WLED current. Applying a 10% ~100% duty cycle PWM signal with the frequency range 1kHz to 30kHz at ENL1 can get 2mA to 30mA WLED current. If an open circuit occurs, the internal over-voltage protection circuit prevents damage to the converter within 67ms, then shuts down all channels.

Auxiliary 2 is designed for +15V CCD bias. Soft-start is adopted to eliminate the output voltage overshoot and decrease the effect on the input voltage.

Auxiliary 3 is non-synchronous buck-boost (inverting) DC to DC converter which is targeted for negative CCD

loads with low noise. Soft-start is adopted to limit the inrush current at startup.

Light Load Mode and Normal PWM Control

The AAT2610 uses light load mode to enhance the efficiency at light load. In light load mode, if the error amplifier output signal is lower than a given level at a certain clock point, the switch pulse is skipped to reduce dominant switching losses.

In normal PWM mode to the buck converter, the current through the P-channel (high side) is sensed for current loop control. The P-channel current limit is used to prevent internal power PMOSFET overstress or damage by the high power. To the boost converter, the current through the N-channel (low side) is sensed for the control loop and its current limit also protects the main MOSFET.

The error amplifier programs the current mode loop for the necessary peak switch current to force a constant output voltage for all load and line conditions. The internal fixed slope compensation is employed to eliminate the sub-harmonic oscillation and keep regulation stable when the duty cycle is over 50%.

Fault Protection**Short-Circuit and Overload Protection**

When any of the converters' output voltage is lower than the programmed value for a certain period of time (100,000 clock cycles, typically 66.7ms), the central control circuits treat it as an overload situation; all seven channels will be turned off and SCF will be pulled low until the IC is restarted either by SU enable pin (ENSU) reset or re-application of the input voltage. During overload period, the peak current limit prevents the main switch (NMOSFET of step-up converter and PMOSFET of step-down converter) from overstress and damage, and also avoids saturation of the external inductor. For synchronous step-up (SU) channels, overload protection function is disabled in "bypass" mode.

Over-Temperature Protection

Thermal protection completely disables power MOSFET switching when internal power dissipation becomes excessive. Only reference and internal clock are still active in this condition. Once the over-temperature condition is removed, the output voltages automatically recover. The junction over-temperature threshold is 140°C with 15°C of hysteresis.

Seven-Channel PMU for Digital Still Cameras

Application Information

Setting the Output Voltage

Step-Down Converter

An external resistor divider is used to program the step-down converter's output voltage from 0.6V to V_{IN} . Resistors R1 and R2 in Figure 1 program the output to regulate at voltages higher than 0.6V. To limit the bias current required for the external feedback resistor string while maintaining good noise immunity, the suggested value for R2 is 59k Ω . Although a larger value will further reduce quiescent current, it will also increase the impedance of the feedback node, making it more sensitive to external noise and interference. Table 1 summarizes the resistor values for various output voltages with R2 set to 59k Ω .

The AAT2610 has 3 step-down converters: SD1, SD2 and Main SD. The external resistor sets the output voltage according to the following equations:

$$V_{OUT} = 0.6V \cdot \left(1 + \frac{R1}{R2}\right)$$

$$R1 = \left(\frac{V_{OUT}}{0.6V} - 1\right) \cdot R2$$

Table 1 shows the resistor selection for different output voltage settings. 1% accuracy metal-film resistors are strongly recommended to get accurate output voltages.

V_{OUT} (V)	R2 = 59k Ω R1 (k Ω)
1.2	59
1.5	88.7
1.8	118
2.5	187
3.0	237
3.3	267

Table 1: Resistor Select for Step-Down Converter Output Voltage Setting.

Step-Up Converter

Similar to the step-down converter, the step-up regulators also use an external resistor divider to program the output voltage. The AAT2610 has 4 step-up converters: SU, Main SU, AUX1 and AUX2. The equation for external resistors setting the output voltage is same as for the step-down converter. Figure 2 shows the synchronous (SU and Main SU) and non-synchronous (AUX1 and AUX2) step-up converter application connections. Table 2 shows resistor selection for different output voltage settings. 1% accuracy metal-film resistors are strongly recommended to get accurate output voltages.

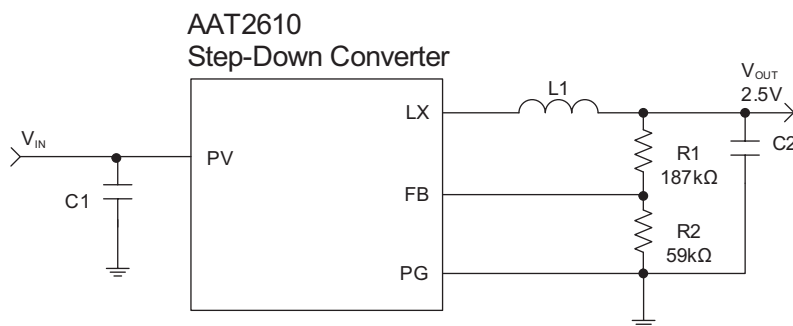

Figure 1: Step-Down Converter with Output Voltage Programmed by External Resistor Divider.

Seven-Channel PMU for Digital Still Cameras

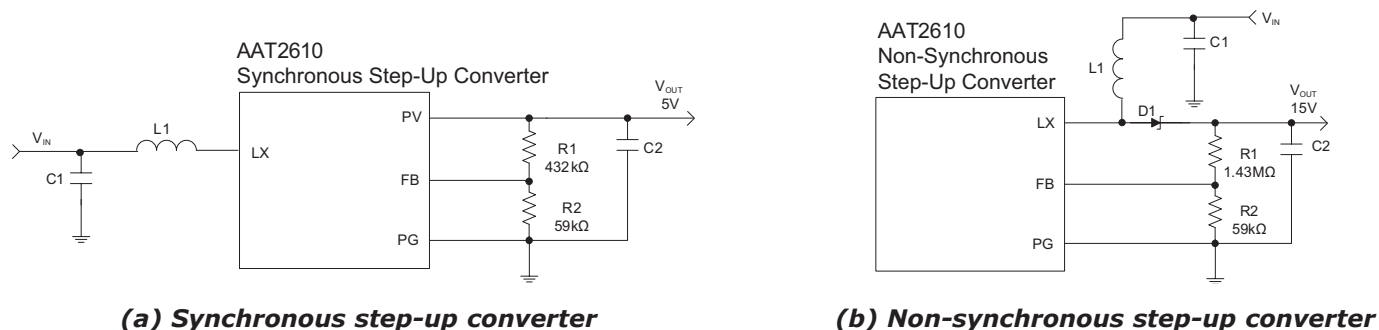

Figure 2: Step-Up Converter with Output Voltage Programmed by External Resistor Divider.

V_{OUT} (V)	$R2 = 59k\Omega$ $R1$ (k Ω)
3.3	267
3.8	316
4.2	357
5.0	432
15	1420

Table 2: Resistor Select for Step-up Converter Output Voltage Setting.

Buck-Boost (Inverting) Converter

The AAT2610 has one inverting converter, AUX3. Figure 3 shows an AUX3 application circuit. Its programmed output voltage can be set by the following equations:

$$V_{OUT} = \frac{-0.6V}{R2} \cdot R1$$

$$R1 = \frac{V_{OUT}}{-0.6V} \cdot R2$$

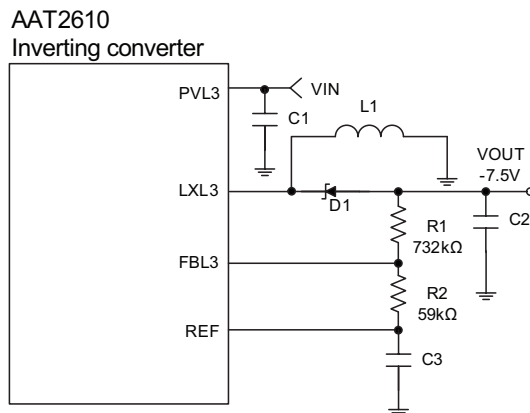

Figure 3: Buck/Boost (Inverting) Converter with Output Voltage Programmed by External Resistor Divider.

Inductor Selection

The AAT2610 can utilize small surface mount inductors due to its fast 1.5MHz switching frequency. Optimized inductor values for each channel keeps the seven channels stable, and achieves reduced output voltage ripple at smaller output capacitor size. See Table 3 for recommended inductors for each channel. A greater inductance value will allow greater output current capability by reducing inductor ripple current. Increasing the inductance above 4.7 μ H will increase size to get enough saturation current rating. The following equations show the minimum saturation current of the selected inductors.

Seven-Channel PMU for Digital Still Cameras

Manufacturer	Part Number	Inductance (μH)	Max DC Current (A)	DCR (mΩ)	Size (mm) LxWxH	Type	Suit for Channel
Sumida	CDRH4D22/HP	2.2	3.2	35.4	4.5x4.5x2.4	shielded	SU
	CDRH8D28	2.5	4.5	12	8.3x8.3x3	shielded	SU
	CDRH2D09	2.5	0.53	120	3.2x3.2x1.0	shielded	Main SD, SD1, SD2
		2.2	0.60	115	3.2x3.2x1.0	shielded	Main SD, SD1, SD2
		1.8	0.65	105	3.2x3.2x1.0	shielded	SD2
	CDRH2D09C	3.3	0.50	139	3.2x3.2x1.0	shielded	Main SU
	CDRH2D14	4.7	1.0	135	3.2x3.2x1.55	shielded	AUX1, AUX2, AUX3
	CDRH2D11/HP	4.7	0.75	190	3.2x3.2x1.2	shielded	
	CDRH2D18/HP	2.2	1.6	48	3.2x3.2x2.0	shielded	Main SD, SD1, SD2
CDRH2D18/HP	4.7	1.2	110	3.2x3.2x2.0	shielded	AUX1, AUX2, AUX3	
Cooper	SD3110	2.2	1.0	149	3.1x3.1x1.0	shielded	Main SD, SD1, SD2
	SD3110	3.3	0.81	195	3.1x3.1x1.0	shielded	Main SU, SD1, SD2
	SD3112	4.7	0.80	246	3.1x3.1x1.2	shielded	AUX1, AUX2, AUX3
Murata	LQH32PN2R2NNO	2.2	1.6	76	3.2x2.5x1.55	unshielded	Main SD, SD1, SD2
	LQH32PN3R3NNO	3.3	1.2	120	3.2x2.5x1.55	unshielded	Main SU, SD1, SD2
	LQH32PN4R7NNO	4.7	1.0	180	3.2x2.5x1.55	unshielded	AUX1, AUX2, AUX3

Table 3: Suggested Inductor Selection Information.

To step-up converter,

$$I_{L_SAT} > \frac{I_{OUT_MAX}}{1-D} + \frac{V_{IN} \cdot D}{2 \cdot f \cdot L}$$

Among it,

$$D = 1 - \frac{V_{IN}}{V_{OUT}}$$

To step-down converter,

$$I_{L_SAT} > I_{OUT_MAX} + \frac{(V_{IN} - V_{OUT}) \cdot D}{2 \cdot f \cdot L}$$

Among it,

$$D = \frac{V_{OUT}}{V_{IN}}$$

Input and Output Capacitor Selection

Low ESR (equivalent series resistance) capacitors should be used to minimize output voltage ripple. Multilayer ceramic capacitors are an excellent choice as they have extremely low ESR and are available in small footprints. The following equations show the minimum capacitance under the required output voltage ripple for step-up and step-down converters. In actual application, capacitance usually decreases a lot as its DC bias increases. So when

selected output capacitors, not only calculating the output capacitor minimum values are necessary according to the equations, but the actual capacitance must be carefully considered to get expected output voltage ripple. X5R and X7R dielectric materials of ceramic capacitors are preferred for their ability to maintain capacitance over wide voltage and temperature ranges.

To step-up converter,

$$C_{OUT} \geq \frac{D \cdot I_{OUT}}{\Delta V_{OUT} \cdot f}$$

To step-down converter,

$$C_{OUT} \geq \frac{V_{OUT}}{8 \cdot f^2 \cdot L \cdot \Delta V_{OUT}} \cdot (1-D)$$

For example, to step-up converter, when $V_{IN} = 3.6V$, $I_{OUT} = 900mA$, and $f = 1.5MHz$, output ripple requires below 30mV. According to the equation above, the calculated C_{OUT} should be higher than 5.6μF. If use Sumida 22μF/6.3V 0805 ceramic capacitor, its capacitance at 5V DC bias is 8.0μF which can meet the ripple requirements.

Input capacitors for input decoupling should be located as close as possible to the device to get better input power filtering effect. Select 1μF to 4.7μF X5R or X7R ceramic capacitors for the inputs. Table 4 shows suggested capacitor part numbers.

Seven-Channel PMU for Digital Still Cameras

Manufacturer	Value (μF)	Voltage (V)	Case Size	Part Number	Channel / Capacitor Position
Murata	1	25	0603	GRM188R61E105K	AUX1 / output
	1	10	0603	GRM185R61A105K	SD1, SD2, AUX1, AUX2, AUX3 / input
	3.3	10	0603	GRM188R61A335K	AUX3 / output
	4.7	25	0805	GRM21BR61E475K	AUX2 / output
	4.7	6.3	0603	GRM188R60J475K	SU, Main / input Main SD, SD1, SD2 / output
	10	6.3	0805	GRM219R60J106KE19	Main SU, SD1, SD2
	22	6.3	0805	GRM21BR60J226M	SU, Main SU / output

Table 4: Suggested Input and Output Capacitor Selection Information.

Output Diode

A Schottky diode is suitable in the three non-synchronous step-up channels for its low forward voltage and fast recovery time. 20V rated Schottky diodes are recommended for outputs less than 10V, while 30V rated Schottky diodes are recommended for outputs greater than 10V. Table 5 shows suggested diode part numbers.

Using SEQ for Power Sequence

Power sequence delay is designed to connect the loads to Main channel output after its normal startup. Use the SEQ output signal to control an external PMOSFET connected between Main output and loads. The SEQ output is high impedance lasted for 10ms when startup, then pulled low after both the SD1 and SD2 converters completed soft-start and achieved output regulation. When SD1 and SD2 are disabled, SEQ is also pulled low after 10ms when Main channel achieves regulation.

Using SCF for Full-Load Startup

SCF goes high (high impedance, open drain) when overload protection occurs. Under normal operation, SCF pulls low. It can be used to drive a P-channel MOSFET switch that turns off the load of a selected supply in the event of an overload. Or, it can remove the load until the supply reaches regulation, effectively allowing full load startup.

Thermal Considerations

Thermal design is an important aspect of power management IC applications and PCB layout. The AAT2610 TQFN55-40L package can provide up to 2W of power dissipation when it is properly soldered onto a printed circuit board with thermal vias. The package has a maximum thermal resistance of 25°C/W. The maximum power dissipation in a given ambient condition can be calculated:

$$P_{D(MAX)} = \frac{(T_{J(MAX)} - T_A)}{\theta_{JA}}$$

Where:

$P_{D(MAX)}$ = Maximum Power Dissipation (W)

θ_{JA} = Package Thermal Resistance (°C/W)

$T_{J(MAX)}$ = Maximum Device Junction Temperature (°C)
[150°C]

T_A = Ambient Temperature (°C)

The power dissipation for the synchronous buck channel in CCM (Continuous Conduction Mode) can be calculated by the following equation:

$$P_{Syn-BUCK} = I_{OUTBUCK}^2 \cdot \left(R_{DS(ON)P} \cdot \frac{V_{INBUCK}}{V_{OUTBUCK}} + R_{DS(ON)N} \cdot \left[1 - \frac{V_{INBUCK}}{V_{OUTBUCK}} \right] \right)$$

Where:

$P_{Syn-BUCK}$ = Synchronous Buck Channel Power Dissipation

$I_{OUTBUCK}$ = Synchronous Buck Channel Output Current

$V_{OUTBUCK}$ = Synchronous Buck Channel Output Voltage

V_{INBUCK} = Synchronous Buck Channel Input Voltage

$R_{DS(ON)x}$ = Synchronous Buck Channel PMOS or NMOS Drain-Source On Resistance

Seven-Channel PMU for Digital Still Cameras

The power dissipation for the synchronous boost channel in CCM can be calculated by the following equation:

$$P_{\text{Syn-BOOST}} = I_{\text{INBOOST}}^2 \cdot \left(R_{\text{DS(ON)P}} \cdot \frac{V_{\text{INBOOST}}}{V_{\text{OUTBOOST}}} + R_{\text{DS(ON)N}} \cdot \left[1 - \frac{V_{\text{INBOOST}}}{V_{\text{OUTBOOST}}} \right] \right)$$

Where:

$P_{\text{Syn-BOOST}}$ = Synchronous Boost Channel Power Dissipation

I_{INBOOST} = Synchronous Boost Channel Input Current

V_{OUTBOOST} = Synchronous Boost Channel Output Voltage

V_{INBOOST} = Synchronous Boost Channel Input Voltage

$R_{\text{DS(ON)x}}$ = Synchronous Boost Channel PMOS or NMOS Drain-Source On Resistance

The power dissipation for the non-synchronous boost channel can be calculated by the following equation:

$$P_{\text{Nonsyn-BOOST}} = I_{\text{INBOOST}}^2 \cdot \left(R_{\text{DS(ON)N}} \cdot \left[1 - \frac{V_{\text{INBOOST}}}{V_{\text{OUTBOOST}}} \right] \right)$$

Where:

$P_{\text{Nonsyn-BOOST}}$ = Non-Synchronous Boost Channel Power Dissipation

I_{INBOOST} = Non-Synchronous Boost Channel Input Current

V_{OUTBOOST} = Non-Synchronous Boost Channel Output Voltage

V_{INBOOST} = Non-Synchronous Boost Channel Input Voltage

$R_{\text{DS(ON)N}}$ = Non-Synchronous Boost Channel internal NMOS Drain-Source On Resistance

The power dissipation for the inverting channel in CCM can be calculated by the following equation:

$$P_{\text{Nonsyn-BUCKBOOST}} = I_{\text{IN-BUCKBOOST}}^2 \cdot R_{\text{DS(ON)P}} \cdot \frac{V_{\text{OUT-BUCKBOOST}}}{V_{\text{IN-BUCKBOOST}} - V_{\text{OUT-BUCKBOOST}}}$$

Where:

$P_{\text{Nonsyn-BUCKBOOST}}$ = Non-Synchronous Buck/Boost Channel Power Dissipation

$I_{\text{IN-BUCKBOOST}}$ = Non-Synchronous Buck/Boost Channel Input Current

$V_{\text{OUT-BUCKBOOST}}$ = Non-Synchronous Buck/Boost Channel Output Voltage

$V_{\text{IN-BUCKBOOST}}$ = Non-Synchronous Buck/Boost Channel Input Voltage

$R_{\text{DS(ON)P}}$ = Non-Synchronous Buck/Boost Channel internal PMOS Drain-Source On Resistance

Layout Guidance

When laying out the PC board, the following layout guideline should be followed to ensure proper operation of the AAT2610:

1. The exposed pad (EP) must be reliably soldered to the GND plane for better power dissipation. A PGND pad below EP is required.
2. The power traces, including the GND trace, the LX trace and the IN trace should be kept short, direct and wide to allow large current flow. Each inductor of the seven channels should be connected to the LX pins as short as possible. Use several VIA pads when routing between layers to decrease the conduction resistance.
3. The input filter capacitor of each channel should connect as closely as possible to IN (Pins 3, 8, 15, 29, 33 and 35) and GND (Pins 5, 6, 26, 27 and 37) to get good power filtering.
4. Keep the switching node, LX (Pins 4, 7, 25, 29, 34, 36 and 38), away from the sensitive FB node.
5. The feedback trace should be separate from any power trace and connect as closely as possible to the load point. Sensing along a high-current load trace will degrade DC load regulation. The external feedback resistors should be placed as closely as possible to the FB pin (Pin 1, 2, 9, 23, 30, 32 and 40) to minimize the length of the high impedance feedback trace.
6. It is recommended to connect the external feedback resistor divider to the signal ground (Pin 16). The signal ground and power ground should be connected at a single point to alleviate the power ground noise affecting the feedback voltage.
7. The resistance of the trace from the load return to PGND should be kept to a minimum. This will help to minimize any error in DC regulation due to differences in the potential of the internal signal ground and the power ground.

Figure 4 and 5 show the AAT2610 evaluation board layout with 4 layers.

AAT2610

Seven-Channel PMU for Digital Still Cameras

Manufacturer	Part Number	Rated Forward Current (A)	Non-Repetitive Peak Surge Current (A)	Rated Voltage (V)	Thermal Resistance (R _{θJA} , °C/W)	Package
ON Semi	MBR0530T	0.5	5.5	30	206	SOD-123
	MBR0520LT	0.5	5.5	20	206	SOD-123
Diodes	BAT42W	0.2	4	30	500	SOD-123
Zetex	ZHCS350	0.35	4.2	40	330	SOD-523
Central Semi	CMDSH2-3	0.2	1.0	30	500	SOD-323

Table 5: Suggested Schottky Diode Selection Information.

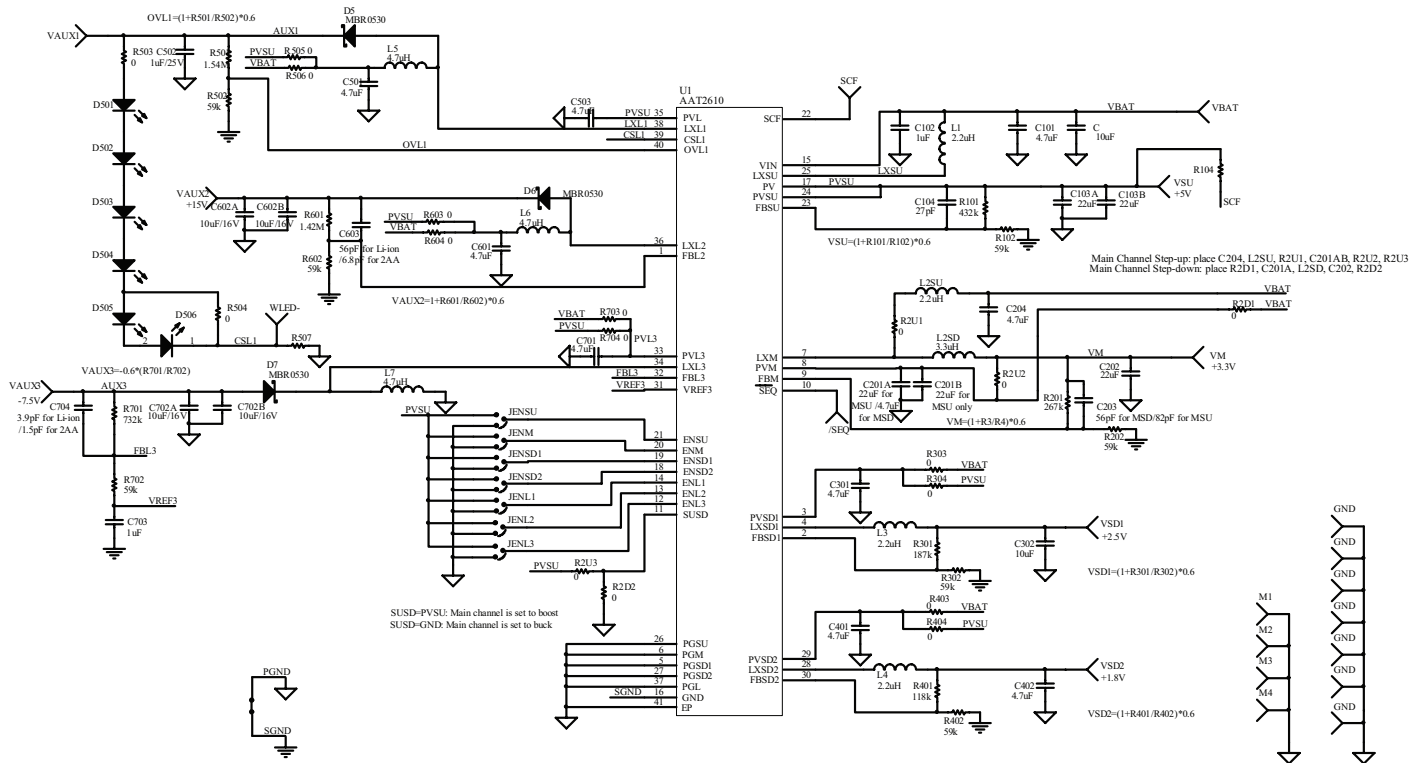

AAT2610

Seven-Channel PMU for Digital Still Cameras

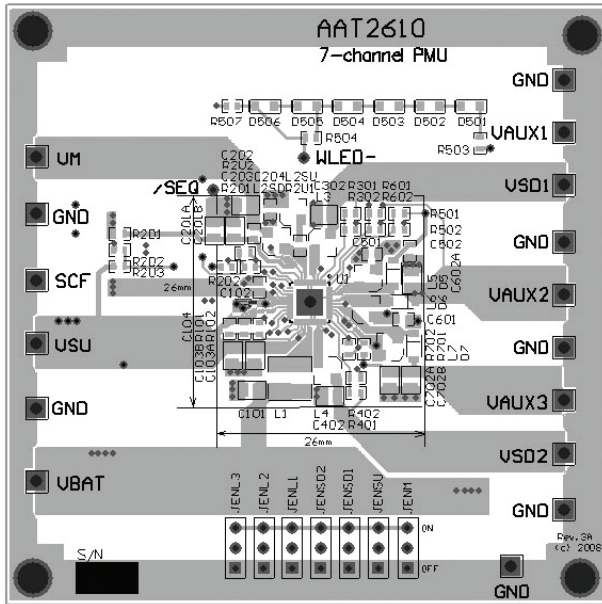

(a) Top Layer

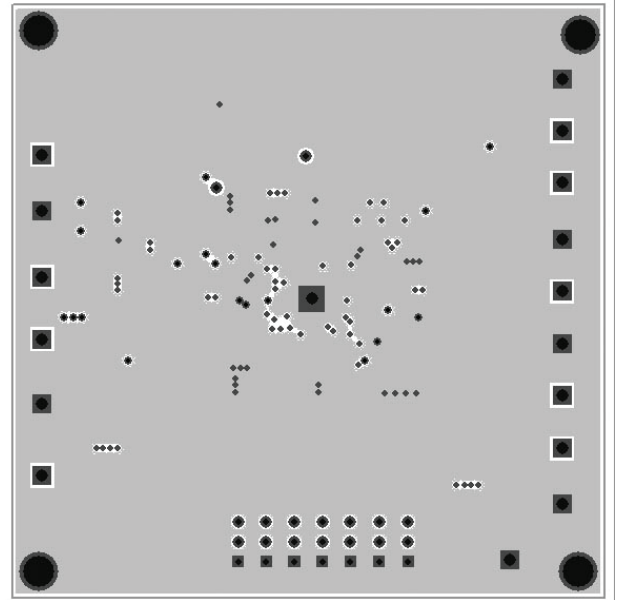

(b) Internal GND Layer

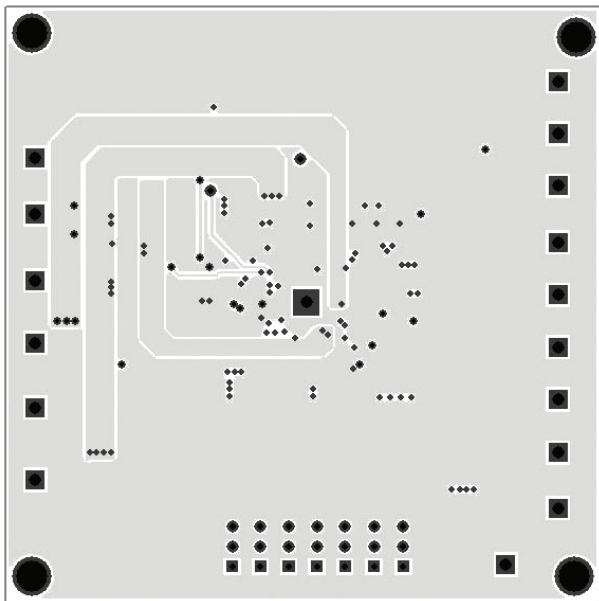

(c) Internal Signal Layer

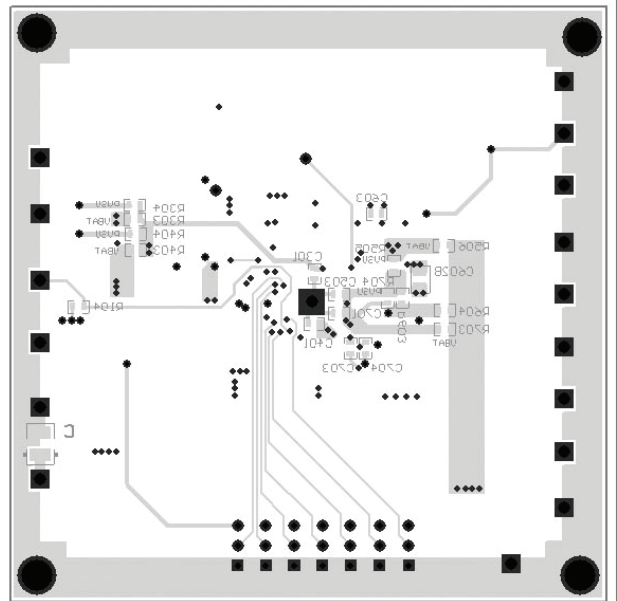

(d) Bottom Layer

Figure 5: AAT2610 Evaluation Board PCB Layout.

AAT2610**Seven-Channel PMU for Digital Still Cameras**

Designation	Part Number	Description	Manufacturer
IC Device			
U1	AAT2610IIC	Seven-Channel High Efficiency Power Management Unit	Skyworks
Capacitor			
C	T494B106M010AS	CAP TAN 10 μ F B 10V 20%	KEMET
C101	GRM21BR61C475K	CAP Ceramic 4.7 μ F 0805 X5R 16V 10%	Murata
C102, C703	GRM185R61A105K	CAP Ceramic 1 μ F 0603 X5R 10V 10%	
C103A, C103B, C202	GRM21BR60J226M	CAP Ceramic 22 μ F 0805 X5R 6.3V 20%	
C104	GRM1885C1H270J	CAP Ceramic 27pF 0603 C0G 50V 5%	
C201A, C301, C401, C402, C501, C503, C601, C701	GRM188R60J475K	CAP Ceramic 4.7 μ F 0603 X5R 6.3V 10%	
C203, C603	GRM1885C1H560J	CAP Ceramic 56pF 0603 C0G 50V 5%	
C302	GRM188R60J106M	CAP Ceramic 10 μ F 0603 X5R 6.3V 20%	
C303, C403	GRM1885C1H100J	CAP Ceramic 10pF 0603 C0G 50V 5%	
C502	GRM188R61E105K	CAP Ceramic 1 μ F 0603 X5R 25V 10%	
C602A, C602B, C702A, C702B	GRM21BR61C106K	CAP Ceramic 10 μ F 0805 X5R 16V 10%	
C704	GRM1885C1H3R9D	CAP Ceramic 3.9pF 0603 C0G 50V \pm 0.5pF	
Inductor			
L1	CDRH4D22/HP-2R2NC	Power Inductor 2.2 μ H 3.2A SMD	Sumida
L2SD	CDRH2D14-3R3NC	Power Inductor 3.3 μ H 1.2A SMD	
L3, L4	CDRH2D18/HPNP-2R2NC	Power Inductor 2.2 μ H 1.6A SMD	
L5, L6, L7	CDRH2D14 NP-4R7NC	Power Inductor 4.7 μ H 1.0A SMD	
Resistor			
R2D1, R2D2, R303 R403, R503, R504, R506, R604, R703	RC0603FR-070RL	RES 0 Ω 1/10W 1% 0603 SMD	Yageo
R101	RC0603FR-07432KL	RES 432K Ω 1/10W 1% 0603 SMD	
R102, R202, R302 R402, R502, R602, R702	RC0603FR-0759KL	RES 59K Ω 1/10W 1% 0603 SMD	
R201	RC0603FR-07267KL	RES 267K Ω 1/10W 1% 0603 SMD	
R301	RC0603FR-07187KL	RES 187K Ω 1/10W 1% 0603 SMD	
R401	RC0603FR-07118KL	RES 118K Ω 1/10W 1% 0603 SMD	
R501	RC0603FR-071M54L	RES 1.54M Ω 1/10W 1% 0603 SMD	
R601	RC0402FR-071M42L	RES 1.42M Ω 1/16W 1% 0402 SMD	
R701	RC0603FR-07732KL	RES 732K Ω 1/10W 1% 0603 SMD	
Other			
D501, D502, D503, D504	RS-0805	30mA White LED 0805	Realstar
D5, D6, D7	MBR0530	Diode Schottky 0.5A 30V SOD-123	International Rectifier

Table 6: AAT2610 Li-ion Application Demo Board Bill of Materials (BOM).

AAT2610**Seven-Channel PMU for Digital Still Cameras**

Designation	Part Number	Description	Manufacturer
IC Device			
U1	AAT2610IIC	Seven-Channel High Efficiency Power Management Unit	Skyworks
Capacitor			
C	T494B106M010AS	CAP TAN 10 μ F B 10V 20%	KEMET
C101	GRM21BR61C475K	CAP Ceramic 4.7 μ F 0805 X5R 16V 10%	Murata
C102, C703	GRM185R61A105K	CAP Ceramic 1 μ F 0603 X5R 10V 10%	
C103A, C201A, C201B, C302	GRM21BR60J226M	CAP Ceramic 22 μ F 0805 X5R 6.3V 20%	
C203	GRM1885C1H820J	CAP Ceramic 82pF 0603 C0G 50V 5%	
C204, C301, C401, C402, C501, C503, C601, C701	GRM188R60J475K	CAP Ceramic 4.7 μ F 0603 X5R 6.3V 10%	
C303	GRM1885C1H150J	CAP Ceramic 15pF 0603 C0G 50V 5%	
C403	GRM1885C1H5R6D	CAP Ceramic 5.6pF 0603 C0G 50V \pm 0.5pF	
C502	GRM21BR61E475KA	CAP Ceramic 4.7 μ F 0805 X5R 25V 10%	
C602A, C602B, C702A, C702B	GRM21BR61C106K	CAP Ceramic 10 μ F 0805 X5R 16V 10%	
C603	GRM1885C1H6R8D	CAP Ceramic 6.8pF 0603 C0G 50V \pm 0.5pF	
C704	GRM1885C1H1R5D	CAP Ceramic 1.5pF 0603 C0G 50V \pm 0.5pF	
Inductor			
L1	CDRH4D22/HP-2R2NC	Power Inductor 2.2 μ H 3.2A SMD	Sumida
L2SU, L3, L4	CDRH2D18/HPNP-2R2NC	Power Inductor 2.2 μ H 1.6A SMD	
L5,	CDRH2D14 NP-4R7NC	Power Inductor 4.7 μ H 1.0A SMD	
L6, L7	CDRH2D18/HP-100	Power Inductor 10 μ H 0.85A SMD	
Resistor			
R2U1, R2U2, R2U3 R303, R404, R503, R504, R506, R604, R704	RC0603FR-070RL	RES 0 Ω 1/10W 1% 0603 SMD	Yageo
R101	RC0603FR-07432KL	RES 432K Ω 1/10W 1% 0603 SMD	
R102, R202, R301, R302, R402, R502, R602	RC0603FR-0759KL	RES 59K Ω 1/10W 1% 0603 SMD	
R201	RC0603FR-07267KL	RES 267K Ω 1/10W 1% 0603 SMD	
R401	RC0603FR-07187KL	RES 187K Ω 1/10W 1% 0603 SMD	
R501	RC0603FR-071M54L	RES 1.54M Ω 1/10W 1% 0603 SMD	
R601	RC0603FR-071M2L	RES 1.2M Ω 1/10W 1% 0603 SMD	
R701	RC0603FR-07732KL	RES 732K Ω 1/10W 1% 0603 SMD	
R702	RC0603FR-0751KL	RES 51K Ω 1/10W 1% 0603 SMD	
Other			
D501, D502, D503, D504	RS-0805	30mA White LED 0805	Realstar
D5, D6, D7	MBR0530	Diode Schottky 0.5A 30V SOD-123	International Rectifier

Table 7: AAT2610 2AA Application Demo Board Bill of Material (BOM).

Seven-Channel PMU for Digital Still Cameras**Ordering Information**

Output Voltage	Package	Marking ¹	Part Number(Tape & Reel) ²
Adj. 0.6V	TQFN55-40L	3GXYY	AAT2610IIC-T1



Skyworks Green™ products are compliant with all applicable legislation and are halogen-free.

For additional information, refer to *Skyworks Definition of Green™*, document number SQ04-0074.

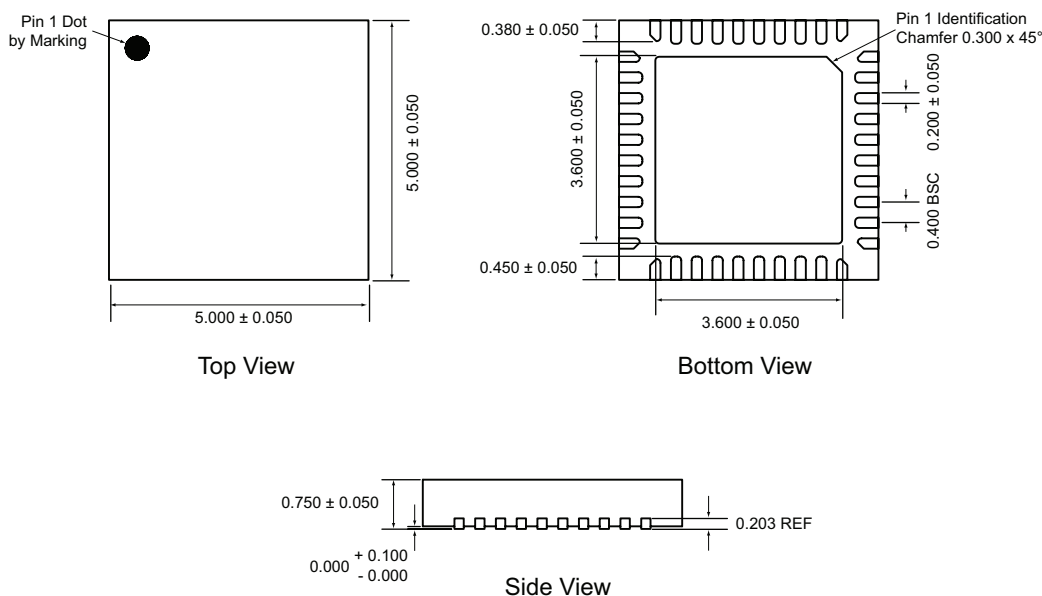
Package Information**TQFN55-40L³**

All dimensions in millimeters.

1. XYY = assembly and date code.
2. Sample stock is generally held on part numbers listed in **BOLD**.
3. The leadless package family, which includes QFN, TQFN, DFN, TDFN and STDFN, has exposed copper (unplated) at the end of the lead terminals due to the manufacturing process. A solder fillet at the exposed copper edge cannot be guaranteed and is not required to ensure a proper bottom solder connection.

Copyright © 2012 Skyworks Solutions, Inc. All Rights Reserved.

Information in this document is provided in connection with Skyworks Solutions, Inc. ("Skyworks") products or services. These materials, including the information contained herein, are provided by Skyworks as a service to its customers and may be used for informational purposes only by the customer. Skyworks assumes no responsibility for errors or omissions in these materials or the information contained herein. Skyworks may change its documentation, products, services, specifications or product descriptions at any time, without notice. Skyworks makes no commitment to update the materials or information and shall have no responsibility whatsoever for conflicts, incompatibilities, or other difficulties arising from any future changes.

No license, whether express, implied, by estoppel or otherwise, is granted to any intellectual property rights by this document. Skyworks assumes no liability for any materials, products or information provided hereunder, including the sale, distribution, reproduction or use of Skyworks products, information or materials, except as may be provided in Skyworks Terms and Conditions of Sale.

THE MATERIALS, PRODUCTS AND INFORMATION ARE PROVIDED "AS IS" WITHOUT WARRANTY OF ANY KIND, WHETHER EXPRESS, IMPLIED, STATUTORY, OR OTHERWISE, INCLUDING FITNESS FOR A PARTICULAR PURPOSE OR USE, MERCHANTABILITY, PERFORMANCE, QUALITY OR NON-INFRINGEMENT OF ANY INTELLECTUAL PROPERTY RIGHT; ALL SUCH WARRANTIES ARE HEREBY EXPRESSLY DISCLAIMED. SKYWORKS DOES NOT WARRANT THE ACCURACY OR COMPLETENESS OF THE INFORMATION, TEXT, GRAPHICS OR OTHER ITEMS CONTAINED WITHIN THESE MATERIALS. SKYWORKS SHALL NOT BE LIABLE FOR ANY DAMAGES, INCLUDING BUT NOT LIMITED TO ANY SPECIAL, INDIRECT, INCIDENTAL, STATUTORY, OR CONSEQUENTIAL DAMAGES, INCLUDING WITHOUT LIMITATION, LOST REVENUES OR LOST PROFITS THAT MAY RESULT FROM THE USE OF THE MATERIALS OR INFORMATION, WHETHER OR NOT THE RECIPIENT OF MATERIALS HAS BEEN ADVISED OF THE POSSIBILITY OF SUCH DAMAGE.

Skyworks products are not intended for use in medical, lifesaving or life-sustaining applications, or other equipment in which the failure of the Skyworks products could lead to personal injury, death, physical or environmental damage. Skyworks customers using or selling Skyworks products for use in such applications do so at their own risk and agree to fully indemnify Skyworks for any damages resulting from such improper use or sale.

Customers are responsible for their products and applications using Skyworks products, which may deviate from published specifications as a result of design defects, errors, or operation of products outside of published parameters or design specifications. Customers should include design and operating safeguards to minimize these and other risks. Skyworks assumes no liability for applications assistance, customer product design, or damage to any equipment resulting from the use of Skyworks products outside of stated published specifications or parameters.

Skyworks, the Skyworks symbol, and "Breakthrough Simplicity" are trademarks or registered trademarks of Skyworks Solutions, Inc., in the United States and other countries. Third-party brands and names are for identification purposes only, and are the property of their respective owners. Additional information, including relevant terms and conditions, posted at www.skyworksinc.com, are incorporated by reference.