



# SAW Components

## SAW Duplexer

Automotive telematics

<b>Series/type:</b>	<b>B4406</b>
<b>Ordering code:</b>	<b>B39182B4406P810</b>
<b>Date:</b>	<b>June 13, 2014</b>
<b>Version:</b>	<b>2.3</b>

© EPCOS AG 2015. Reproduction, publication and dissemination of this publication, enclosures hereto and the information contained therein without EPCOS' prior express consent is prohibited.

EPCOS AG is a TDK Group Company.

Data sheet

**Application**

- Low-loss SAW duplexer for Band III systems
- Low insertion attenuation
- Low amplitude ripple
- Usable passband 75 MHz
- Single ended to balanced transformation in Antenna - Rx path
- Impedance transformation 50Ω to 100Ω in Antenna - Rx path
- high Tx - Rx isolation

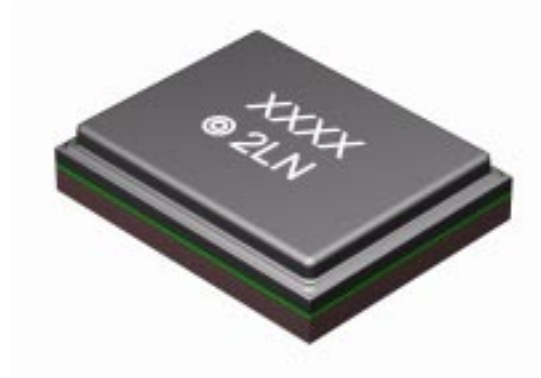
**Features**

- Package size 2.0 \* 1.6 mm<sup>2</sup>
- Package height max. 0.45 mm
- RoHS compatible
- Approx. weight 0.005 g
- Package for **Surface Mount Technology (SMT)**
- Ni terminals, Au-plated
- **Electrostatic Sensitive Device (ESD)**
- AEC-Q200 qualified component family (operable temperature range -40°C to +85°C)

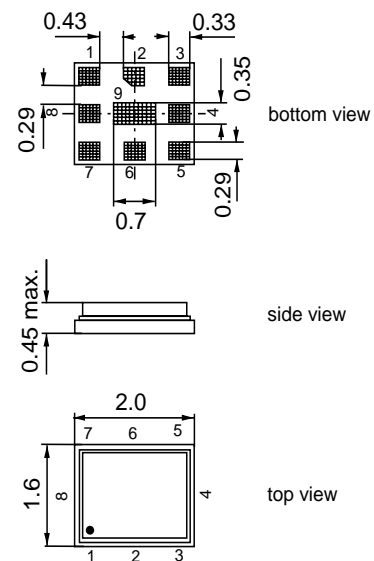
**Pin configuration**

- 3 Tx input
- 1, 8 Rx output (balanced)
- 6 Antenna
- 2, 4, 5, 7, 9 To be grounded

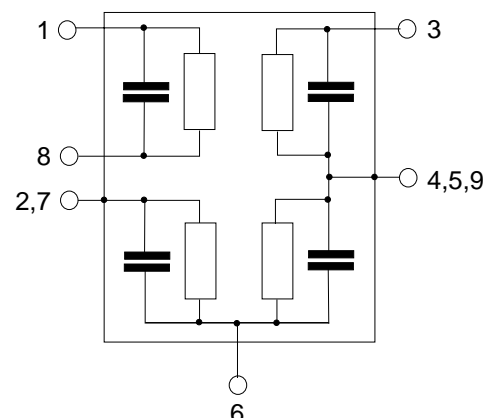

Data sheet

**Characteristics**

Temperature range for specification:	T = -30 °C to +85 °C
ANT terminating impedance:	Z <sub>ANT</sub> = 50 Ω    3.9nH
Rx terminating impedance:	Z <sub>RX</sub> = 100 Ω (balanced)   12nH
Tx terminating impedance:	Z <sub>TX</sub> = 50 Ω

Characteristics Tx-ANT		min.	typ. @ 25°C	max.	
<b>Center frequency</b>	f <sub>C</sub>	–	1747.5	–	MHz
<b>Maximum insertion attenuation</b>	α <sub>max</sub>				
1714.00 ... 1781.00 MHz		–	2.0	3.1	dB
1710.00 ... 1785.00 MHz		–	2.5	4.1	dB
<b>Amplitude ripple per 5MHz channel</b>	Δα				
1710.00 ... 1785.00 MHz		–	0.6	1.4	dB
<b>VSWR</b>					
Tx port 1710.00 ... 1785.00 MHz		–	1.5	2.0	
ANT port 1710.00 ... 1785.00 MHz		–	1.5	2.0	
<b>Attenuation</b>	α				
100.00 ... 1565.42 MHz		30	33	–	dB
1565.42 ... 1573.38 MHz		40	46	–	dB
1573.38 ... 1577.46 MHz		42	47	–	dB
1577.46 ... 1585.42 MHz		40	44	–	dB
1597.55 ... 1605.88 MHz		35	39	–	dB
1605.88 ... 1680.00 MHz		20	30	–	dB
1805.00 ... 1880.00 MHz		43	46	–	dB
1920.00 ... 1980.00 MHz		20	30	–	dB
2110.00 ... 2170.00 MHz		27	40	–	dB
2400.00 ... 2500.00 MHz		30	34	–	dB
2620.00 ... 2690.00 MHz		27	31	–	dB

Data sheet

**Characteristics**

Temperature range for specification:	$T = -30\text{ °C to }+85\text{ °C}$
ANT terminating impedance:	$Z_{ANT} = 50\ \Omega \parallel 3.9\text{nH}$
Rx terminating impedance:	$Z_{RX} = 100\ \Omega \text{ (balanced)} \parallel 12\text{nH}$
Tx terminating impedance:	$Z_{TX} = 50\ \Omega$

Characteristics ANT-Rx		min.	typ. @ 25°C	max.	
<b>Center frequency</b>	$f_C$	–	1842.5	–	MHz
<b>Maximum insertion attenuation</b> 1805.00 ... 1880.00 MHz	$\alpha_{max}$	–	3.2	4.4	dB
<b>Amplitude ripple</b> per 5MHz channel 1805.00 ... 1880.00 MHz	$\Delta\alpha$	–	0.7	1.8	dB
<b>Common mode rejection ratio</b> 1805.00 ... 1880.00 MHz		20 <sup>1)</sup>	25	–	dB
<b>VSWR</b>					
Rx port 1805.00 ... 1880.00 MHz		–	1.6	2.0	
ANT port 1805.00 ... 1880.00 MHz		–	1.6	2.0	
<b>Attenuation</b>	$\alpha$				
100.00 ... 1710.00 MHz		35	55	–	dB
1710.00 ... 1785.00 MHz		43	50	–	dB
1965.00 ... 2690.00 MHz		30	52	–	dB

1) A combination of 10° phase balance and 1 dB amplitude balance corresponds to 19.6 dB CMRR

**SAW Components**
**B4406**
**SAW Duplexer**
**1747.5 / 1842.5 MHz**

Data sheet

**Characteristics**

Temperature range for specification:	$T = -30\text{ °C to }+85\text{ °C}$
ANT terminating impedance:	$Z_{ANT} = 50\ \Omega \parallel 3.9\text{nH}$
Rx terminating impedance:	$Z_{RX} = 100\ \Omega \text{ (balanced)} \parallel 12\text{nH}$
Tx terminating impedance:	$Z_{TX} = 50\ \Omega$

Characteristics Tx-Rx		min.	typ. @ 25°C	max.	
<b>Differential Mode Isolation</b>	$\alpha$				
	1710.00 ... 1785.00 MHz	50	55	–	dB
	1805.00 ... 1880.00 MHz	50	53	–	dB
<b>Common Mode Isolation</b>					
	1710.00 ... 1785.00 MHz	50	55	–	dB

**Maximum ratings**

Operable temperature range	$T$	–40/+85	°C	
Storage temperature range	$T_{stg}$	–40/+85	°C	
DC voltage	$V_{DC}$	0	V	
Input Power at 1710.0 ... 1785.0 MHz	$P_{IN}$	29	dBm	} continuous wave $T = 55\text{ °C}, 5000\text{ h}$
elsewhere		10	dBm	

Data sheet



**Frequency Response Tx-ANT**

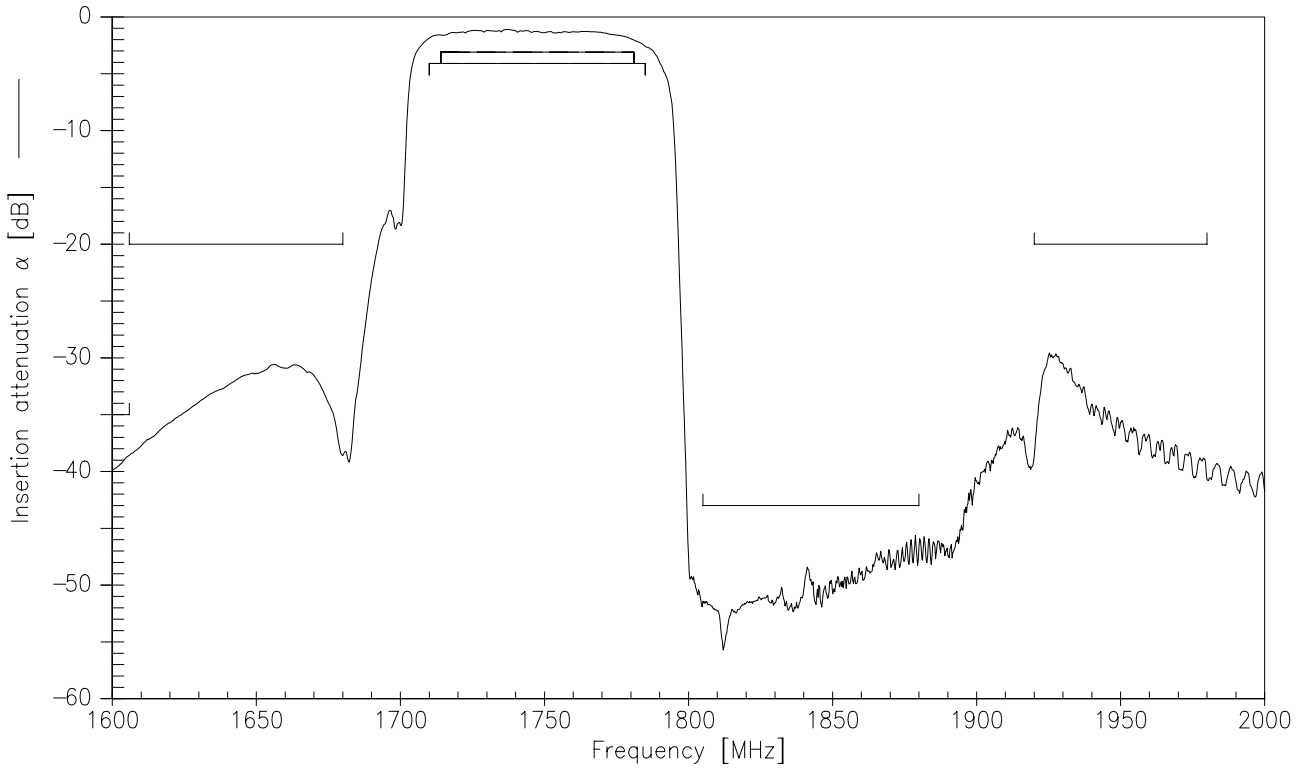

**Frequency Response Tx-ANT (wideband)**

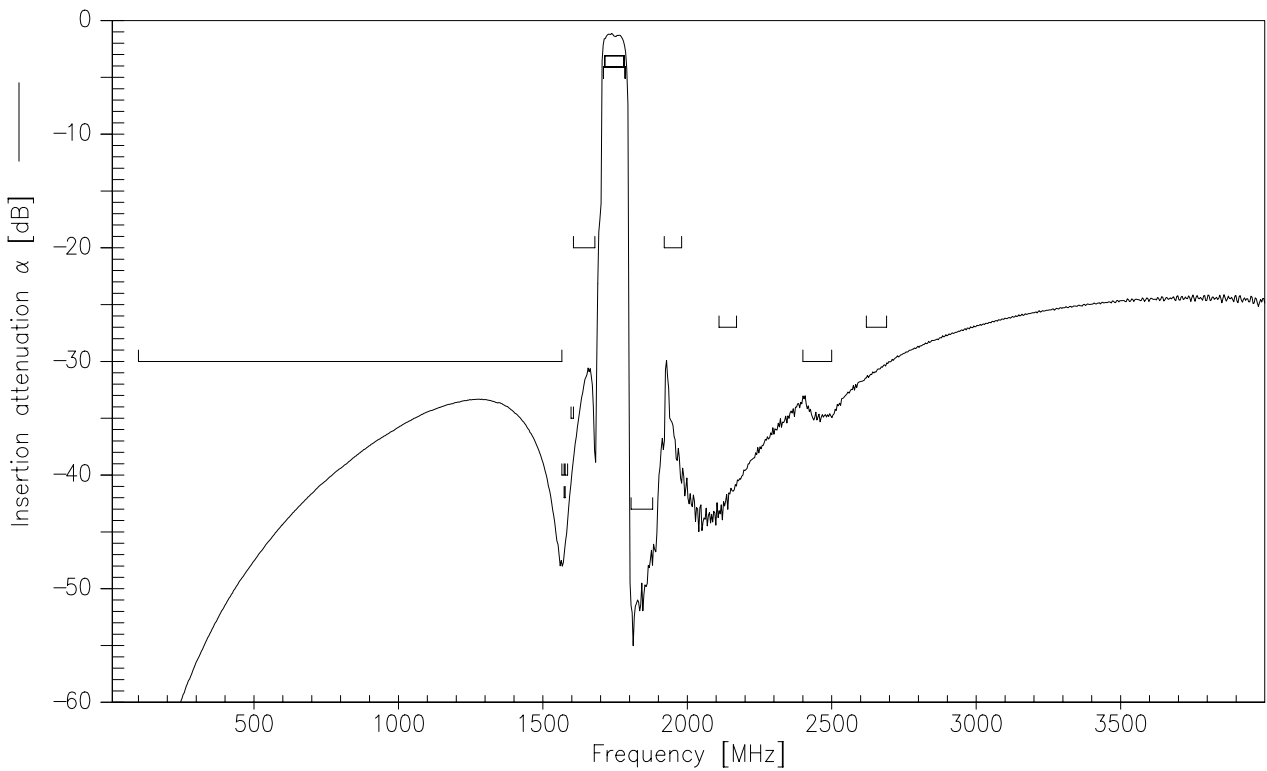

Data sheet



**Frequency Response Rx-ANT**

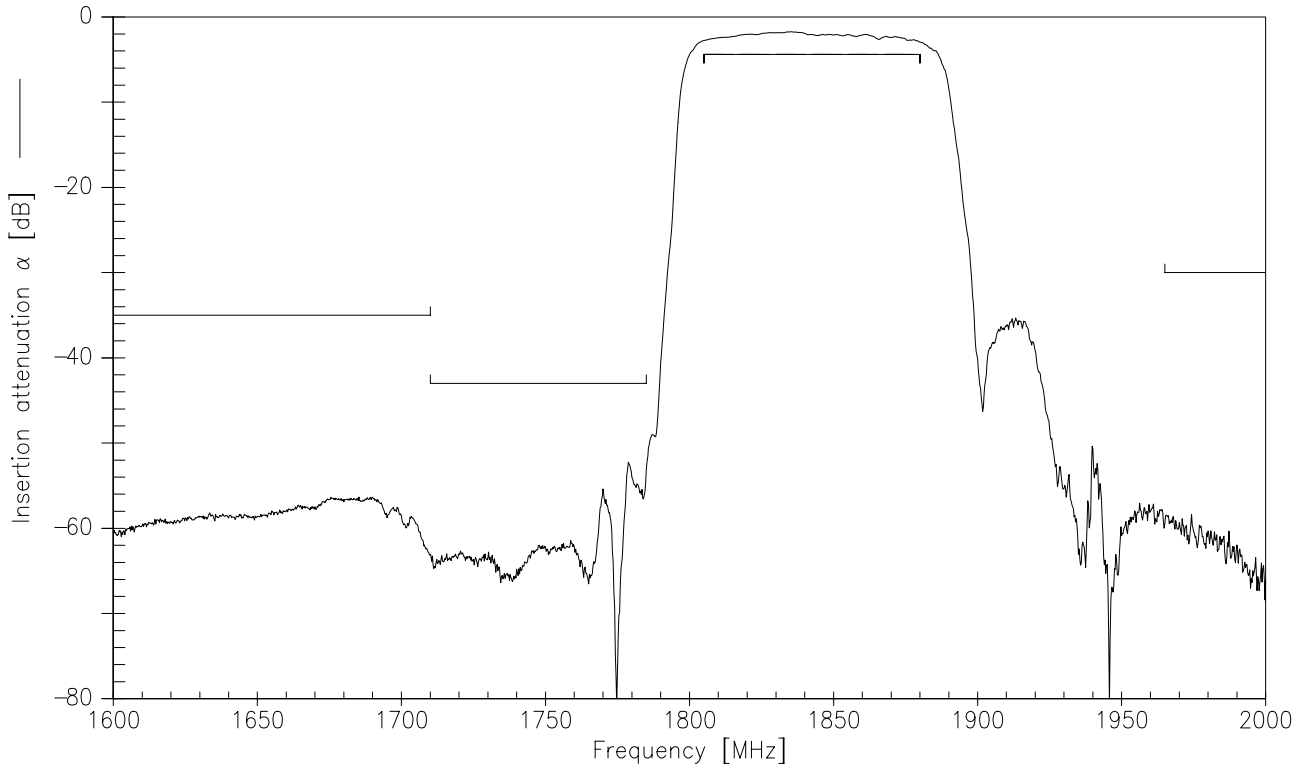

**Frequency Response Rx-ANT (wideband)**

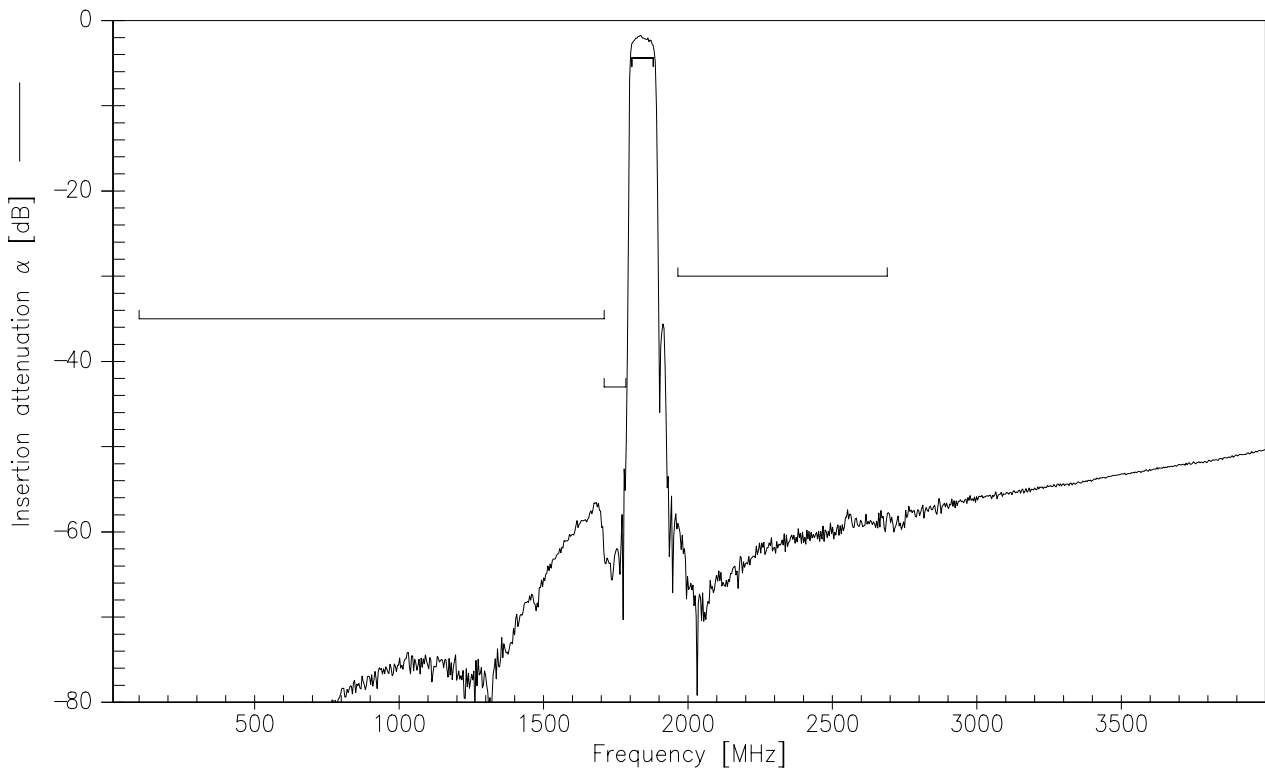

Data sheet



**Frequency Response Tx-Rx (differential mode)**

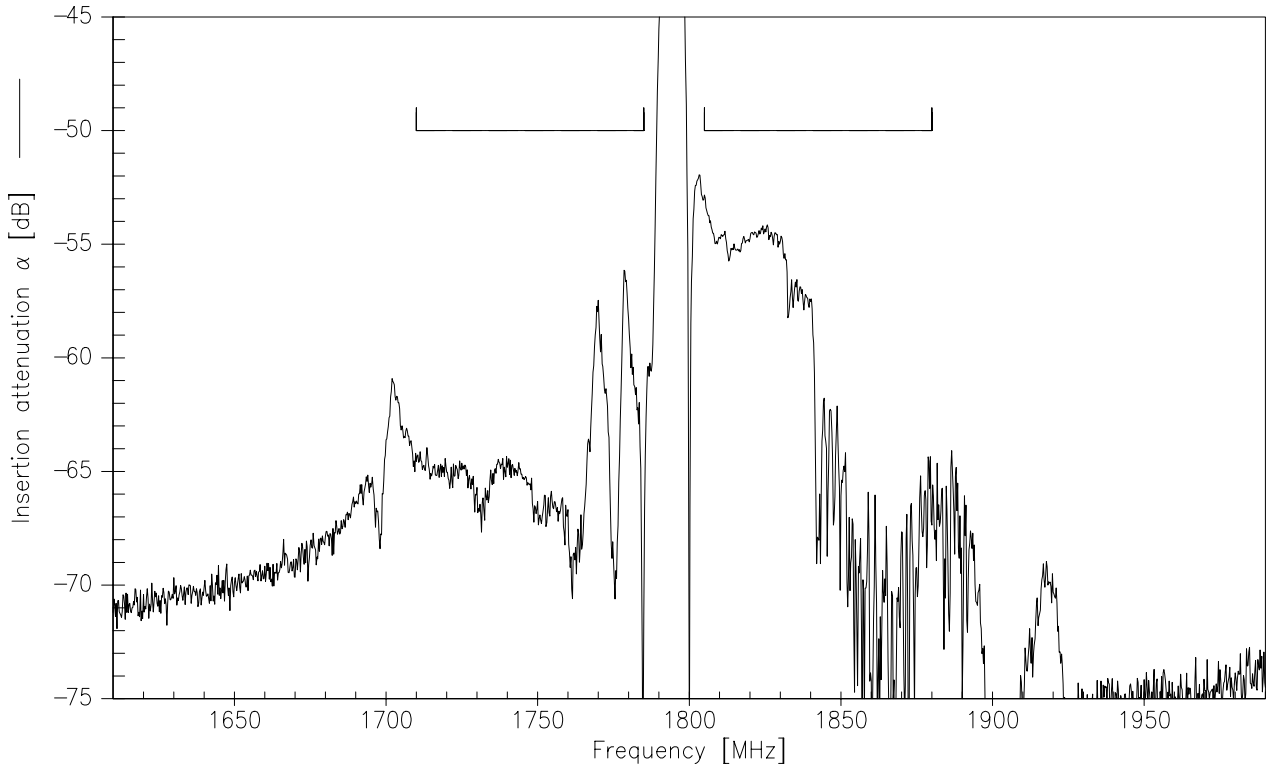

**Frequency Response Tx-Rx (differential mode, wideband)**

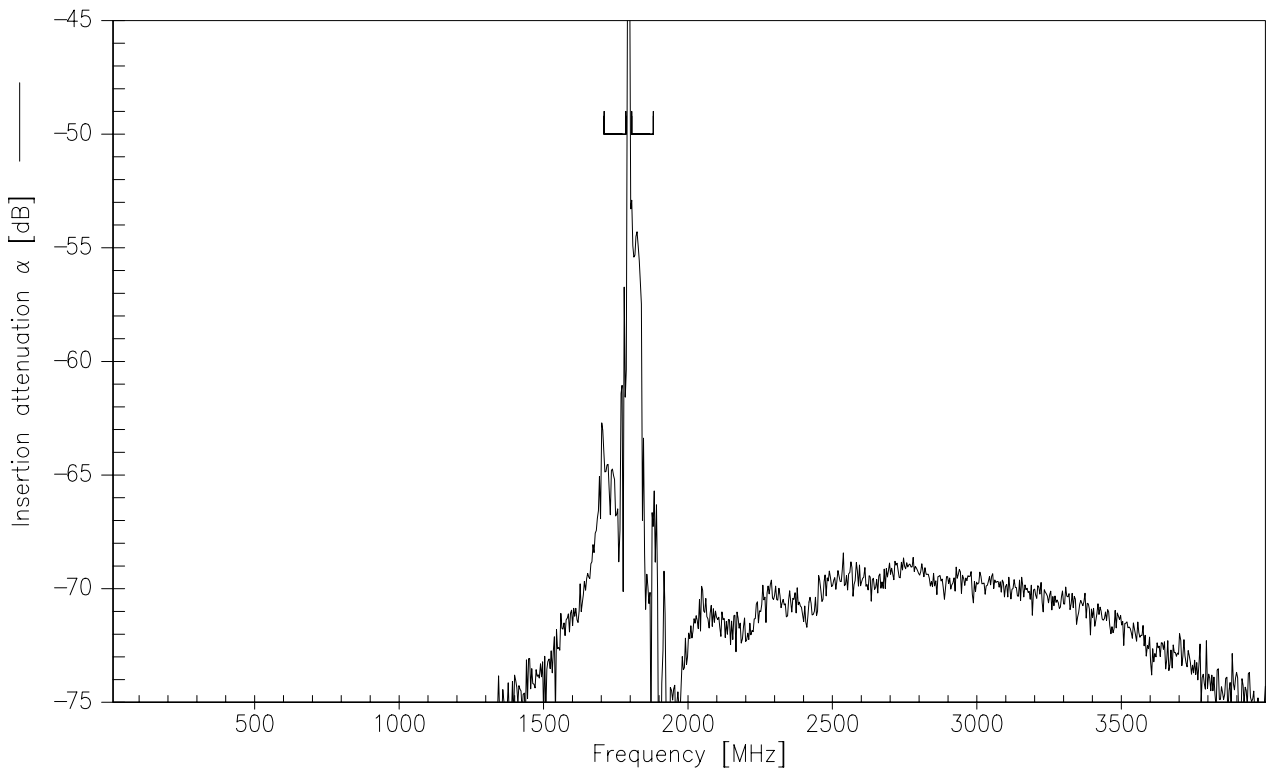



Data sheet



**Frequency Response Tx-Rx (common mode)**

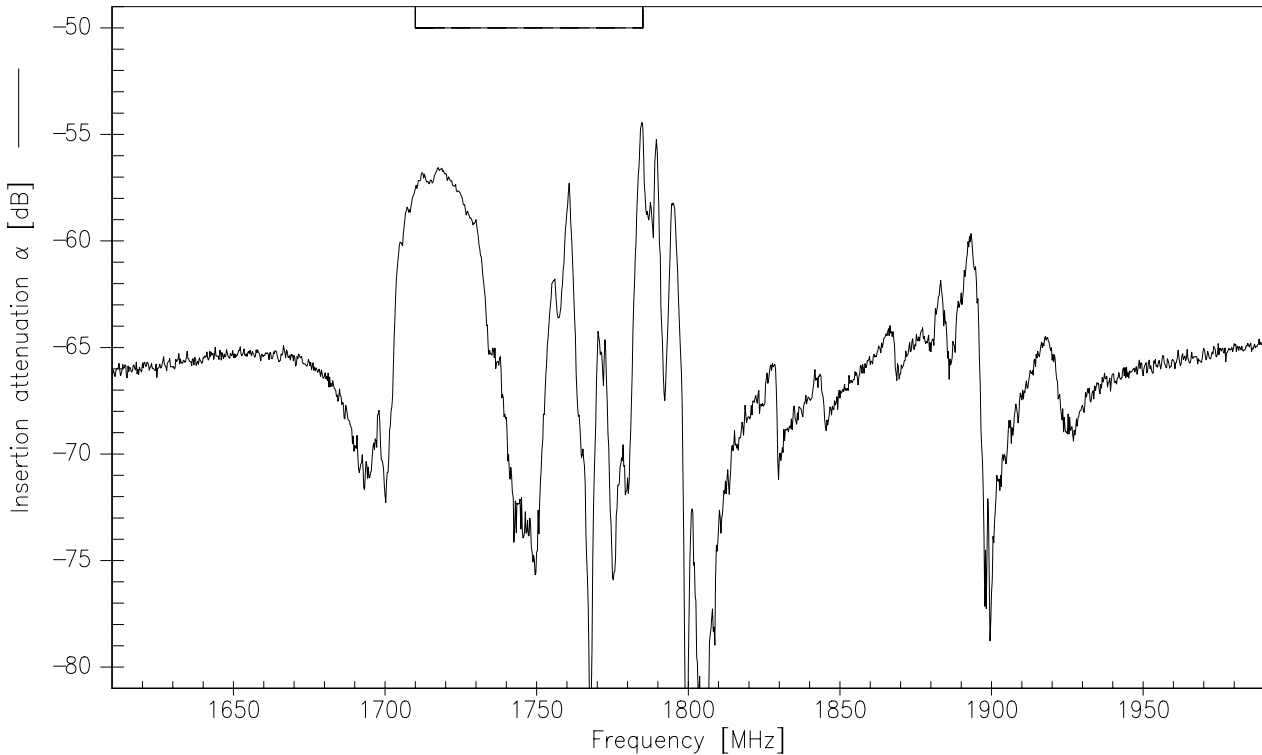

**Frequency Response Common Mode Rejection Ratio**

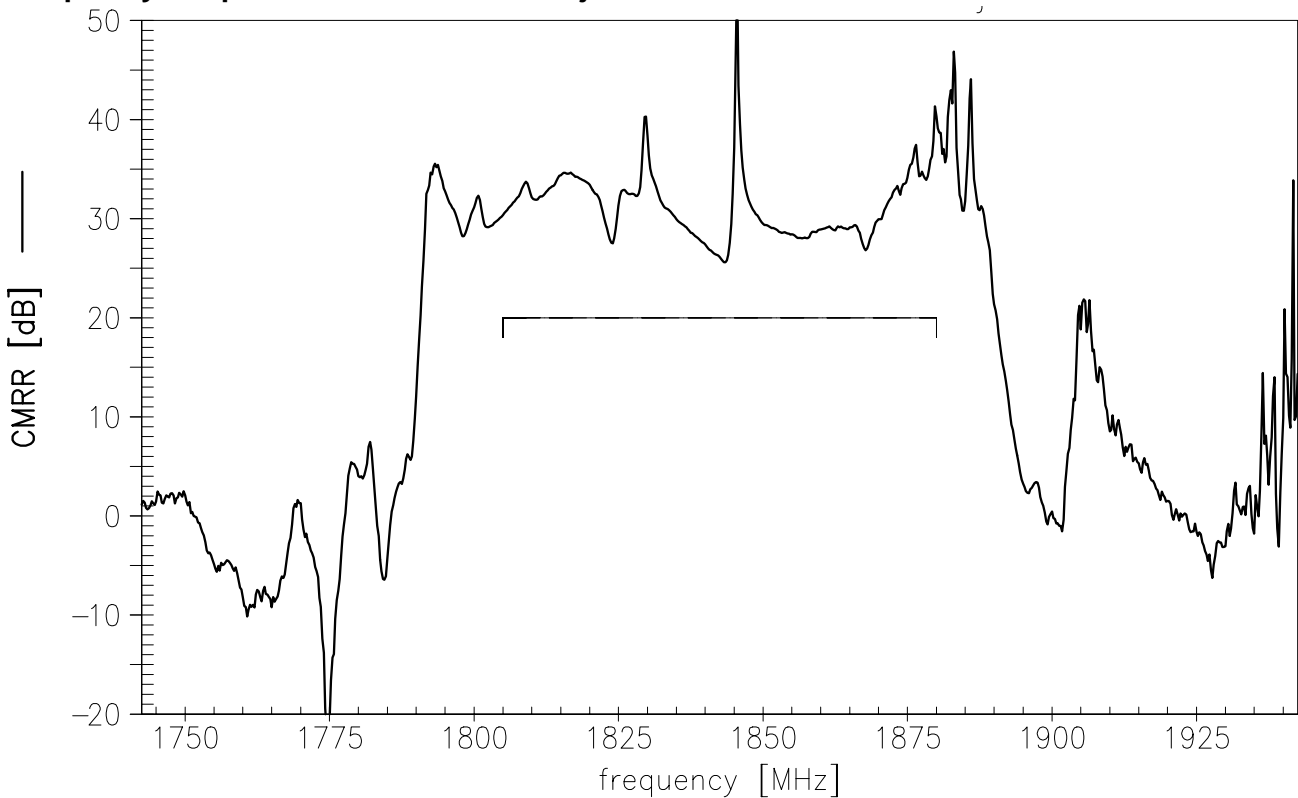

Data sheet



VSWR at Tx-, Rx- and Antenna

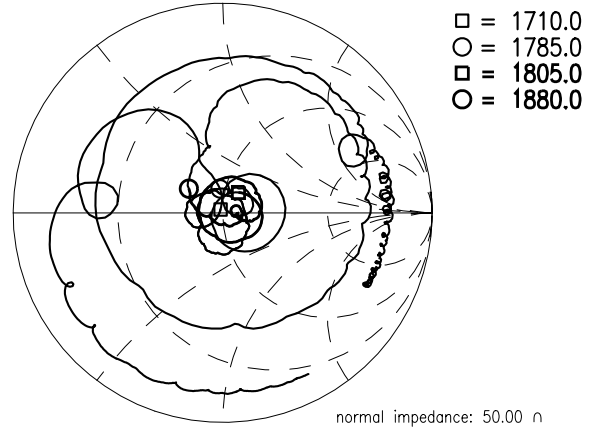
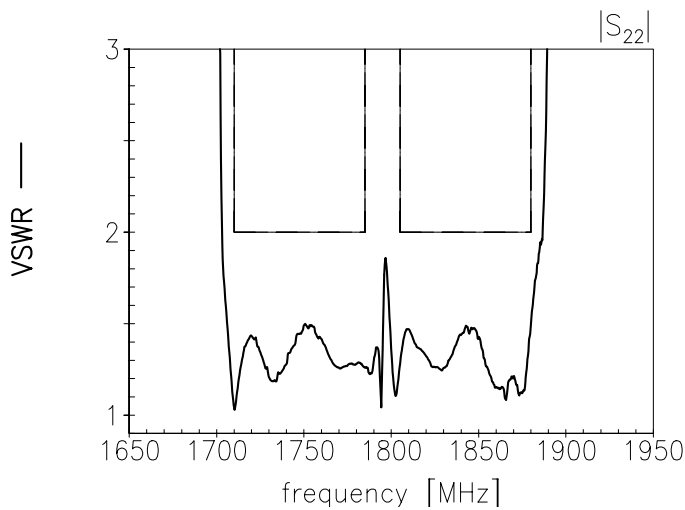
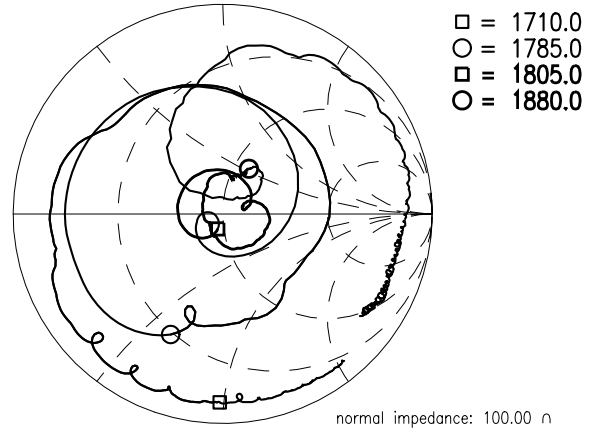
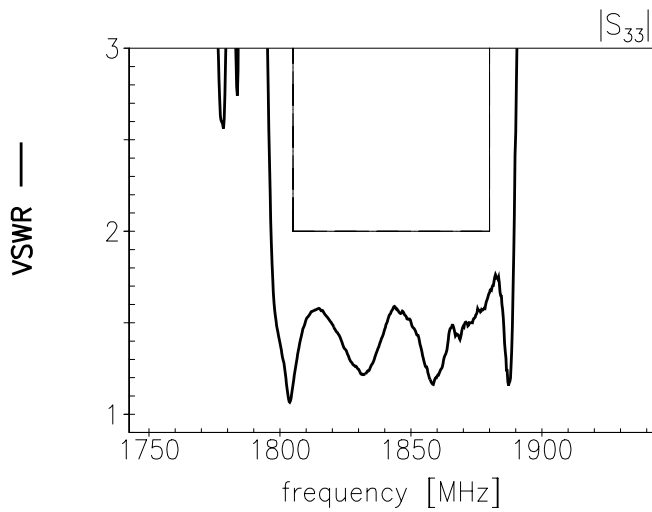
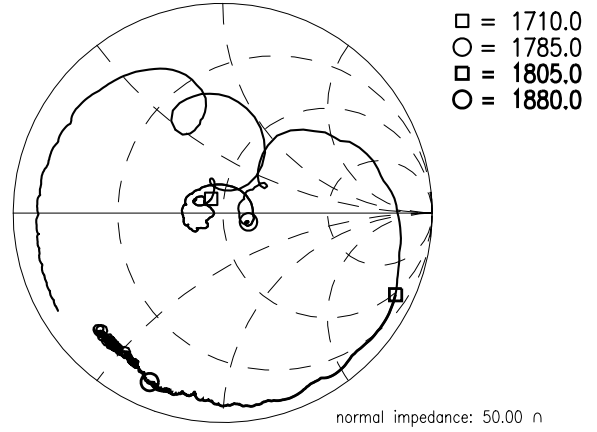
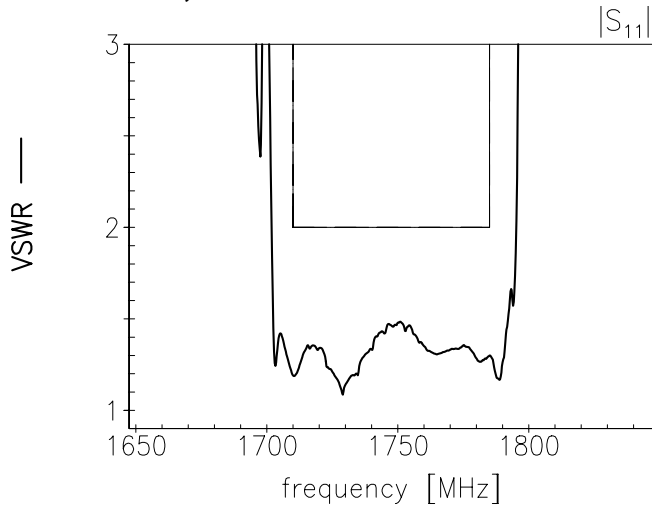

**SAW Components**
**B4406**
**SAW Duplexer**
**1747.5 / 1842.5 MHz**

Data sheet



References

<b>Type</b>	B4406
<b>Ordering code</b>	B39182B4406P810
<b>Marking and Package</b>	C61157-A8-A64
<b>Packaging</b>	F61074-V8247-Z000
<b>Date Codes</b>	L_1126
<b>S-Parameters</b>	B4406_NB_UN.s4p, B4406_WB_UN.s4p See file header for pin/port assignment table.
<b>Soldering profile</b>	S_6001
<b>RoHS compatible</b>	RoHS-compatible means that products are compatible with the requirements according to Art. 4 (substance restrictions) of Directive 2011/65/EU of the European Parliament and of the Council of June 8 <sup>th</sup> , 2011, on the restriction of the use of certain hazardous substances in electrical and electronic equipment ("Directive") with due regard to the application of exemptions as per Annex III of the Directive in certain cases.
<b>Moldability</b>	Before using in overmolding environment, please contact your EPCOS sales office.
<b>Matching coils</b>	See Inductor pdf-catalog <a href="http://www.tdk.co.jp/tefe02/coil.htm#aname1">http://www.tdk.co.jp/tefe02/coil.htm#aname1</a> and Data Library for circuit simulation <a href="http://www.tdk.co.jp/etvcl/index.htm">http://www.tdk.co.jp/etvcl/index.htm</a>

For further information please contact your local EPCOS sales office or visit our webpage at [www.epcos.com](http://www.epcos.com).

**Published by EPCOS AG**  
**Systems, Acoustics, Waves Business Group**  
**P.O. Box 80 17 09, 81617 Munich, GERMANY**

© EPCOS AG 2014. This brochure replaces the previous edition.

For questions on technology, prices and delivery please contact the Sales Offices of EPCOS AG or the international Representatives.

Due to technical requirements components may contain dangerous substances. For information on the type in question please also contact one of our Sales Offices.

## Important notes

The following applies to all products named in this publication:

1. Some parts of this publication contain **statements about the suitability of our products for certain areas of application**. These statements are based on our knowledge of typical requirements that are often placed on our products in the areas of application concerned. We nevertheless expressly point out **that such statements cannot be regarded as binding statements about the suitability of our products for a particular customer application**. As a rule, EPCOS is either unfamiliar with individual customer applications or less familiar with them than the customers themselves. For these reasons, it is always ultimately incumbent on the customer to check and decide whether an EPCOS product with the properties described in the product specification is suitable for use in a particular customer application.
2. We also point out that **in individual cases, a malfunction of electronic components or failure before the end of their usual service life cannot be completely ruled out in the current state of the art, even if they are operated as specified**. In customer applications requiring a very high level of operational safety and especially in customer applications in which the malfunction or failure of an electronic component could endanger human life or health (e.g. in accident prevention or life-saving systems), it must therefore be ensured by means of suitable design of the customer application or other action taken by the customer (e.g. installation of protective circuitry or redundancy) that no injury or damage is sustained by third parties in the event of malfunction or failure of an electronic component.
3. **The warnings, cautions and product-specific notes must be observed.**
4. In order to satisfy certain technical requirements, **some of the products described in this publication may contain substances subject to restrictions in certain jurisdictions (e.g. because they are classed as hazardous)**. Useful information on this will be found in our Material Data Sheets on the Internet ([www.epcos.com/material](http://www.epcos.com/material)). Should you have any more detailed questions, please contact our sales offices.
5. We constantly strive to improve our products. Consequently, **the products described in this publication may change from time to time**. The same is true of the corresponding product specifications. Please check therefore to what extent product descriptions and specifications contained in this publication are still applicable before or when you place an order. We also **reserve the right to discontinue production and delivery of products**. Consequently, we cannot guarantee that all products named in this publication will always be available. The aforementioned does not apply in the case of individual agreements deviating from the foregoing for customer-specific products.
6. Unless otherwise agreed in individual contracts, **all orders are subject to the current version of the “General Terms of Delivery for Products and Services in the Electrical Industry” published by the German Electrical and Electronics Industry Association (ZVEI)**.
7. The trade names EPCOS, BAOKE, Alu-X, CeraDiode, CeraLink, CeraPlas, CSMP, CSSP, CTVS, DeltaCap, DigiSiMic, DSSP, FilterCap, FormFit, MiniBlue, MiniCell, MKD, MKK, MLSC, MotorCap, PCC, PhaseCap, PhaseCube, PhaseMod, PhiCap, SIFERRIT, SIFI, SIKOREL, SilverCap, SIMDAD, SiMic, SIMID, SineFormer, SIOV, SIP5D, SIP5K, TFAP, ThermoFuse, WindCap are **trademarks registered or pending** in Europe and in other countries. Further information will be found on the Internet at [www.epcos.com/trademarks](http://www.epcos.com/trademarks).