

Description

Fast Delivery Time

PXXX0S1ALRP Series are micro capacitance SIDACtor Protection Thyristor designed to protect telecommunications equipment such as ADSL Modems,Router, , Telephone, CCTV Camera,Digital Video Record,Video Capture Card,Twisted-pair video transmitter,CATV Splitter.....Etc.

PXXX0S1ALRP Series SIDACtor Protection Thyristor are used to enable equipment to meet various regulatory requirements including GR 1089, ITU K.20/21,IEC 61000-4-5, YD/T 1082,YD/T 993,YD/T 950,TIA-968-A ,TIA-968-B



Features

Compared to surge suppression using other technologies, PXXX0S1ALRP Series devices offer absolute surge protection regardless of the surge current available and the rate of applied voltage (dv/dt). PXXX0S1ALRP Series devices:

- 100% Lead-Free(RoHs Compliant)
- Cannot be damaged by voltage
- Eliminate hysteresis and heat dissipation typically found with clamping devices
- Eliminate voltage overshoot caused by fast-rising transients
- Are non-degenerative
- Have low capacitance, making them ideal for high-speed transmission equipment

Electrical Characteristics

Parameter	Definition
V_{DRM}	Peak Off-state Voltage — maximum voltage that can be applied while maintaining off state
V_S	Switching Voltage — maximum voltage prior to switching to on state
I_H	Holding Current — minimum current required to maintain on state
I_S	Switching Current — maximum current required to switch to on state
I_T	On-state Current — maximum rated continuous on-state current
V_T	On-state Voltage — maximum voltage measured at rated on-state current
Capacitance	Off-state Capacitance — typical capacitance measured in off state
I_{DRM}	Leakage Current — maximum peak off-state current measured at V_{DRM}
I_{PP}	Peak Pulse Current — maximum rated peak impulse current
I_{TSM}	Peak One-cycle Surge Current — maximum rated one-cycle AC current
di/dt	Rate of Rise of Current — maximum rated value of the acceptable rate of rise in current over time

Electrical Characteristics



Part Number	Marking	V_{DRM}	V_s	I_H	I_s	I_T	V_T	Capacitance
		@ $I_{DRM}=5 \mu A$	@ $100V/\mu s$	mA_{min}	mA_{max}	A_{max}	@ $I_T=2.2Amps$	@ $1MHz, 2V$ bias
		V_{min}	V_{max}	mA_{min}	mA_{max}	A_{max}	V_{max}	pF
P0080S1ALRP	P008A	6	25	50	800	2.2	4	30
P1500S1ALRP	P15A	140	180	150	800	2.2	4	40
P1800S1ALRP	P18A	170	220	150	800	2.2	4	40
P2300S1ALRP	P23A	190	260	150	800	2.2	4	35
P2600S1ALRP	P26A	220	300	150	800	2.2	4	35
P3100S1ALRP	P31A	275	350	150	800	2.2	4	30
P3500S1ALRP	P35A	320	400	150	800	2.2	4	30

Notes:

-All measurements are made at an ambient temperature of 25°C .Ipp applies to -40°C through +85°C temperature range .

-Off-state capacitance(Co) is typical value.

*For surge ratings,see next page.

Surge Ratings



Series	I _{pp} 2x10μs Amps	I _{pp} 8x20μs Amps	I _{pp} 10x160μs Amps	I _{pp} 10x560μs Amps	I _{pp} 10x1000μs Amps	I _{pp} 5x320μs Amps	I _{pp} 5x310μs Amps	I _{pp} 10x360μs Amps	I _{TSM} 50/60Hz Amps	di/dt Amps/μs
A	150	150	90	50	45	75	75	75	20	500

Thermal Considerations

Package	DO-214AC/SMA	Symbol	Parameter	Value	Unit
		T _J	Operating Junction Temperature Range	-40 to +150	°C
		T _S	Storage Temperature Range	-65 to +150	°C
		R _{θJA}	Junction to Ambient on prited circuit	90	°C /W

Description of Part Number

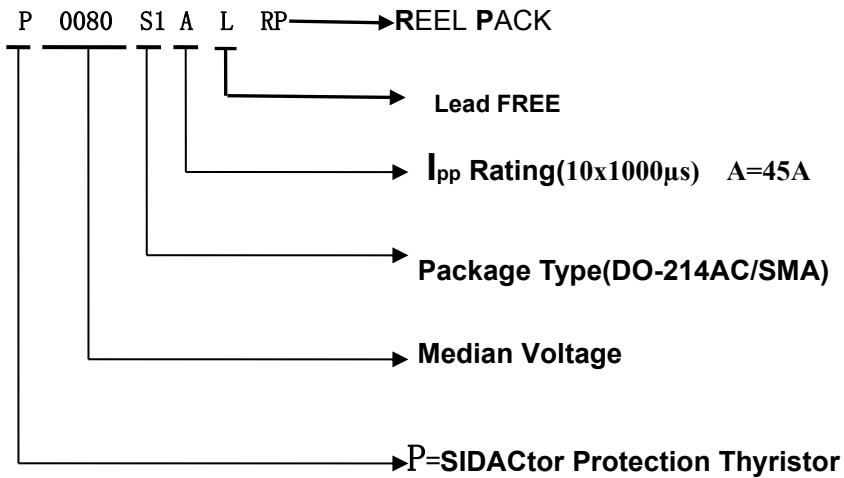

Dimensions - DO-214AC

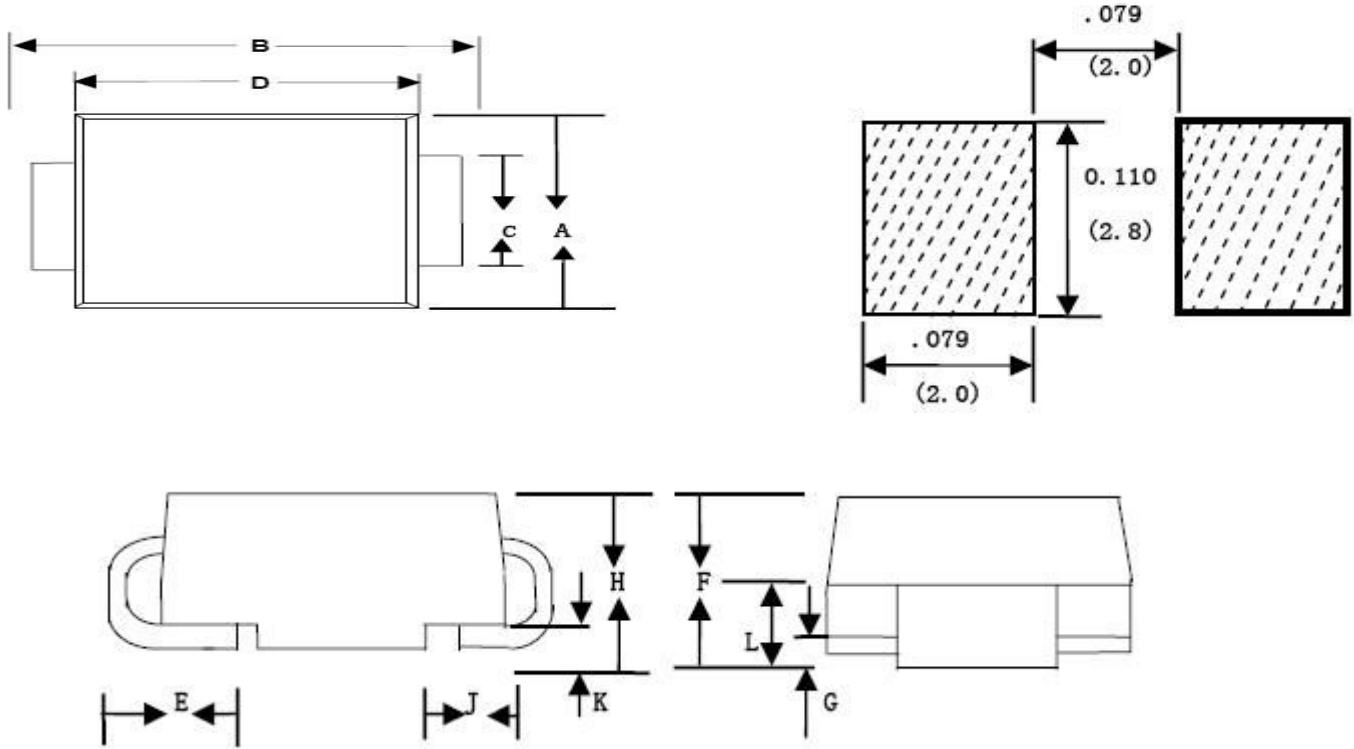

Dimension	Inches		Millimeters	
	Min	Max	Min	Max
A	0.098	0.114	2.50	2.90
B	0.188	0.208	4.80	5.28
C	0.055	0.062	1.40	1.60
D	0.157	0.181	4.00	4.60
E	0.030	0.060	0.76	1.52
F	0.078	0.096	2.00	2.44
H	0.080	0.104	2.05	2.64

Packing Options



Package Type	Description	Packing Quantity	Industry Standard
S1	DO-214AC Reel Pack	5000 PCS	EIA-481-D

Characteristics Curve

V-I Characteristics

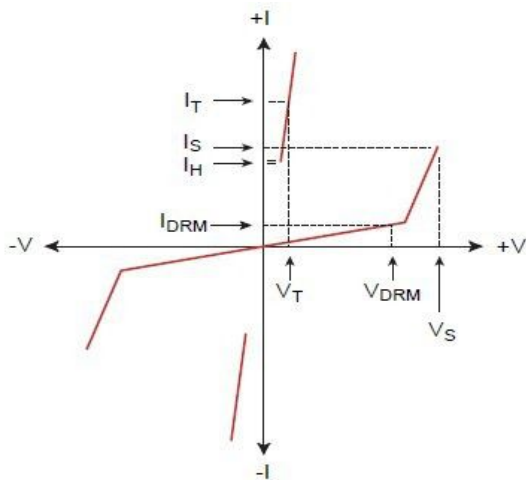

Tr x Td Pulse Waveform

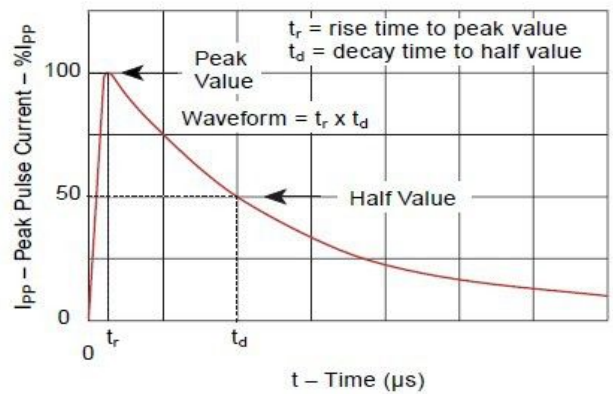

Normalized V_S Change Versus Junction Temperature

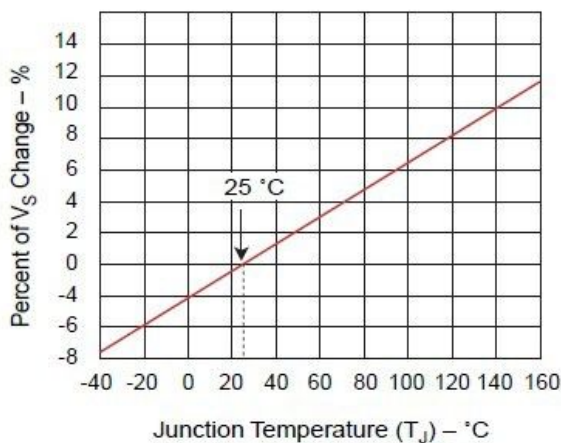

Normalized DC Holding Current Versus Case Temperature

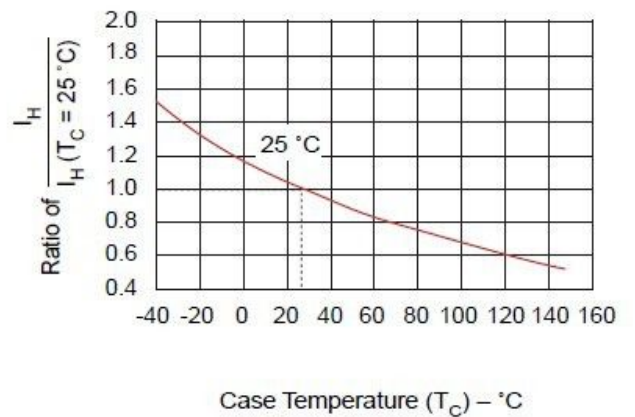

Sample pictures

P0080S1ALRP(Marking: P008A)

Fast Delivery Time



P2300S1ALRP(Marking: P23A)

Fast Delivery Time



P3100S1ALRP (Marking: P31A)

Fast Delivery Time

