

## Product Summary

$V_{(BR)DSS}$	$R_{DS(ON) \max}$	$I_D \max$ $T_A = +25^\circ\text{C}$
60V	$3\Omega @ V_{GS} = 10V$	300mA

## Description

This MOSFET has been designed to minimize the on-state resistance ( $R_{DS(ON)}$ ) and yet maintain superior switching performance, making it ideal for high efficiency power management applications.

## Applications

- Motor Control
- Power Management Functions

## Features and Benefits

- Low On-Resistance
- Low Gate Threshold Voltage
- Low Input Capacitance
- Fast Switching Speed
- Small Surface Mount Package
- **Totally Lead-Free & Fully RoHS Compliant (Notes 1 & 2)**
- **Halogen and Antimony Free. "Green" Device (Note 3)**
- **Qualified to AEC-Q101 Standards for High Reliability**

## Mechanical Data

- Case: SOT23
- Case Material: Molded Plastic, "Green" Molding Compound. UL Flammability Classification Rating 94V-0
- Moisture Sensitivity: Level 1 per J-STD-020
- Terminals: Matte Tin Finish annealed over Alloy 42 leadframe (Lead Free Plating). Solderable per MIL-STD-202, Method 208 <sup>e3</sup>
- Weight: 0.008 grams (approximate)

SOT23



Top View

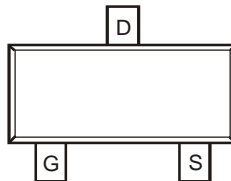

Top View  
Pin Out Configuration

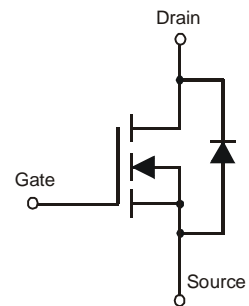

Equivalent Circuit

## Ordering Information (Note 4)

Part Number	Case	Packaging
2N7002E-7-F	SOT23	3,000/Tape & Reel
2N7002E-13-F	SOT23	10,000/Tape & Reel

- Notes:
1. No purposely added lead. Fully EU Directive 2002/95/EC (RoHS) & 2011/65/EU (RoHS 2) compliant
  2. See [http://www.diodes.com/quality/lead\\_free.html](http://www.diodes.com/quality/lead_free.html) for more information about Diodes Incorporated's definitions of Halogen- and Antimony-free, "Green" and Lead-free.
  3. Halogen- and Antimony-free "Green" products are defined as those which contain <900ppm bromine, <900ppm chlorine (<1500ppm total Br + Cl) and <1000ppm antimony compounds.
  4. For packaging details, go to our website at <http://www.diodes.com/products/packages.html>.

## Marking Information

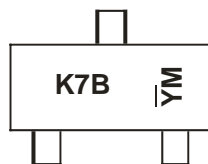

Chengdu A/T Site

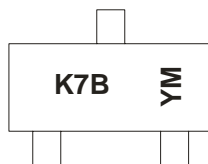

Shanghai A/T Site

K7B = Product Type Marking Code  
 YM = Date Code Marking for SAT (Shanghai Assembly/ Test site)  
 YM = Date Code Marking for CAT (Chengdu Assembly/ Test site)  
 Y or Y= Year (ex: A = 2013)  
 M = Month (ex: 9 = September)

### Date Code Key

Year	2003	2004	2005	2006	2007	2008	2009	2010	2011	2012	2013	2014	2015	2016	2017
Code	P	R	S	T	U	V	W	X	Y	Z	A	B	C	D	E

Month	Jan	Feb	Mar	Apr	May	Jun	Jul	Aug	Sep	Oct	Nov	Dec
Code	1	2	3	4	5	6	7	8	9	O	N	D

**Maximum Ratings** (@T<sub>A</sub> = +25°C, unless otherwise specified.)

Characteristic			Symbol	Value	Units
Drain-Source Voltage			V <sub>DSS</sub>	60	V
Drain-Gate Voltage R <sub>GS</sub> ≤ 1.0MΩ			V <sub>DGR</sub>	60	V
Gate-Source Voltage			V <sub>GSS</sub>	±20	V
Continuous Pulsed				±40	
Continuous Drain Current (Note 5) V <sub>GS</sub> = 10V	Steady State	T <sub>A</sub> = +25°C	I <sub>D</sub>	250	mA
		T <sub>A</sub> = +70°C		200	
Continuous Drain Current (Note 6) V <sub>GS</sub> = 10V	Steady State	T <sub>A</sub> = +25°C	I <sub>D</sub>	300	mA
		T <sub>A</sub> = +70°C		240	
Maximum Body Diode Forward Current (Note 6)			I <sub>S</sub>	500	mA
Pulsed Drain Current (10μs pulse, duty cycle = 1%)			I <sub>DM</sub>	800	mA

**Thermal Characteristics** (@T<sub>A</sub> = +25°C, unless otherwise specified.)

Characteristic		Symbol	Value	Units
Total Power Dissipation	(Note 5)	P <sub>D</sub>	370	mW
	(Note 6)		540	
Thermal Resistance, Junction to Ambient	(Note 5)	R <sub>θJA</sub>	348	°C/W
	(Note 6)		241	
Thermal Resistance, Junction to Case	(Note 6)	R <sub>θJC</sub>	91	
Operating and Storage Temperature Range		T <sub>J</sub> , T <sub>STG</sub>	-55 to 150	°C

**Electrical Characteristics** (@T<sub>A</sub> = +25°C, unless otherwise specified.)

Characteristic	Symbol	Min	Typ	Max	Unit	Test Condition
<b>OFF CHARACTERISTICS (Note 7)</b>						
Drain-Source Breakdown Voltage	BV <sub>DSS</sub>	60	70	—	V	V <sub>GS</sub> = 0V, I <sub>D</sub> = 10μA
Zero Gate Voltage Drain Current	I <sub>DSS</sub>	—	—	1.0	μA	V <sub>DS</sub> = 60V, V <sub>GS</sub> = 0V
@ T <sub>C</sub> = +25°C				500		
Gate-Body Leakage	I <sub>GSS</sub>	—	—	±10	nA	V <sub>GS</sub> = ±15V, V <sub>DS</sub> = 0V
<b>ON CHARACTERISTICS (Note 7)</b>						
Gate Threshold Voltage	V <sub>GS(th)</sub>	1.0	—	2.5	V	V <sub>DS</sub> = V <sub>GS</sub> , I <sub>D</sub> = 250μA
Static Drain-Source On-Resistance	R <sub>DS(ON)</sub>	—	1.6	3	Ω	V <sub>GS</sub> = 10V, I <sub>D</sub> = 250mA V <sub>GS</sub> = 4.5V, I <sub>D</sub> = 200mA
@ T <sub>J</sub> = +25°C			2.0	4		
On-State Drain Current	I <sub>D(ON)</sub>	0.8	1.0	—	A	V <sub>GS</sub> = 10V, V <sub>DS</sub> = 7.5V
Forward Transconductance	g <sub>FS</sub>	80	—	—	mS	V <sub>DS</sub> = 10V, I <sub>D</sub> = 0.2A
<b>DYNAMIC CHARACTERISTICS (Note 8)</b>						
Input Capacitance	C <sub>iss</sub>	—	22	50	pF	V <sub>DS</sub> = 25V, V <sub>GS</sub> = 0V, f = 1.0MHz
Output Capacitance	C <sub>oss</sub>	—	11	25	pF	
Reverse Transfer Capacitance	C <sub>rss</sub>	—	2.0	5.0	pF	
Gate resistance	R <sub>g</sub>	—	120	—	Ω	V <sub>DS</sub> = 0V, V <sub>GS</sub> = 0V, f = 1.0MHz
Total Gate Charge (V <sub>GS</sub> = 4.5V)	Q <sub>g</sub>	—	223	—	pC	V <sub>DS</sub> = 10V, I <sub>D</sub> = 250mA
Gate-Source Charge	Q <sub>gs</sub>	—	82	—	pC	
Gate-Drain Charge	Q <sub>gd</sub>	—	178	—	pC	
<b>SWITCHING CHARACTERISTICS (Note 8)</b>						
Turn-On Delay Time	t <sub>D(ON)</sub>	—	7.0	20	ns	V <sub>DD</sub> = 30V, I <sub>D</sub> = 0.2A, R <sub>L</sub> = 150Ω, V <sub>GEN</sub> = 10V, R <sub>GEN</sub> = 25Ω
Turn-Off Delay Time	t <sub>D(OFF)</sub>	—	11	20	ns	

- Notes: 5. Device mounted on FR-4 PCB, with minimum recommended pad layout.  
6. Device mounted on 1" x 1" FR-4 PCB with high coverage 2oz. Copper, single sided.  
7. Short duration pulse test used to minimize self-heating effect.  
8. Guaranteed by design. Not subject to product testing.

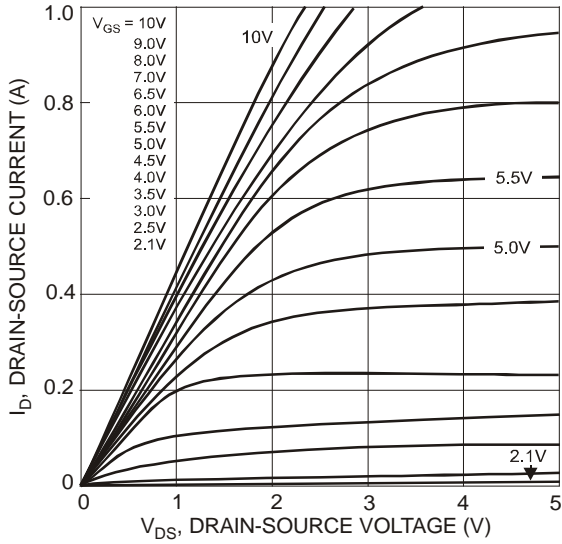

Fig. 1 On-Region Characteristics

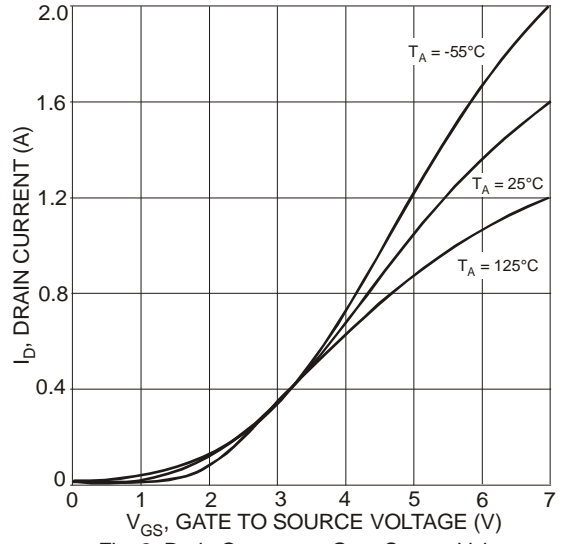

Fig. 2 Drain Current vs. Gate-Source Voltage

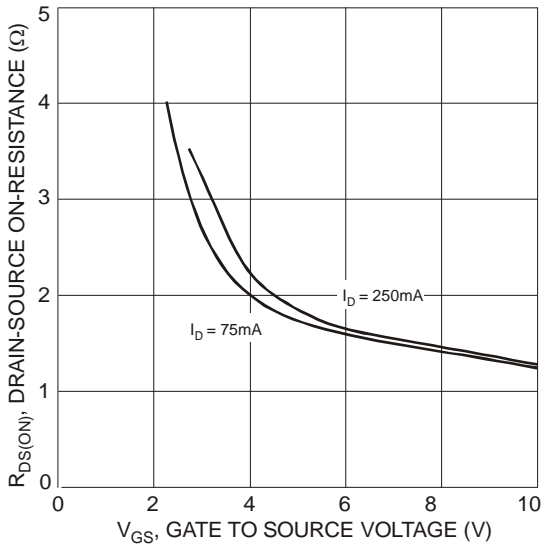

Fig. 3 On Resistance vs. Gate-Source Voltage

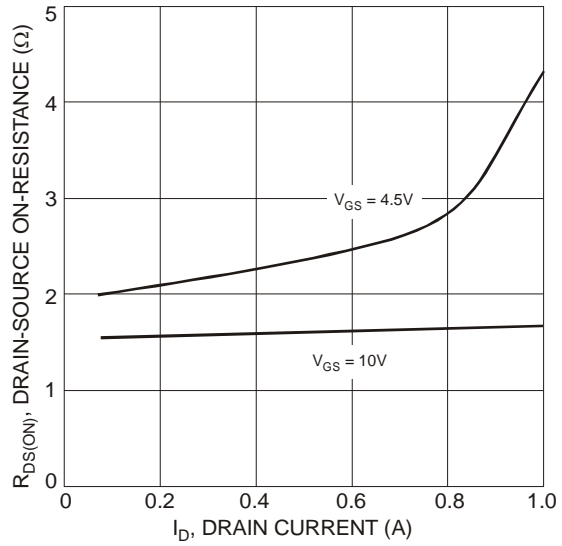

Fig. 4 On Resistance vs. Drain Current

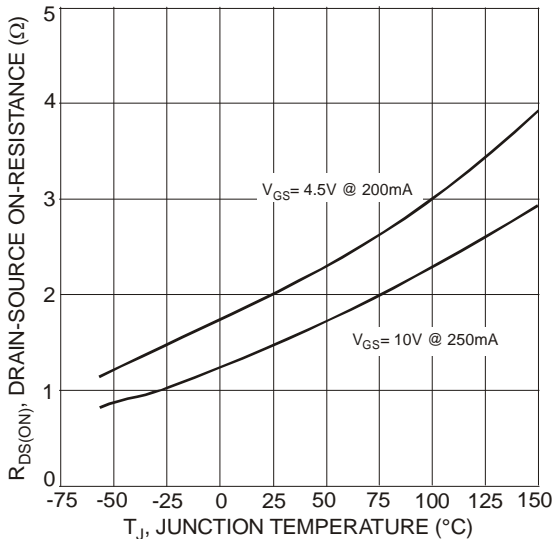

Fig. 5 On-Resistance vs. Junction Temperature

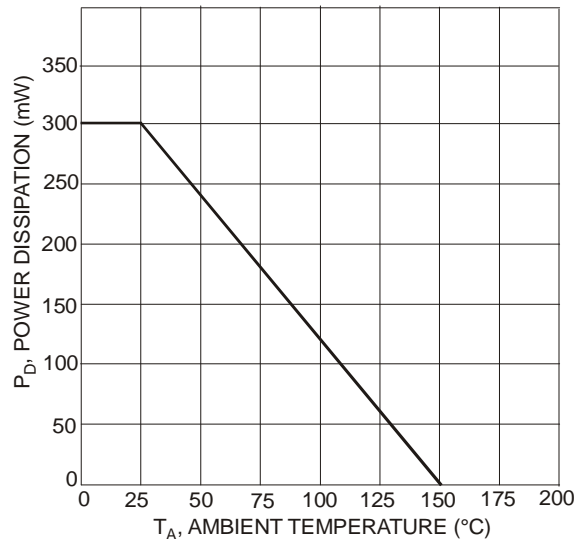
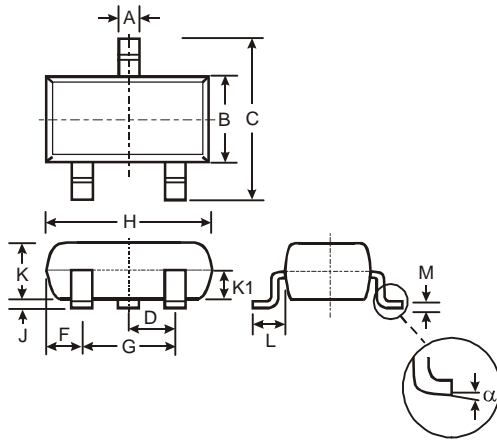

Fig. 6 Max Power Dissipation vs. Ambient Temperature

**Package Outline Dimensions**

Please see AP02001 at <http://www.diodes.com/datasheets/ap02001.pdf> for the latest version.



SOT23			
Dim	Min	Max	Typ
A	0.37	0.51	0.40
B	1.20	1.40	1.30
C	2.30	2.50	2.40
D	0.89	1.03	0.915
F	0.45	0.60	0.535
G	1.78	2.05	1.83
H	2.80	3.00	2.90
J	0.013	0.10	0.05
K	0.903	1.10	1.00
K1	-	-	0.400
L	0.45	0.61	0.55
M	0.085	0.18	0.11
α	0°	8°	-
All Dimensions in mm			

**Suggested Pad Layout**

Please see AP02001 at <http://www.diodes.com/datasheets/ap02001.pdf> for the latest version.

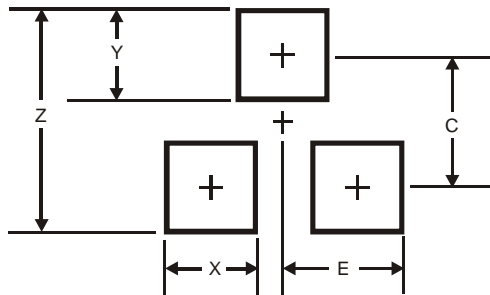

Dimensions	Value (in mm)
Z	2.9
X	0.8
Y	0.9
C	2.0
E	1.35

**IMPORTANT NOTICE**

DIODES INCORPORATED MAKES NO WARRANTY OF ANY KIND, EXPRESS OR IMPLIED, WITH REGARDS TO THIS DOCUMENT, INCLUDING, BUT NOT LIMITED TO, THE IMPLIED WARRANTIES OF MERCHANTABILITY AND FITNESS FOR A PARTICULAR PURPOSE (AND THEIR EQUIVALENTS UNDER THE LAWS OF ANY JURISDICTION).

Diodes Incorporated and its subsidiaries reserve the right to make modifications, enhancements, improvements, corrections or other changes without further notice to this document and any product described herein. Diodes Incorporated does not assume any liability arising out of the application or use of this document or any product described herein; neither does Diodes Incorporated convey any license under its patent or trademark rights, nor the rights of others. Any Customer or user of this document or products described herein in such applications shall assume all risks of such use and will agree to hold Diodes Incorporated and all the companies whose products are represented on Diodes Incorporated website, harmless against all damages.

Diodes Incorporated does not warrant or accept any liability whatsoever in respect of any products purchased through unauthorized sales channel. Should Customers purchase or use Diodes Incorporated products for any unintended or unauthorized application, Customers shall indemnify and hold Diodes Incorporated and its representatives harmless against all claims, damages, expenses, and attorney fees arising out of, directly or indirectly, any claim of personal injury or death associated with such unintended or unauthorized application.

Products described herein may be covered by one or more United States, international or foreign patents pending. Product names and markings noted herein may also be covered by one or more United States, international or foreign trademarks.

This document is written in English but may be translated into multiple languages for reference. Only the English version of this document is the final and determinative format released by Diodes Incorporated.

**LIFE SUPPORT**

Diodes Incorporated products are specifically not authorized for use as critical components in life support devices or systems without the express written approval of the Chief Executive Officer of Diodes Incorporated. As used herein:

A. Life support devices or systems are devices or systems which:

1. are intended to implant into the body, or
2. support or sustain life and whose failure to perform when properly used in accordance with instructions for use provided in the labeling can be reasonably expected to result in significant injury to the user.

B. A critical component is any component in a life support device or system whose failure to perform can be reasonably expected to cause the failure of the life support device or to affect its safety or effectiveness.

Customers represent that they have all necessary expertise in the safety and regulatory ramifications of their life support devices or systems, and acknowledge and agree that they are solely responsible for all legal, regulatory and safety-related requirements concerning their products and any use of Diodes Incorporated products in such safety-critical, life support devices or systems, notwithstanding any devices- or systems-related information or support that may be provided by Diodes Incorporated. Further, Customers must fully indemnify Diodes Incorporated and its representatives against any damages arising out of the use of Diodes Incorporated products in such safety-critical, life support devices or systems.

Copyright © 2013, Diodes Incorporated

[www.diodes.com](http://www.diodes.com)