



Description

The S642-X is a bi-directional, single-pole, single-throw, normally open multipurpose solid-state relay. The circuit is composed of one input IR LED with a series limiting resistor which activates an optically coupled IC on the output that controls the firing angle of two back-to-back SCRs. This circuit assures no false triggering under most adverse conditions, and a tight zero-volt switching window not exceeding 5V. The S642-X provides high peak load voltage (400V+) and high input-to-output isolation voltage (up to 5kV_{RMS}).

The S642-X comes in a compact 16 pin DIP package, making it ideal for high-density board applications.

Applications

- Valve Control
- Solenoid Control
- Home Appliances
- Metering Equipment
- Heating Elements
- Gas Pump Control Circuitry

Schematic Diagram

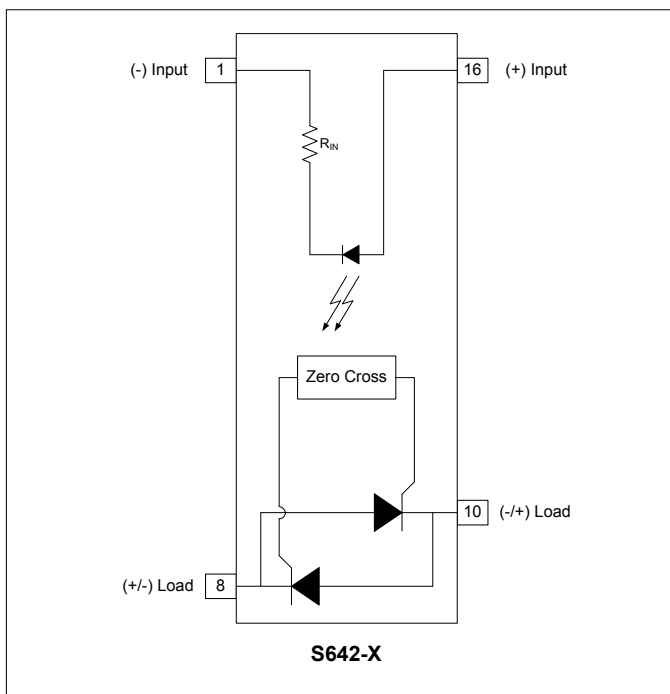

Features

- Zero-Volt Cross Switching
- Input Series Limiting Resistor (300Ω TYP)
- High Blocking Voltage (400V MIN)
- High Transient Immunity
- 1.2A Maximum Continuous Current
- Low Input Control Current
- Long Life / High Reliability
- RoHS / Pb-Free / REACH Compliant

Agency Approvals

UL/C-UL: File # E90096
 VDE: File # 40035191 (EN 60747-5-2)

Absolute Maximum Ratings

The values indicated are absolute stress ratings. Functional operation of the device is not implied at these or any conditions in excess of those defined in electrical characteristics section of this document. Exposure to absolute Maximum Ratings may cause permanent damage to the device and may adversely affect reliability.

Storage Temperature-55 to +125°C
 Operating Temperature-40 to +85°C
 Continuous Input Current50mA
 Transient Input Current500mA
 Reverse Input Control Voltage5V
 Input Power Dissipation40mW
 Total Power Dissipation1.2W
 Solder Temperature – Wave (10sec).....260°C
 Solder Temperature – IR Reflow (10sec).....260°C

Ordering Information

Part Number	Description
S642-X	16 pin DIP, (25/Tube)
S642-XH	5kV _{RMS} V _{ISO} , 16 pin DIP, (25/Tube)
S642-XS	16 pin SMD, (25/Tube)
S642-XHS	5kV _{RMS} V _{ISO} , 16 pin SMD, (25/Tube)

NOTE: Suffixes listed above are not included in marking on device for part number identification

Electrical Characteristics, $T_A = 25^\circ\text{C}$ (unless otherwise specified)

Parameter	Symbol	Min.	Typ.	Max.	Units	Test Conditions
Input Specifications						
LED Forward Voltage	V_F	-	1.2	1.5	V	$I_F = 10\text{mA}$
LED Reverse Voltage	BV_R	5	-	-	V	$I_R = 10\mu\text{A}$
Input Resistor	R_{IN}	-	300	-	Ω	
Trigger (Must Operate) Current ¹	I_F	-	3	5	mA	$I_O = I_{O(MAX)}$ [Resistive Load]
Junction Capacitance	C_J	-	5	-	pF	$I_F = 0\text{mA}$
Output Specifications						
Blocking Voltage	V_B	400	-	-	V	$I_F = 0\text{mA}$, $I_O = 1\mu\text{A}$
Continuous Load Current	$I_{O(MAX)}$	-	-	1.2	A	$I_F = 5\text{mA}$
Surge Current	$I_{(SURGE)}$	-	-	10	A	$T \leq 16\text{mS}$
Holding Current	I_{HOLD}	-	-	10	mA	$I_F = 5\text{mA}$
On Voltage	V_{ON}	-	-	1.2	V	$I_F = 5\text{mA}$, $I_O = 1.2\text{A}$
Voltage Across Load at Turn On	-	-	-	5	V	$I_F = 5\text{mA}$
Leakage Current	I_{leak}	-	100	250	μA	$I_F = 0\text{mA}$, $V_O = 250\text{V}$
Thermal Resistance	-	-	80	-	$^\circ\text{C/W}$	
Power Factor ²	-	-	0.3	-	-	
Critical Rate of Rise (dV/dt) ³	dV/dt	400	-	-	V/ μS	
Coupled Specifications						
Turn-On Time	T_{ON}	-	-	0.5	Cycles	$I_F = 5\text{mA}$
Turn-Off Time	T_{OFF}	-	-	0.5	Cycles	$I_F = 5\text{mA}$
Coupled Capacitance	$C_{COUPLED}$	-	2	-	pF	
Contact Transient Ratio	-	2,000	7,000	0	V/ μS	dV = 50V
Isolation Specifications						
Isolation Voltage (-H Option)	V_{ISO}	3750 5000	- -	- -	V_{RMS}	$RH \leq 50\%$, $t=1\text{min}$
Input-Output Resistance	R_{I-O}	-	10^{12}	-	Ω	$V_{I-O} = 500V_{DC}$

NOTES:

- 1) Resistive load. For inductive loads, higher drive current is recommended
- 2) Snubber circuits may be required for lower power factors
- 3) This is for static dV/dt.

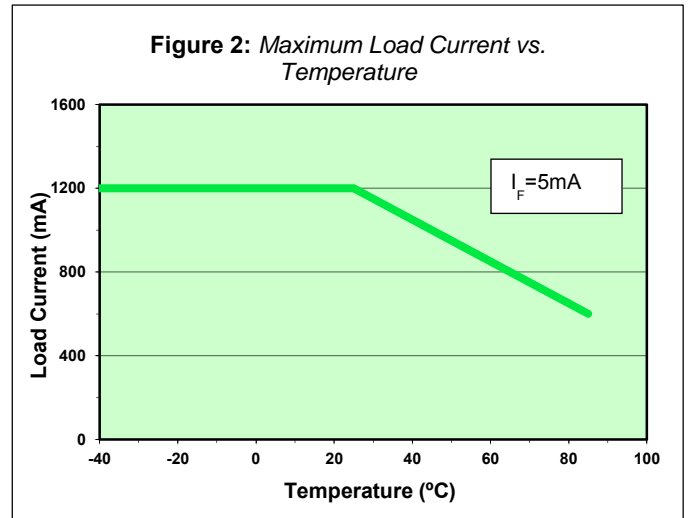
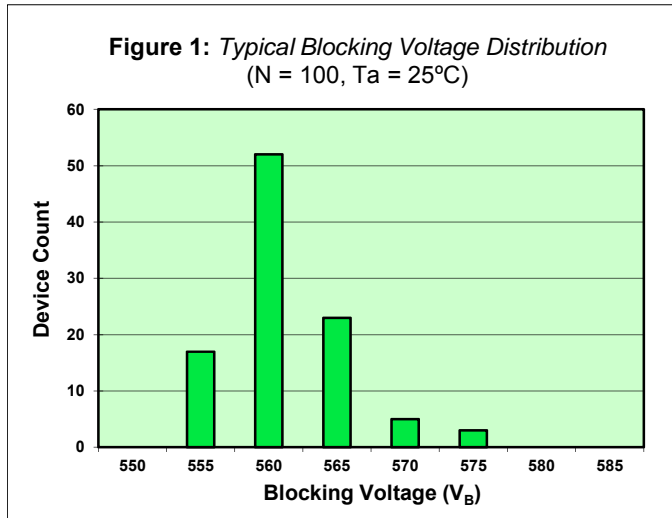
S642-X Performance & Characteristics Plots, $T_A = 25^\circ\text{C}$ (unless otherwise specified)

ZERO-VOLT SWITCHING

This solid state relay has been designed with a driver circuit that controls the operation of two back-to-back silicon controlled rectifiers (SCRs), each responsible for one half of the AC cycle. If an AC signal is examined, the turn on, turn off and zero-volt switching can be seen. Figure 3 shows a typical 60 HZ, 120VAC signal with a corresponding relay input signal:

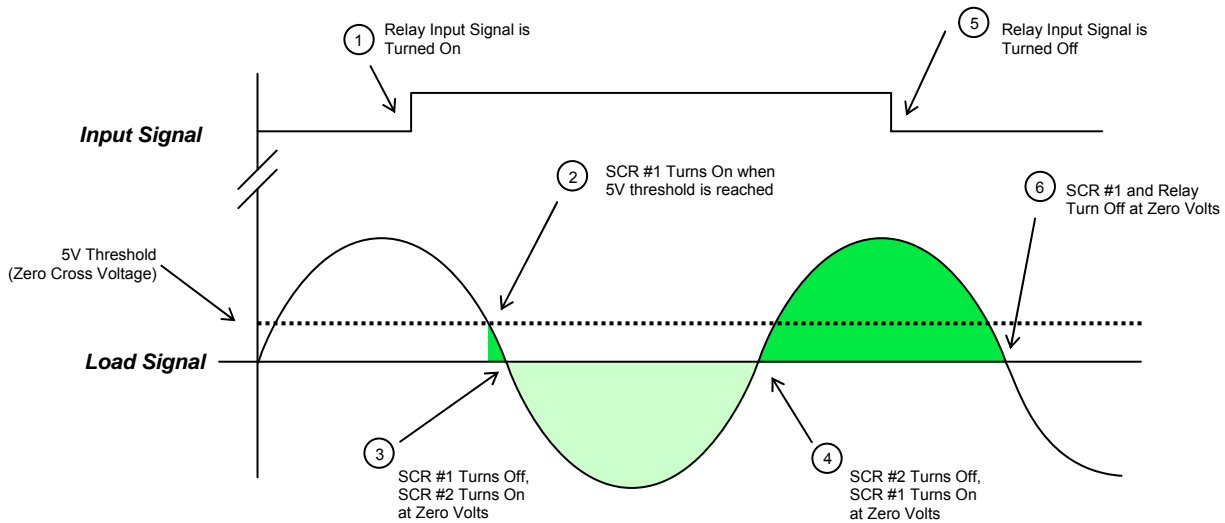
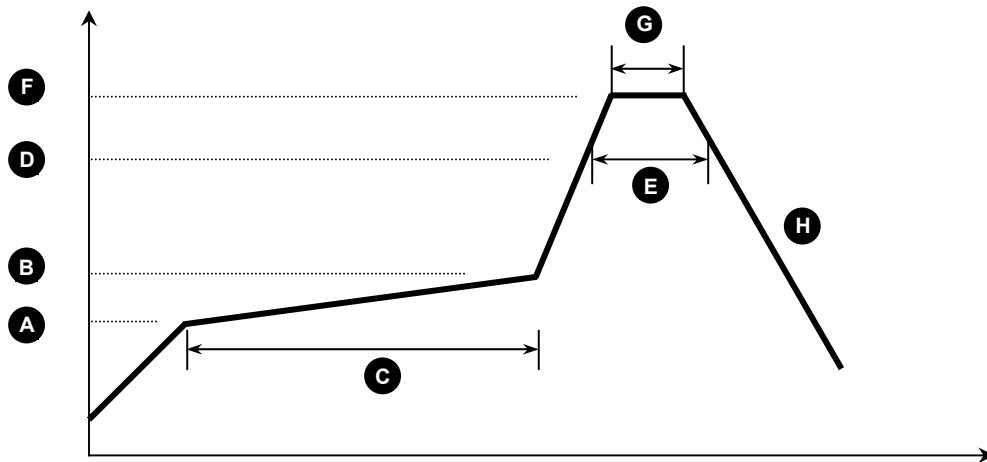

Figure 3: Zero-Volt Switching Cycle

Figure 3 shows the sequence of zero-volt switching operation. At Stage 1, an input signal is applied to the relay. The relay will not turn on until the threshold voltage of 5V is reached. Once this point is reached (Stage 2), SCR #1 (designated as the SCR which controls positive AC voltage) turns on. However, SCR #1 only conducts for an instant, as the cycle quickly crosses zero. At this point (Stage 3), SCR #1 will turn off and SCR #2 (negative AC voltage) turns on. Likewise, at the next zero cross (Stage 4), SCR #2 will turn off and SCR #1 conducts again. Even though the input signal is terminated at Stage 5, the relay will continue to conduct (typical SCR behavior) until Stage 6, when SCR #1 crosses zero and ceases to conduct. Please note that turn on can likewise begin on the negative phase of the AC cycle with a -5V threshold, though only the positive phase is shown here.

S642-X Solder Reflow Temperature Profile Recommendations
(1) Infrared Reflow:

Refer to the following figure as an example of an optimal temperature profile for single occurrence infrared reflow. Soldering process should not exceed temperature or time limits expressed herein. Surface temperature of device package should not exceed 250°C:



Process Step	Description	Parameter
A	Preheat Start Temperature (°C)	150°C
B	Preheat Finish Temperature (°C)	180°C
C	Preheat Time (s)	90 - 120s
D	Melting Temperature (°C)	230°C
E	Time above Melting Temperature (s)	30s
F	Peak Temperature, at Terminal (°C)	260°C
G	Dwell Time at Peak Temperature (s)	10s
H	Cool-down (°C/s)	<6°C/s

(2) Wave Solder:

Maximum Temperature: 260°C (at terminal)
 Maximum Time: 10s
 Pre-heating: 100 - 150°C (30 - 90s)
 Single Occurrence

(3) Hand Solder:

Maximum Temperature: 350°C (at tip of soldering iron)
 Maximum Time: 3s
 Single Occurrence

S642-X Package Dimensions

16 PIN DIP Package

Note: All dimensions in inches ["] with millimeters in parenthesis ()

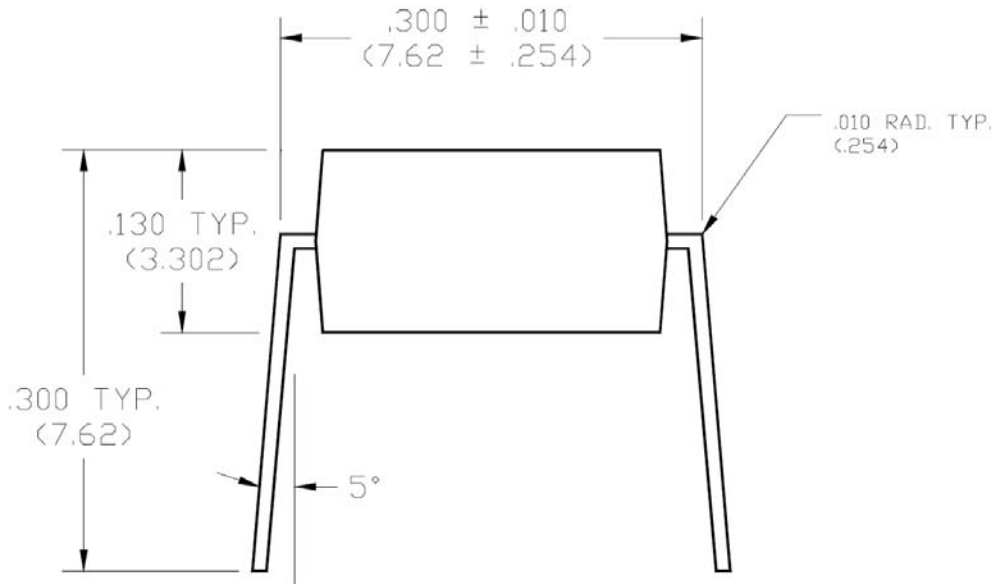

END VIEW

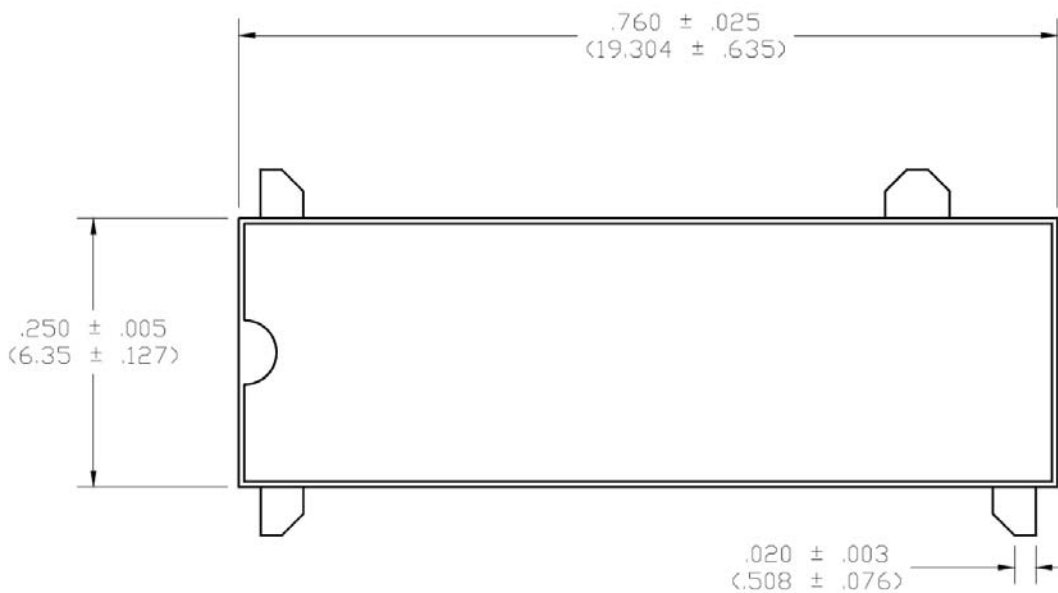

TOP VIEW

S642-X Package Dimensions

16 PIN SMD Package (-S)

Note: All dimensions in inches ["] with millimeters in parenthesis ()

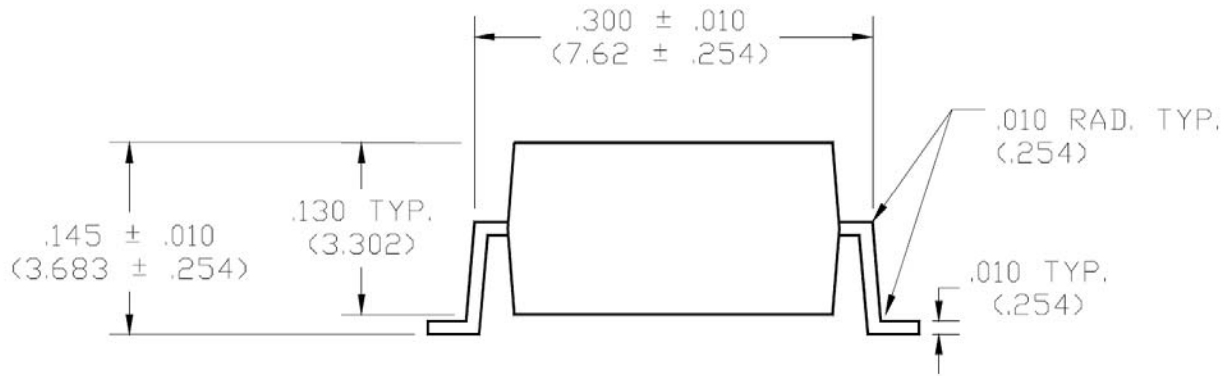

END VIEW

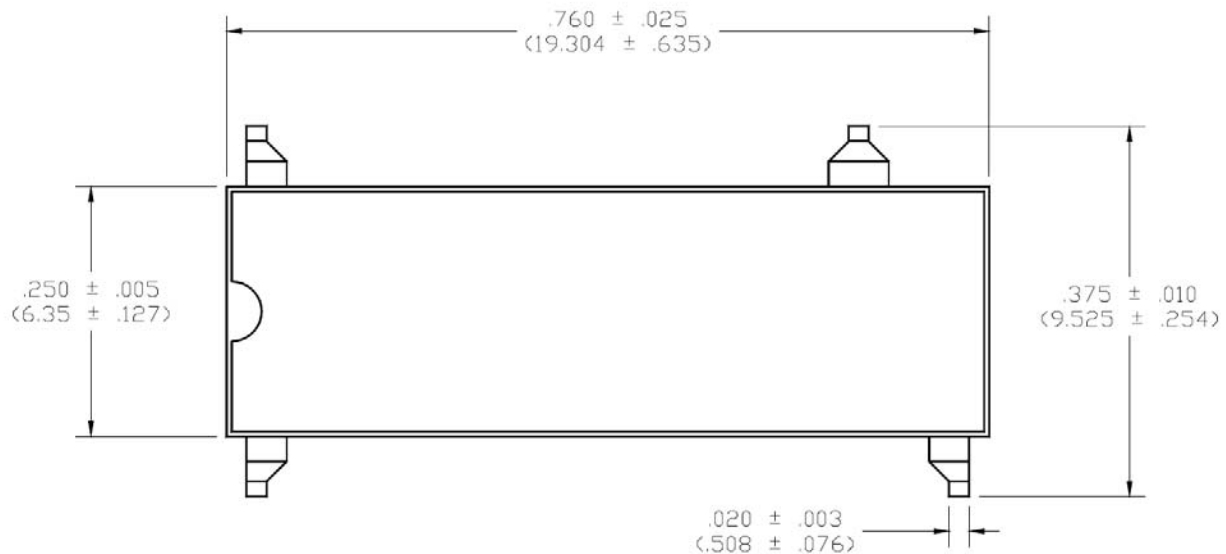

TOP VIEW

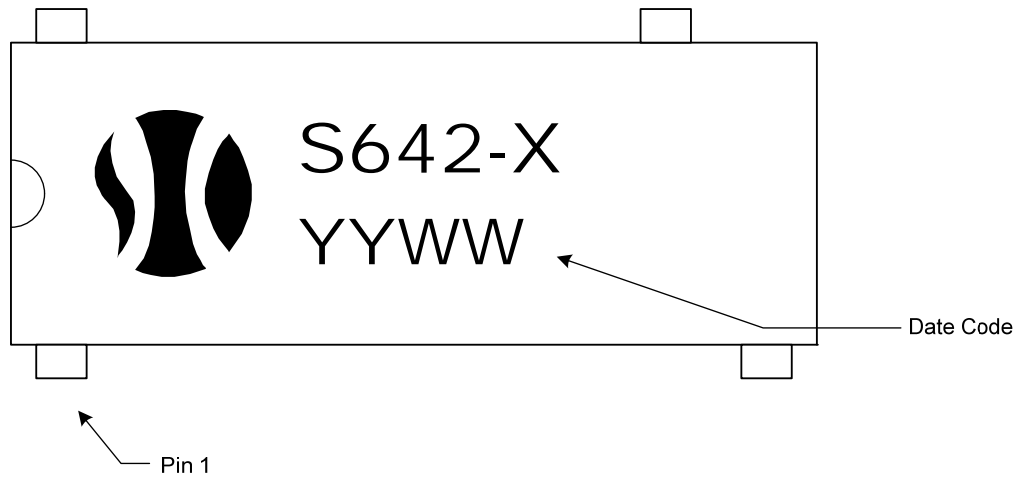
S642-X Package Marking

S642-X Package Weights

Device	Single Unit	Full Tube (25pcs)	Full Pouch (10 tubes)
S642-X(H)	0.88	35	370
S642-X(H)S	0.88	35	370

Note: All weights above are in GRAMS, and include packaging materials where applicable

DISCLAIMER

Solid State Optronics (SSO) makes no warranties or representations with regards to the completeness and accuracy of this document. SSO reserves the right to make changes to product description, specifications at any time without further notices. SSO shall not assume any liability arising out of the application or use of any product or circuit described herein. Neither circuit patent licenses nor indemnity are expressed or implied. Except as specified in SSO's Standard Terms & Conditions, SSO disclaims liability for consequential or other damage, and we make no other warranty, expressed or implied, including merchantability and fitness for particular use.

LIFE SUPPORT POLICY

SSO does not authorize use of its devices in life support applications wherein failure or malfunction of a device may lead to personal injury or death. Users of SSO devices in life support applications assume all risks of such use and agree to indemnify SSO against any and all damages resulting from such use. Life support devices are defined as devices or systems which, (a) are intended for surgical implant into the body, or (b) support or sustain life, and (c) whose failure to perform when used properly in accordance with instructions for use can be reasonably expected to result in significant injury to the user, or (d) a critical component of a life support device or system whose failure can be reasonably expected to cause failure of the life support device or system, or to affect its safety or effectiveness.