

Features

- 100V/32A,
 $R_{DS(ON)} = 34m$ (Typ.) @ $V_{GS} = 10V$
- Super High Dense Cell Design
- Ultra Low On-Resistance
- 100% avalanche tested
- Lead Free and Green Devices Available
 (RoHS Compliant)

Applications

- DC-DC Converters
- Synchronous Rectifier

Pin Description

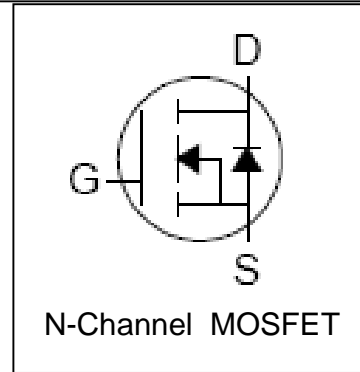
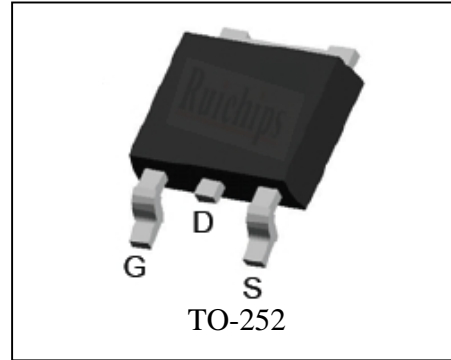

Absolute Maximum Ratings

Symbol	Parameter	Rating	Unit
Common Ratings ($T_C = 25^\circ C$ Unless Otherwise Noted)			
V_{DSS}	Drain-Source Voltage	100	V
V_{GSS}	Gate-Source Voltage	± 20	
T_J	Maximum Junction Temperature	175	$^\circ C$
T_{STG}	Storage Temperature Range	-55 to 175	$^\circ C$
I_S	Diode Continuous Forward Current	$T_C = 25^\circ C$ 32	A
Mounted on Large Heat Sink			
I_{DP}	300 μs Pulse Drain Current Tested	$T_C = 25^\circ C$ 128 ^①	A
I_D	Continuous Drain Current ($V_{GS} = 10V$)	$T_C = 25^\circ C$ 32	A
		$T_C = 100^\circ C$ 23	
P_D	Maximum Power Dissipation	$T_C = 25^\circ C$ 71	W
		$T_C = 100^\circ C$ 36	W
$R_{\theta JC}$	Thermal Resistance-Junction to Case	2.1	$^\circ C/W$
Drain-Source Avalanche Ratings			
E_{AS} ^②	Avalanche Energy, Single Pulsed	64	mJ

Electrical Characteristics ($T_C=25^\circ\text{C}$ Unless Otherwise Noted)

Symbol	Parameter	Test Condition	RU1H36L			Unit
			Min.	Typ.	Max.	
Static Characteristics						
BV_{DSS}	Drain-Source Breakdown Voltage	$V_{GS}=0V, I_{DS}=250\mu A$	100			V
I_{DSS}	Zero Gate Voltage Drain Current	$V_{DS}=100V, V_{GS}=0V$ $T_J=85^\circ\text{C}$			1 30	μA
$V_{GS(th)}$	Gate Threshold Voltage	$V_{DS}=V_{GS}, I_{DS}=250\mu A$	2	3	4	V
I_{GSS}	Gate Leakage Current	$V_{GS}=\pm 20V, V_{DS}=0V$			± 100	nA
$R_{DS(ON)}^{(3)}$	Drain-Source On-state Resistance	$V_{GS}=10V, I_{DS}=30A$		34	40	m Ω
Diode Characteristics						
$V_{SD}^{(3)}$	Diode Forward Voltage	$I_{SD}=30A, V_{GS}=0V$			1.2	V
t_{rr}	Reverse Recovery Time	$I_{SD}=30A, di_{SD}/dt=100A/\mu s$		32		ns
Q_{rr}	Reverse Recovery Charge			45		nC
Dynamic Characteristics ⁽⁴⁾						
R_G	Gate Resistance	$V_{GS}=0V, V_{DS}=0V, F=1\text{MHz}$		1		Ω
C_{iss}	Input Capacitance	$V_{GS}=0V,$ $V_{DS}=50V,$ Frequency=1.0MHz		1600		pF
C_{oss}	Output Capacitance			230		
C_{riss}	Reverse Transfer Capacitance			95		
$t_{d(ON)}$	Turn-on Delay Time	$V_{DD}=50V, R_L=1.7\Omega,$ $I_{DS}=30A, V_{GEN}=10V,$ $R_G=4.7\Omega$		14		ns
t_r	Turn-on Rise Time			95		
$t_{d(OFF)}$	Turn-off Delay Time			53		
t_f	Turn-off Fall Time			26		
Gate Charge Characteristics ⁽⁴⁾						
Q_g	Total Gate Charge	$V_{DS}=80V, V_{GS}=10V,$ $I_{DS}=30A$		28		nC
Q_{gs}	Gate-Source Charge			9		
Q_{gd}	Gate-Drain Charge			8		

- Notes: ① Pulse width limited by safe operating area.
 ② Limited by T_{Jmax} , $I_{AS}=16A$, $V_{DD}=48V$, $R_G=50\Omega$, Starting $T_J=25^\circ\text{C}$.
 ③ Pulse test; Pulse width $\leq 300\mu s$, duty cycle $\leq 2\%$.
 ④ Guaranteed by design, not subject to production testing.

Typical Characteristics

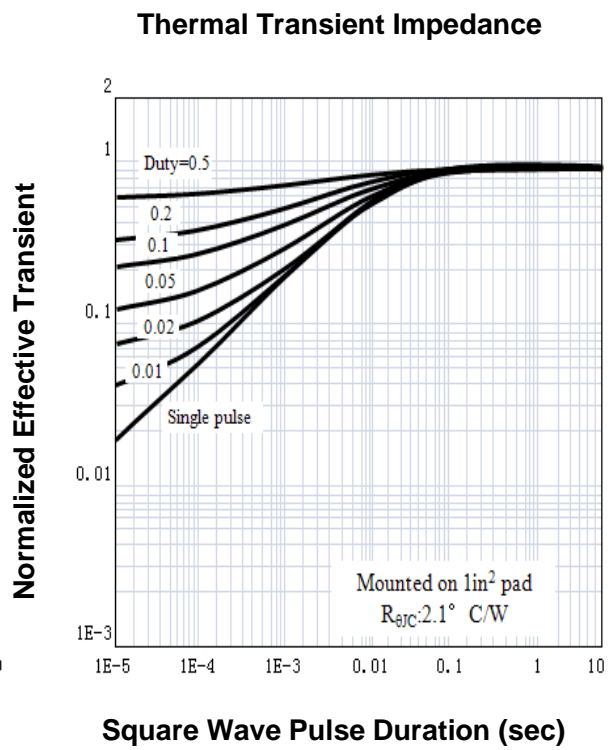
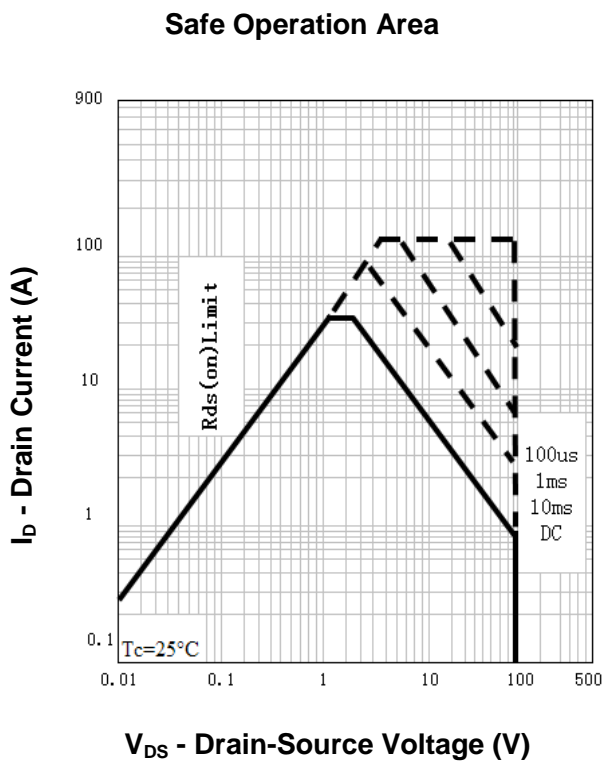
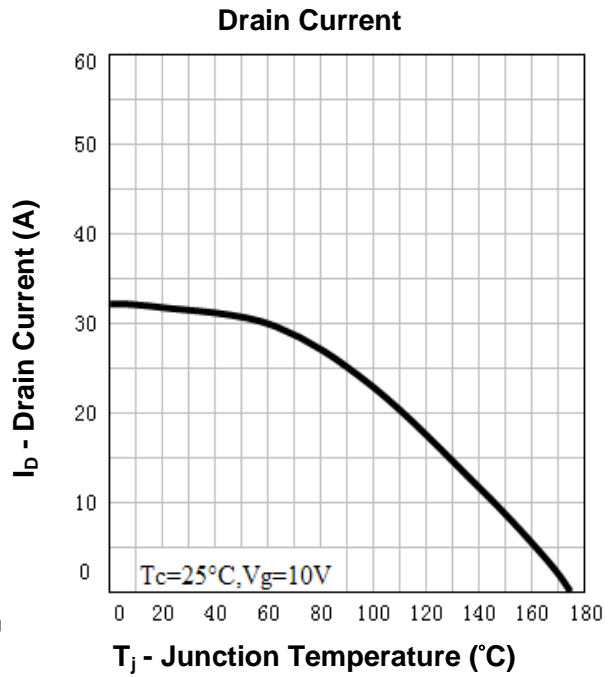
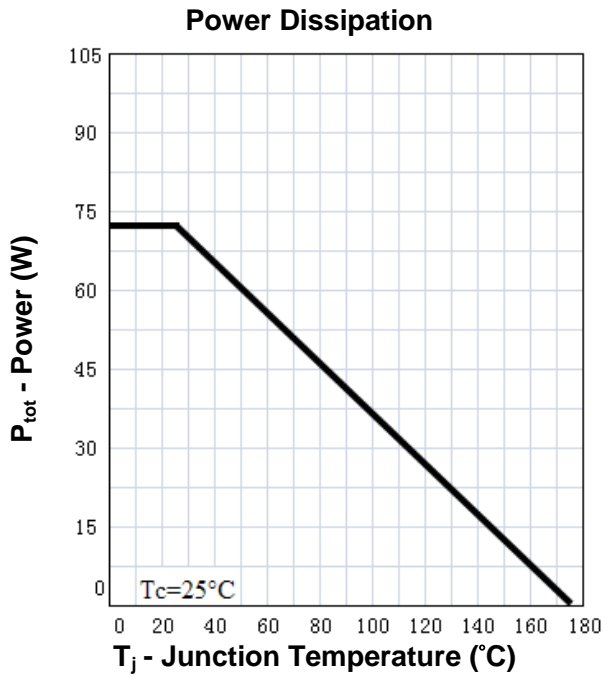

Typical Characteristics

Output Characteristics

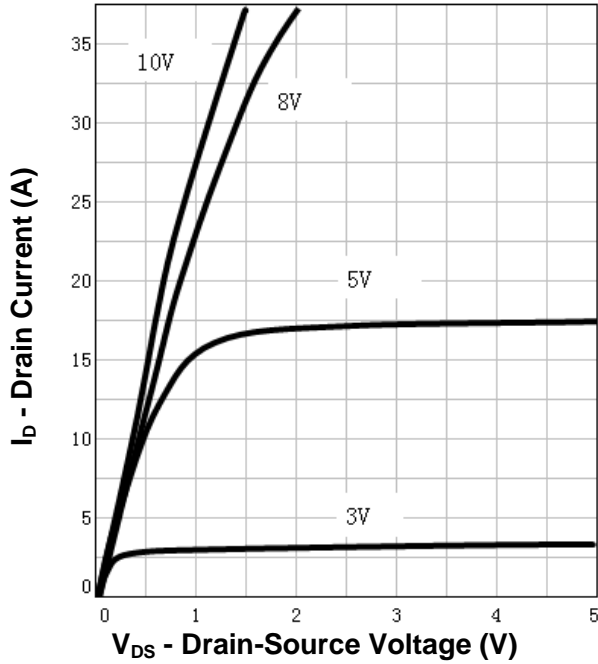

Drain-Source On Resistance

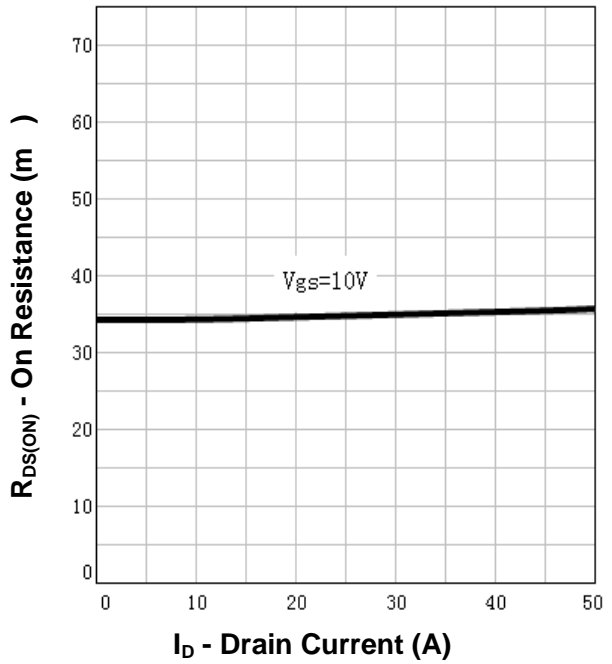

Drain-Source On Resistance

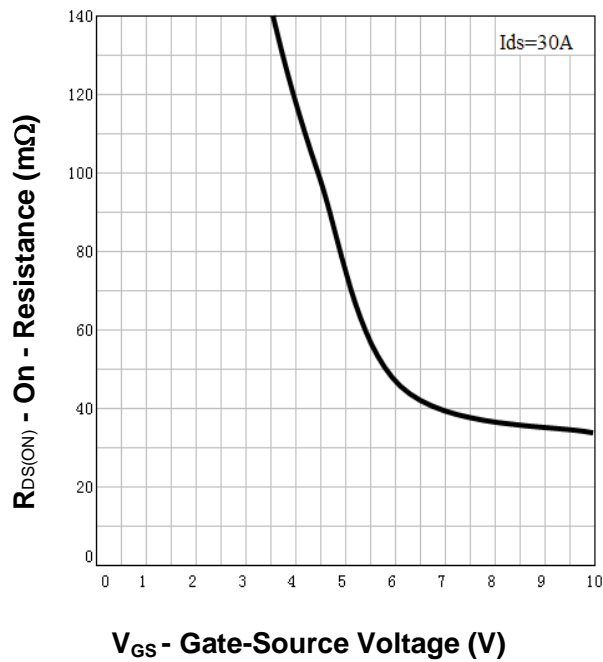

Gate Threshold Voltage

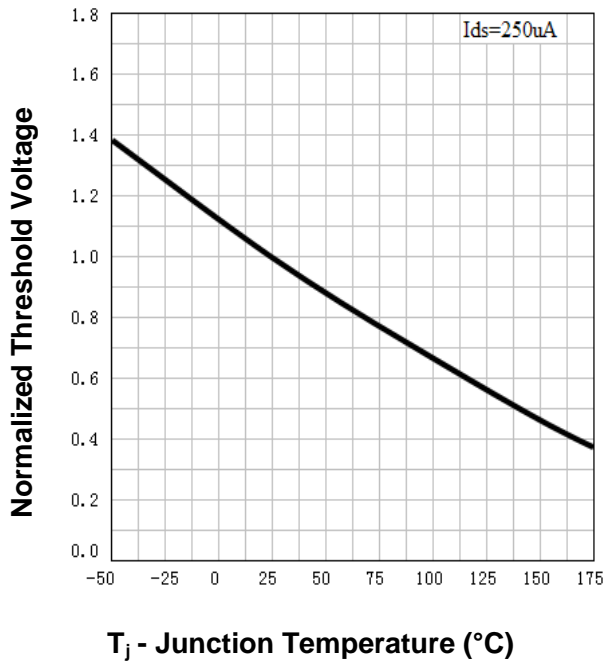

Typical Characteristics

Drain-Source On Resistance

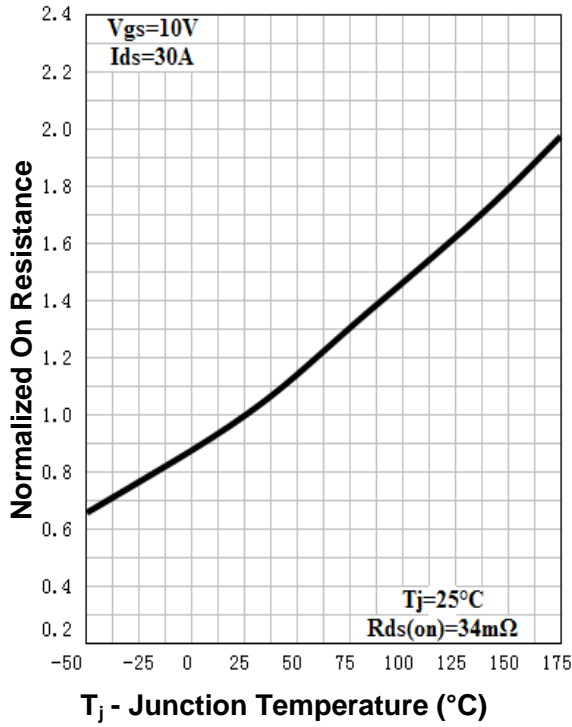

Source-Drain Diode Forward

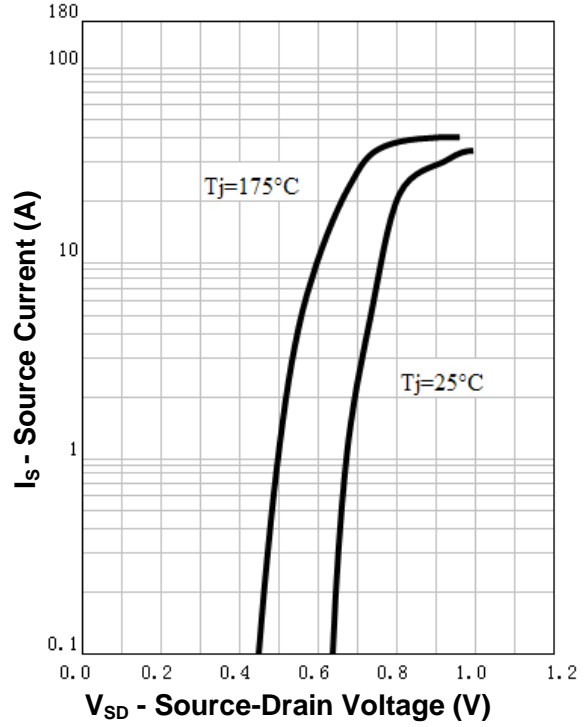

Capacitance

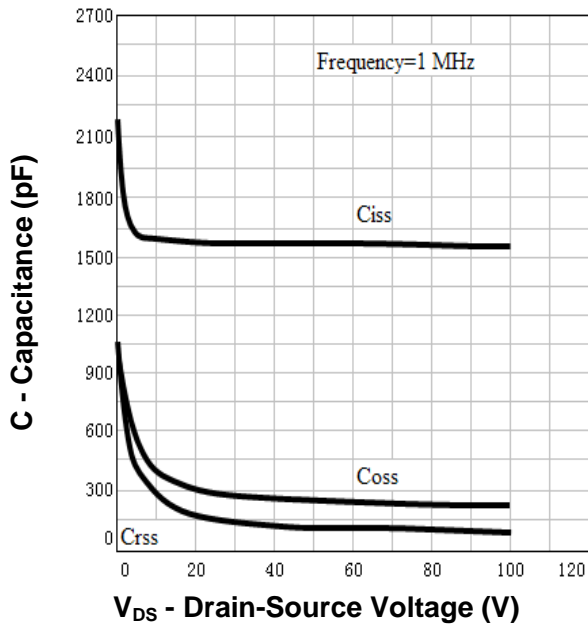

Gate Charge

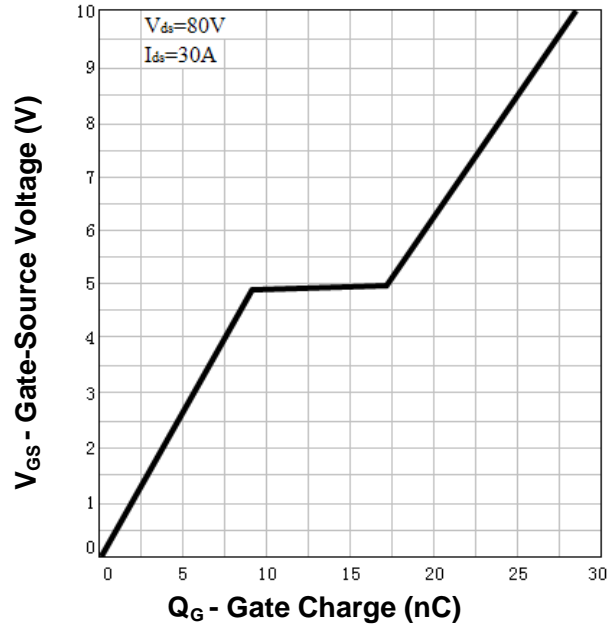

Avalanche Test Circuit and Waveforms

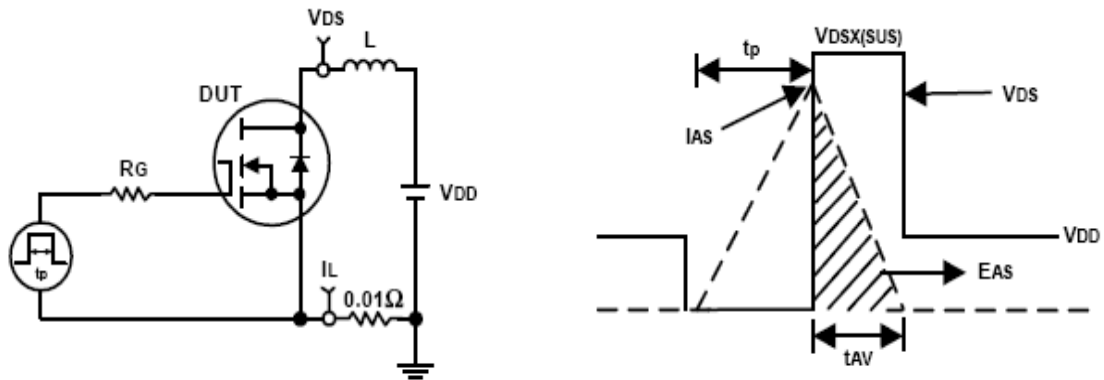

Switching Time Test Circuit and Waveforms

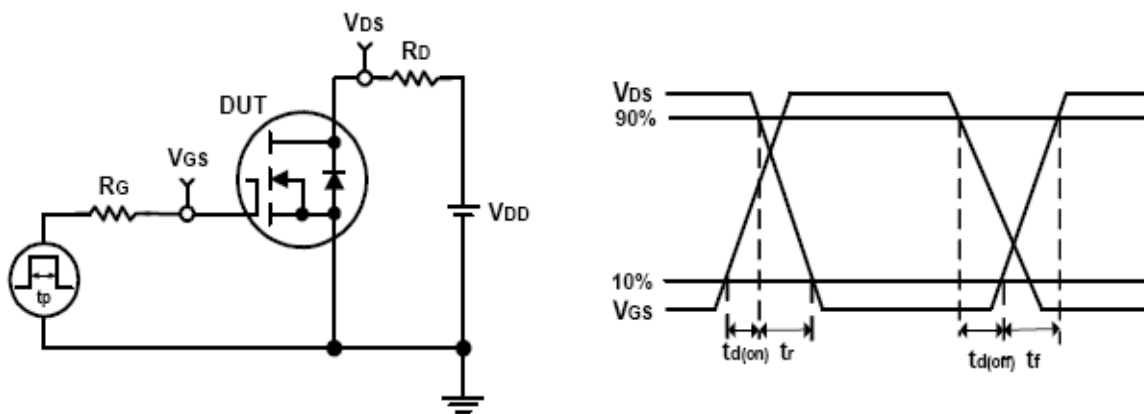

Ordering and Marking Information

Device	Marking	Package	Packaging	Quantity	Reel Size	Tape width
RU1H36L	RU1H36L	TO-252	Tape&Reel	2500	13''	16mm

Package Information

TO252-2L

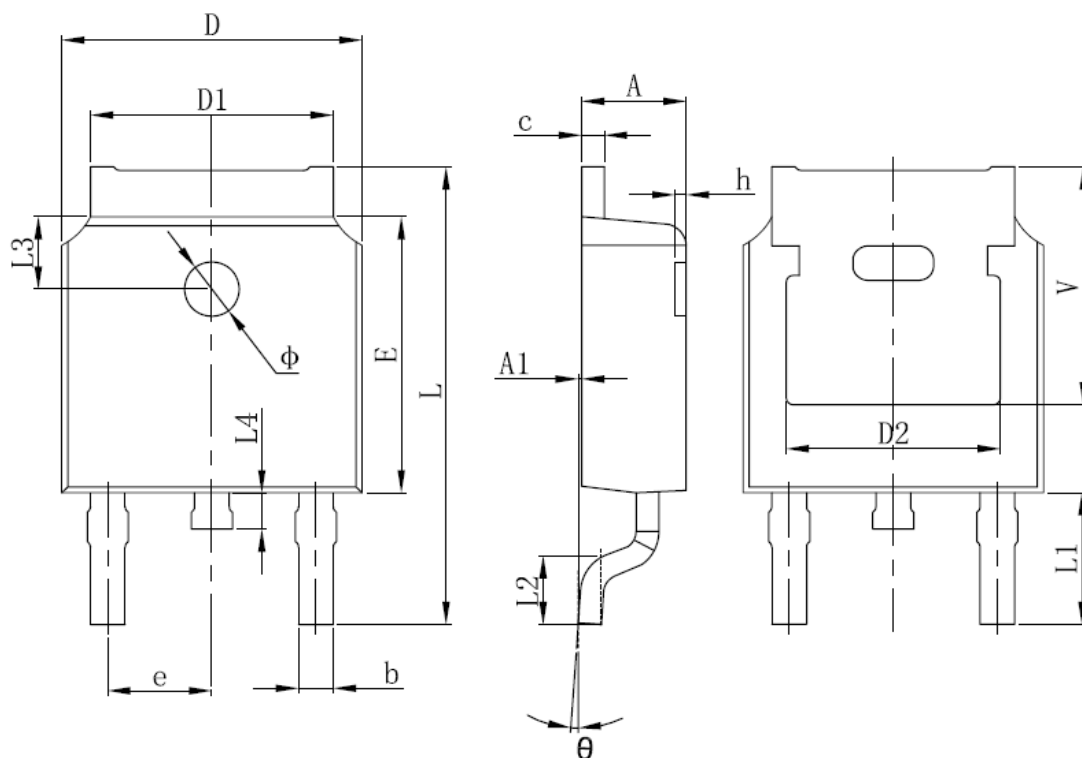

SYMBOL	MM		INCH		SYMBOL	MM		INCH	
	MIN	MAX	MIN	MAX		MIN	MAX	MIN	MAX
A	2.200	2.400	0.087	0.094	L	9.800	10.400	0.386	0.409
A1	0.000	0.127	0.000	0.005	L1	2.900 REF.		0.114 REF.	
b	0.660	0.860	0.026	0.034	L2	1.400	1.700	0.055	0.067
C	0.460	0.580	0.018	0.023	L3	1.600 REF.		0.063 REF.	
D	6.500	6.700	0.256	0.264	L4	0.600	1.000	0.024	0.039
D1	5.100	5.460	0.201	0.215	phi	1.100	1.300	0.043	0.051
D2	4.830 REF.		0.190 REF.		theta	0°	8°	0°	8°
E	6.000	6.200	0.236	0.244	h	0.000	0.300	0.000	0.012
e	2.186	2.386	0.086	0.094	V	5.350 REF.		0.211 REF.	

ALL DIMENSIONS REFER TO JEDEC STANDARD
DO NOT INCLUDE MOLD FLASH OR PROTRUSIONS

Customer Service

Worldwide Sales and Service:

Sales@ruichips.com

Technical Support:

Technical@ruichips.com

Investor Relations Contacts:

Investor@ruichips.com

Marcom Contact:

Marcom@ruichips.com

Editorial Contact:

Editorial@ruichips.com

HR Contact:

HR@ruichips.com

Legal Contact:

Legal@ruichips.com

Shen Zhen RUICHIPS Semiconductor CO., LTD

Room 501, the 5floor An Tong Industrial Building,
NO.207 Mei Hua Road Fu Tian Area Shen Zhen City, CHINA

TEL: (86-755) 8311-5334

FAX: (86-755) 8311-4278

E-mail: Sales-SZ@ruichips.com