

AM2520MGC09

MEGA GREEN

### Features

- SUBMINIATURE PACKAGE.
- WIDE VIEWING ANGLE.
- Z-BEND LEAD.
- LONG LIFE - SOLID STATE RELIABILITY.
- LOW PACKAGE PROFILE.
- PACKAGE : 1000PCS / REEL.

### Description

The Mega Green source color devices are made with DH InGaAlP on GaAs substrate Light Emitting Diode.

### Package Dimensions

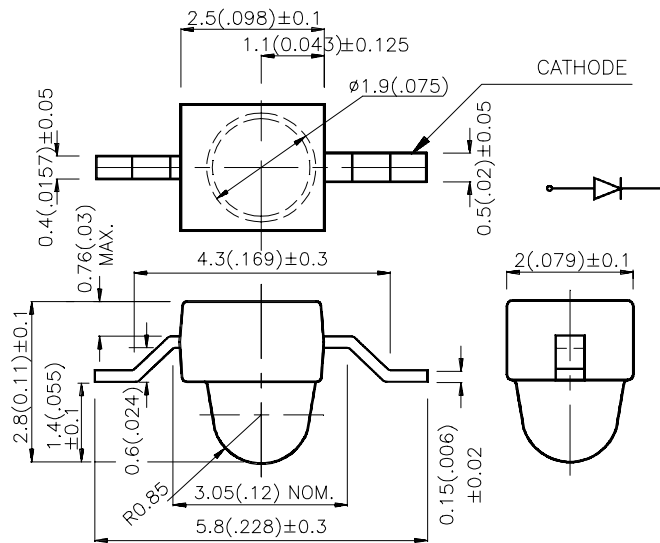

#### Notes:

1. All dimensions are in millimeters (inches).
2. Tolerance is ±0.25(0.01") unless otherwise noted.
3. Lead spacing is measured where the lead emerge package.
4. Specifications are subject to change without notice.

## Selection Guide

Part No.	Dice	Lens Type	Iv (mcd) @ 20 mA		Viewing Angle
			Min.	Typ.	2θ1/2
AM2520MGC09	MEGA GREEN (InGaAlP)	WATER CLEAR	100	400	20°

Note:

1. θ1/2 is the angle from optical centerline where the luminous intensity is 1/2 the optical centerline value.

## Electrical / Optical Characteristics at T<sub>A</sub>=25°C

Symbol	Parameter	Device	Typ.	Max.	Units	Test Conditions
λ <sub>peak</sub>	Peak Wavelength	Mega Green	574		nm	IF=20mA
λ <sub>D</sub>	Dominate Wavelength	Mega Green	568		nm	IF=20mA
Δλ 1/2	Spectral Line Halfwidth	Mega Green	26		nm	IF=20mA
C	Capacitance	Mega Green	20		pF	VF=0V;f=1MHz
V <sub>F</sub>	Forward Voltage	Mega Green	2.1	2.5	V	IF=20mA
I <sub>r</sub>	Reverse Current	Mega Green		10	μA	VR = 5V

## Absolute Maximum Ratings at T<sub>A</sub>=25°C

Parameter	Mega Green	Units
Power dissipation	105	mW
DC Forward Current	30	mA
Peak Forward Current [1]	205	mA
Reverse Voltage	5	V
Operating/Storage Temperature	-40°C To +85°C	

Note:

1. 1/10 Duty Cycle, 0.1ms Pulse Width.

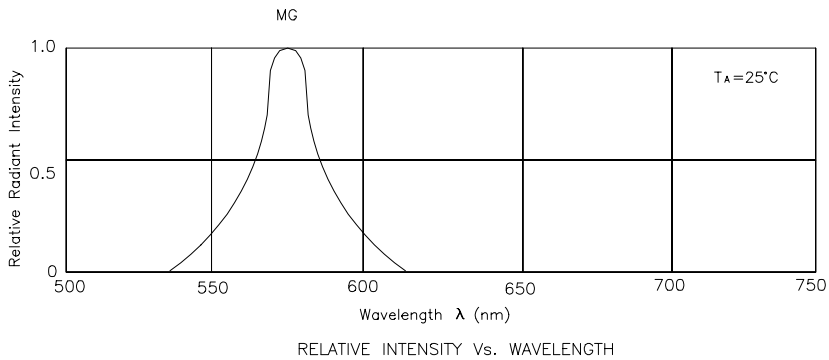

## Mega Green AM2520MGC09

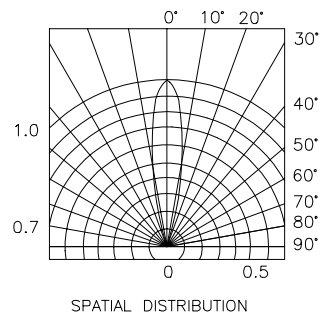
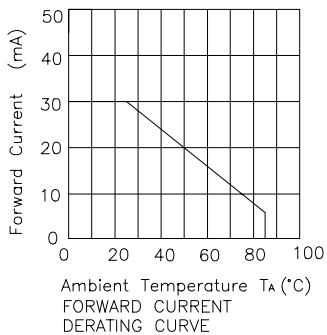
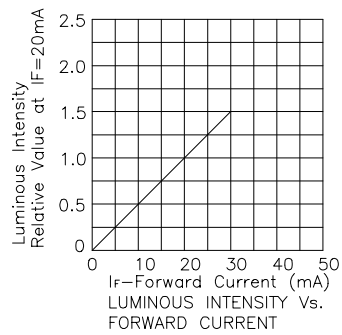
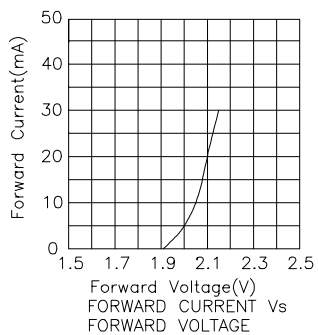

## AM2520MGC09 SMT Reflow Soldering Instructions

Number of reflow process shall be less than 2 times and cooling process to normal temperature is required between first and second soldering process.

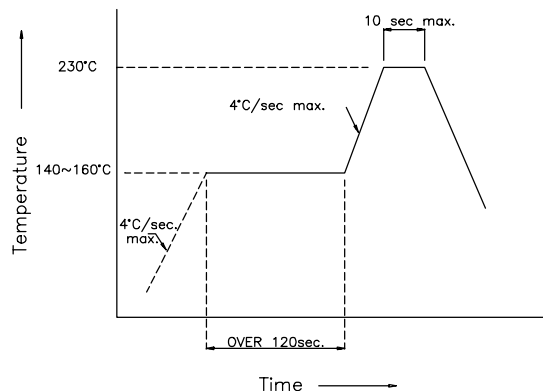

## Recommended Soldering Pattern (Units : mm)

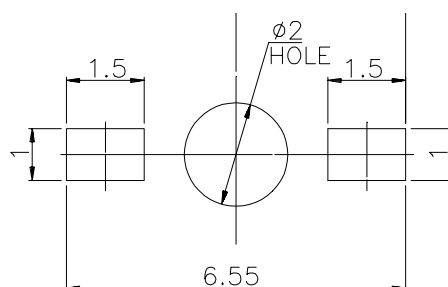

## Tape Specifications (Units : mm)

