

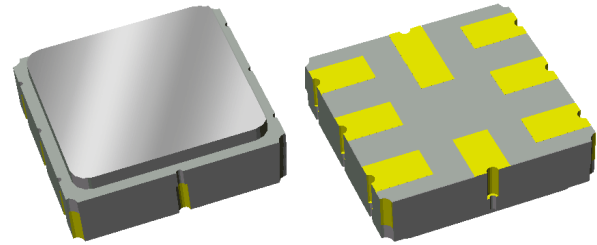

Applications

- For cable tuner applications



SMP-15, 3.8 x 3.8 x 1.27 mm

Product Features

- Usable bandwidth 10 MHz
- Low loss
- High attenuation
- Balanced operation
- Small size: 3.8 x 3.8 x 1.27 mm
- Ceramic Surface Mount Package (SMP)
- Hermetically sealed
- RoHS (2002/95/EC) compliant, Pb-free 

Functional Block Diagram

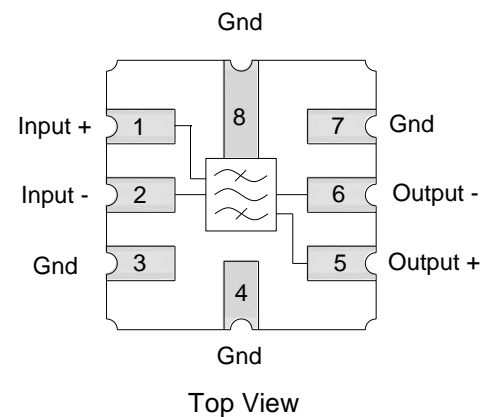

General Description

The 856096 is a high-performance IF SAW filter with a center frequency of 1090 MHz and a usable bandwidth of 10 MHz

It features low loss with excellent attenuation, and is designed to be used with a balanced input and output.

Pin Configuration

Pin No.	Label
1	Input +
2	Input -
5	Output +
6	Output -
3,4,7,8	Ground

Ordering Information

Part No.	Description
856096	Packaged Part
856096-EVB	Evaluation board

Standard T/R size = 4000 units/reel

Absolute Maximum Ratings

Parameter	Rating
Storage Temperature ⁽¹⁾	- 40 to + 85 °C
Operable Temperature ⁽²⁾	- 40 to + 85 °C

1. Operation of this device outside the parameter ranges given may cause permanent damage.
2. Specifications are not guaranteed over all operable conditions.

Electrical Specifications ⁽¹⁾

Test conditions unless otherwise noted: ⁽²⁾ Temperature Range - 40 to + 85 °C

Parameter ⁽³⁾	Conditions	Min	Typical ⁽⁴⁾	Max	Units
Center Frequency		-	1090	-	MHz
Maximum Insertion Loss ⁽⁵⁾	1085 – 1095 MHz	-	5.6	6.3	dB
Lower 1.25 dB Band Edge ⁽⁶⁾		-	1075	1085	MHz
Upper 1.25 dB Band Edge ⁽⁶⁾		1095	1103	-	
Amplitude Variation ⁽⁸⁾	1085 – 1095 MHz	-	0.3	1.25	dB p-p
Group Delay Ripple ⁽⁸⁾	1085 – 1095 MHz	-	4.5	20	ns p-p
Absolute Attenuation ⁽⁷⁾	500 – 1006 MHz	55	62	-	dB
	1006 – 1050 MHz	50	52	-	
	1140 – 1160 MHz	50	62	-	
	1160 – 1600	55	58	-	
Source/Load Impedance ⁽⁹⁾	Balanced	-	50	-	Ω

Notes:

1. All specifications are based on the TriQuint schematic reference design shown on page 3.
2. In production, devices will be tested at room temperature to a guard-banded specification to ensure electrical compliance over temperature.
3. Electrical margin has been built into the design to account for the variations due to temperature drift and manufacturing tolerances.
4. Typical values are based on average measurements at room temperature.
5. Referenced to maximum loss within the specified frequency points.
6. Relative to insertion loss at center frequency.
7. Absolute attenuation measurements are referenced to zero dB.
8. Total variation over the defined frequency range.
9. This is the optimum impedance in order to achieve the performance shown

Evaluation Board

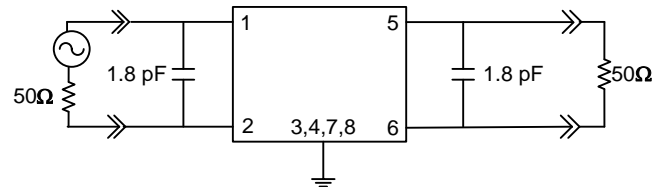
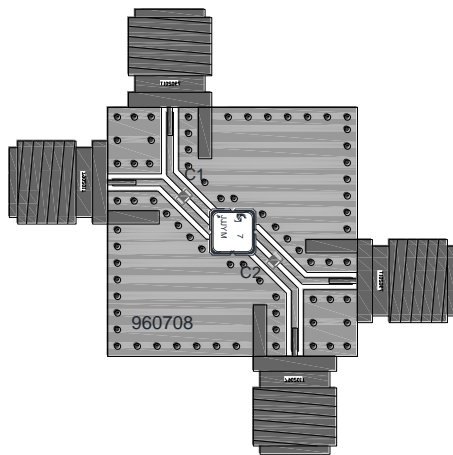

Notes:
 3-layers board - top, middle & bottom layer: 1 oz copper
 Substrates: .031" thick FR4 dielectric.
 Finish plating: Nickel: 3-8 μm thick, Gold: .03-.2 μm thick
 Hole plating: Copper min .0008 μm thick

PCB Mounting Pattern

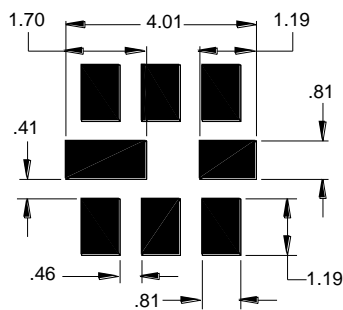

Notes:
 1. All dimensions are in millimeters. Angles are in degrees.
 2. This drawing specifies the mounting pattern used on the TriQuint evaluation board for this product. Some modification may be necessary to suit end user assembly materials and processes.

Bill of Material

Reference Des.	Value	Description	Manuf.	Part Number
C1	1.8 pF	Ceramic chip, 0402, ± 0.25 pF	Murata	GRM1555C1H1R8GZ01
C2	1.8 pF	Ceramic chip, 0402, ± 0.25 pF	Murata	GRM1555C1H1R8GZ01
SMA	N/A	SMA connector	Johnson Components	142-0701-801
PCB	N/A	3-layer	Multiple	960708

Performance Plots (Test conditions unless otherwise noted: Temp.= +25 °C)

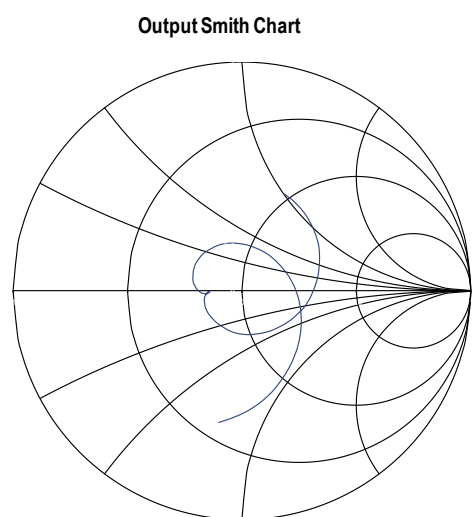
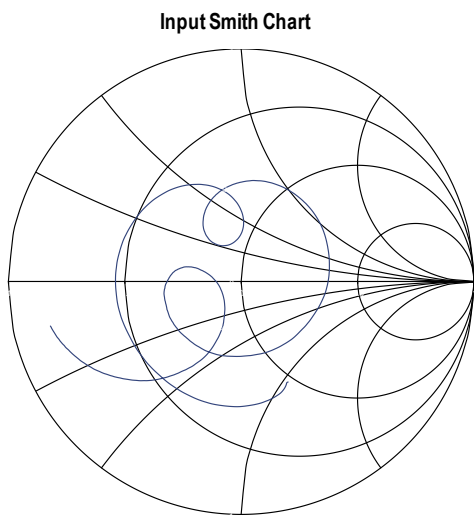
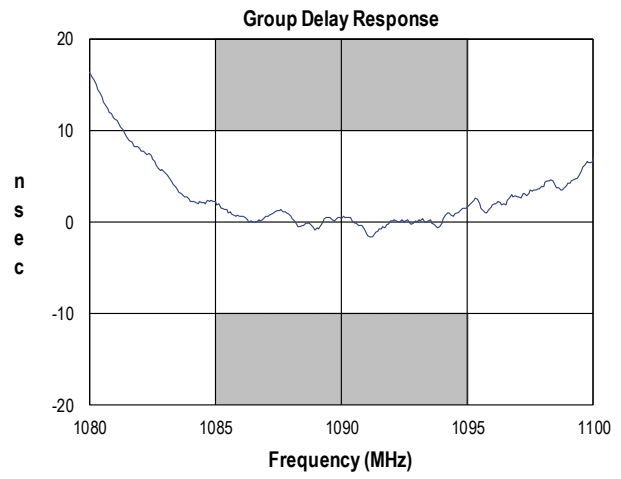
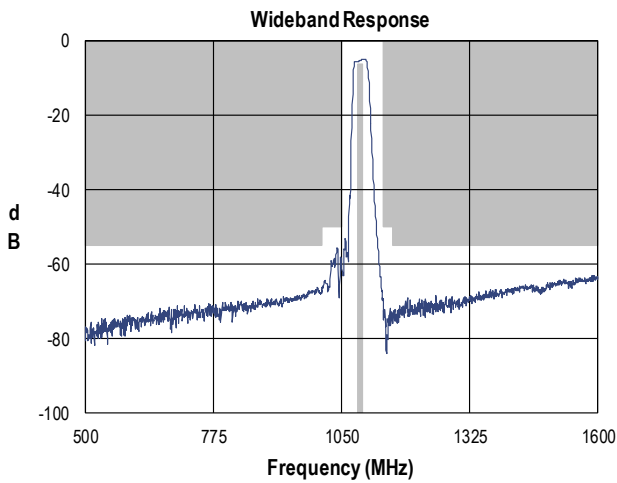
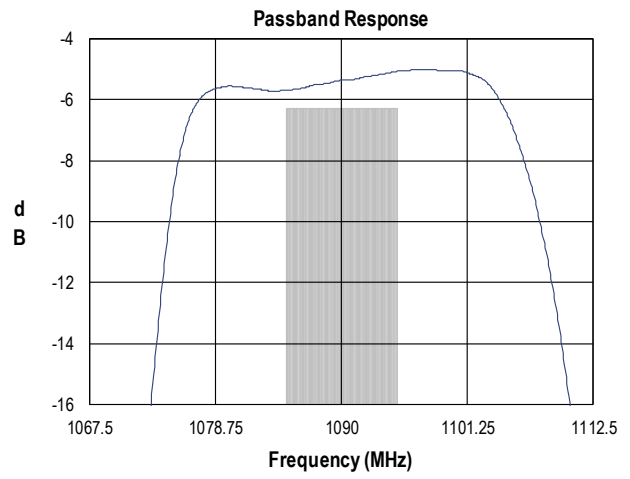
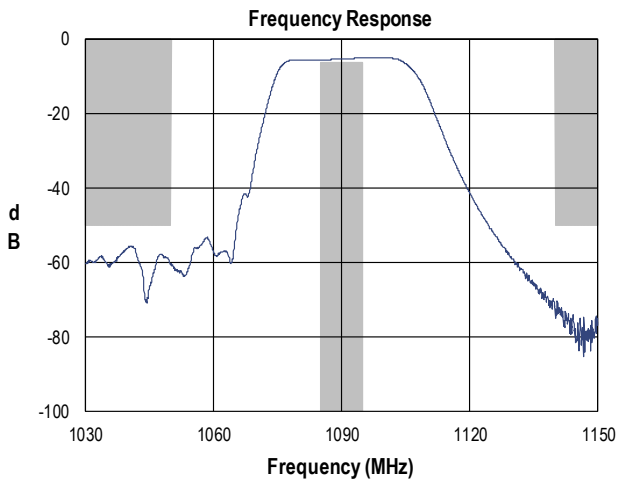

Mechanical Information

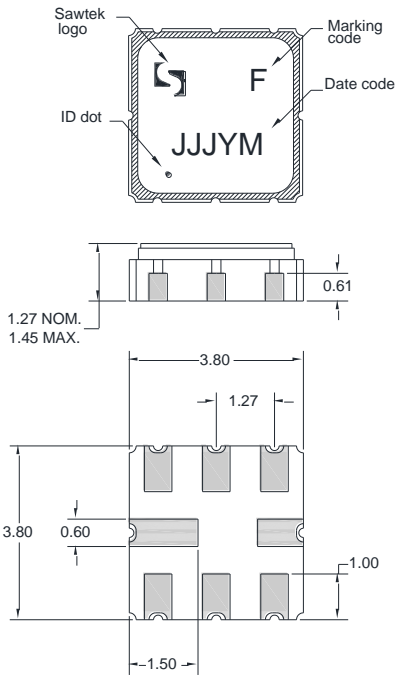

Package Style: SMP-15
Dimensions: 3.8 x 3.8 x 1.27 mm

Body: Al_2O_3 ceramic
Lid: Kovar, Ni plated
Terminations: Au plating 0.5 - 1.0 μ m, over a 2-6 μ m Ni plating

All dimensions shown are nominal in millimeters
All tolerances are ± 0.15 mm except overall length and width ± 0.10 mm

The date code consists of: day of the current year (Julian, 3 digits), Y = last digit of the year, and M = manufacturing site code

Notes:

1. All dimensions shown are typical in millimeters
2. An asterisk (*) in front of the marking code indicates prototype.

Tape and Reel information

Standard T/R size = 4000 units / reel. All dimensions are in millimeters

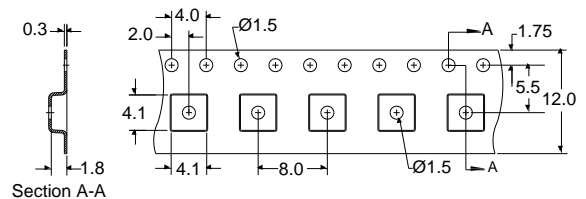
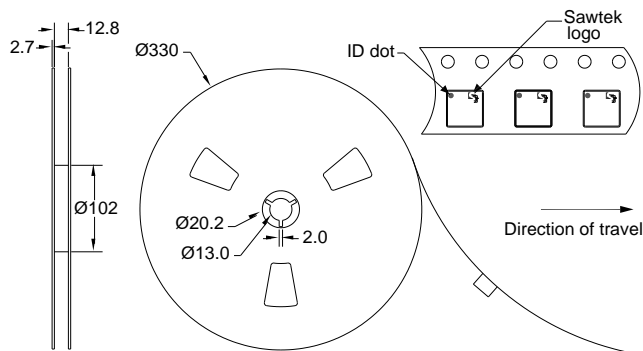

Product Compliance Information

ESD Sensitivity Ratings



Caution! ESD-Sensitive Device

ESD Rating: 0

Value: Passes ≥ 200 V min.
Test: Human Body Model (HBM)
Standard: ESDA/JEDEC JS-001-2012

ESD Rating: A

Value: Passes ≥ 100 V min.
Test: Machine Model (MM)
Standard: JEDEC Standard JESD22-A115

MSL Rating

Not applicable. Hermetic package.

Solderability

Compatible with both lead-free (260 °C maximum reflow temperature) and tin/lead (245 °C maximum reflow temperature) soldering processes.

Refer to [Soldering Profile](#) for recommended guidelines.

RoHS Compliance

This part is compliant with EU 2002/95/EC RoHS directive (Restrictions on the Use of Certain Hazardous Substances in Electrical and Electronic Equipment).

This product also has the following attributes:

- Lead Free
- Halogen Free (Chlorine, Bromine)
- Antimony Free
- TBBP-A (C₁₅H₁₂Br₄O₂) Free
- PFOS Free
- SVHC Free

Contact Information

For the latest specifications, additional product information, worldwide sales and distribution locations, and information about TriQuint:

Web: www.triquint.com
Email: info-sales@tqs.com

Tel: +1.407.886.8860
Fax: +1.407.886.7061

For technical questions and application information:

Email: flapplication.engineering@tqs.com

Important Notice

The information contained herein is believed to be reliable. TriQuint makes no warranties regarding the information contained herein. TriQuint assumes no responsibility or liability whatsoever for any of the information contained herein. TriQuint assumes no responsibility or liability whatsoever for the use of the information contained herein. The information contained herein is provided "AS IS, WHERE IS" and with all faults, and the entire risk associated with such information is entirely with the user. All information contained herein is subject to change without notice. Customers should obtain and verify the latest relevant information before placing orders for TriQuint products. The information contained herein or any use of such information does not grant, explicitly or implicitly, to any party any patent rights, licenses, or any other intellectual property rights, whether with regard to such information itself or anything described by such information.

TriQuint products are not warranted or authorized for use as critical components in medical, life-saving, or life-sustaining applications, or other applications where a failure would reasonably be expected to cause severe personal injury or death.