

SBA520AF SERIES

EXTREME LOW VF SCHOTTKY BARRIER RECTIFIER

Voltage	20~40 V	Current	5 A
----------------	----------------	----------------	------------

Features

- Ultra low forward voltage drop, low power loss
- Fast switching speed
- Surface mount package
- Ultra thin profile package for space constrained utilization
- Lead free in compliance with EU RoHS 2011/65/EU directive
- Green molding compound as per IEC61249 Std. . (Halogen Free)

Applications

- Low voltage rectification
- Reverse polarity protection
- Low power consumption applications

Mechanical Data

- Case: Molded plastic, SMAF
- Terminals: Solderable per MIL-STD-750, Method 2026
- Approx. Weight: 0.0012 ounces, 0.0328 grams

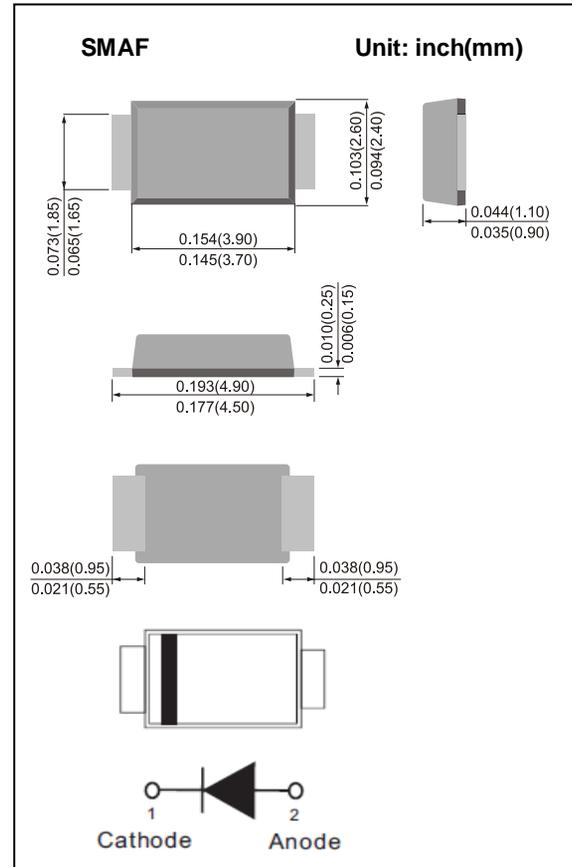

Maximum Ratings And Electrical Characteristics ($T_A=25^{\circ}\text{C}$ unless otherwise noted)

PARAMETER	SYMBOL	SBA520AF	SBA530AF	SBA540AF	UNIT
Maximum repetitive peak reverse voltage	V_{RRM}	20	30	40	V
Maximum rms voltage	V_{RMS}	14	21	28	V
Maximum dc blocking voltage	V_R	20	30	40	V
Maximum average forward rectified current	$I_{F(AV)}$	5			A
Peak forward surge current : 8.3ms single half sine-wave superimposed on rated load	I_{FSM}	80			A
Typical forward voltage at 10mA	V_F	0.17	0.17	0.17	V
Typical forward voltage at 1A	V_F	0.31	0.31	0.32	V
Typical forward voltage at 2A	V_F	0.34	0.35	0.36	V
Maximum forward voltage at 5A	V_F	0.45	0.46	0.49	V
Maximum dc reverse current at $T_J=25^{\circ}\text{C}$	I_R	300	300	250	μA
Typical thermal resistance	(Note 1)	$R_{\theta JC}$	15		$^{\circ}\text{C/W}$
	(Note 2)	$R_{\theta JA}$	150		
Operating junction temperature range	T_J	-55 to +150			$^{\circ}\text{C}$
Storage temperature range	T_{STG}	-55 to +150			$^{\circ}\text{C}$

- Note : 1. Mounted on a FR4 PCB, single-sided copper, with 100cm² copper pad area.
2. Mounted on a FR4 PCB, single-sided copper, mini pad.



SBA520AF SERIES

TYPICAL CHARACTERISTIC CURVES

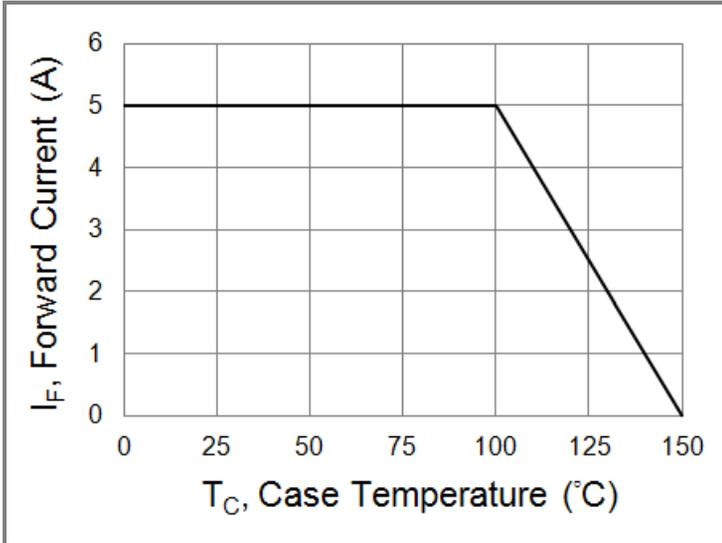

Fig.1 Forward Current Derating Curve

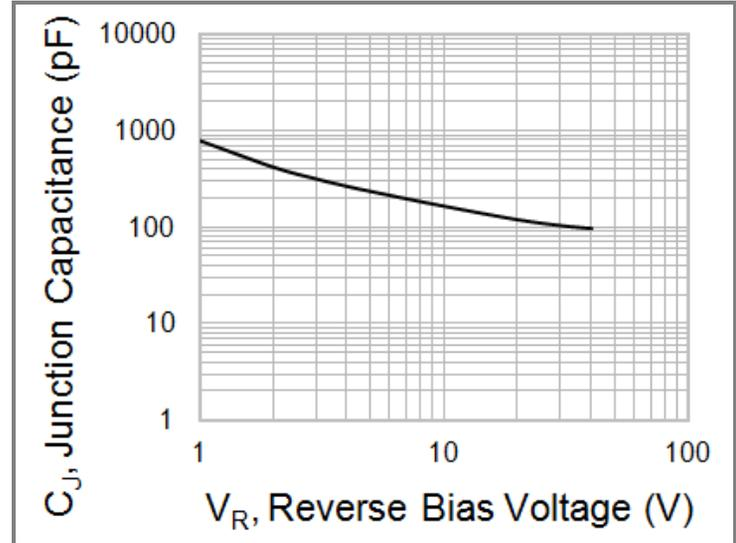

Fig. 2 Typical Junction Capacitance

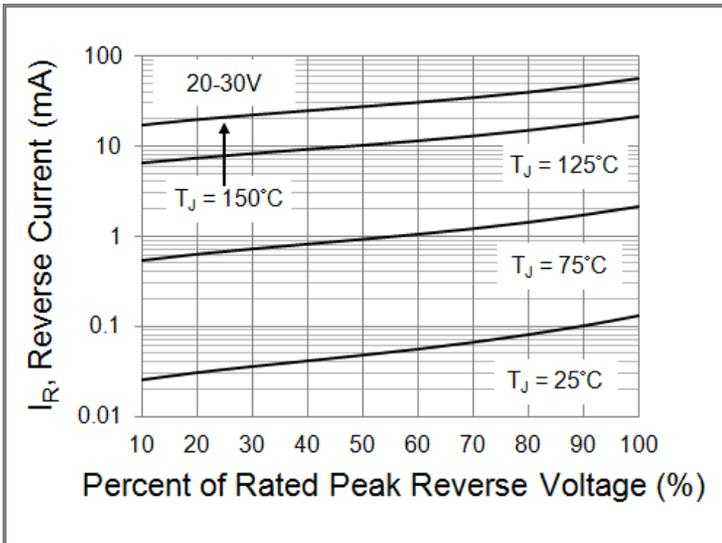

Fig.3 Typical Reverse Characteristics

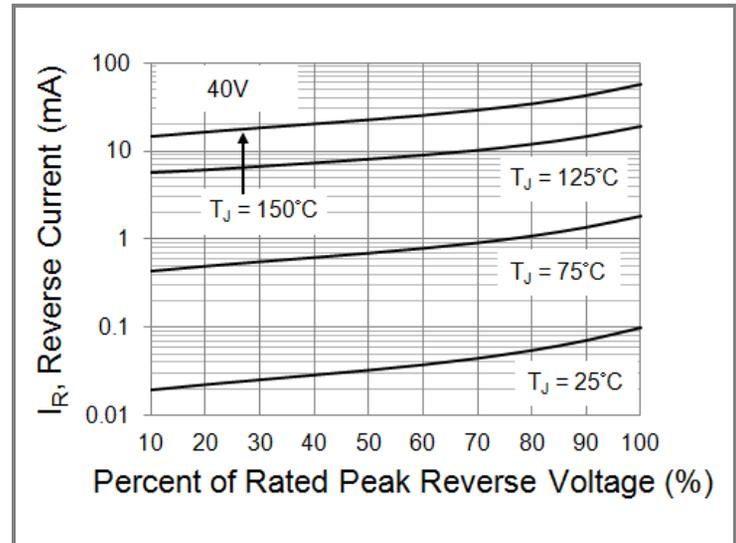

Fig.4 Typical Reverse Characteristics

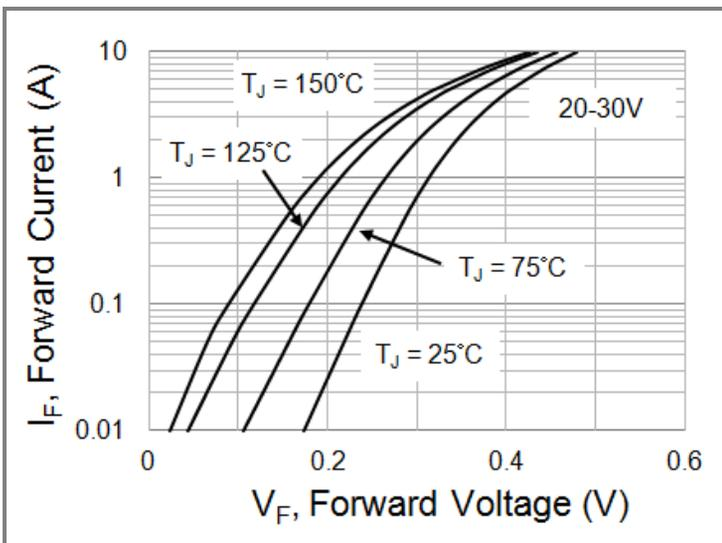

Fig.5 Typical Forward Characteristics

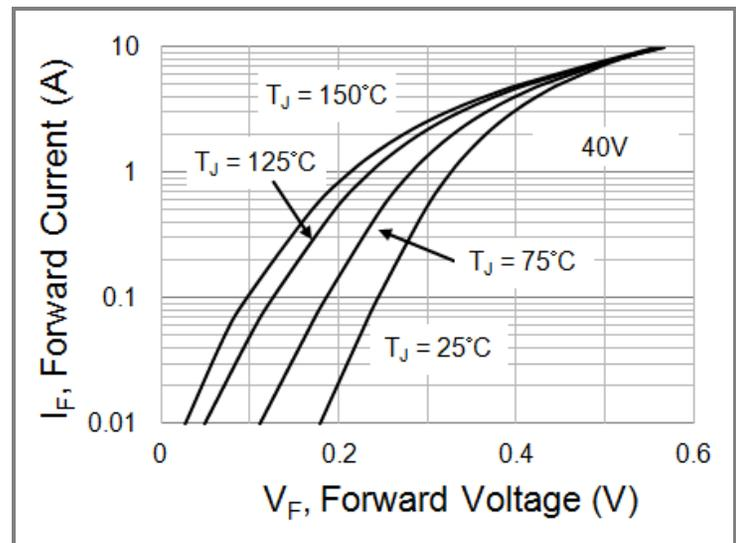
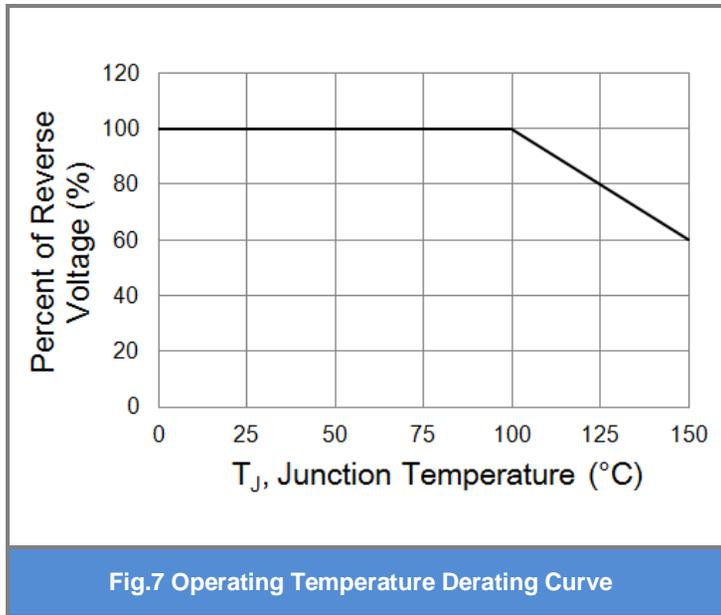

Fig.6 Typical Forward Characteristics



SBA520AF SERIES





SBA520AF SERIES

Part No Packing Code Version

Part No Packing Code	Package Type	Packing Type	Marking	Version
SBA520AF_R1_00001	SMAF	3K pcs / 7" reel	SBA520AF	Halogen free
SBA520AF_R2_00001	SMAF	10K pcs / 13" reel	SBA520AF	Halogen free
SBA530AF_R1_00001	SMAF	3K pcs / 7" reel	SBA530AF	Halogen free
SBA530AF_R2_00001	SMAF	10K pcs / 13" reel	SBA530AF	Halogen free
SBA540AF_R1_00001	SMAF	3K pcs / 7" reel	SBA540AF	Halogen free
SBA540AF_R2_00001	SMAF	10K pcs / 13" reel	SBA540AF	Halogen free

Mounting Pad Layout

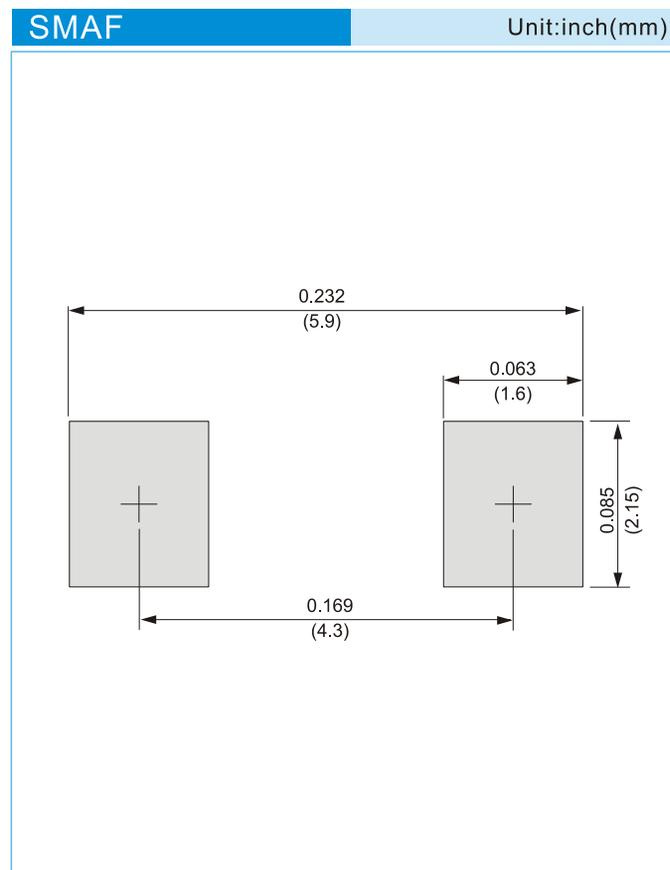



SBA520AF SERIES

Disclaimer

- Reproducing and modifying information of the document is prohibited without permission from Panjit International Inc..
- Panjit International Inc. reserves the rights to make changes of the content herein the document anytime without notification. Please refer to our website for the latest document.
- Panjit International Inc. disclaims any and all liability arising out of the application or use of any product including damages incidentally and consequentially occurred.
- Panjit International Inc. does not assume any and all implied warranties, including warranties of fitness for particular purpose, non-infringement and merchantability.
- Applications shown on the herein document are examples of standard use and operation. Customers are responsible in comprehending the suitable use in particular applications. Panjit International Inc. makes no representation or warranty that such applications will be suitable for the specified use without further testing or modification.
- The products shown herein are not designed and authorized for equipments requiring high level of reliability or relating to human life and for any applications concerning life-saving or life-sustaining, such as medical instruments, transportation equipment, aerospace machinery et cetera. Customers using or selling these products for use in such applications do so at their own risk and agree to fully indemnify Panjit International Inc. for any damages resulting from such improper use or sale.
- Since Panjit uses lot number as the tracking base, please provide the lot number for tracking when complaining.