

Product Summary

V_{RRM} (V)	I_o (A)	V_F (MAX) (V) @ +25°C	I_R (MAX) (mA) @ +25°C
100	2x15	0.8	0.045

Description

High voltage dual Schottky rectifier suited for switch mode power supplies and other power converters. This device is intended for use in medium voltage operation, and particularly, in high frequency circuits where low switching losses and low noise are required.

MBR30H100C is available in TO-220-3 (2) and TO-220F-3 (Option 1) packages.

Applications

- Power Supply Output Rectification
- Power Management
- Instrumentation



TO-220F-3 (Option 1)



TO-220-3 (2)

- Notes:
1. EU Directive 2002/95/EC (RoHS) & 2011/65/EU (RoHS 2) compliant. All applicable RoHS exemptions applied.
 2. See http://www.diodes.com/quality/lead_free.html for more information about Diodes Incorporated's definitions of Halogen- and Antimony-free, "Green" and Lead-free.
 3. Halogen- and Antimony-free "Green" products are defined as those which contain <900ppm bromine, <900ppm chlorine (<1500ppm total Br + Cl) and <1000ppm antimony compounds.

Features

- Low Forward Voltage: 0.8V @ +25°C
- High Surge Current Capacity
- +175°C Operating Junction Temperature
- 30A Total (15A Each Diode Leg)
- Guard-Ring for Stress Protection
- Pb-free Package
- TO-220-3 (2) and TO-220F-3 (Option 1)
 - **Lead-Free Finish; RoHS Compliant (Notes 1 & 2)**
- Available in "Green" Packages: TO-220-3 (2) and TO-220F-3 (Option 1)
 - **Lead-Free Finish; RoHS Compliant (Notes 1 & 2)**
 - **Halogen and Antimony Free. "Green" Device (Note 3)**

Mechanical Data

- Case: TO-220-3 (2), TO-220F-3 (Option 1)
- Case Material: Molded Plastic, "Green" Molding Compound. UL Flammability Classification Rating 94V-0
- Moisture Sensitivity: Level 1 per J-STD-020
- Terminals: Finish - Matte Tin annealed over Copper Leadframe. Solderable per MIL-STD-202, Method 208 ^(E3)
- Polarity: See Below
- Weight:
 - TO-220-3 (2) – 1.95 Grams (Approximate)
 - TO-220F-3 (Option 1) – 1.69 Grams (Approximate)

Pin Assignments

(Front View)

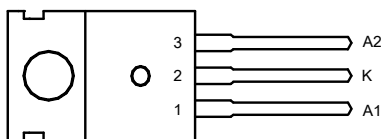

TO-220-3 (2)

(Front View)

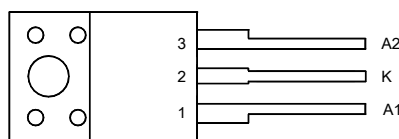

TO-220F-3 (Option 1)

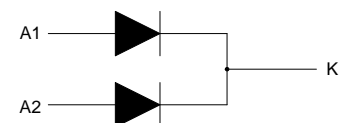

Internal Structure of MBR30H100C

Ordering Information (Note 4)

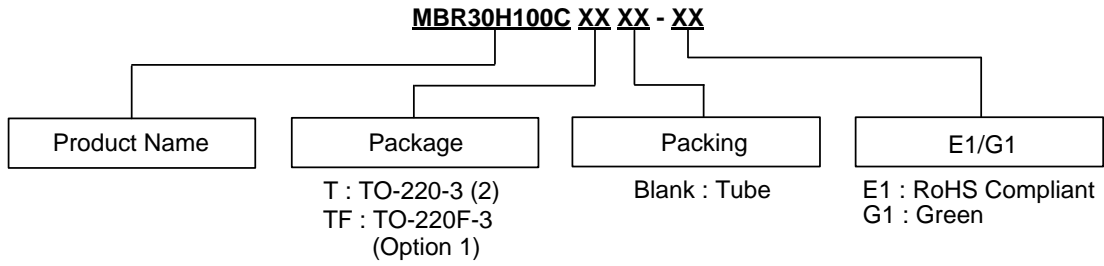

Note 4: Diodes IC's Pb-free products, as designated with "E1" suffix in the part number, are RoHS compliant. Products with "G1" suffix are available in green packages.



Package	Part Number	Marking ID	Packing
TO-220-3 (2)	MBR30H100CT-E1	MBR30H100CT-E1	50 Pieces/Tube
TO-220-3 (2)	MBR30H100CT-G1	MBR30H100CT-G1	50 Pieces/Tube
TO-220F-3 (Option 1)	MBR30H100CTF-E1	MBR30H100CTF-E1	50 Pieces/Tube
TO-220F-3 (Option 1)	MBR30H100CTF-G1	MBR30H100CTF-G1	50 Pieces/Tube

Marking Information

(1) TO-220-3 (2)

(Front View)

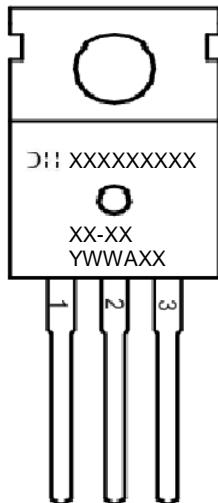

First and Second Lines: Logo and Marking ID
(See Ordering Information)
Third Line: Date Code
Y: Year
WW: Work Week of Molding
A: Assembly House Code
XX: 7th and 8th Digits of Batch Number

Marking Information (Cont.)

(2) TO-220F-3 (Option 1)

(Front View)

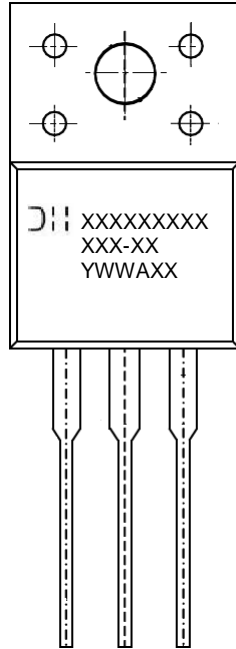

First and Second Lines: Logo and Marking ID
 (See Ordering Information)
 Third Line: Date Code
 Y: Year
 WW: Work Week of Molding
 A: Assembly House Code
 XX: 7th and 8th Digits of Batch Number

Maximum Ratings (Each Diode Leg) (Note 5)

Characteristic	Symbol	Rating	Unit
Peak Repetitive Reverse Voltage	V_{RRM}		
Working Peak Reverse Voltage	V_{RWM}	100	V
DC Blocking Voltage	V_R		
Average Rectified Forward Current (Rated V_R) $T_C = +162^\circ\text{C}$	$I_{F(AV)}$	15	A
Peak Repetitive Forward Current (Rated V_R , Square Wave, 20kHz) $T_C = +150^\circ\text{C}$	I_{FRM}	30	A
Non Repetitive Peak Surge Current (Surge Applied at Rated Load Conditions Half Wave, Single Phase, 60Hz)	I_{FSM}	250	A
Operating Junction Temperature (Note 6)	T_J	+175	$^\circ\text{C}$
Storage Temperature Range	T_{STG}	-65 to +175	$^\circ\text{C}$
Voltage Rate of Change (Rated V_R)	dv/dt	10000	V/ μs
ESD (Machine Model = C)	–	>400	V
ESD (Human Body Model = 3B)	–	>8000	V

Notes: 5. Stresses greater than those listed under "Absolute Maximum Ratings" may cause permanent damage to the device. These are stress ratings only, and functional operation of the device at these or any other conditions beyond those indicated under "Recommended Operating Conditions" is not implied. Exposure to "Absolute Maximum Ratings" for extended periods may affect device reliability.

6. The heat generated must be less than the thermal conductivity from Junction to Ambient: $dP_D/dT_J < 1/\theta_{JA}$.

Thermal Characteristics

Characteristic	Symbol	Rating		Unit
Maximum Thermal Resistance (Junction to Case) (Note 7)	R θ_{JC}	TO-220-3 (2)	2.0	°C/W
		TO-220F-3 (Option 1)	2.5	
Maximum Thermal Resistance (Junction to Ambient) (Note 7)	R θ_{JA}	TO-220-3 (2)	60	°C/W

Note 7: Device mounted on heat sink, with minimum recommended pad layout per <http://www.diodes.com>

Electrical Characteristics (Each Diode Leg)

Characteristic	Symbol	Rating	Unit	Test Condition
Maximum Instantaneous Forward Voltage Drop (Note 8)	V _F	0.80	V	I _F = 15A, T _C = +25°C
		0.67		I _F = 15A, T _C = +125°C
		0.93		I _F = 30A, T _C = +25°C
		0.80		I _F = 30A, T _C = +125°C
Maximum Instantaneous Reverse Current (Note 8)	I _R	6.0	mA	Rated DC Voltage, T _C = +125°C
		0.0045		Rated DC Voltage, T _C = +25°C

Note 8: Short duration pulse test used to minimize self-heating effect, Pulse Test Width = 300 μ s, Duty Cycle \leq 2.0%.

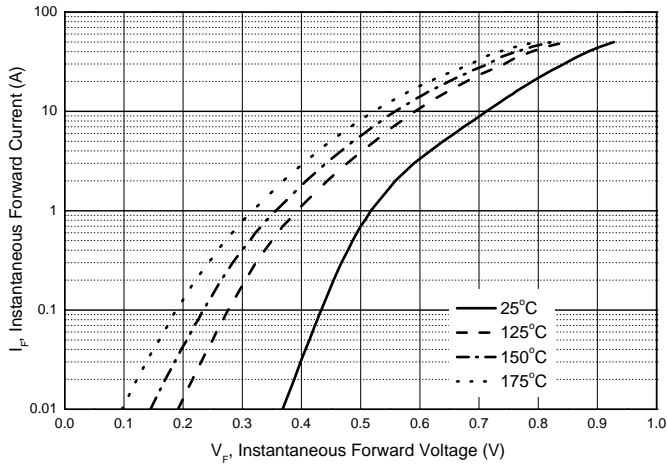

Figure 1. Typical Forward Voltage

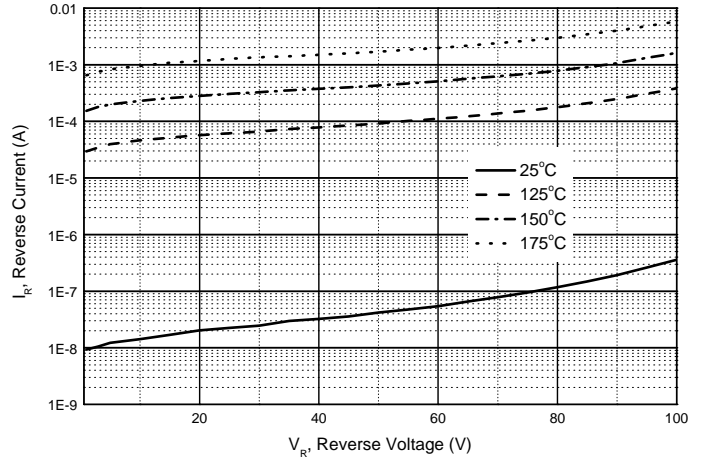

Figure 2. Typical Reverse Current

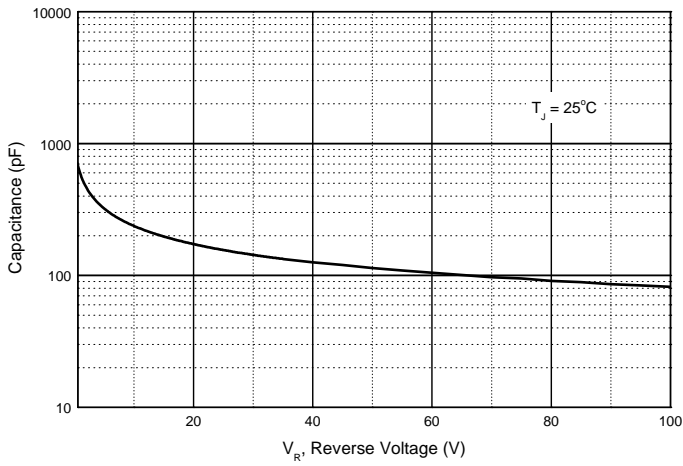

Figure 3. Capacitance vs. V_{R1} Reverse Voltage

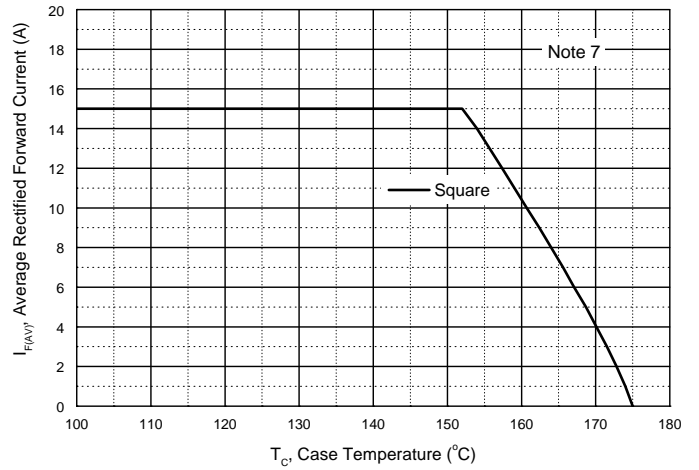
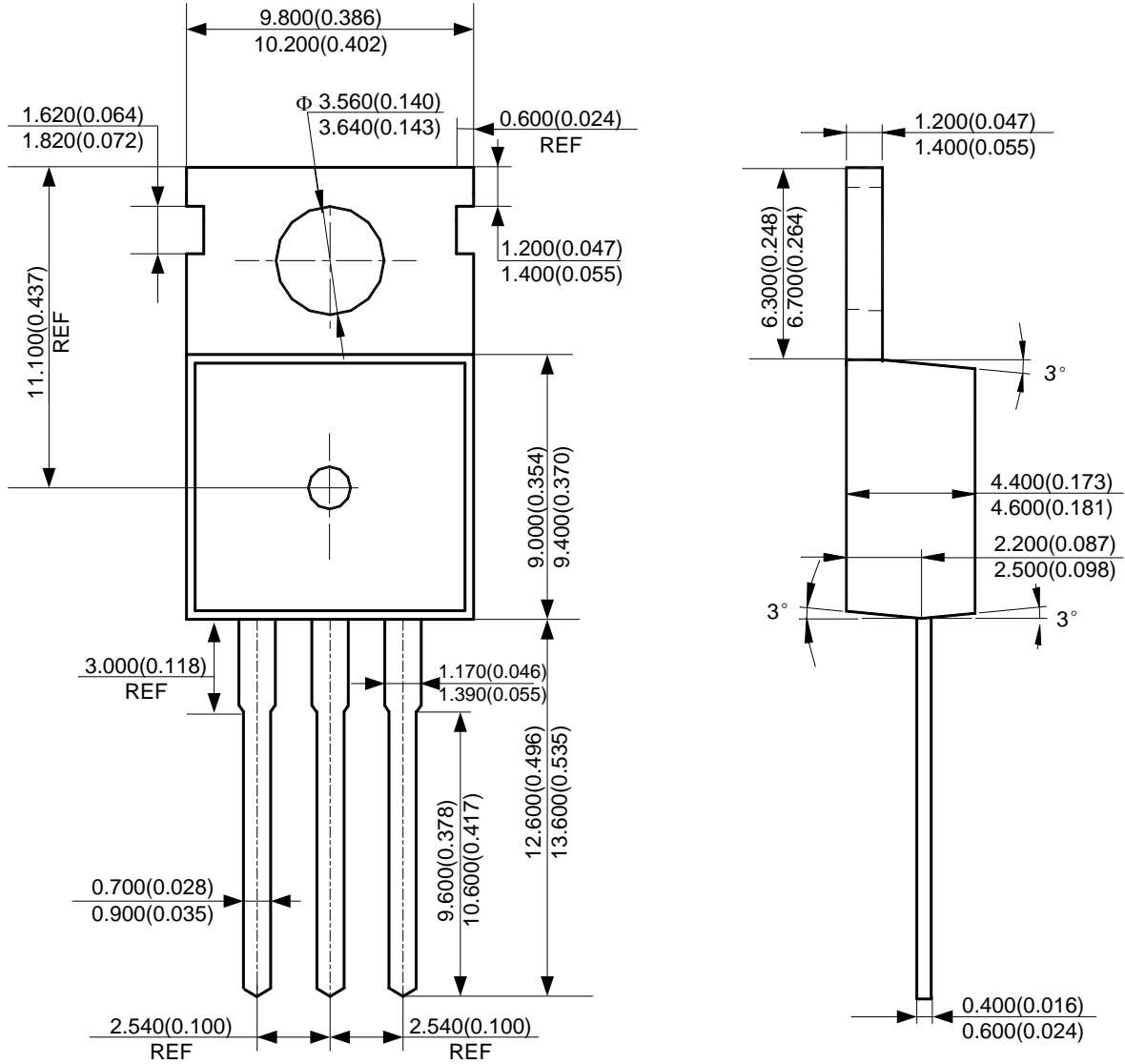

Figure 4. Average Rectified Forward Current vs. Case Temperature (Square, Each Diode)

Package Outline Dimensions (All dimensions in mm(inch).)

(1) Package Type: TO-220-3 (2)



Package Outline Dimensions (Cont. All dimensions in mm(inch).)

(2) Package Type: TO-220F-3

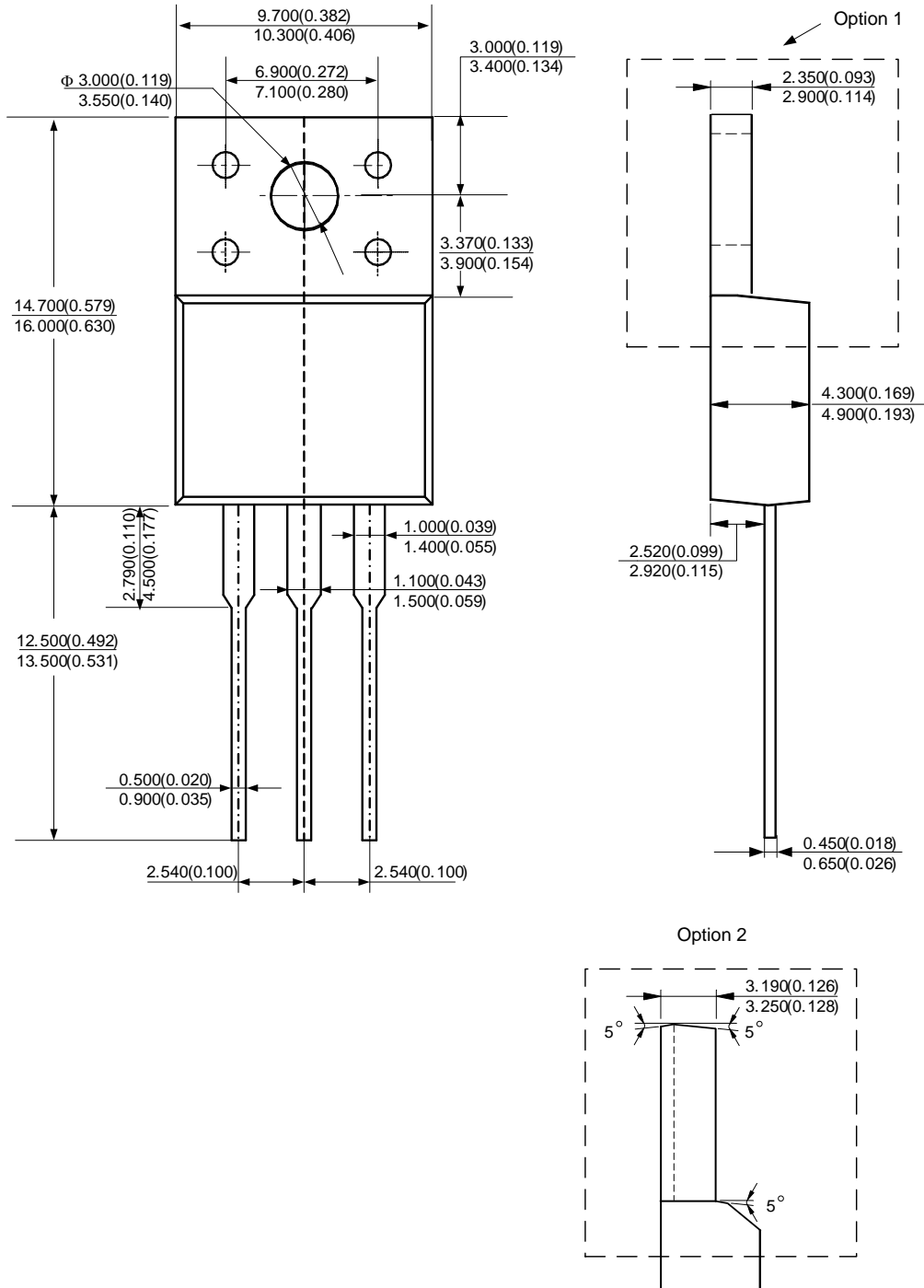

IMPORTANT NOTICE

DIODES INCORPORATED MAKES NO WARRANTY OF ANY KIND, EXPRESS OR IMPLIED, WITH REGARDS TO THIS DOCUMENT, INCLUDING, BUT NOT LIMITED TO, THE IMPLIED WARRANTIES OF MERCHANTABILITY AND FITNESS FOR A PARTICULAR PURPOSE (AND THEIR EQUIVALENTS UNDER THE LAWS OF ANY JURISDICTION).

Diodes Incorporated and its subsidiaries reserve the right to make modifications, enhancements, improvements, corrections or other changes without further notice to this document and any product described herein. Diodes Incorporated does not assume any liability arising out of the application or use of this document or any product described herein; neither does Diodes Incorporated convey any license under its patent or trademark rights, nor the rights of others. Any Customer or user of this document or products described herein in such applications shall assume all risks of such use and will agree to hold Diodes Incorporated and all the companies whose products are represented on Diodes Incorporated website, harmless against all damages.

Diodes Incorporated does not warrant or accept any liability whatsoever in respect of any products purchased through unauthorized sales channel. Should Customers purchase or use Diodes Incorporated products for any unintended or unauthorized application, Customers shall indemnify and hold Diodes Incorporated and its representatives harmless against all claims, damages, expenses, and attorney fees arising out of, directly or indirectly, any claim of personal injury or death associated with such unintended or unauthorized application.

Products described herein may be covered by one or more United States, international or foreign patents pending. Product names and markings noted herein may also be covered by one or more United States, international or foreign trademarks.

This document is written in English but may be translated into multiple languages for reference. Only the English version of this document is the final and determinative format released by Diodes Incorporated.

LIFE SUPPORT

Diodes Incorporated products are specifically not authorized for use as critical components in life support devices or systems without the express written approval of the Chief Executive Officer of Diodes Incorporated. As used herein:

A. Life support devices or systems are devices or systems which:

1. are intended to implant into the body, or
2. support or sustain life and whose failure to perform when properly used in accordance with instructions for use provided in the labeling can be reasonably expected to result in significant injury to the user.

B. A critical component is any component in a life support device or system whose failure to perform can be reasonably expected to cause the failure of the life support device or to affect its safety or effectiveness.

Customers represent that they have all necessary expertise in the safety and regulatory ramifications of their life support devices or systems, and acknowledge and agree that they are solely responsible for all legal, regulatory and safety-related requirements concerning their products and any use of Diodes Incorporated products in such safety-critical, life support devices or systems, notwithstanding any devices- or systems-related information or support that may be provided by Diodes Incorporated. Further, Customers must fully indemnify Diodes Incorporated and its representatives against any damages arising out of the use of Diodes Incorporated products in such safety-critical, life support devices or systems.

Copyright © 2014, Diodes Incorporated

www.diodes.com