

CG4 Series



Agency Approvals

AGENCY	AGENCY FILE NUMBER
	E320116

Two Electrode GDT Graphical Symbol

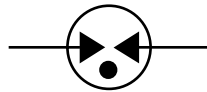

Description

Littelfuse CG4 Gas Discharge Tubes (GDT) series provides high levels of protection against fast rising transients caused by lightning disturbances. Offered in a miniature surface mount package, it has a surge rating of 3kA 8/20µs.

Littelfuse CG4 mini GDTs are high voltage (800-3000V) devices designed for surge protection and high isolation applications. It is also suitable for applications for which bias voltage or signal levels of several hundred volts are normally present.

This CG4 mini GDTs are also suitable for applications with bias voltages or signal levels of several hundred volts. It can be used in conjunction with Littelfuse MOV (Metal Oxide Varistor) to provide superior protection performance.

Features

- Voltage Ranges 800V to 3000V
- Excellent response to fast rising transients
- 3kA 8/20µs surge rating
- UL 1449 recognized
- Offered with two squared terminals
- Non-Radioactive
- Ultra Low capacitance (<0.8pF)
- RoHS compliant and Lead-free

Applications

- CATV equipment
- Antennas
- Air conditioning
- EV Power Station
- Inverters/Variable Frequency Drives (VFD)
- IEEE 803.2 compliant Ethernet interfaces
- Power Supplies
- Medical electronics
- Test Equipment
- Renewable Energy

Electrical Characteristics

Part Number	Device Specifications (at 25°C)						Life Ratings					
	DC Breakdown in Volts (@100V/s)			Impulse Break-down in Volts (@100V/μs)	Impulse Break-down In Volts (@1 kV/μs)	Insulation Resistance	Capacitance (@1MHz)	Max Impulse Discharge Current (8/20μs)	AC Discharge Current (50Hz, 1sec)	AC Discharge Current (Single, 9 Cycles)	Arc Voltage (On State Voltage @ 1Amp, 1Min)	Impulse Life (10/1000μs) (100A)
	MIN	TYP	MAX	MAX		MIN	MAX		MIN	MIN		MIN
CG40.8	640	800	960	1200	1300	1GΩ*	0.8pf	10 Shots @ (3kA) 1 Shot at 5kA	3A	10A	20V	300 Shots
CG41.0	800	1000	1200	1400	1500							
CG41.2	960	1200	1440	1600	1700							
CG41.8	1440	1800	2160	2400	2500							
CG42.0	1600	2000	2400	2600	2700							
CG42.5	2000	2500	3000	3000	3200							
CG42.7	2160	2700	3240	3200	3600							
CG43.0	2400	3000	3600	3500	3900							

Note:

* Insulation resistance measured at:

- 250Vdc for CG40.8,
- 500Vdc for CG41.0, CG41.2, CG41.8 and CG42.0,
- 1000Vdc for CG42.5, CG42.7 and CG43.0

Product Characteristics

Materials	Device Tin Plated 17.5 ± 12.5 Microns Construction: Ceramic Insulator
Storage and Operational Temperature	-40 to +90°C

Soldering Parameters - Reflow Soldering (Surface Mount Devices)

Reflow Condition	Pb – Free assembly	
Pre Heat	- Temperature Min ($T_{s(min)}$)	150°C
	- Temperature Max ($T_{s(max)}$)	200°C
	- Time (Min to Max) (t_s)	60 – 180 secs
Average ramp up rate (Liquidus Temp (T_L) to peak)		3°C/second max
$T_{s(max)}$ to T_L - Ramp-up Rate		5°C/second max
Reflow	- Temperature (T_L) (Liquidus)	217°C
	- Temperature (t_L)	60 – 150 seconds
Peak Temperature (T_p)		260 ^{+0/-5} °C
Time within 5°C of actual peak Temperature (t_p)		10 – 30 seconds
Ramp-down Rate		6°C/second max
Time 25°C to peak Temperature (T_p)		8 minutes Max.
Do not exceed		260°C

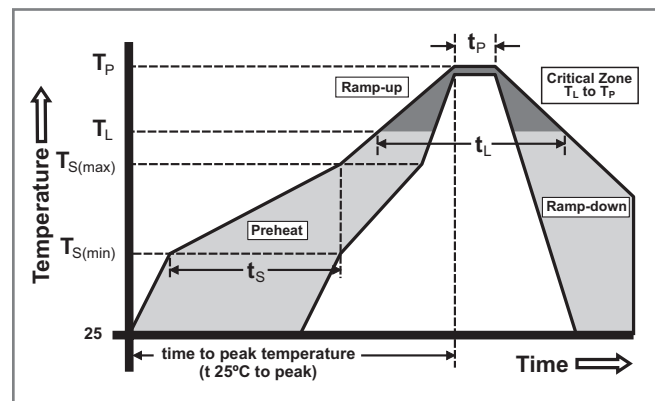

Device Dimensions

Dimensions in millimeters

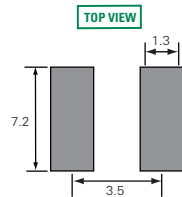
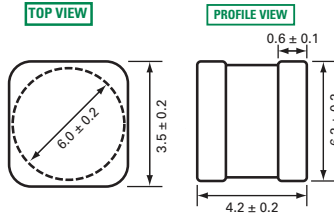

Recommended Soldering Pad Layout

Product Marking

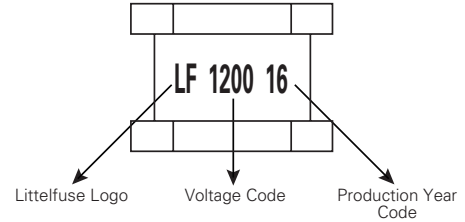

Part Numbering System and Ordering Information

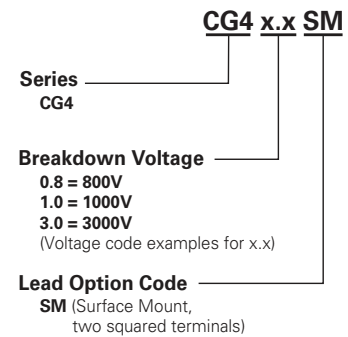

Taping and Reel Specifications

Unit = mm

Item	Spec	Item	Spec
P	8 ± 0.1	E	1.75 ± 0.1
P0	4.0 ± 0.1	D	Ø1.55 ± 0.05
W	16.0 ± 0.3	K	6.5 ± 0.1
F	7.5 ± 0.1	t	0.4 ± 0.05
A0	4.9 ± 0.1	B0	6.5 ± 0.1

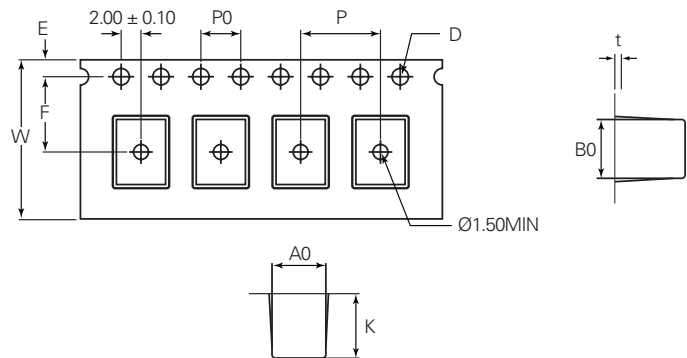

Packaging Quantity: 1000 pcs per reel (13")
 1 reels per inner box
 10 inners box per carton
 10,000 pcs per full carton

