



Specification

Model No. : FXP.400

Part No. : **FXP.400.07.0100A**

Product Name : High Efficiency Ultra Wide-Band Antenna with 100mm Ø1.13 cable IPEX MHF(U.FL)

Features : High efficiency and ultra wide band
Cover all LTE operation frequencies
100*38*0.1mm

International Patent #: US 2009/0189825 A1

RoHS ✓

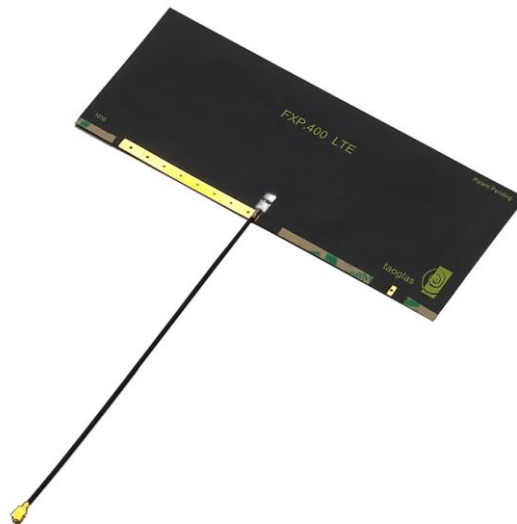

REVISION STATUS

Version	Date	Page	Revision Description	Prepared	Approved
01	23 September 2009	All	New release	Giuseppe RuvioAHFR	Dermot O'Shea
02	12 March 2010	All	Update 3D Chamber result	Zita Lin	Dermot O'Shea



1.0 Introduction

This flexible wideband ultra wide band antenna has been designed by using DIT Antenna High Frequency and Research Centre patented antenna design methodology in Dublin, Ireland. Taoglas and DIT have developed this range of solutions following years of expertise and collaboration in design of high performance ultra wide band antennas for wireless devices.

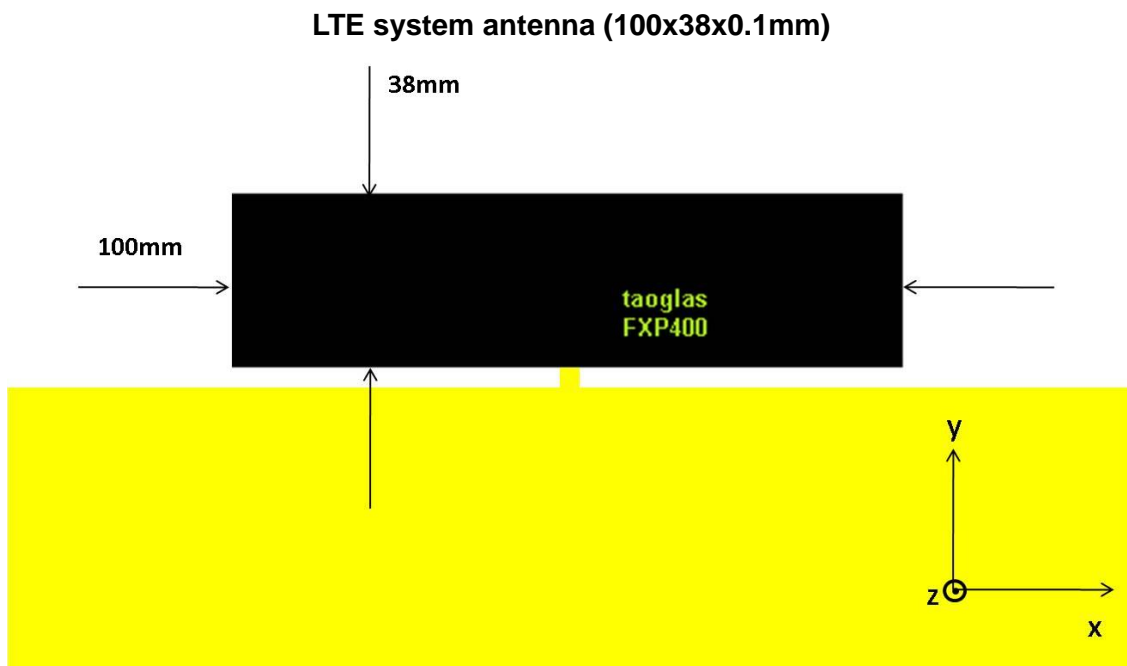

Taoglas have designed an ultra wideband antenna solution for global LTE “4G” systems. The bands are 690 MHz – 940 MHz and 1720 MHz – 3130 MHz.

The antenna is delivered on flexible circuit material which is ideal for the radiation patterns of antennas with higher frequencies and wider bandwidth. The efficiencies of the antenna are over 70% across the bands.

This material allows the antenna to be placed on the edge of a PCB and folded over the PCB or folded upwards and adhered to the device housing itself.

The antenna is currently available with cable and connector and its own ground plane for evaluation purposes.



Specification

2.0 Specification

ELECTRICAL	
Working Frequency	690~940MHz 1720~3130MHz
Gain	0.55~ 4dBi
Polarization	Linear
Impedance	50 ohms
Max Input Power	10 watts
VSWR	<2.0:1
MECHANICAL	
Dimensions	100 x 38 mm
Cable	Black 100mm 1.13 co-axial
Connector	IPEX MHF1
ENVIRONMENTAL	
Temperature Range	-40°C to +85°C
Humidity	Non-condensing 65°C 95% RH

* Actual Electrical value will depend on customer ground plane size



3.0 Antenna Response with Different Ground

The performance of the antenna remains quite stable on different ground plane lengths and widths as can be observed from the parametric sweeps of the ground plane length (*hgp*) and ground plane width (*wgp*).

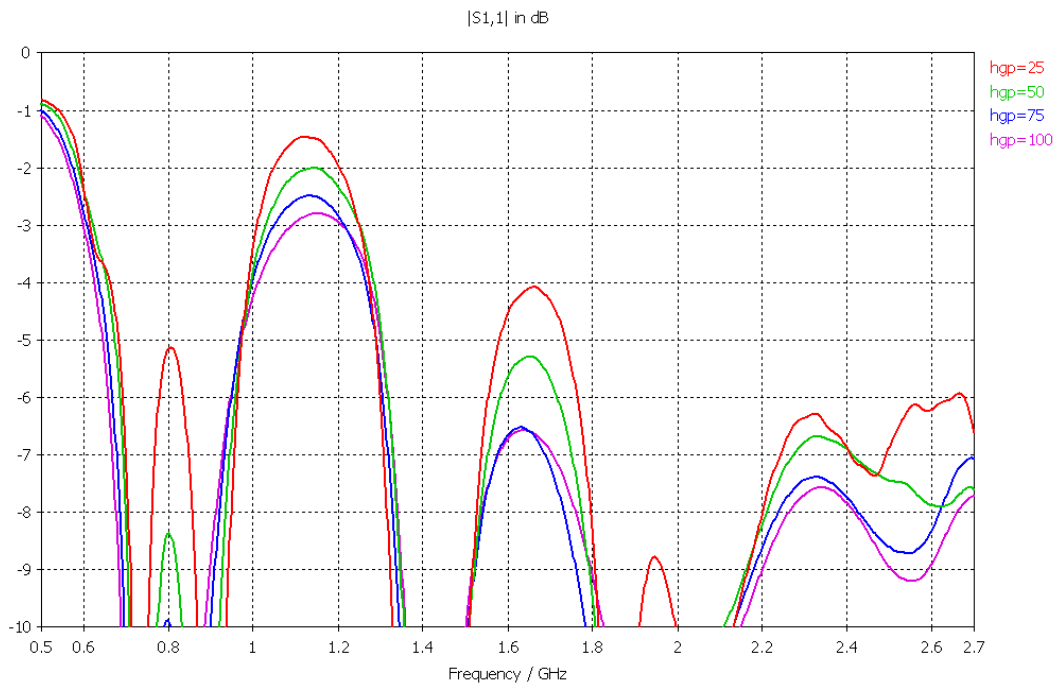
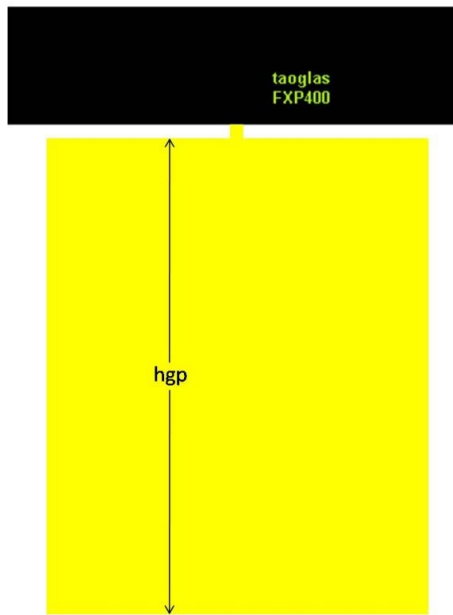

HGP = Ground plane length (mm)



Specification

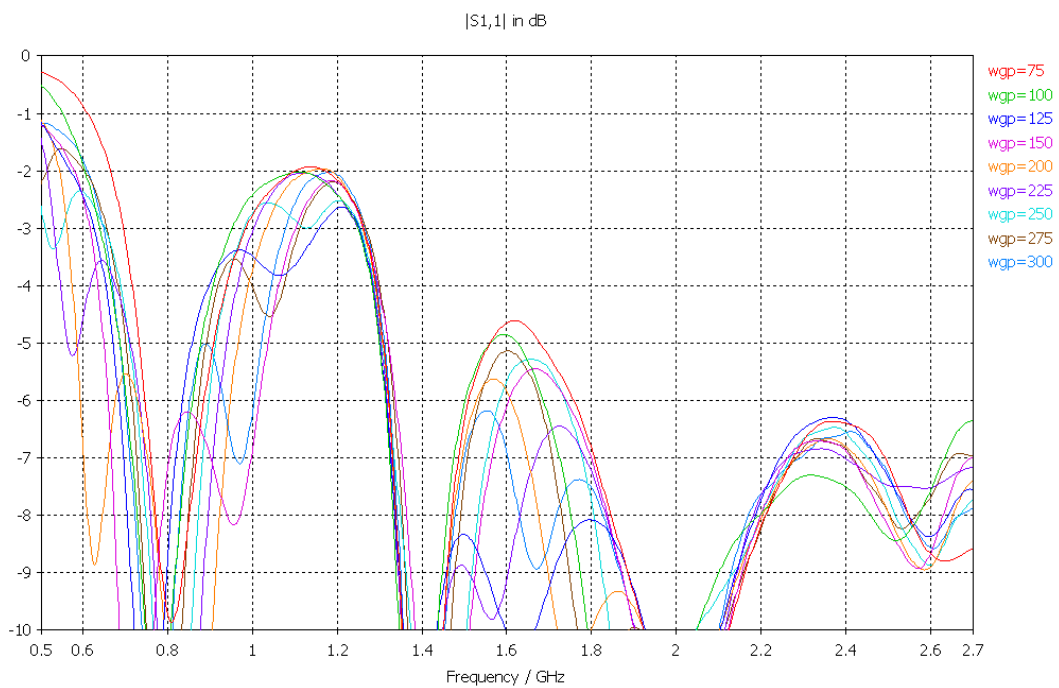
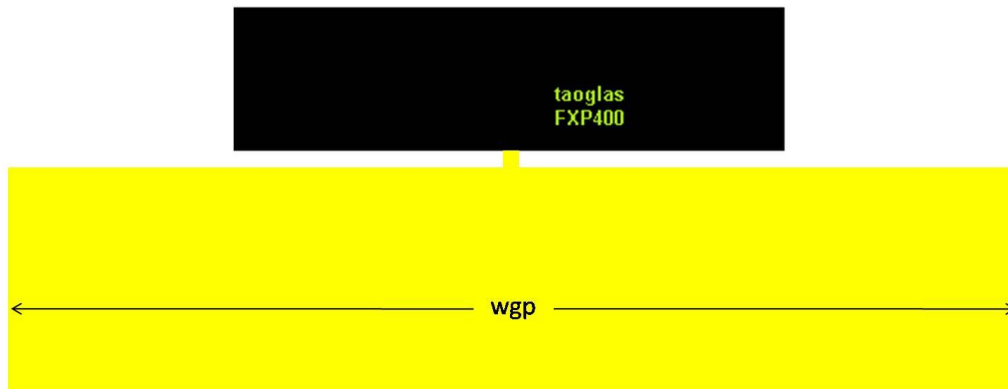

wgp = Ground plane width (mm)

The performance of the antenna remains quite stable on different points of a PCB as can be observed from parametric sweeps of the antenna at an offset location x on the ground plane.

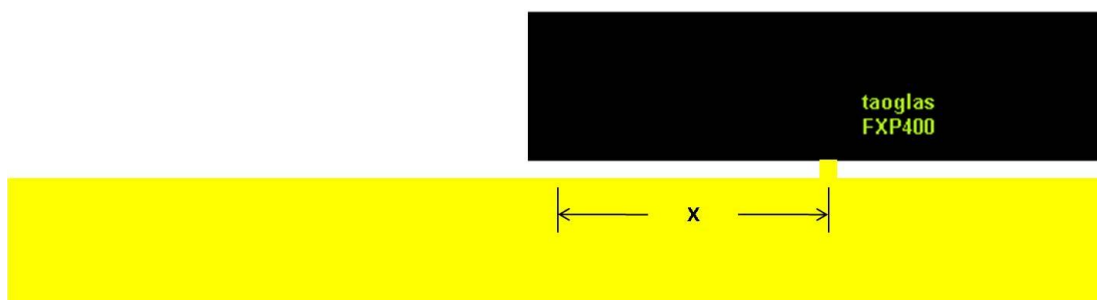

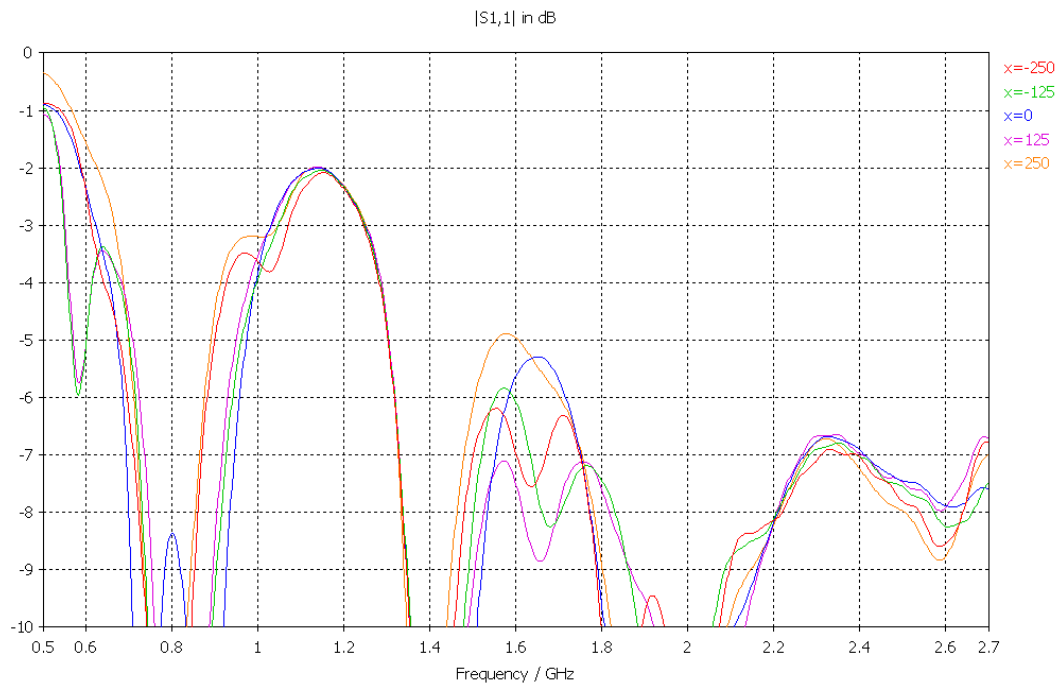

4.0 S11 Measurement

Six different ground plane configurations have been tested:

- 1) Orthogonally displaced on the edge of an 80 x 40 mm² groundplane;
- 2) Co-planarly displaced on the edge of an 80 x 40 mm² groundplane;
- 3) Orthogonally displaced on the edge of a 100 x 40 mm² groundplane;
- 4) Co-planarly displaced on the edge of a 100 x 40 mm² groundplane;
- 5) Orthogonally displaced on the edge of a 200 x 200 mm² groundplane;
- 6) Co-planarly displaced on the edge of a 200 x 200 mm² groundplane.

The antenna presents a versatile behaviour and offers a good impedance matching and radiation performance for different grounding solutions. In particular, it offers 6 dB return loss bands (5 dB at the edge) over the ranges 690 – 960 MHz and 1.71 – 2.69 GHz (LTE bands) for the configurations 4, 5 and 6. But for the configurations 1 and 2 its performance is very close to LTE requirements.

This suggests that this antenna can be allocated into small devices either orthogonally or co-planarly displaced at the edge of the chipboard. The co-planar configuration might be suitable for small (~ 80/100 x 40 x 33 mm³) and low-profile devices.



Specification

4.1 Orthogonally displaced on 80*40 mm² ground plane;

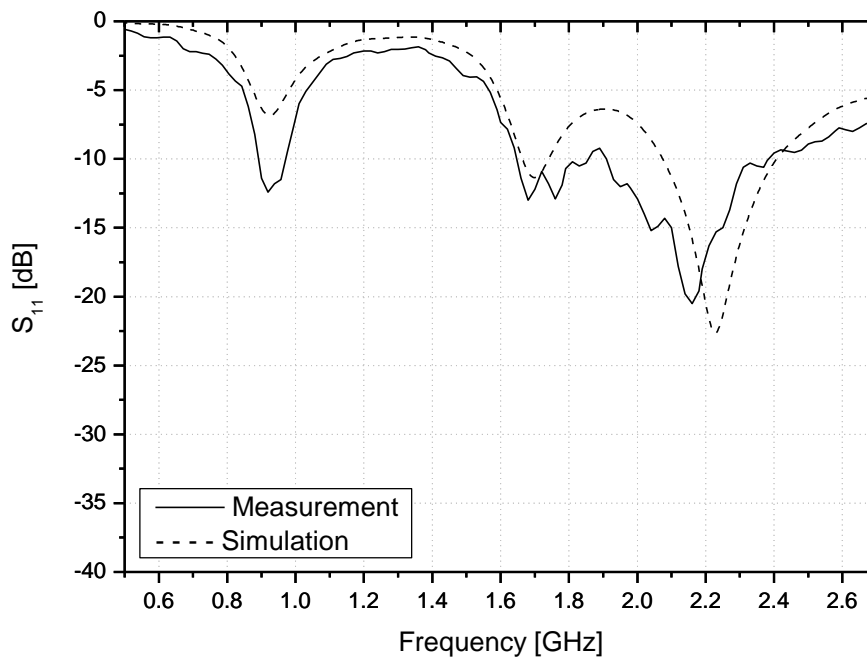
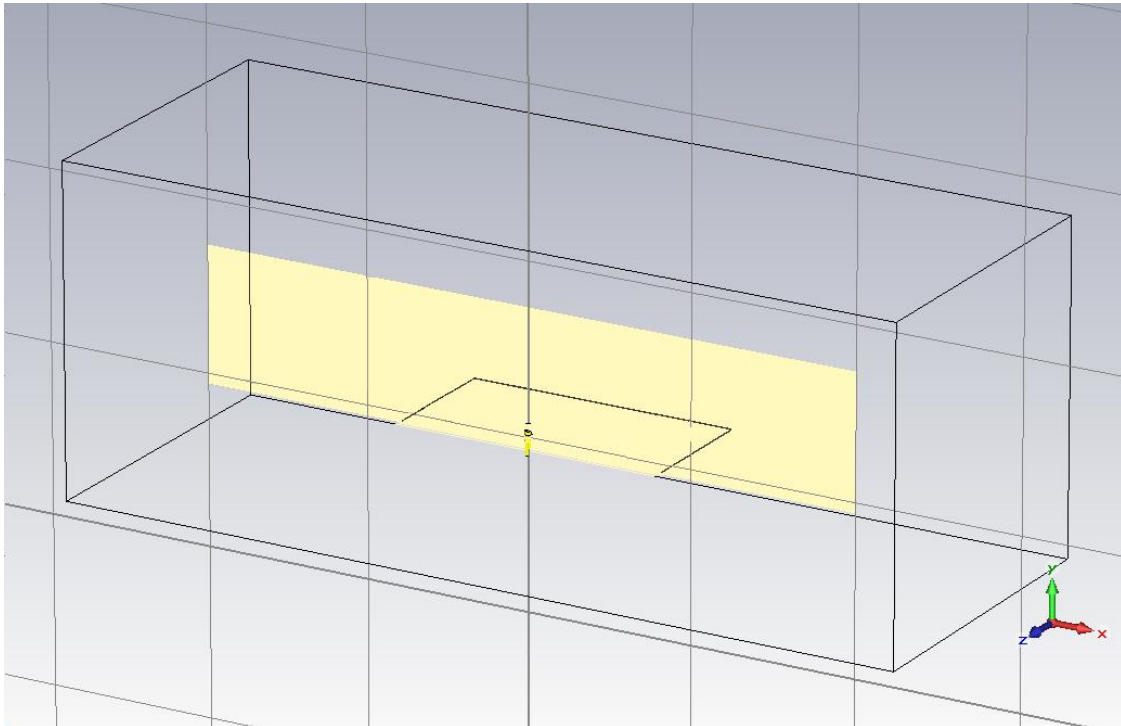

5dB bands on measurement: 0.85 – 1.03 GHz, 1.57 – 3.39 GHz



Specification

4.2 Co-planarly displaced on 80-*40 mm² ground plane;

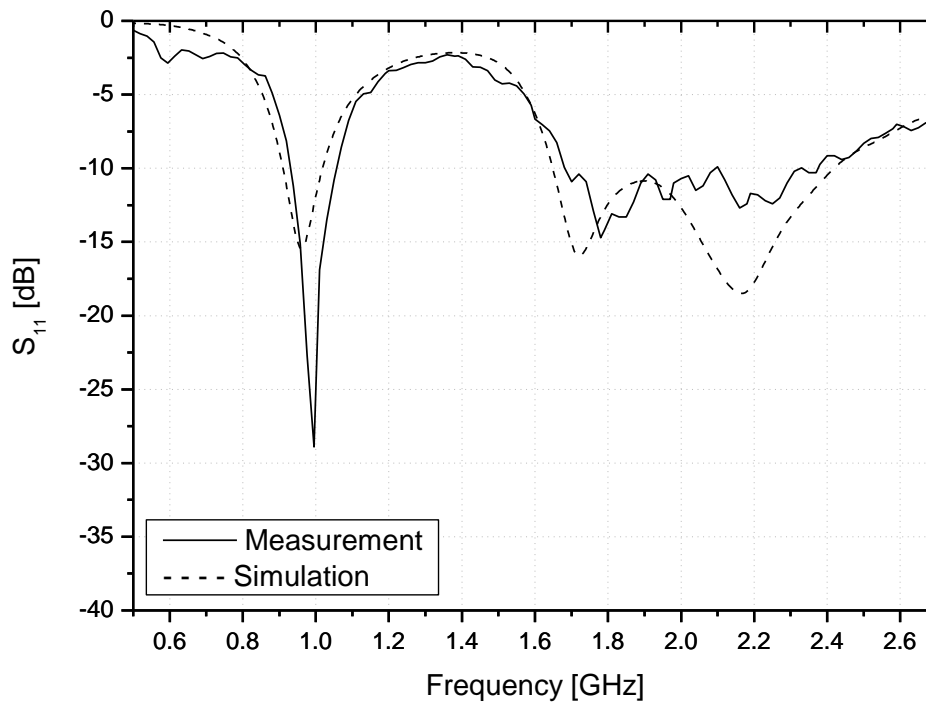
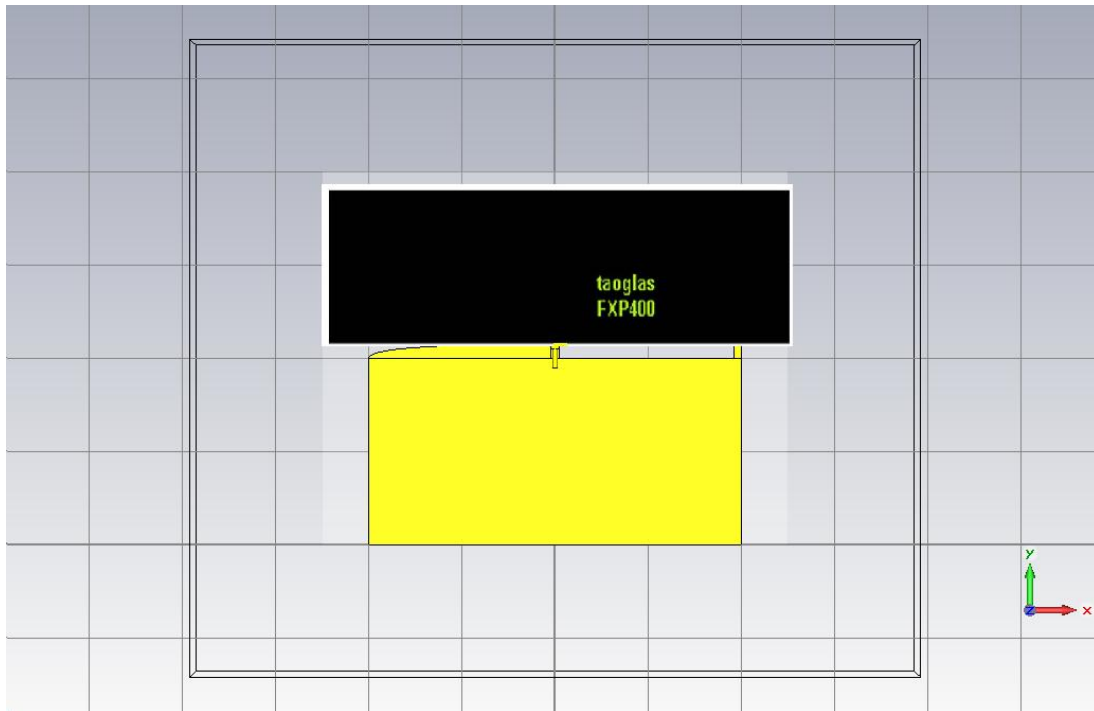

5dB bands on measurement: 0.85 – 1.12 GHz, 1.59 – 3.39 GHz

© All Rights Reserved



Specification

4.3 Orthogonally displaced on 100*40 mm² ground plane;

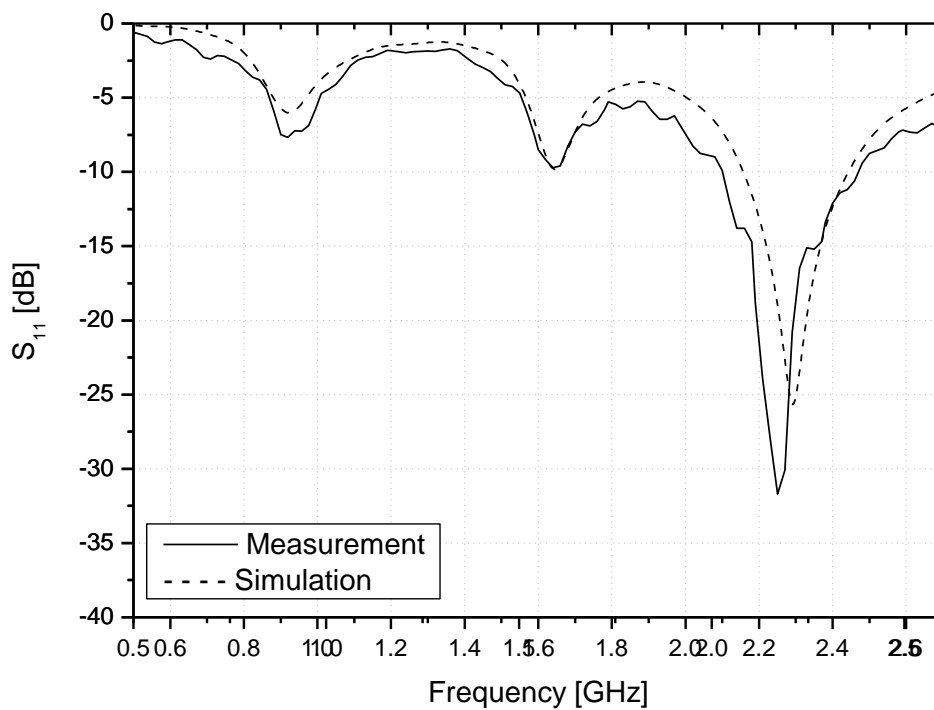
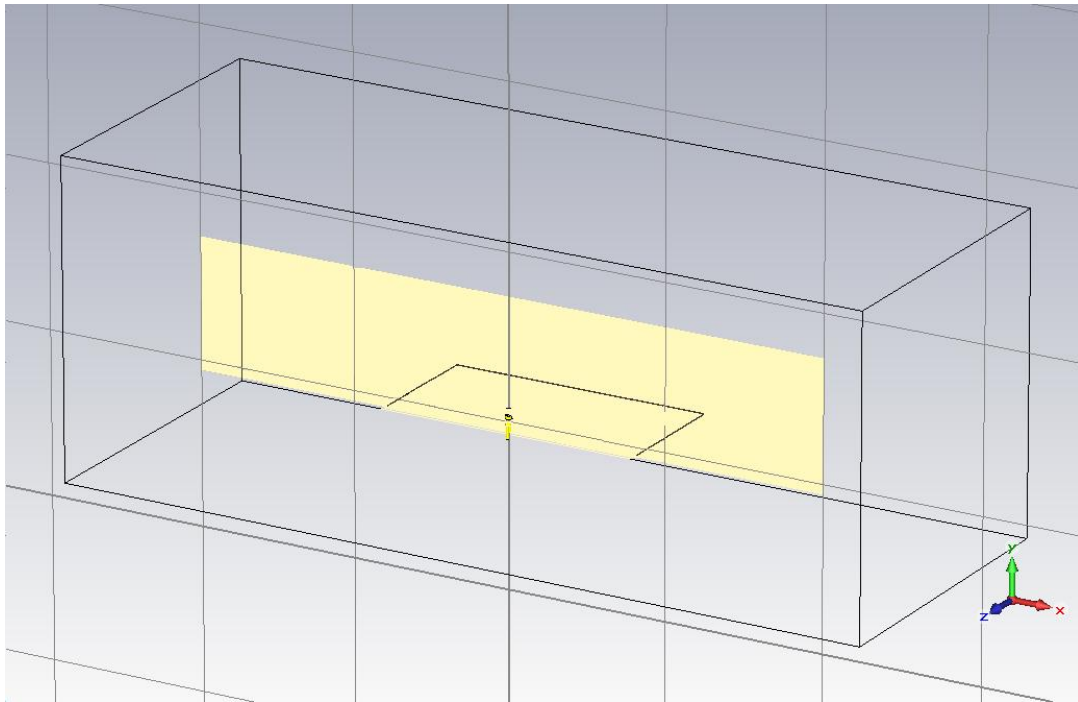

5dB bands on measurement: 0.87 – 0.995 GHz, 1.56 – 3.09 GHz



Specification

4.4 Co-planarly displaced on 100*40 mm² ground plane;

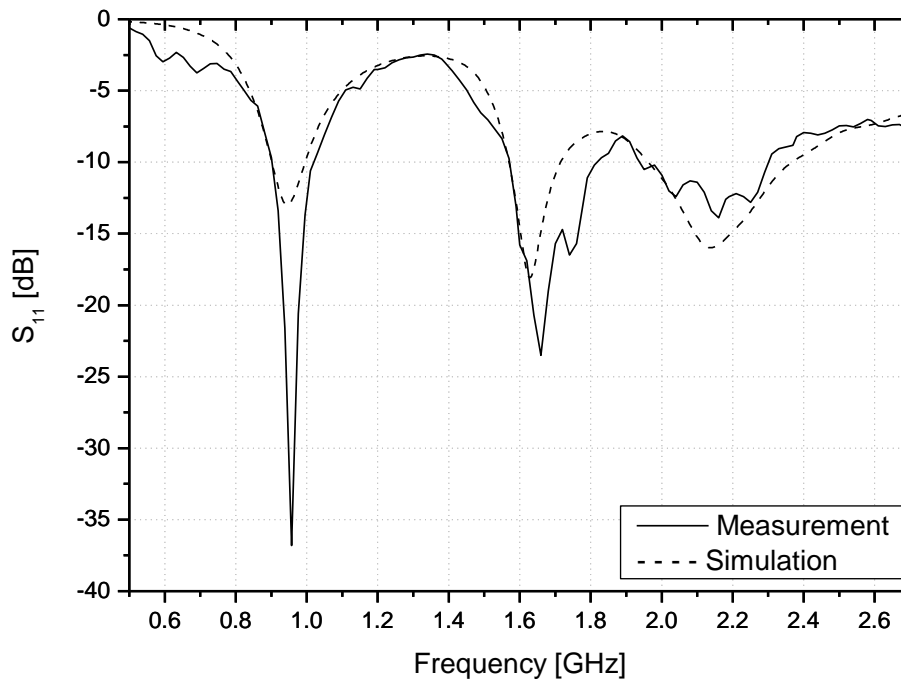
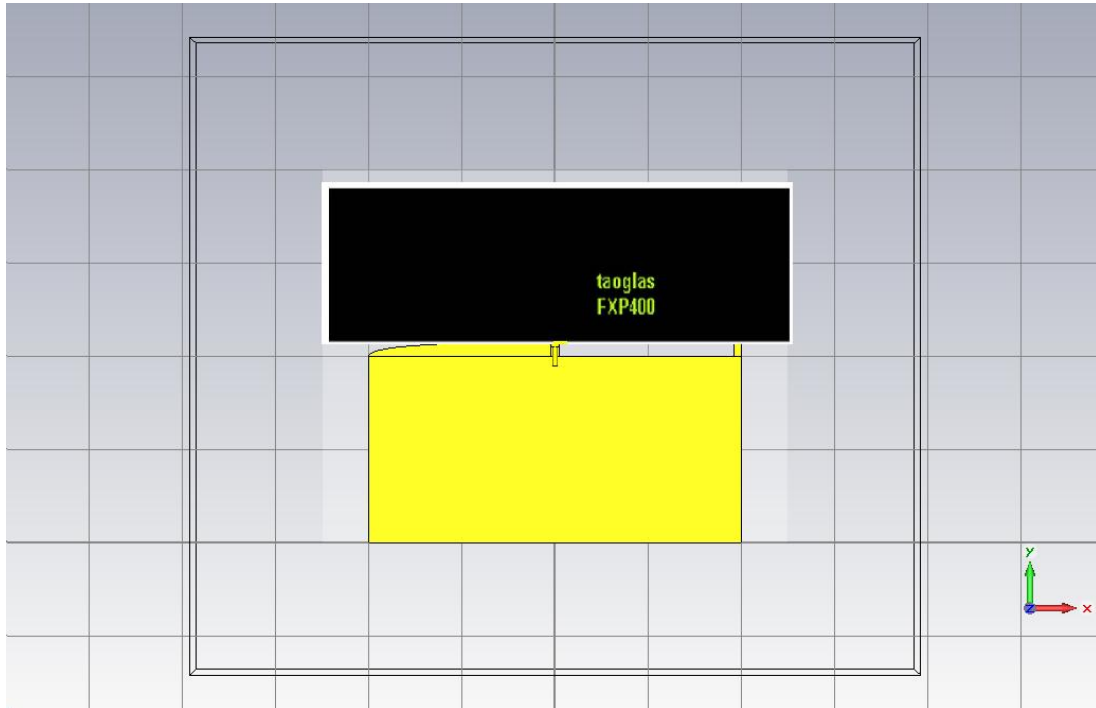

5dB bands on measurement: 0.83 – 1.1 GHz, 1.47 – 3.37 GHz



4.5 Orthogonally displaced on 200*200 mm² ground plane;

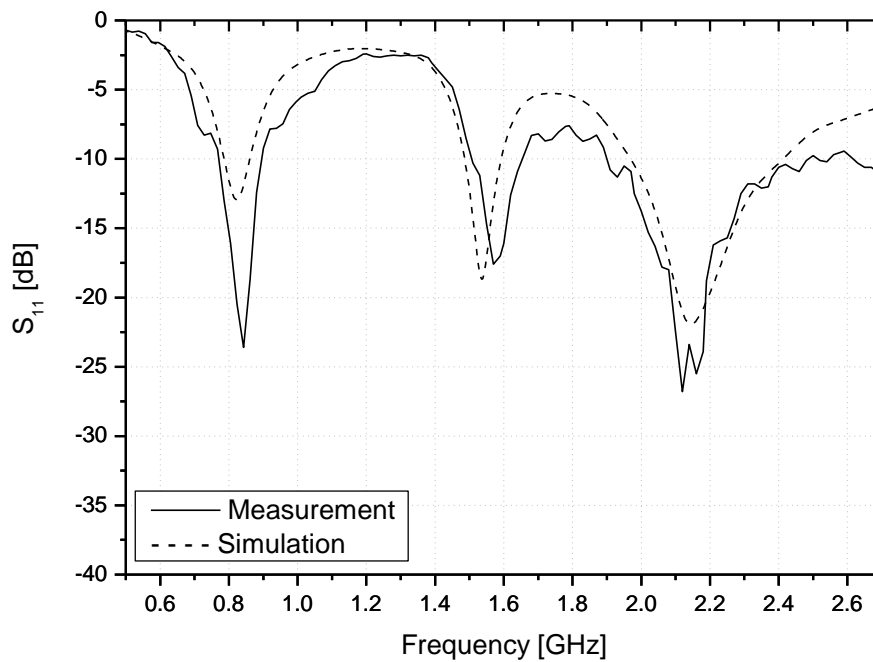
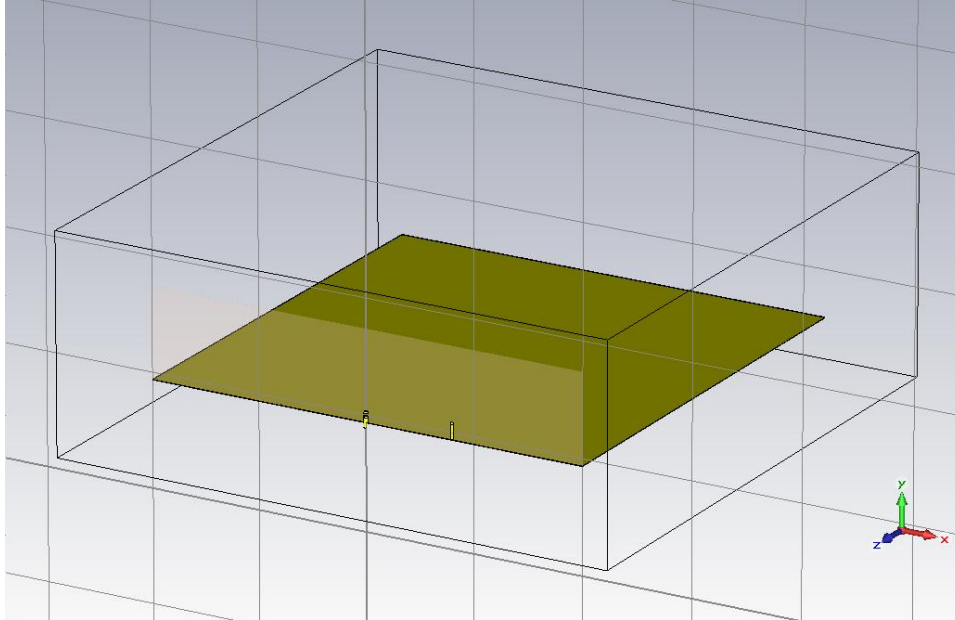

5dB bands on measurement: 0.69 – 1.05 GHz, 1.47 – 3.28 GHz



Specification

4.6 Co-planarly displaced on 200*200 mm² ground plane.

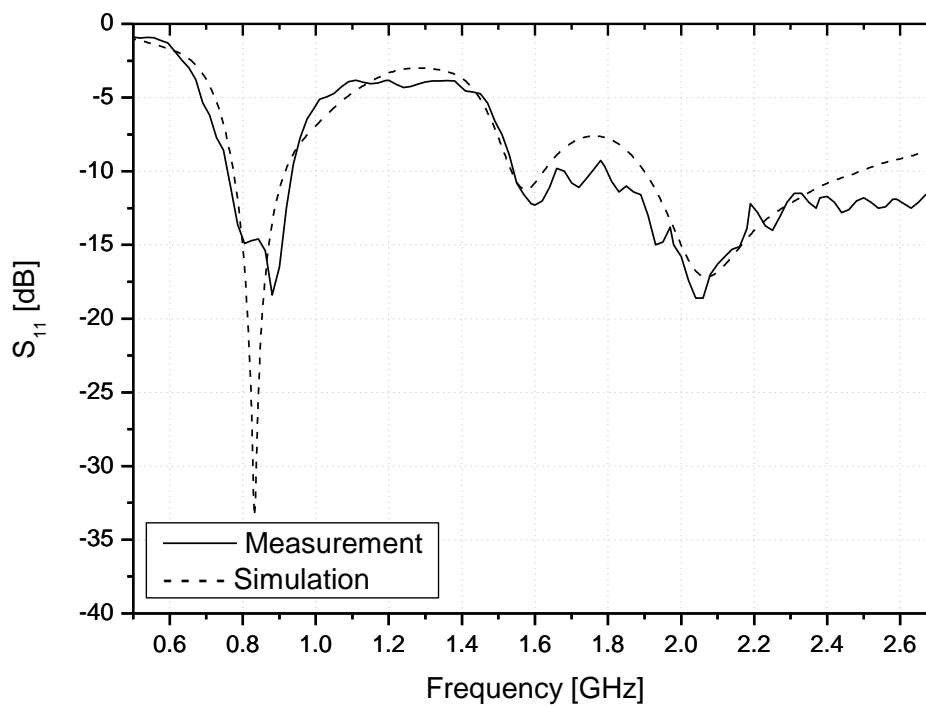
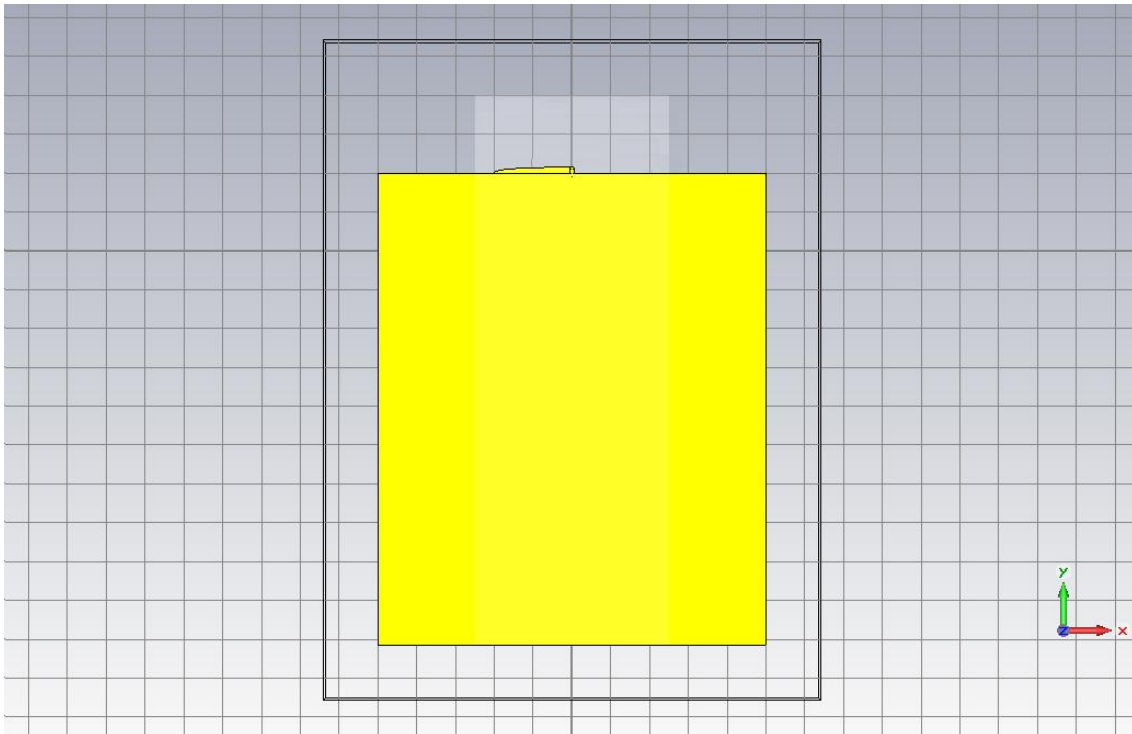

5dB bands on measurement: 0.69 – 1.01 GHz, 1.47 – 3.3 GHz



5. Antenna Efficiency and Gain

We have tested both orthogonally displaced and co-planarly displaced configuration for all ground planes. These two different mounting provide the same antenna efficiency and gain.



Co-planarly displaced

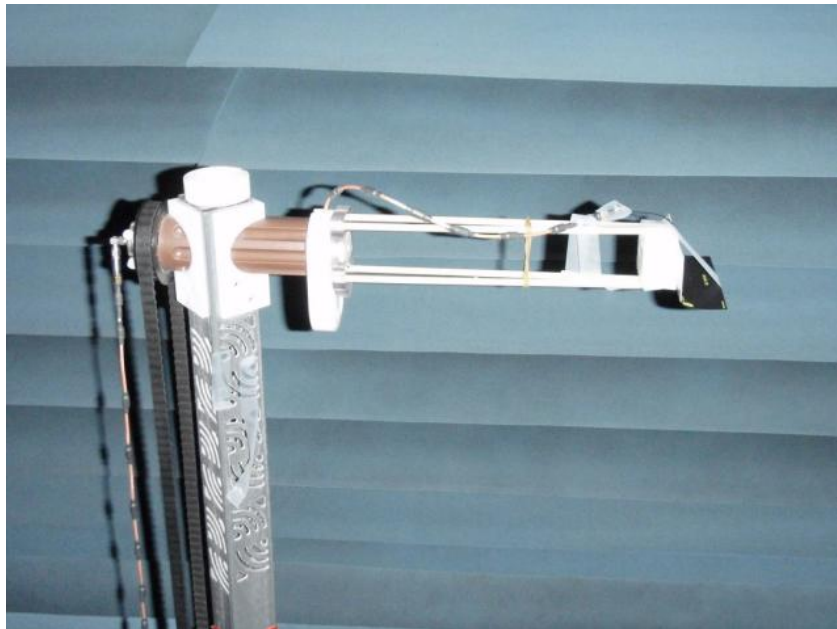

Orthogonally displaced



5.1 80*40 mm² ground plane

Antenna Efficiency of FXP.400 with 80mm Ground

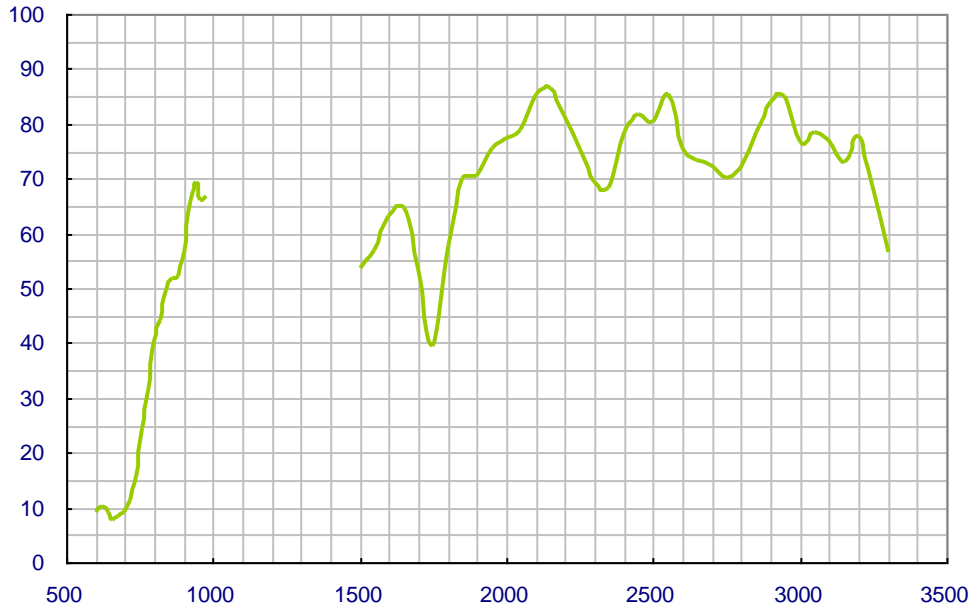

Antenna Gain of FXP.400 with 80mm Ground

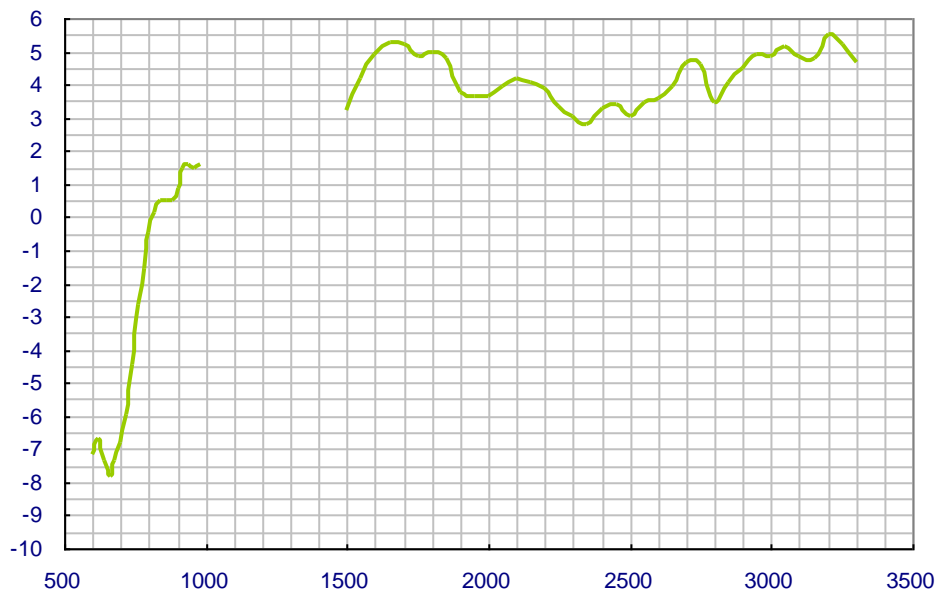



5.2 100*40 mm² groundplane

Antenna Efficiency of FXP.400 with 100mm Ground

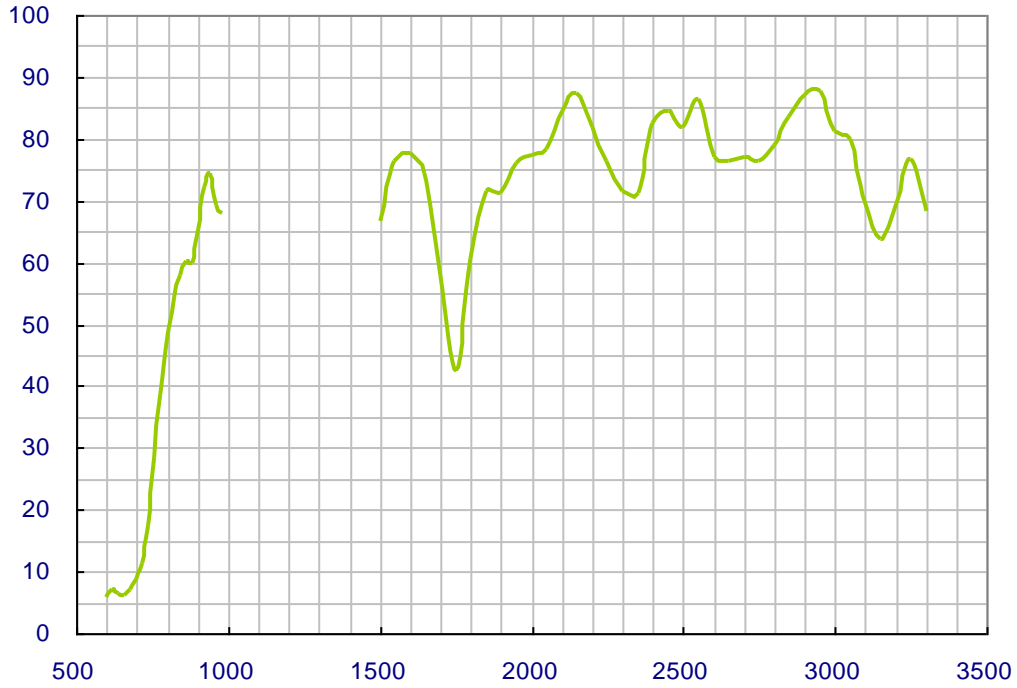

Antenna Gain of FXP.400 with 100mm Ground

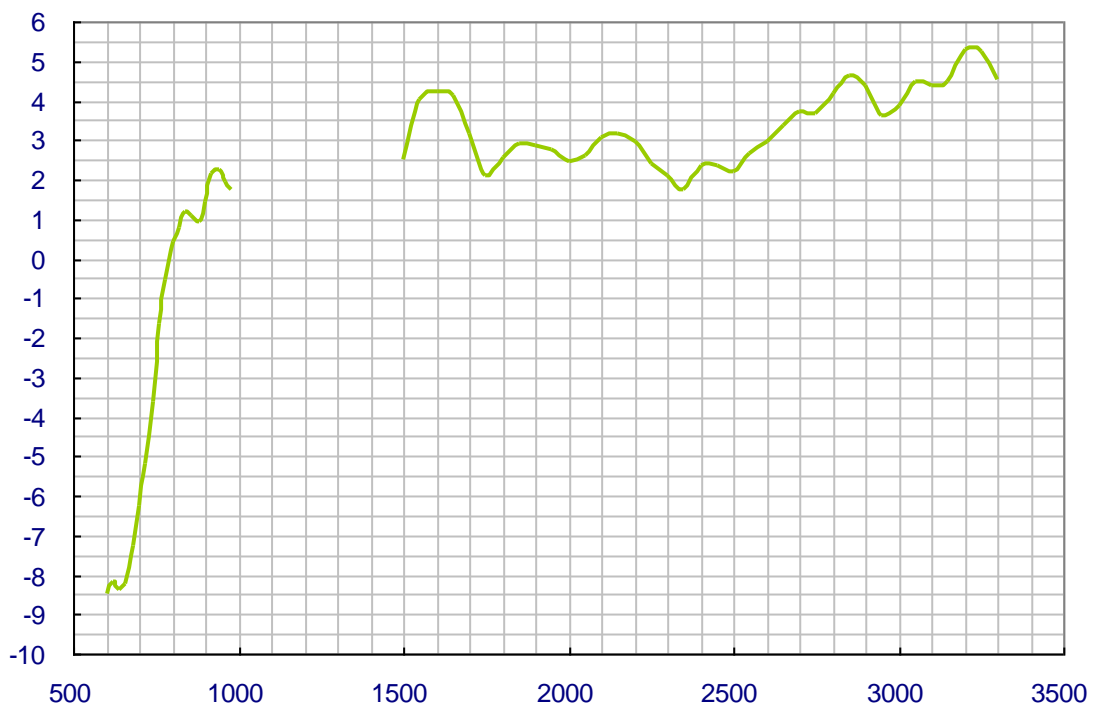



5.3 200*200 mm² ground plane

Antenna Efficiency of FXP.400 with 200mm ground

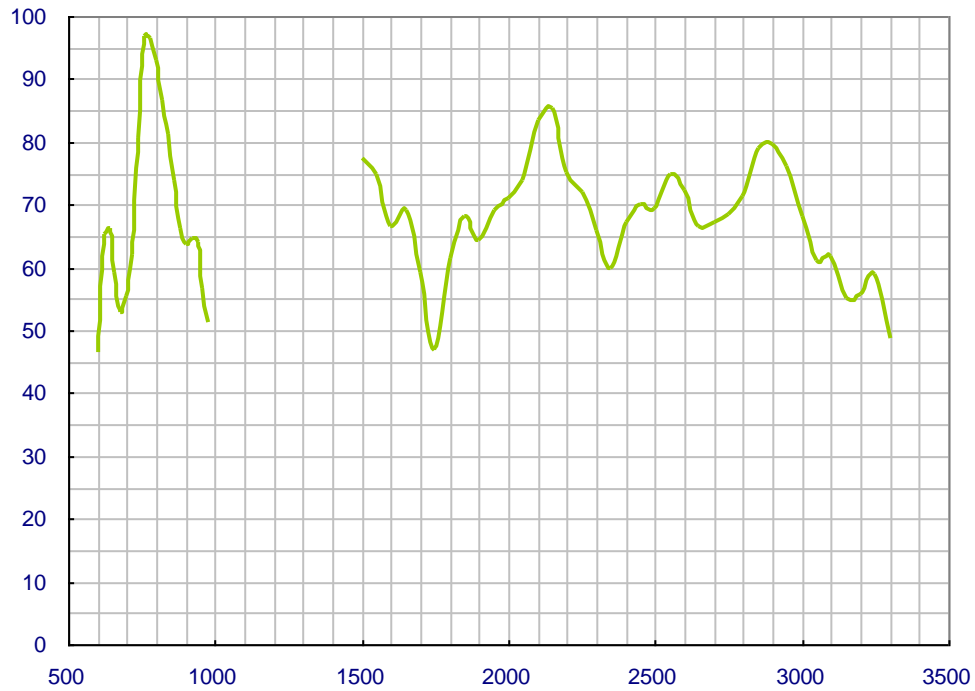

Antenna Gain of FXP.400 with 200mm ground

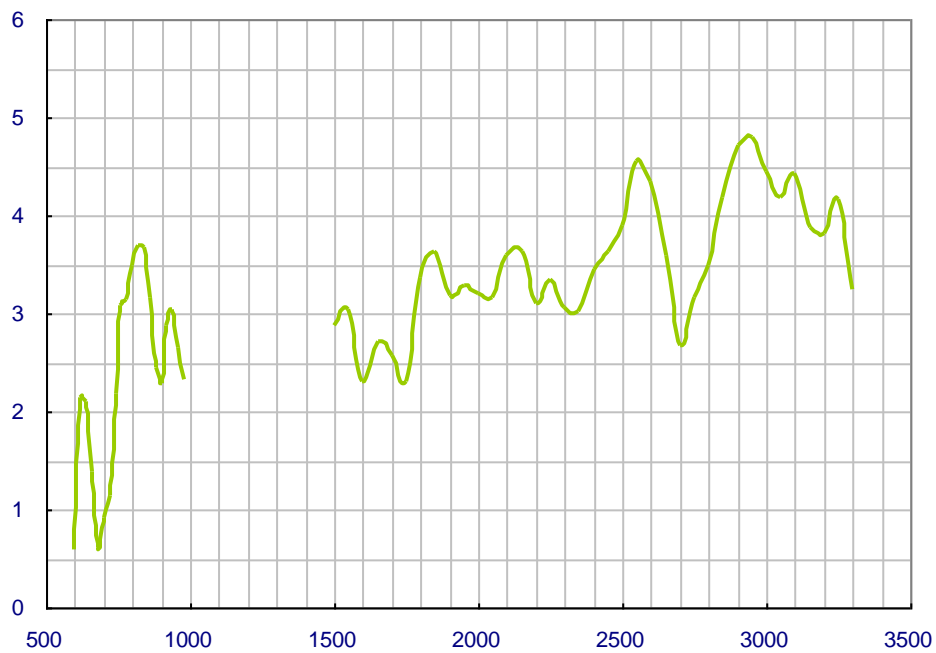



Specification

Simulated radiation patterns (xy-cut)

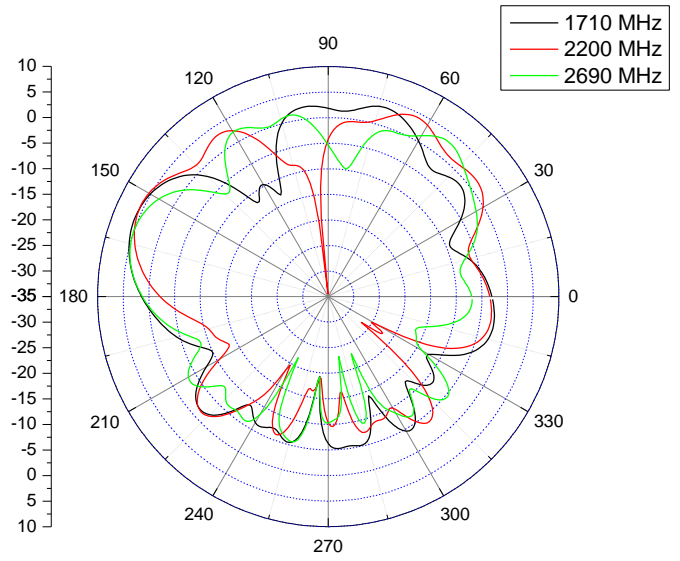
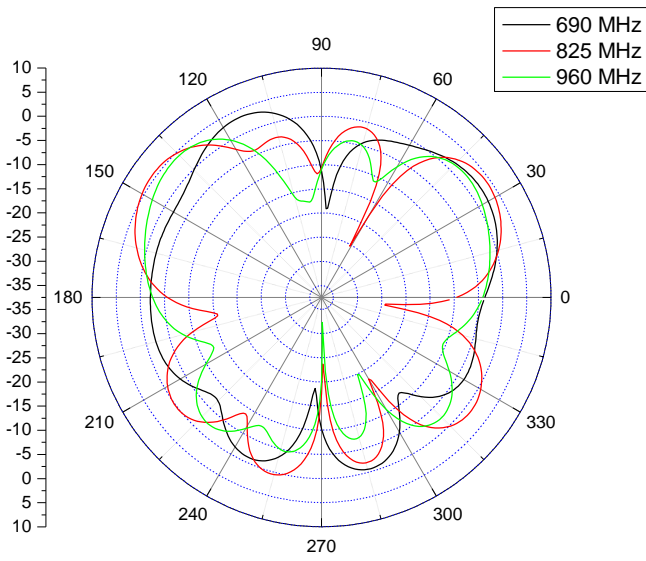

Simulated radiation patterns (xz-cut)

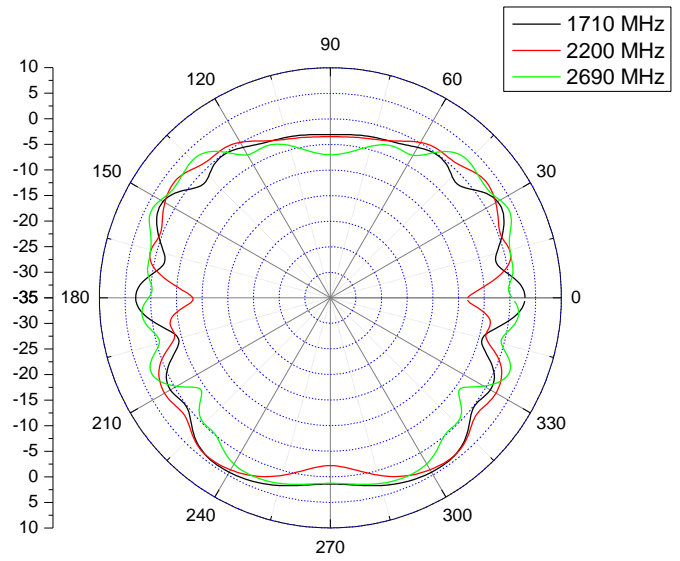
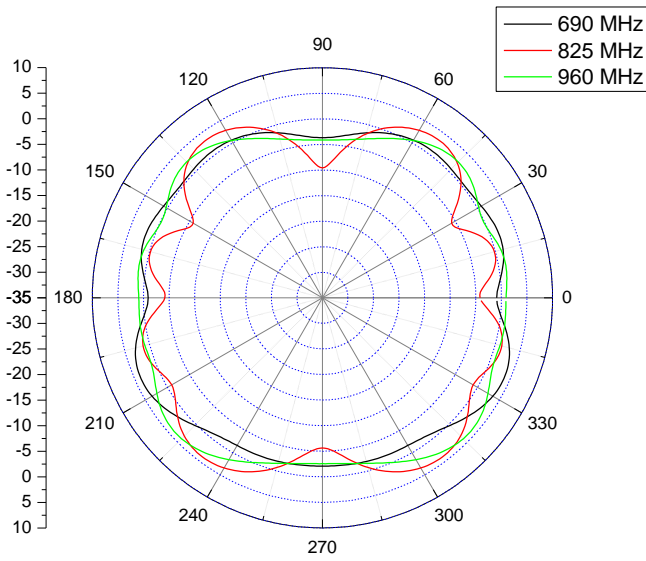



Simulated radiation patterns (yz-cut)

