

# C&K L Series Miniature Slide Switches

## Features/Benefits

- Positive detent
- Enclosed housing
- Maintained and momentary functions
- PC and panel mounting
- RoHS compliant

## Typical Applications

- Communications equipment
- Lighting devices

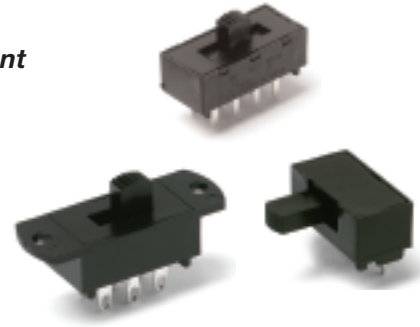

## Specifications

**CONTACT RATING:** Q contact material (LX0X, LX1X Models): 4 AMPS @ 125 V AC or 28 V DC; 2 AMPS @ 250 V AC; 0.5 AMP @ 125 V DC (UL/CSA). See page I-23 for additional ratings.

**ELECTRICAL LIFE:** 10,000 make-and-break cycles at full load.

**CONTACT RESISTANCE:** Below 10 m Ω typ. initial @ 2-4 V DC, 100 mA, for both silver and gold plated contacts.

**INSULATION RESISTANCE:** 10<sup>9</sup> Ω min.

**DIELECTRIC STRENGTH:** 1,000 Vrms min. @ sea level.

**OPERATING TEMPERATURE:** -30°C to +65°C

**STORAGE TEMPERATURE:** -30°C to +85°C

**NOTE:** Specifications and materials listed above are for switches with standard options. For information on specific and custom switches, consult Customer Service Center.

## Materials

**HOUSING:** 6/6 nylon (UL94V-2), black.

**ACTUATOR:** 6/6 nylon (UL94V-2), black. '13' actuator, natural (standard).

**CONTACTS:** Q contact material: Copper, silver plated. See page J-22 for additional contact materials.

**TERMINALS:** Q contact material: Copper, silver plated. See page J-22 for additional contact materials.

**CONTACT SPRING:** Music wire or stainless steel.

**TERMINAL SEAL:** Epoxy.

**NOTE:** Any models supplied with Q, B or G contact material are RoHS compliant. For the latest information regarding RoHS compliance, please go to: [www.ittcannon.com/rohs](http://www.ittcannon.com/rohs).

## Build-A-Switch

To order, simply select desired option from each category and place in the appropriate box. Available options are shown and described on pages J-19 through J-23. For additional options not shown in catalog, consult Customer Service Center.

<p><b>Switch Function</b></p> <p><b>L202</b> DPDT</p> <p><b>L203</b> DP3T</p> <p><b>L101</b> SPST</p> <p><b>L102</b> SPDT</p> <p><b>L103</b> SP3T</p> <p><b>L104</b> SP4T</p> <p><b>L112</b> SPDT, mom.</p> <p><b>L113</b> SP3T, mom. to one end</p> <p><b>L123</b> SP3T, mom. to both ends</p> <p><b>L201</b> DPST</p> <p><b>L204</b> DP4T</p> <p><b>L212</b> DPDT, mom.</p>	<p><b>Actuator</b></p> <p><b>01</b> .200" high</p> <p><b>02</b> .335" high</p> <p><b>03</b> .375" high</p> <p><b>05</b> .312" high</p> <p><b>11</b> .100" high</p> <p><b>12</b> Screwdriver slot</p> <p><b>13</b> Plunger without cap</p> <p><b>14</b> Plunger with .200" dia. cap</p> <p><b>15</b> Plunger with .310" dia. cap</p> <p><b>17</b> Plunger with .458" dia. cap</p> <p><b>19</b> Plunger with .590" dia. cap</p>	<p><b>Detent</b></p> <p><b>1</b> With detent</p> <p><b>2</b> Without detent</p>	<p><b>Mounting Style</b></p> <p><b>MS</b> PC Thru-hole</p> <p><b>MA</b> Right angle, PC thru-hole</p> <p><b>ML</b> Right angle, PC thru-hole</p> <p><b>MV</b> Right angle, PC thru-hole</p> <p><b>SS</b> Panel with mounting ears</p> <p><b>TS</b> Panel with integral mounting ears</p>	<p><b>Terminations</b></p> <p><b>02</b> PC Thru-hole</p> <p><b>01</b> Solder lug with notch</p> <p><b>03</b> Solder lug with hole</p> <p><b>04</b> PC Thru-hole</p> <p><b>10</b> PC Thru-hole</p> <p><b>06</b> Wire wrap</p> <p><b>12</b> PC Thru-hole</p>	<p><b>Contact Material</b></p> <p><b>Q</b> Silver</p> <p><b>B</b> Gold</p> <p><b>G</b> Gold over silver</p>	<p><b>Seal</b></p> <p><b>NONE</b> No seal</p> <p><b>E</b> Epoxy seal</p>	<p><b>Cap Color</b></p> <p><b>2</b> Black</p> <p><b>NONE</b> No cap</p>
---	---	---	--	--	---	--	---



Dimensions are shown: Inch (mm)  
Specifications and dimensions subject to change

# C&K L Series Miniature Slide Switches

## SWITCH AND LOCK FUNCTION



NO. POLES	MODEL NO.	SWITCH FUNCTION	SCHEMATIC	AVAILABLE MOUNTING STYLES
SP	L101	SPST		ML, MS, SS
	L102	SPDT		ML, MS, SS
	L112	SPDT-MOM.		ML, MS, MV, SS
	L103	SP3T		MA, MS, TS
	L113	SP3T-MOM. to one end		MA, MS, TS
	L123	SP3T-MOM. to both ends		MA, MS, TS
	L104	SP4T		MS

NO. POLES	MODEL NO.	SWITCH FUNCTION	SCHEMATIC	AVAILABLE MOUNTING STYLES
DP	L201	DPST		MA, MS, SS
	L202	DPDT		MA, MS, SS
	L212	DPDT-MOM.		MV
	L203	DP3T		MS, TS
	L204	DP4T		MS

**NOTE:** and MOM. in table indicates momentary action.

All models with all options when ordered with 'G' or 'Q' contact material.

Models with '01' termination option only.

Contacts make on side actuator thrown.



Slide

## ACTUATOR



### ACTUATOR OPTIONS FOR 'MS, MA, ML, SS, & TS' MOUNTING STYLES

<b>01</b> .200" HIGH 	<b>02</b> .335" HIGH 	<b>03</b> .375" HIGH 	<b>05</b> .312" HIGH 	<b>11</b> .100" HIGH 	<b>12</b> SCREWDRIVER SLOT 
--------------------------	--------------------------	--------------------------	--------------------------	--------------------------	--------------------------------

**NOTE:** No actuator color option code is required. Standard actuator color is black, other colors and heights available, consult Customer Service Center. See pages J-20 and J-22 for available mounting styles.

### ACTUATOR OPTIONS FOR 'MV' MOUNTING STYLE

<b>13</b> PLUNGER WITHOUT CAP 	<b>14</b> PLUNGER WITH CAP  Cap part number 7089	<b>15</b> PLUNGER WITH CAP  Cap part number 8018
<b>17</b> PLUNGER WITH CAP  Cap part number 7982	<b>19</b> PLUNGER WITH CAP  Cap part number 8940	

OPTION CODE	ACTUATOR CAP COLORS
<b>2</b>	BLACK
<b>NONE</b>	01-13, 23 ACTUATORS

Other colors available, consult Customer Service Center.

### ACTUATOR CAPS

Caps supplied are not installed standard. To order actuator options '14 thru 29,' select desired cap color from chart and place option code in last box of ordering format. Leave box empty for all other actuator options. Caps may also be ordered separately and user installed, see pages J-23 and J-24. Specify the four digit part number and desired cap color. For switches without caps, order '13' or '23' actuator option. Cap finish: gloss (excluding square cap part number 7982, finish: matte).

### SPLASH CAPS

New protective splash caps for PC mounted slide switches are available separately and reusable. They provide splash protection during soldering and cleaning processes. To order specify correct part number, see page J-23.



Dimensions are shown: Inch (mm)  
Specifications and dimensions subject to change

# C&K L Series Miniature Slide Switches

## DETENT

- 1 WITH DETENT**  
Standard with all maintained models: L101, L102, L103, L104, L113, L201, L202, L203 and L204.
- 2 WITHOUT DETENT**  
Standard with all momentary models: L112, L123, and L212.

## MOUNTING STYLE



Slide

### MS PC THRU-HOLE, 2 POSITION MODELS

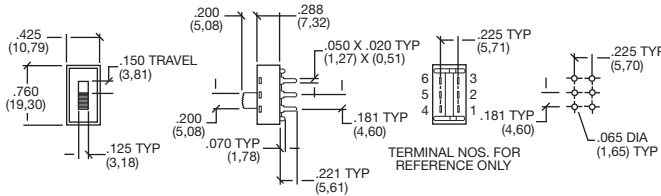

### PC THRU-HOLE, 3 POSITION MODELS

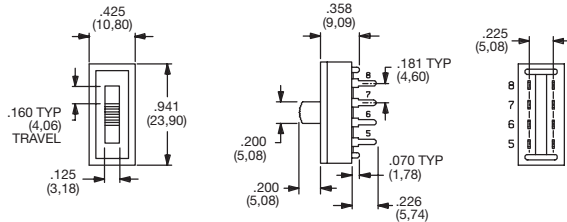

### PC THRU HOLE, 4 POSITION MODELS

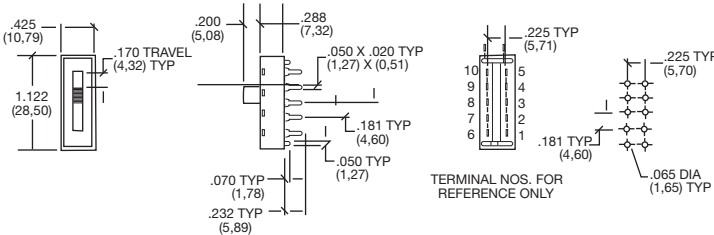

#### AVAILABLE WITH:

**Models:** L101, L102, L112, L103, L113 L123, L201, L202, L203, L104 and L204  
**Terminations:** 02, 06, 10 and 12  
**Actuators:** 01, 02, 03, 05, 11 and 12

#### PC MOUNTING

For mounting information, see TERMINATIONS section, page J-21.  
Splash caps are available separately and reusable, see page J-23.



L203011MS02Q  
DP3T

### MA RIGHT ANGLE, PC THRU-HOLE

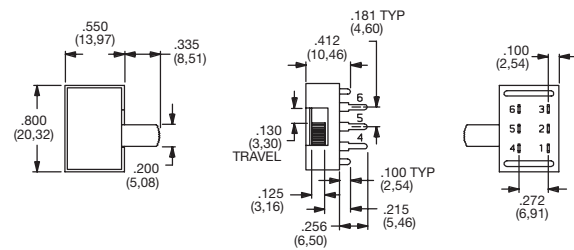

#### AVAILABLE WITH:

**Models:** L201, L202, L113 and L123  
**Terminations:** 04  
**Actuators:** 02 and 12

#### PC MOUNTING

For mounting information, see TERMINATIONS section, page J-21.  
Splash caps are available separately and reusable, see page J-23.



L202021MA04Q  
Horizontal Actuation  
DP3T

### RIGHT ANGLE, PC, SP-3 POSITION MODELS

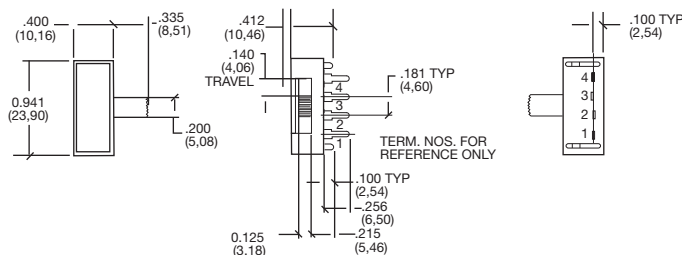

Third Angle  
Projection

Dimensions are shown: Inch (mm)  
Specifications and dimensions subject to change



# C&K L Series Miniature Slide Switches

## MOUNTING STYLE



### ML RIGHT ANGLE, PC THRU-HOLE

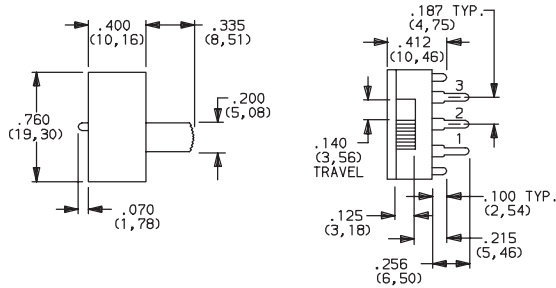

#### AVAILABLE WITH:

**Models:** L101, L102, L112  
**Terminations:** 04  
**Actuators:** 01, 02, 05, 11 and 12  
**PC MOUNTING**

For mounting information, see  
**TERMINATIONS** section, page J-21.  
 Splash caps are available separately  
 and reusable, see page J-23.



**L102021ML04Q**  
 Horizontal Actuation  
**SPDT**

### MV RIGHT ANGLE, PC THRU-HOLE

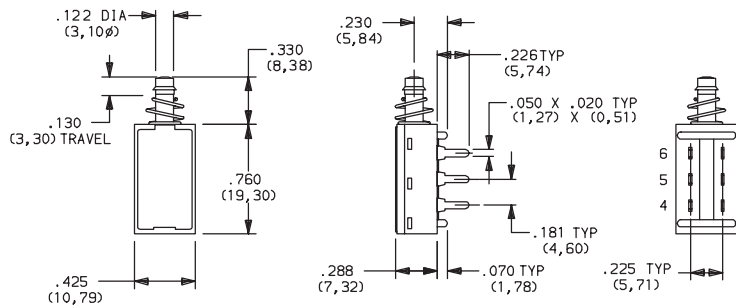

#### AVAILABLE WITH:

**Models:** L112 and L212  
**Terminations:** 02, 06, 10 and 12  
**Actuators:** 13 thru 19

#### PC MOUNTING

For mounting information, see  
**TERMINATIONS** section, page J-21.  
 Splash caps are available separately  
 and reusable, see page J-23.



**L212132MV02Q**  
**DPDT**

### SS PANEL WITH MOUNTING EARS



**L202011SS03Q**  
**DPDT**

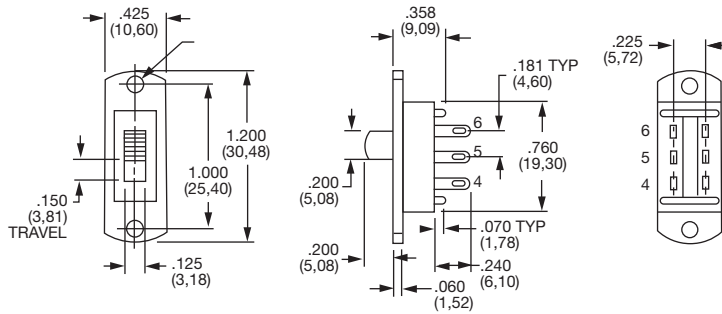

#### PANEL MOUNTING

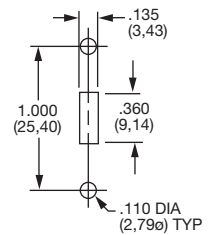

#### AVAILABLE WITH:

**Models:** L101, L102, L112, L201 and L202  
**Terminations:** 01, 02, 03, 06, 10, 12  
**Actuators:** 01, 02, 03, 05, 11 and 12

### TS PANEL WITH INTEGRAL MOUNTING EARS



**L203011TS03Q**  
**DP3T**

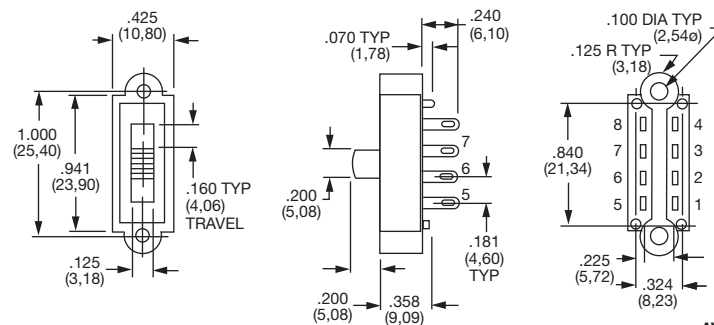

#### PANEL MOUNTING

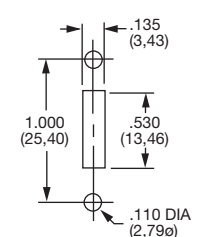

#### AVAILABLE WITH:

**Models:** L103, L113, L123 and L203  
**Terminations:** 01, 02, 03, 06, 10, 12  
**Actuators:** 01, 02, 03, 05, 11 and 12

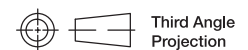

Dimensions are shown: Inch (mm)  
 Specifications and dimensions subject to change

# C&K L Series Miniature Slide Switches

## TERMINATIONS

'MS, MV, SS & TS' Mounting Styles Only

**02** PC THRU-HOLE

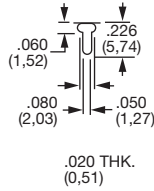

**01** SOLDER LUG WITH NOTCH

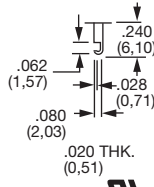

'01' terminations only.

**03** SOLDER LUG WITH HOLE

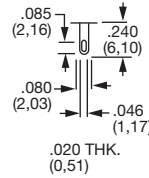

**10** PC THRU-HOLE

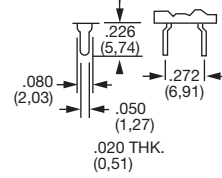

**12** PC THRU-HOLE

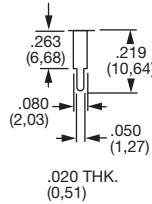

**06** WIRE WRAP

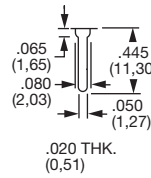

'MA & ML' Mounting Styles Only

**04** PC THRU-HOLE

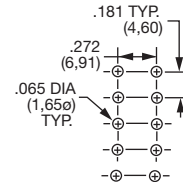
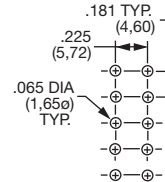
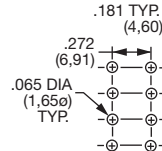
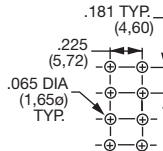
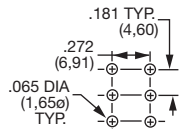
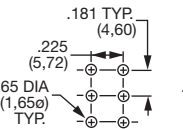
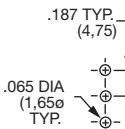
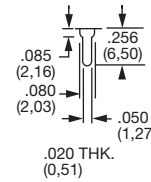

All models with '04' terminations and 'ML' mounting style.

All 2 position models, except '04' terminations.

All 2 position models with '04' terminations and 'MA' mounting style.

All 2 position models with '04' terminations and 'MA' mounting style.

All 3 position models, except '04' terminations.

All 3 position models, with '10' terminations.

All 4 position models, with '10' terminations.

## CONTACT MATERIAL

OPTION CODE	RoHS COMPLIANT	RoHS COMPLIANT	CONTACT MATERIAL	RATINGS	
<b>Q</b>	YES	YES	SILVER <sup>2</sup>	LOW LEVEL/DRY CIRCUIT	LX0X, LX1X MODELS: 4 AMPS @ 125 V AC or 28 V DC; 2 AMPS @ 250 V AC; 0.5 AMP @ 125 V DC (UL/CSA). LX6X MODELS: 4 AMPS @ 125 V AC or 28 V DC; 2 AMPS @ 250 V AC (UL/CSA).
<b>B</b>	YES	YES	GOLD <sup>1</sup>	POWER	0.4 VA MAX. @20 V AC OR DC max.
<b>G</b>	YES	YES	GOLD OVER SILVER <sup>3</sup>	LOW LEVEL/DRY CIRCUIT OR POWER	LX0X, LX1X MODELS: 0.4 VA MAX. @ 20 V AC or DC MAX. or 4 AMPS @ 125 V AC or 28 V DC; 2 AMPS @ 250 V AC (UL/CSA). LX6X MODELS: 0.4 VA MAX. @ 20 V AC or DC MAX. or 4 AMPS @ 125 V AC or 28 V DC; 2 AMPS @ 250 V AC (UL/CSA).

\* Note: See Technical Data section of this catalog for RoHS compliant and compatible definitions and specifications.

<sup>1</sup> CONTACTS & TERMINALS: Copper, with gold plate over nickel plate.

<sup>2</sup> CONTACTS & TERMINALS: Copper, silver plated (standard with all termination options).

<sup>3</sup> CONTACTS & TERMINALS: Copper, with gold plate over nickel plate over silver plate.

**NOTE:** Any models supplied with Q, B or G contact material are RoHS compliant. For the latest information regarding RoHS compliance, please go to: [www.ittcannon.com/rohs](http://www.ittcannon.com/rohs).

All models with all options (except '01' termination) when ordered with 'G' or 'Q' contact material.

Models with '01' termination option only.

**NOTE:** 'G' contact material is equivalent to both 'B' and 'Q' contact materials.

## SEAL

**NONE** NO SEAL

**E** EPOXY SEAL

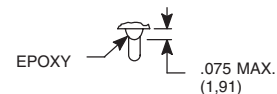

Third Angle Projection  
Dimensions are shown: Inch (mm)  
Specifications and dimensions subject to change



Slide

# C&K L Series Miniature Slide Switches

## AVAILABLE HARDWARE

Cap  
Compatible with 13-19 actuators

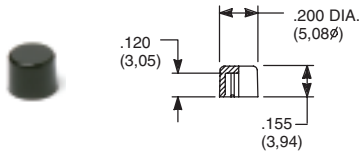

**PART NO.**  
**708902000** BLACK  
**708903000** RED

Material: Nylon  
Finish: Gloss

Cap  
Compatible with 13-19 actuators

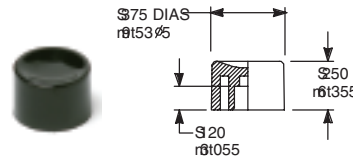

**PART NO.**  
**752702000** BLACK  
**752703000** RED

Material: Nylon  
Finish: Gloss

Cap  
Compatible with 13-19 actuators

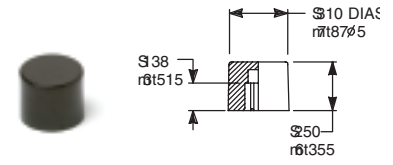

**PART NO.**  
**801802000** BLACK  
**801803000** RED

Material: Nylon  
Finish: Gloss

Cap  
Compatible with 13-19 actuators

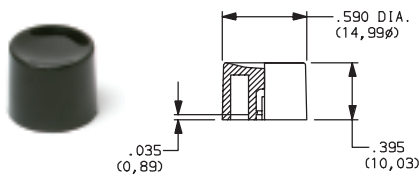

**PART NO.**  
**894002000** BLACK  
**894003000** RED

Material: Nylon  
Finish: Gloss

Cap  
Compatible with 13-19 actuators

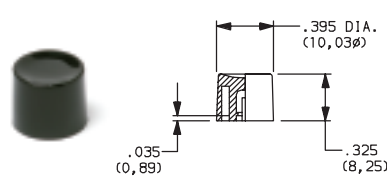

**PART NO.**  
**894102000** BLACK  
**894103000** RED

Material: Nylon  
Finish: Gloss

Cap  
Compatible with 13-19 actuators

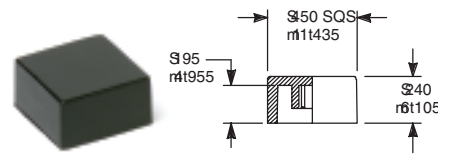

**PART NO.**  
**484602000** BLACK  
**484603000** RED

**PART NO.**  
**798202263** BLACK  
**798203000** RED

Material: Nylon  
Finish: Gloss

Material: Nylon  
Finish: Matte

Cap  
Compatible with 01-05 actuators

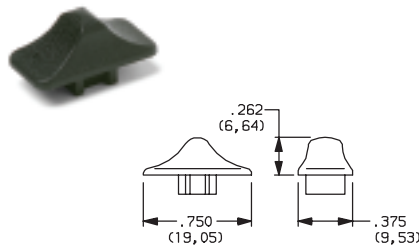

**PART NO.**  
**120100602** BLACK

Material: Nylon  
Finish: Matte

Splash Cap



Fits 'MS' mounting style,  
LXX1 & LXX2 models only.

**PART NO.**  
**120100200**

Material: Nylon

Splash Cap



Fits 'MV' mounting style,  
LX1X models only.

**PART NO.**  
**120100300**

Material: Nylon

Splash Cap



Fits 'MA' mounting style,  
LXX3 models only.

**PART NO.**  
**120100400**

Material: Nylon

**NOTE:** Other colors available,  
consult Customer Service Center.

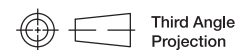

Dimensions are shown: Inch (mm)  
Specifications and dimensions subject to change



Slide