

SPECIFICATION

Part No. : MA250.A.LBI.001

Product Name : Sentinel Adhesive Mount
3in1 LTE MIMO + GNSS Antenna

Feature : Ideal for IoT and Automotive Applications
Smallest High Performance MIMO

- 2 x LTE 4G/3G/2G MIMO 1&2 Antennas
- 1 x GPS-GLONASS-BeiDou L1 Active Antenna

IP67 Waterproof
High Efficiency
Low Profile Housing – Only 14mm in Height
2M CFD-200 and RG-174 Cables
SMA(M) Connectors
Dims: 139*76*14mm
RoHS Compliant





1. Introduction

The MA250 Sentinel 3in1 Adhesive Mount 4G LTE MIMO and GPS/GLONASS/BeiDou L1 antenna is an omnidirectional, fully IP67 waterproof external M2M antenna for use in telematics, transportation and remote monitoring applications worldwide. It is designed to be mounted directly on glass or plastic in the interior of vehicles.

It is the smallest high performance solution in the market, 50% smaller than the previous generation, with higher efficiency and wider bandwidth to cover emerging LTE bands. Its performance is comparable with much larger permanent roof mount antennas and now offers a convenient and economical alternative in-cabin mounting solution.

Typical applications include;

- HD video over LTE
- First Responder and Emergency Services
- Automotive vehicle tracking
- Telematics

It is mounted via high quality, first tier automotive approved, 3M adhesive.

In-house world leading dielectric ceramic antenna technology inside allows for smaller size antennas without loss in efficiency. It delivers powerful 2*2 MIMO antenna technology for worldwide 4G LTE bands at 700MHz/ 800MHz/ 1700MHz/ 1800MHz /2300MHz /2600MHz, while allowing fallback to all common worldwide 3G and 2G frequency bands. The antenna has an output for GPS-GLONASS-BeiDou for next generation location accuracy.

4G wireless applications demand high speed data uplink and downlink. High efficiency and high gain MIMO antennas are necessary to achieve the required signal to noise ratio and throughput required to solve these challenges. Taoglas also takes care to have high isolation between the two MIMO antennas to prevent self-interference. Low loss cables are used to keep efficiency high over long cable lengths.



The IP67 waterproof housing measures just 139*76*14mm with 3M foam adhesive. The antenna can be mounted internally or externally on a vehicle. Both MIMO 1 and MIMO 2 coaxial cables are 2m low loss CFD-200 with SMA(M) connectors. The GPS-GLONASS-BeiDou cable is RG-174 with SMA(M) connector.

Customized cable and connector versions are also available. The antenna also comes in a 2in1 LTE/GNSS or a single LTE only variant. Contact your regional Taoglas sales office for support.

2. Specification Table

4G/3G/2G MIMO 1 Antenna								
Frequency (MHz)		LTE700	GSM850	GSM900	DCS	PCS	UMTS1	LTE2600
		698~803	824~894	880~960	1710~1880	1850~1990	1920~2170	2490~2690
Efficiency (%)								
In free space	30cm	41.77	58.99	60.75	66.44	76.05	66.91	56.87
	1M	39.89	56.33	58.01	60.59	69.53	61.59	51.86
	2M	37.22	52.23	52.91	54.49	61.97	54.72	44.70
	3M	34.74	48.42	49.06	48.24	54.54	47.85	37.97
	5M	29.75	40.81	41.20	37.70	42.12	37.06	29.04
On 2mm ABS base	30cm	41.14	54.04	57.58	66.82	76.00	66.82	55.38
	1M	39.29	51.61	54.99	60.94	69.48	61.51	50.51
	2M	36.67	47.83	50.15	54.81	61.93	54.64	43.54
	3M	34.22	44.34	46.52	48.52	54.49	47.79	36.98
	5M	29.32	37.37	39.06	37.92	42.08	37.01	28.29
On glass base	30cm	43.33	55.50	58.33	63.40	63.83	55.87	56.49
	1M	41.38	53.00	55.71	57.82	58.35	51.42	51.52
	2M	38.62	49.13	50.81	52.03	52.01	45.69	44.42
	3M	36.04	45.54	47.12	46.04	45.77	39.95	37.74
	5M	30.91	38.38	39.57	36.00	35.35	30.95	28.86
Average Gain(dBi)								
In free space	30cm	-3.87	-2.29	-2.17	-1.81	-1.19	-1.81	-2.48
	1M	-4.07	-2.49	-2.37	-2.21	-1.58	-2.17	-2.88
	2M	-4.37	-2.82	-2.77	-2.66	-2.08	-2.68	-3.53
	3M	-4.67	-3.15	-3.10	-3.20	-2.63	-3.27	-4.23
	5M	-5.34	-3.89	-3.85	-4.26	-3.76	-4.37	-5.40
On 2mm ABS base	30cm	-3.89	-2.68	-2.41	-1.78	-1.19	-1.83	-2.60
	1M	-4.09	-2.88	-2.61	-2.18	-1.58	-2.18	-3.00
	2M	-4.39	-3.21	-3.01	-2.64	-2.08	-2.70	-3.64
	3M	-4.69	-3.54	-3.33	-3.17	-2.64	-3.28	-4.35
	5M	-5.36	-4.28	-4.09	-4.24	-3.76	-4.39	-5.51
On glass base	30cm	-3.65	-2.56	-2.34	-1.99	-1.95	-2.60	-2.50
	1M	-3.85	-2.76	-2.54	-2.39	-2.34	-2.95	-2.90
	2M	-4.15	-3.09	-2.94	-2.84	-2.84	-3.47	-3.54
	3M	-4.45	-3.42	-3.27	-3.38	-3.40	-4.05	-4.25
	5M	-5.12	-4.16	-4.03	-4.44	-4.52	-5.16	-5.41
Peak Gain(dBi)								
In free space	30cm	1.22	1.89	2.73	4.69	4.69	4.27	4.15
	1M	1.02	1.69	2.53	4.29	4.29	3.87	3.75
	2M	0.72	1.29	2.13	3.79	3.79	3.37	3.05
	3M	0.42	0.99	1.73	3.29	3.29	2.87	2.35
	5M	-0.28	0.19	1.03	2.19	2.19	1.67	1.15
On 2mm ABS base	30cm	0.76	1.57	1.79	3.68	3.68	3.22	3.24
	1M	0.56	1.37	1.59	3.28	3.28	2.86	2.84
	2M	0.26	0.97	1.19	2.78	2.78	2.36	2.14
	3M	-0.04	0.67	0.89	2.28	2.28	1.82	1.44
	5M	-0.74	-0.13	0.09	1.18	1.18	0.66	0.24
On glass base	30cm	1.86	1.94	2.06	3.10	2.90	2.90	3.66
	1M	1.66	1.74	1.86	2.70	2.50	2.50	3.26
	2M	1.36	1.44	1.46	2.30	2.00	2.00	2.56
	3M	1.06	1.14	1.06	1.70	1.40	1.40	1.86
	5M	0.46	0.34	0.36	0.70	0.30	0.30	0.75

4G/3G/2G MIMO 2 Antenna

Frequency (MHz)		LTE700	GSM850	GSM900	DCS	PCS	UMTS1	LTE2600
		698~803	824~894	880~960	1710~1880	1850~1990	1920~2170	2490~2690
Efficiency (%)								
In free space	30cm	46.24	33.45	35.37	54.05	57.08	51.87	67.48
	1M	44.16	31.95	33.78	49.29	52.17	47.71	61.55
	2M	41.21	29.61	30.81	44.42	46.50	42.38	53.09
	3M	38.46	27.44	28.56	39.27	40.93	37.07	45.10
	5M	33.09	23.13	24.00	30.73	31.59	28.70	34.48
On 2mm ABS base	30cm	50.50	40.14	42.93	53.67	56.84	53.32	66.89
	1M	48.23	38.33	41.00	48.95	51.96	49.05	61.01
	2M	45.01	35.53	37.39	44.10	46.31	43.57	52.61
	3M	42.01	32.93	34.66	39.00	40.76	38.10	44.68
	5M	36.10	27.75	29.12	30.51	31.46	29.51	34.17
On glass base	30cm	48.41	37.93	39.94	54.71	61.77	61.21	66.66
	1M	46.24	36.22	38.14	49.90	56.48	56.36	60.79
	2M	43.15	33.57	34.78	44.97	50.34	50.04	52.42
	3M	40.27	31.11	32.25	39.76	44.28	43.76	44.51
	5M	34.63	26.22	27.09	31.11	34.18	33.90	34.04
Average Gain(dBi)								
In free space	30cm	-3.54	-4.77	-4.51	-2.69	-2.46	-2.89	-1.71
	1M	-3.74	-4.97	-4.71	-3.09	-2.84	-3.24	-2.11
	2M	-4.04	-5.30	-5.11	-3.55	-3.34	-3.76	-2.75
	3M	-4.34	-5.63	-5.44	-4.08	-3.90	-4.34	-3.46
	5M	-5.01	-6.37	-6.20	-5.15	-5.02	-5.45	-4.63
On 2mm ABS base	30cm	-3.08	-3.98	-3.67	-2.72	-2.47	-2.76	-1.75
	1M	-3.28	-4.18	-3.87	-3.12	-2.86	-3.11	-2.15
	2M	-3.58	-4.51	-4.27	-3.57	-3.36	-3.63	-2.79
	3M	-3.88	-4.83	-4.60	-4.11	-3.91	-4.21	-3.50
	5M	-4.55	-5.58	-5.36	-5.17	-5.04	-5.32	-4.67
On glass base	30cm	-3.31	-4.22	-3.99	-2.64	-2.11	-2.14	-1.77
	1M	-3.51	-4.42	-4.19	-3.04	-2.50	-2.50	-2.17
	2M	-3.81	-4.75	-4.59	-3.49	-3.00	-3.02	-2.82
	3M	-4.11	-5.08	-4.92	-4.03	-3.55	-3.60	-3.52
	5M	-4.77	-5.82	-5.67	-5.09	-4.67	-4.71	-4.69
Peak Gain(dBi)								
In free space	30cm	3.75	1.34	1.45	4.53	3.17	3.32	4.17
	1M	3.55	1.14	1.25	4.13	2.77	2.92	3.77
	2M	3.25	0.74	0.85	3.73	2.27	2.42	3.07
	3M	2.95	0.44	0.54	3.23	1.77	1.82	2.37
	5M	2.35	-0.31	-0.25	2.13	1.77	0.72	1.17
On 2mm ABS base	30cm	3.78	2.32	2.39	3.45	4.37	4.37	5.63
	1M	3.58	2.12	2.19	3.05	3.97	3.97	5.23
	2M	3.28	1.74	1.79	2.55	3.47	3.47	4.53
	3M	2.98	1.42	1.49	2.05	2.87	2.87	3.73
	5M	2.38	0.72	0.72	0.95	1.77	1.77	2.63
On glass base	30cm	3.35	1.54	2.10	3.15	3.86	3.86	3.75
	1M	3.15	1.34	1.90	2.75	3.46	3.46	3.35
	2M	2.85	1.03	1.50	2.35	2.96	2.96	2.71
	3M	2.55	0.64	1.10	1.85	2.36	2.36	2.01
	5M	1.95	0.64	0.40	0.75	1.26	1.26	0.91

4G/3G/2G	
Envelope Correlation Coefficient	All Bands < 0.3
Impedance	50Ω
Polarization	Linear
Return Loss	< -6dB
Input Power	5Watts

GPS-GLONASS-BeiDou	
Center Frequency	GPS: 1575.42±1.023MHz GLONASS: 1602±5MHz BeiDou: 1561.098±2.046MHz
Passive Antenna Efficiency (without cable loss)	GPS:65.86 GLONASS:75.07 BeiDou:62.2
Passive Antenna Average gain(without cable loss)	GPS:-1.81 GLONASS:-1.25 BeiDou:-2.03
Passive Antenna Peak gain(without cable loss)	GPS:3.03 GLONASS:4.22 BeiDou:1.7
VSWR	< 3:1
Impedance	50Ω
Axial Ratio	GPS: 12.48 GLONASS: 20.6 BeiDou: 8.97
Polarization	RHCP

LNA and Filter Electrical Properties				
Center Frequency	GPS: 1575.42±1.023MHz GLONASS: 1602±5MHz BeiDou: 1561.098±2.046MHz			
Output Impedance	50Ω			
VSWR	< 2:1			
Return Loss	< -10dB			
LNA Gain, Current Draw, and Noise Figure @ GPS	Voltage	LNA Gain(Typ)	Current Draw(Typ)	Noise Figure(Typ)
	Min 1.8V	25.34	5mA	2.30
	Typ 3.0V	28.63	10mA	2.69
	Max 5.5V	32.79	23mA	2.98

Total specification (Through antenna, SAW Filter and LNA)			
Frequency	1561.098±2.046 MHz	1575.42±1.023 MHz	1602±5 MHz
Gain@3V(dB)	28.06	28.63	27.84
Output Impedance	50Ω		

MECHANICAL	
Antenna Dimensions	139.27*76.27*14mm
Housing	ABS
Waterproof	IP67
Connector	SMA(M) ST
Cable type	LTE: CFD-200 GPS/GLONASS/BeiDou: RG-174
Cable length	2000mm
Weight	280g
ENVIRONMENTAL	
Operation Temperature	-40°C to 85°C
Storage Temperature	-40°C to 85°C
Humidity	Non-condensing 65°C 95% RH

3. Antenna Characteristics

3.1. LTE Characteristics

3.1.1. Test Setup



In free space

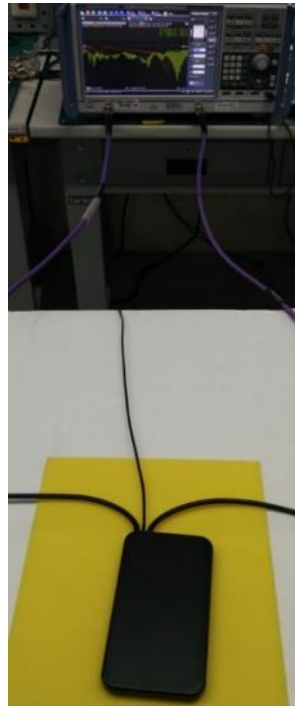

On 2mm ABS

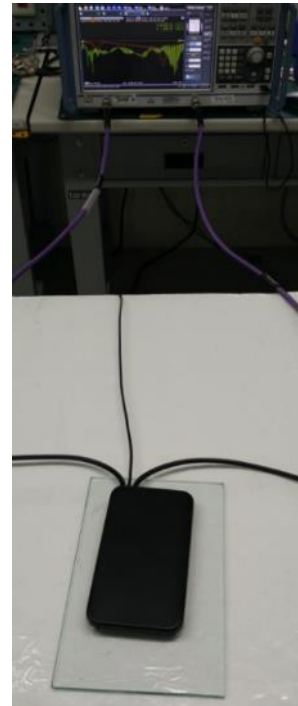

On glass

3.1.2. Return Loss (MIMO 1)

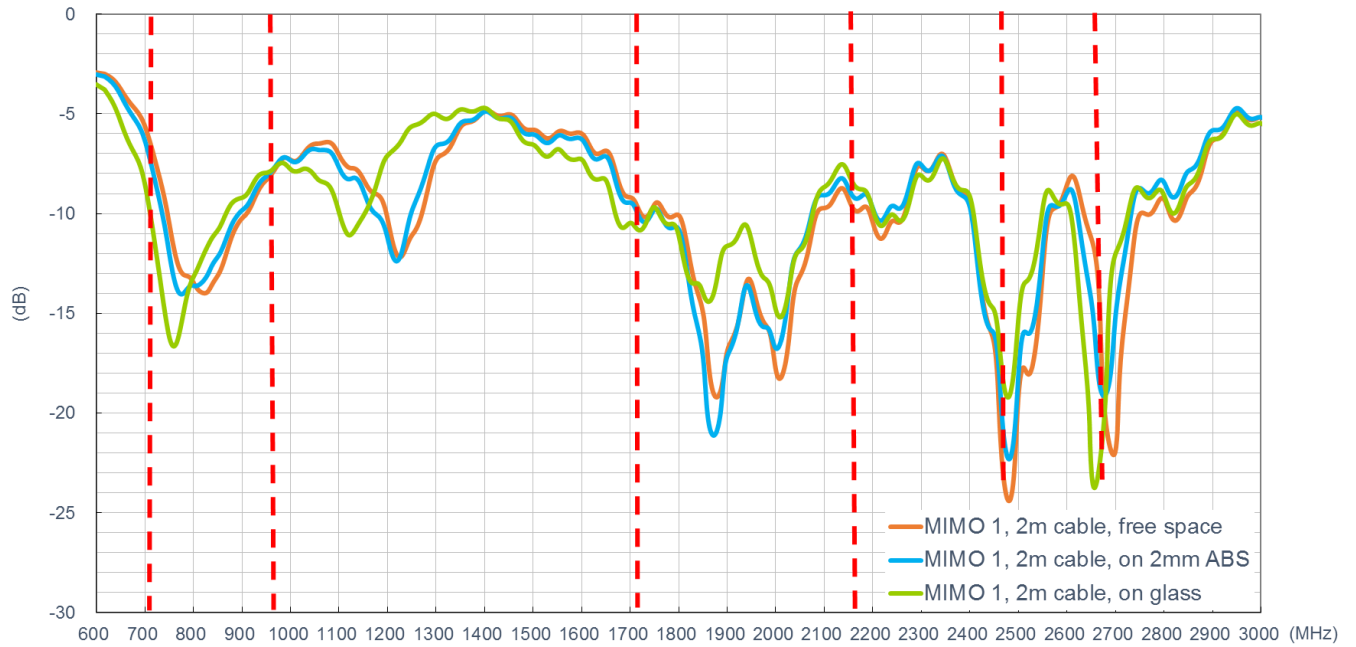

3.1.3. Return Loss (MIMO 2)

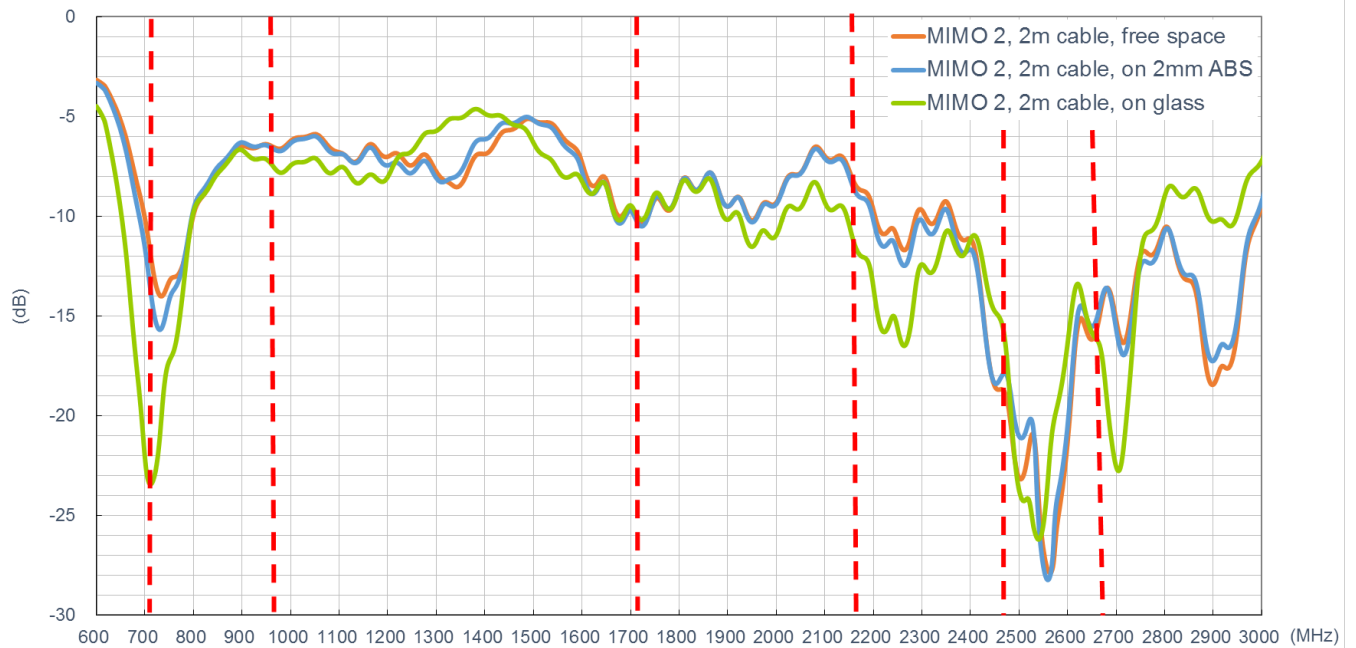

3.1.4. Isolation

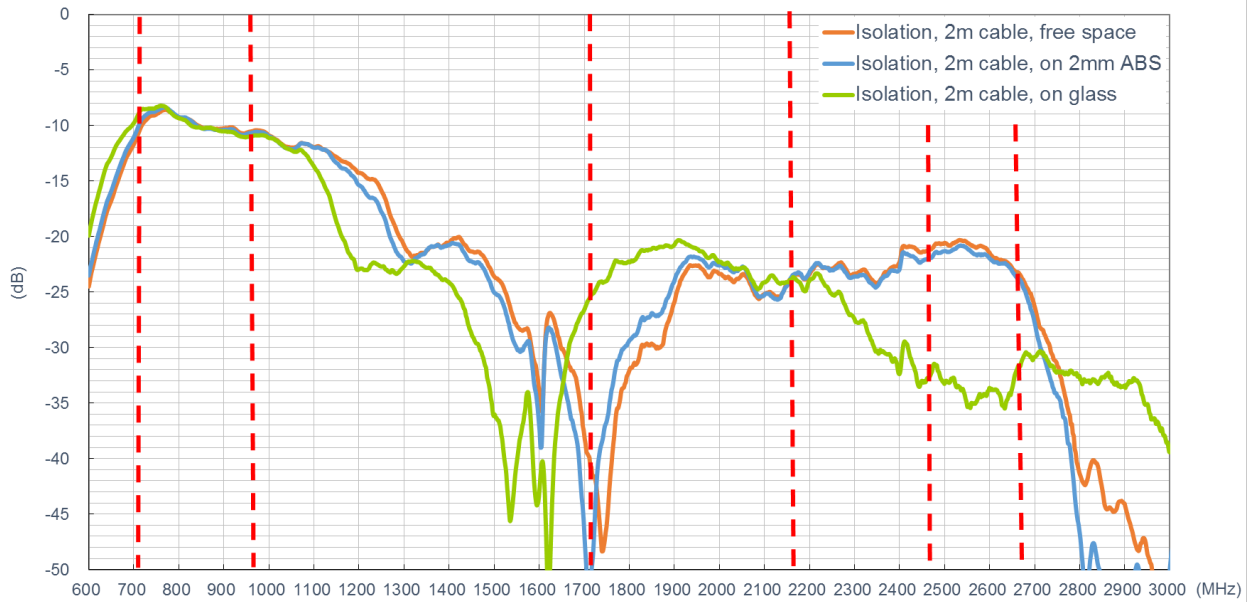

3.1.5. Efficiency (MIMO 1)

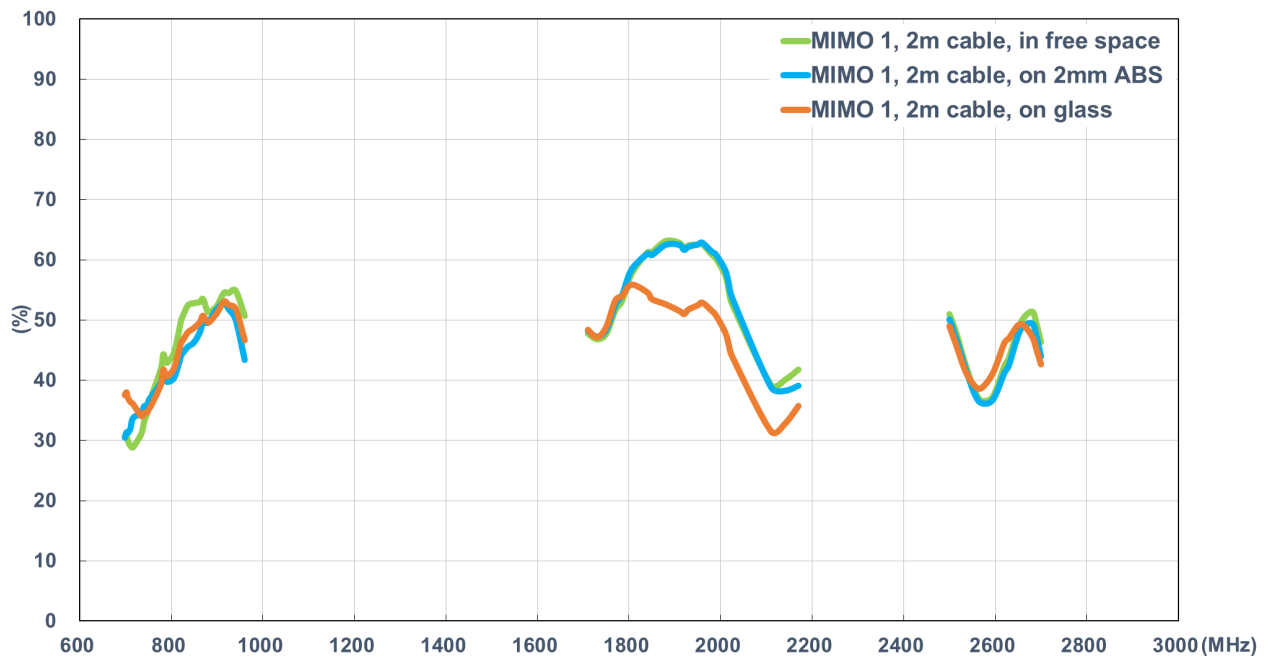

3.1.6. Efficiency (MIMO 2)

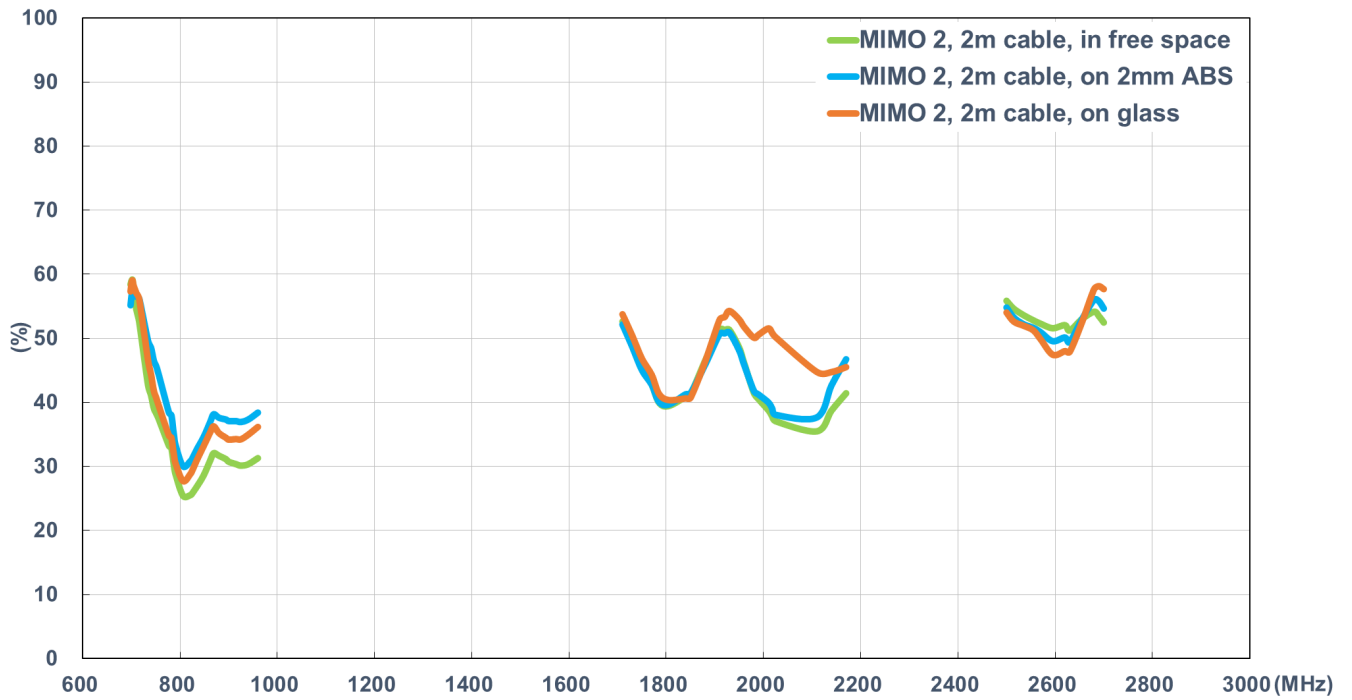

3.1.7. Average Gain (MIMO 1)

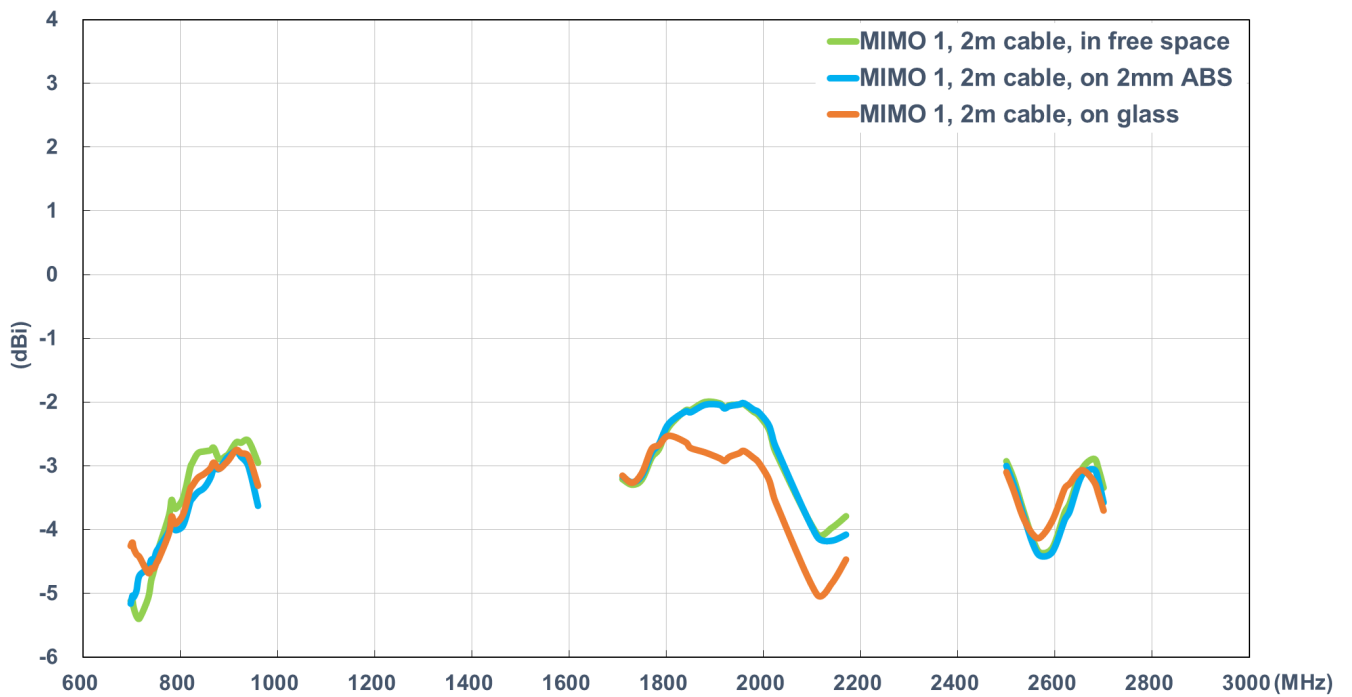

3.1.8. Average Gain (MIMO 2)

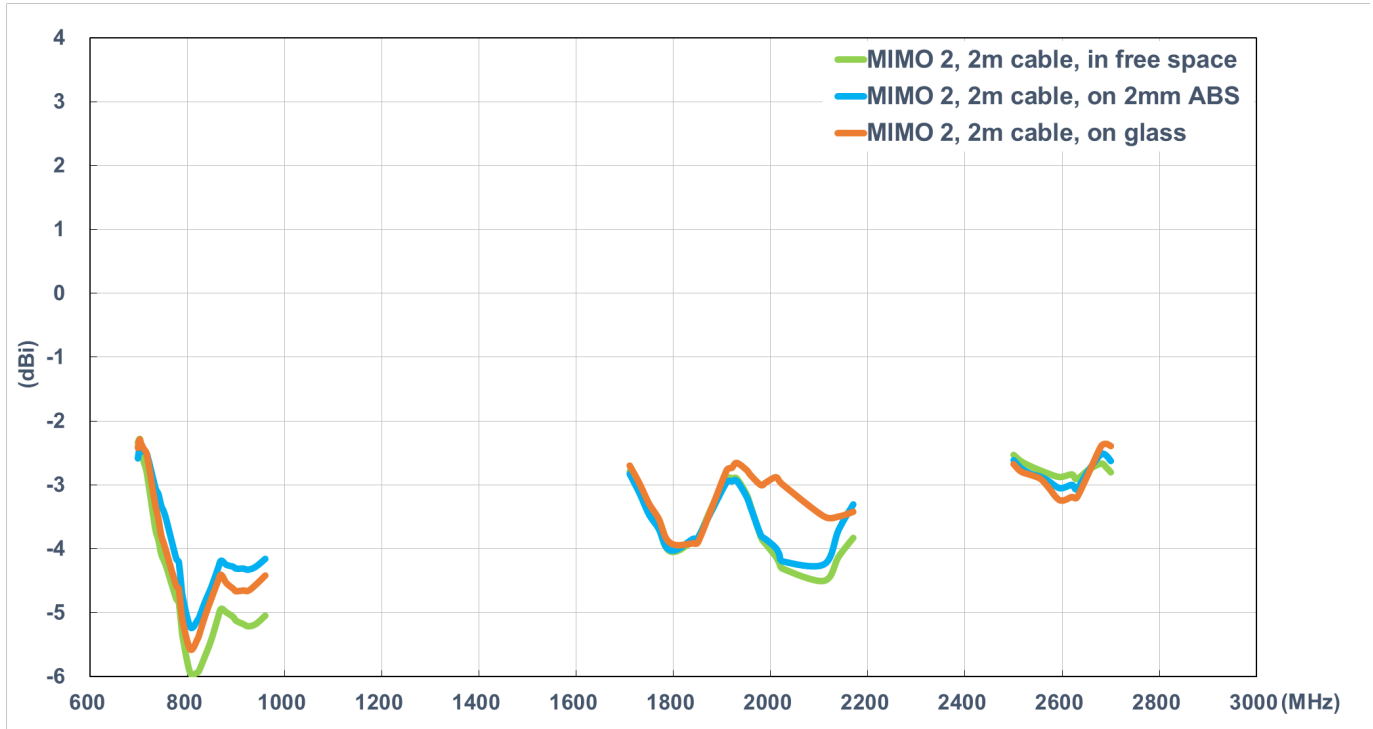

3.1.9. Peak Gain (MIMO 1)

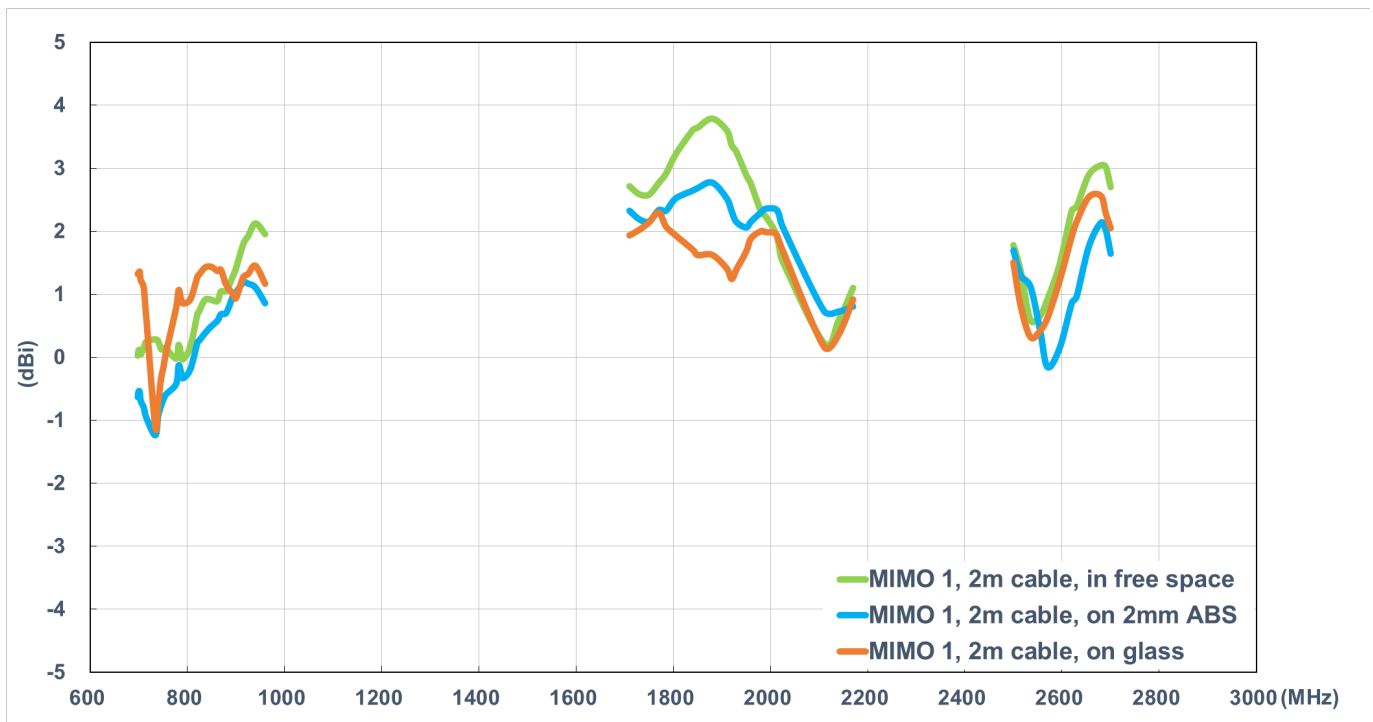

3.1.10. Peak Gain (MIMO 2)

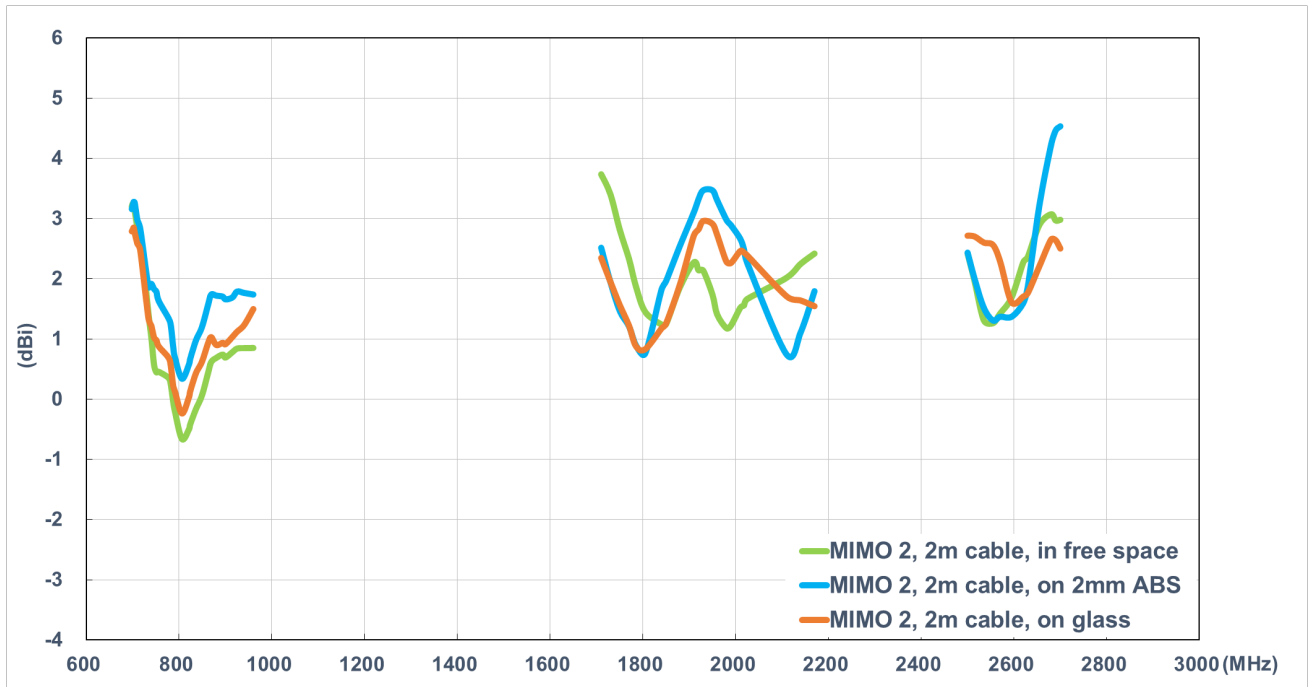

3.1.11. Envelope Correlation Coefficient (ECC)

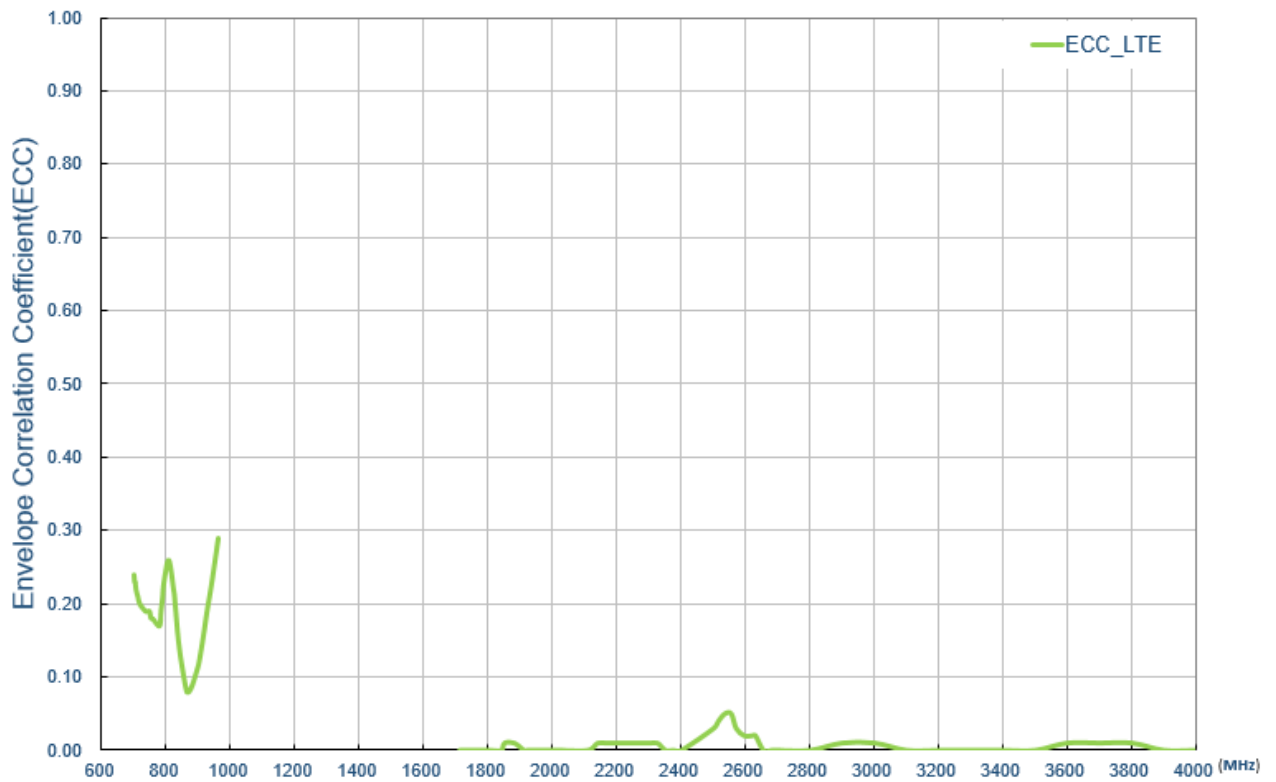

3.2. GPS/GLONASS/BeiDou Characteristics

3.2.1. Return Loss

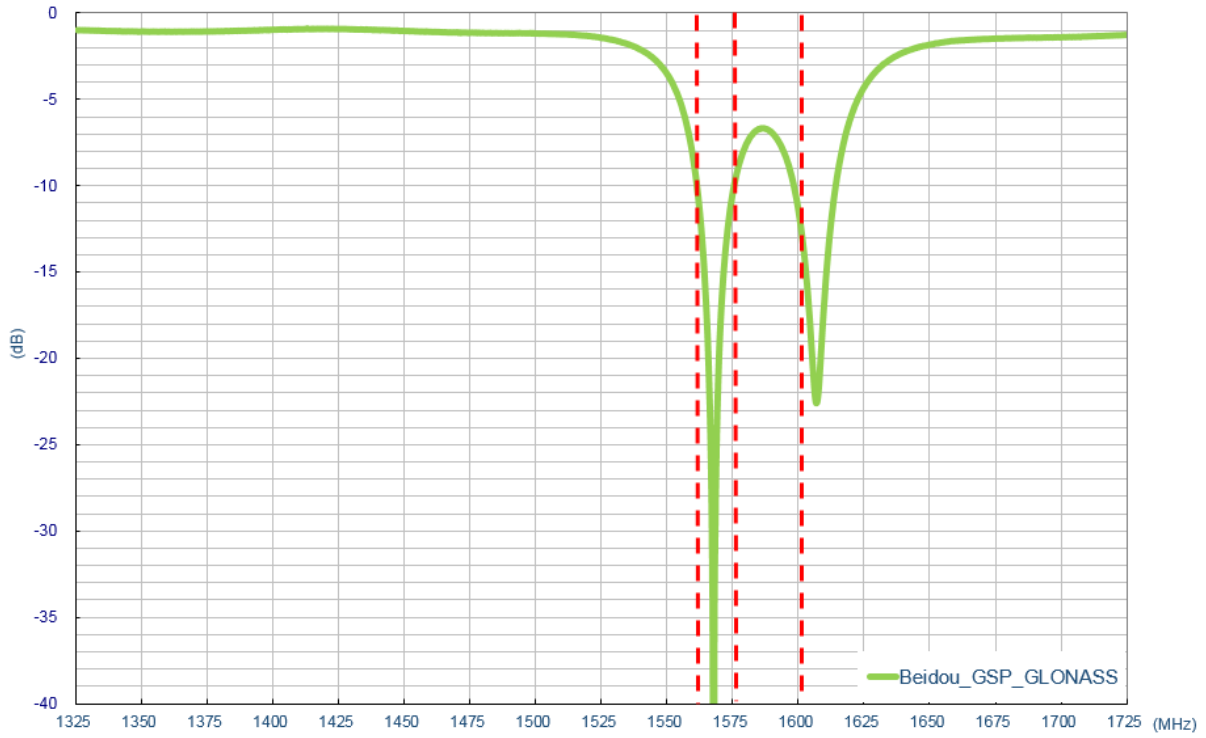

3.2.2. Smith Chart

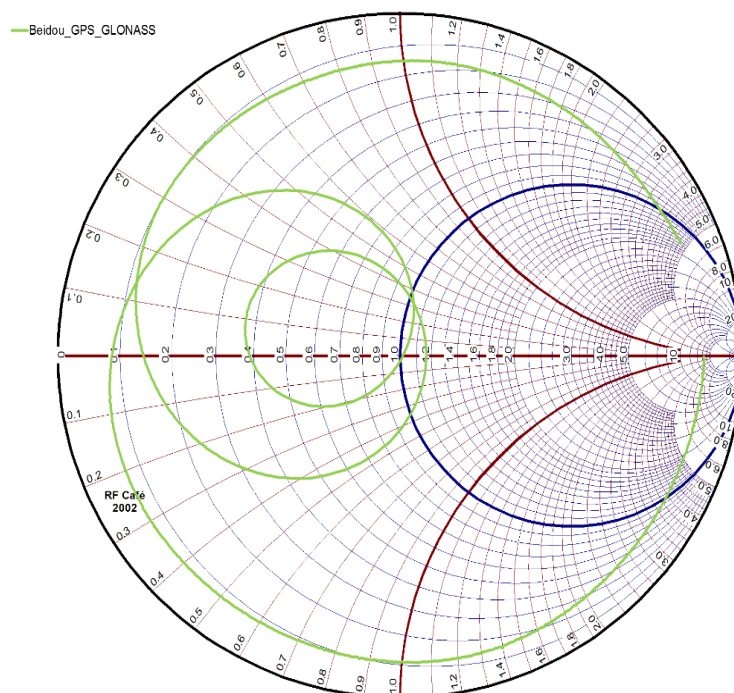

3.2.3. Efficiency

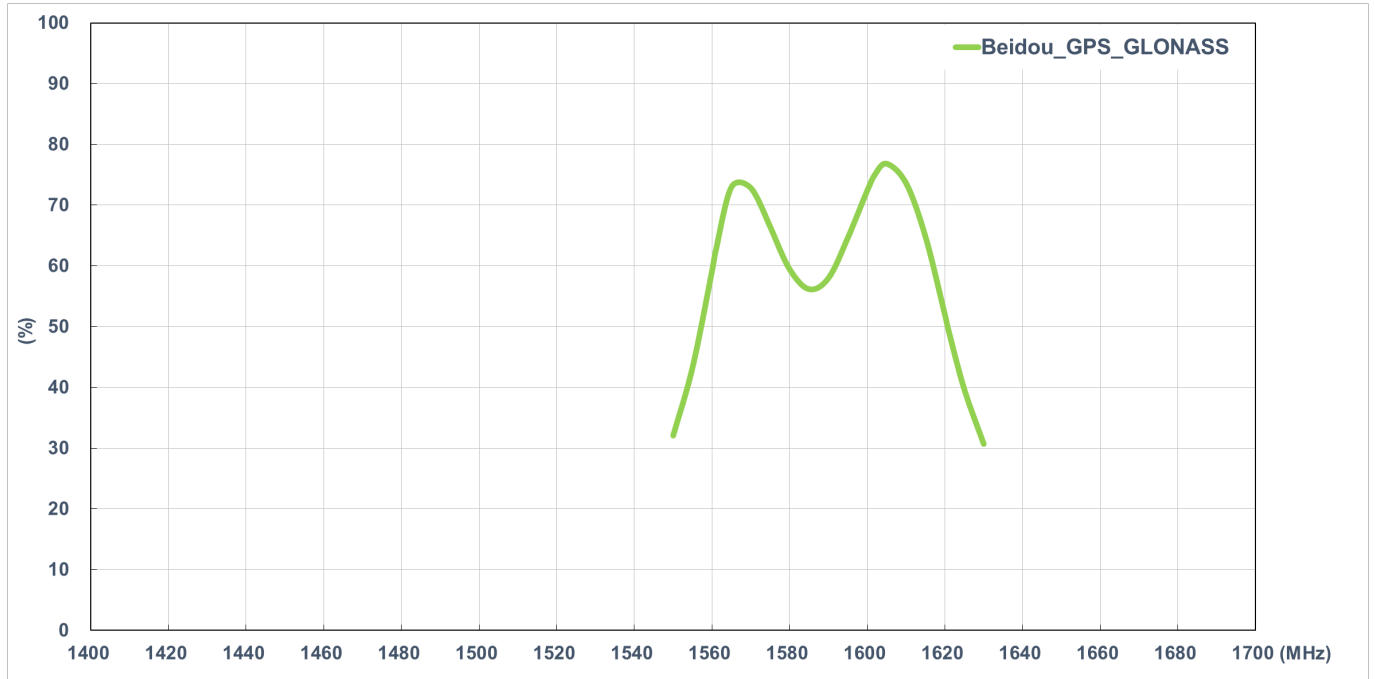

3.2.4. Average Gain

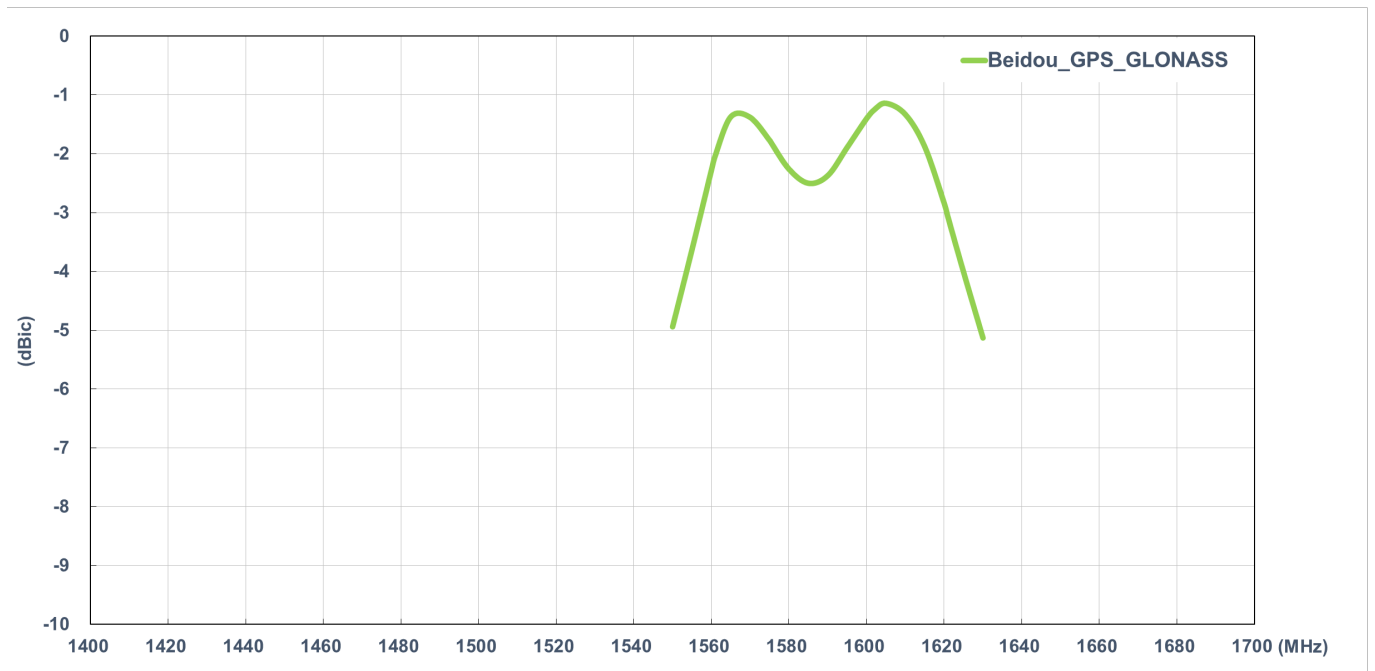

3.2.5. Peak Gain

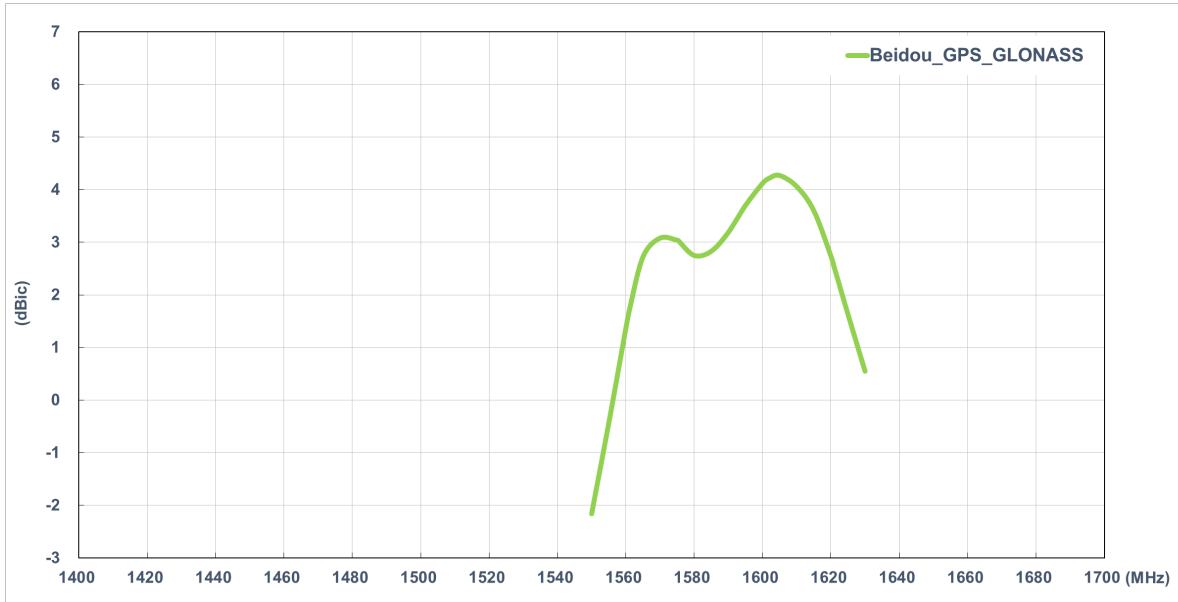

3.2.6. Axial Ratio

3.2.6.1. BeiDou

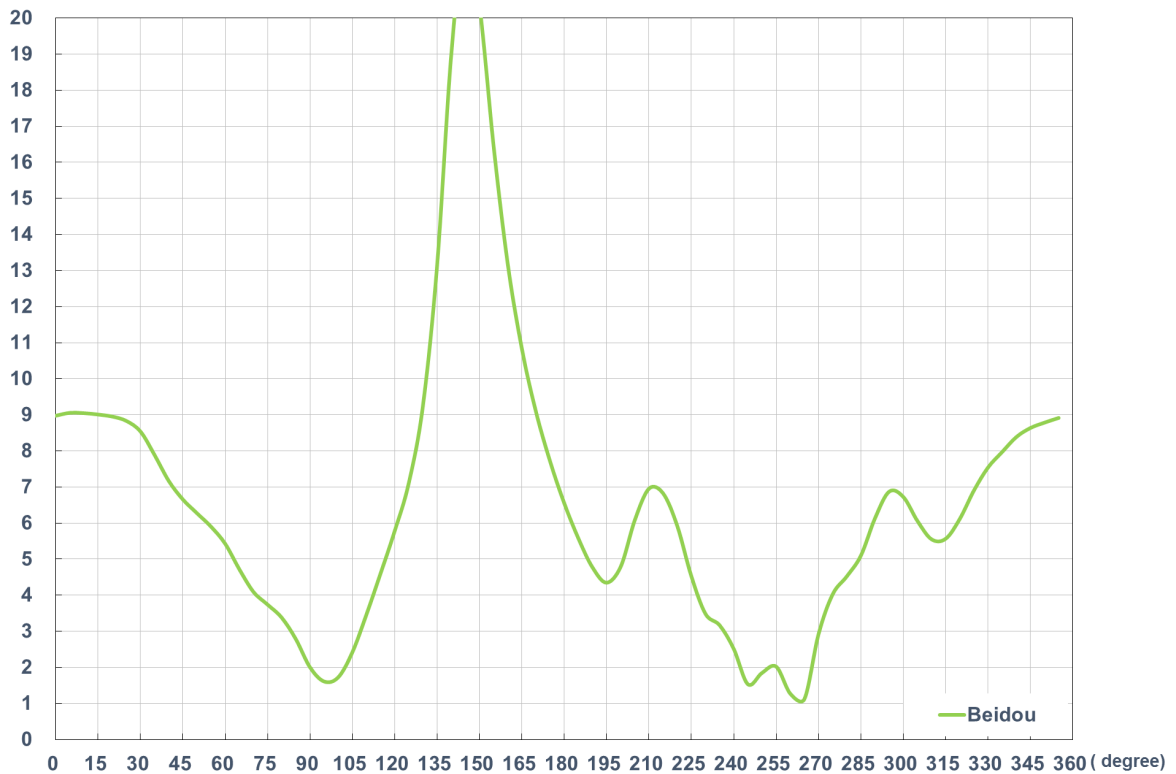

3.2.6.2. GPS

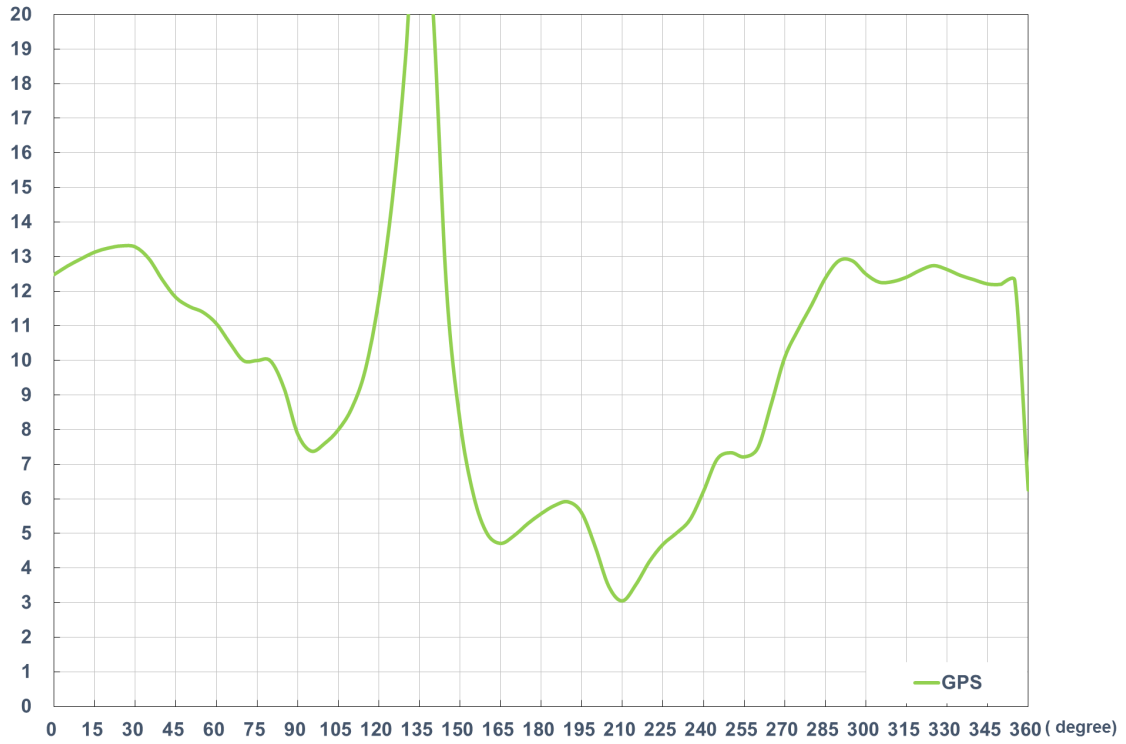

3.2.6.3. GLONASS

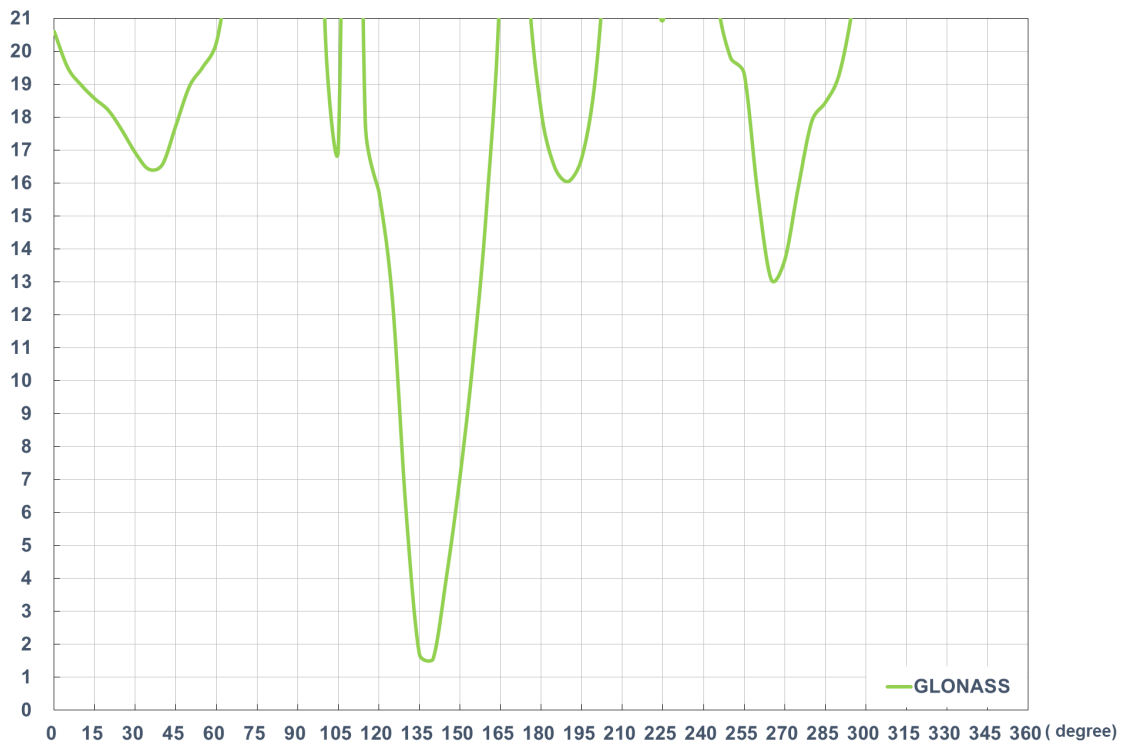

3.2.7. LNA Gain and Noise Figure

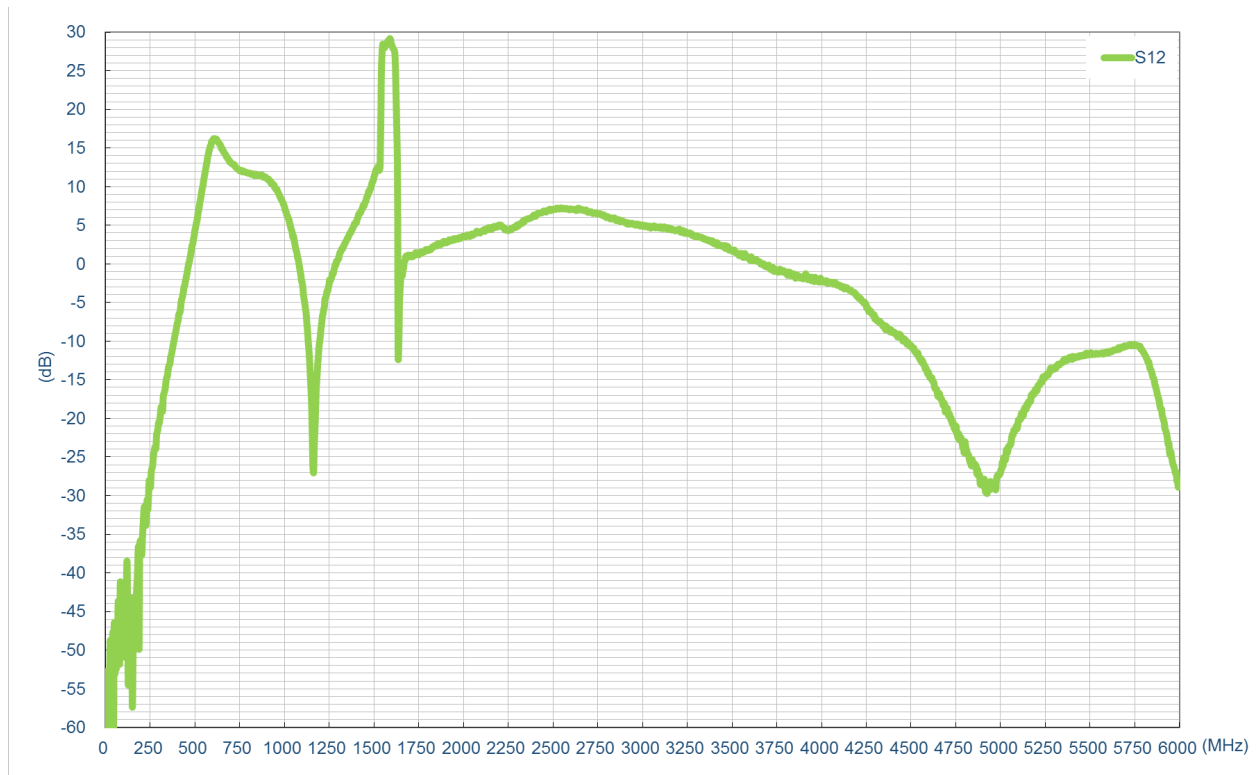

LNA Gain@3.0V

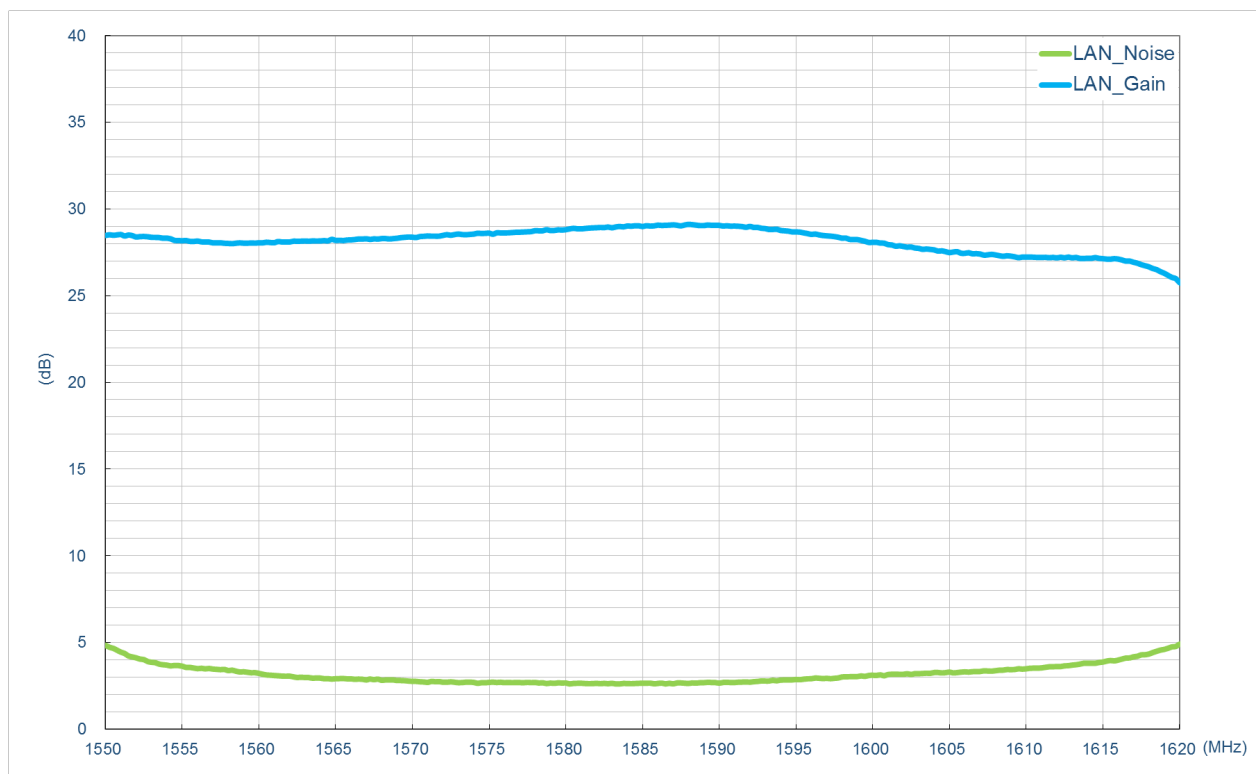

LNA Noise @3.0V

3.3. 2D Radiation Pattern

3.3.1. Test Setup

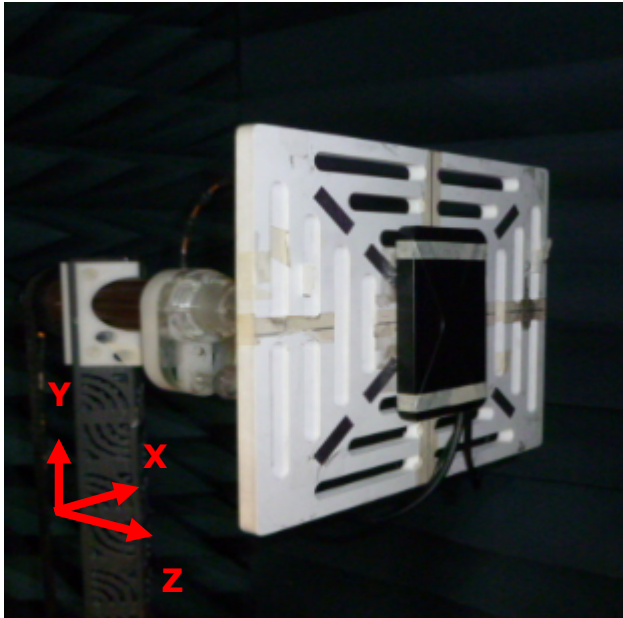

In free space

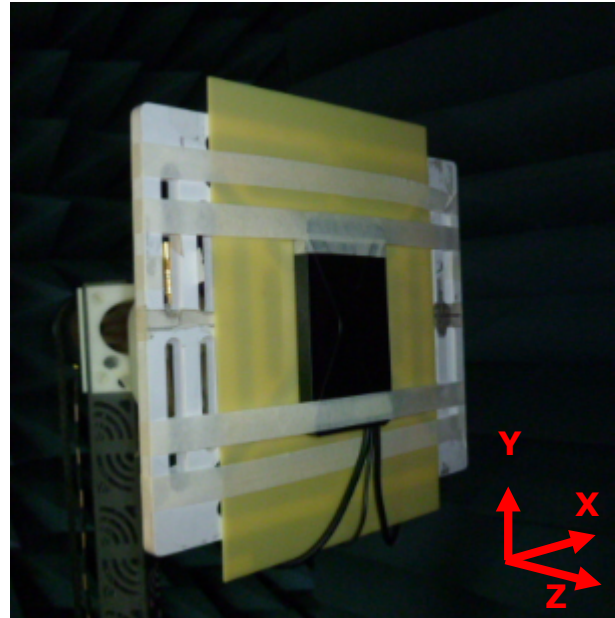

On 2mm ABS

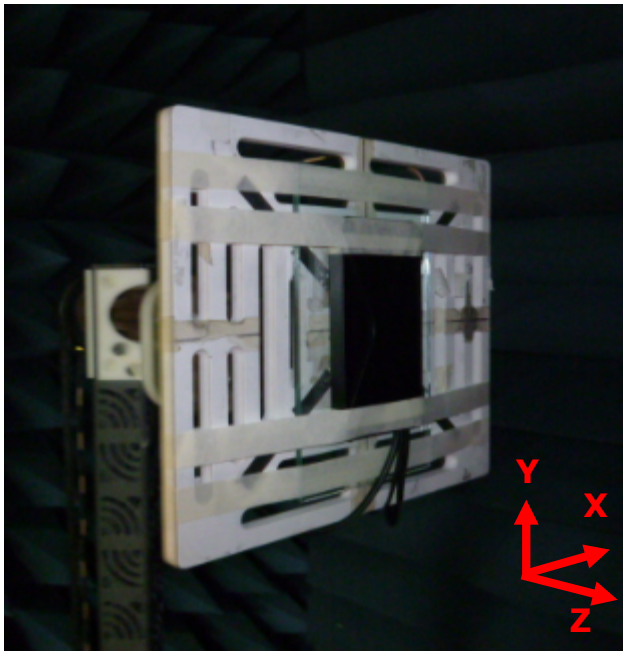

On glass base

3.3.2. LTE with 2M cable length in free space (MIMO 1)

XY Plane

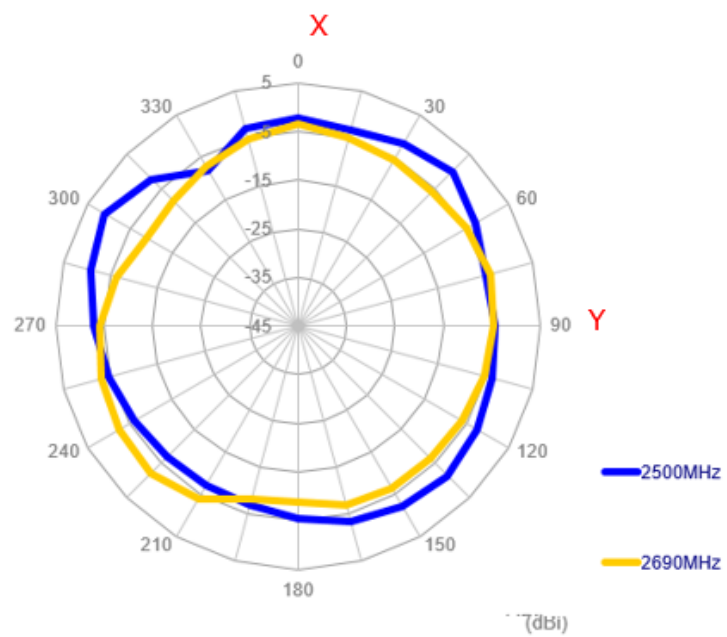
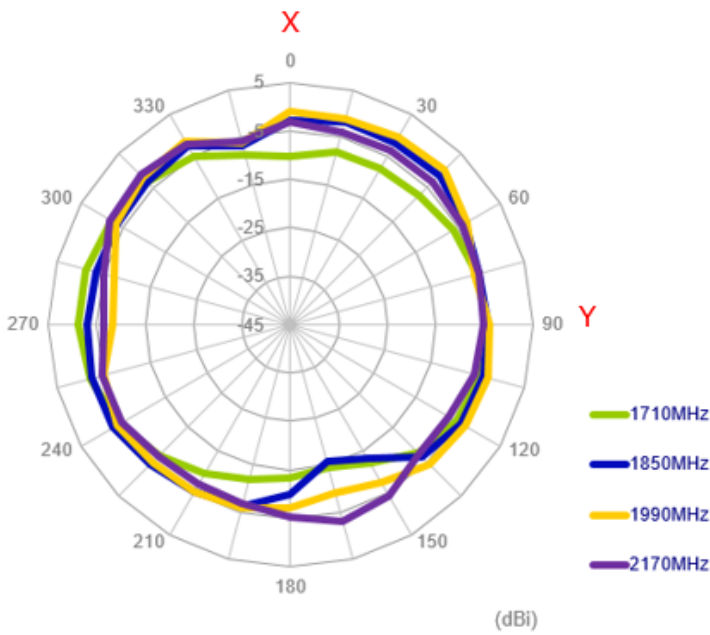
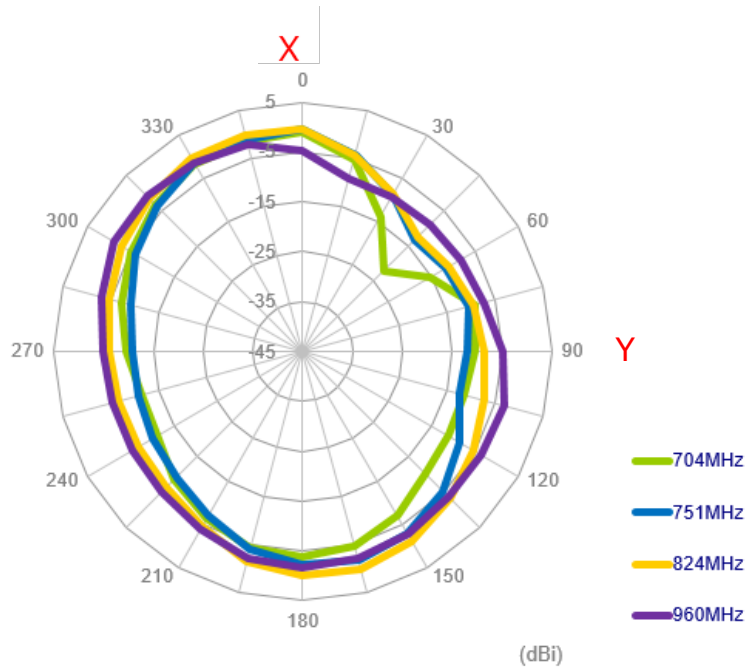

XZ Plane

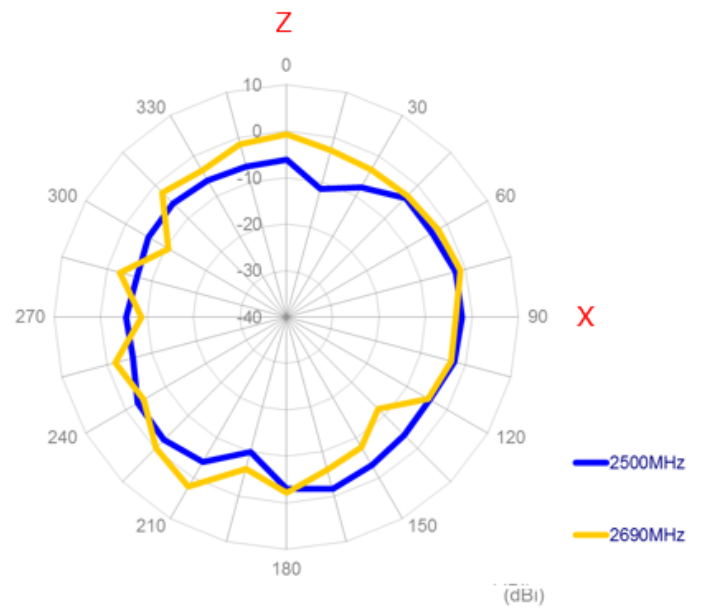
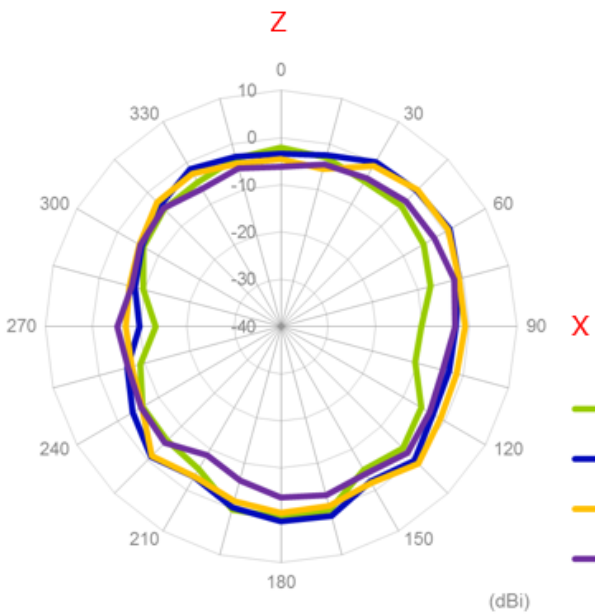
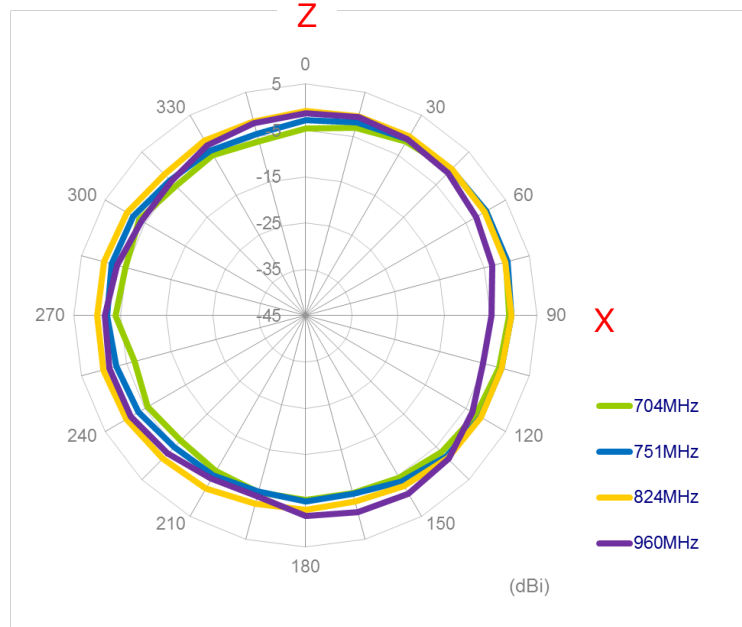



YZ Plane

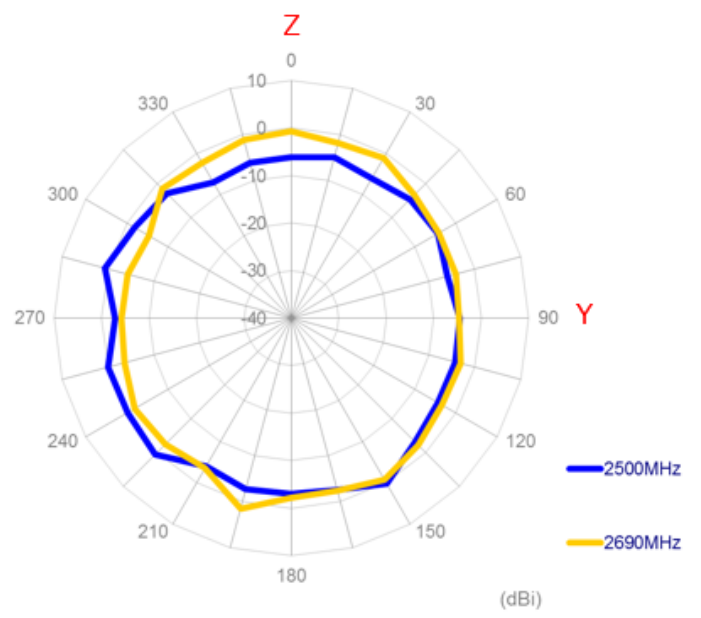
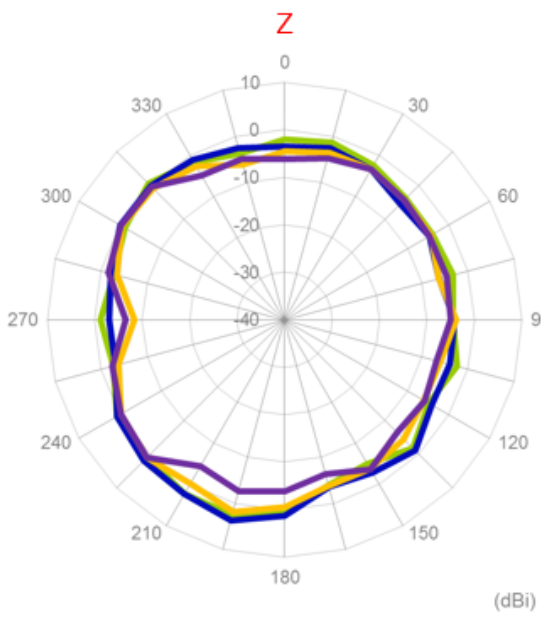
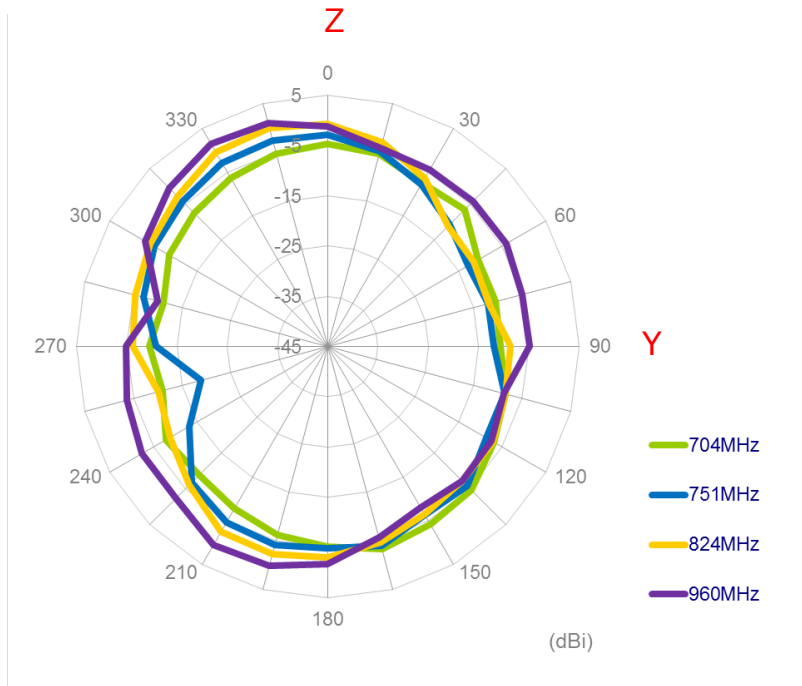

3.3.3. LTE with 2M cable length in free space (MIMO 2)

XY Plane

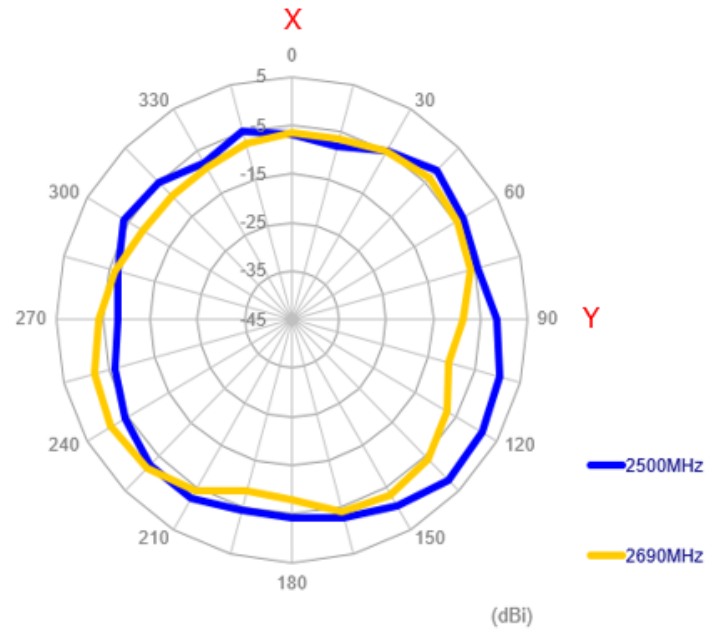
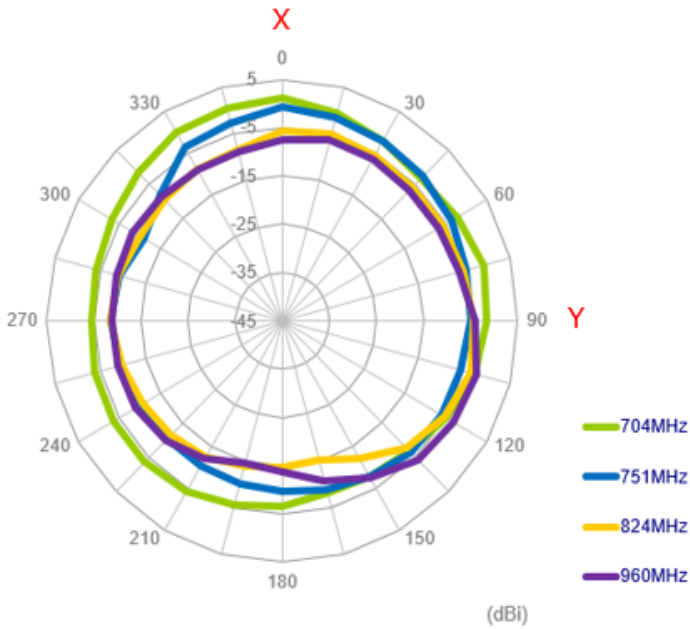
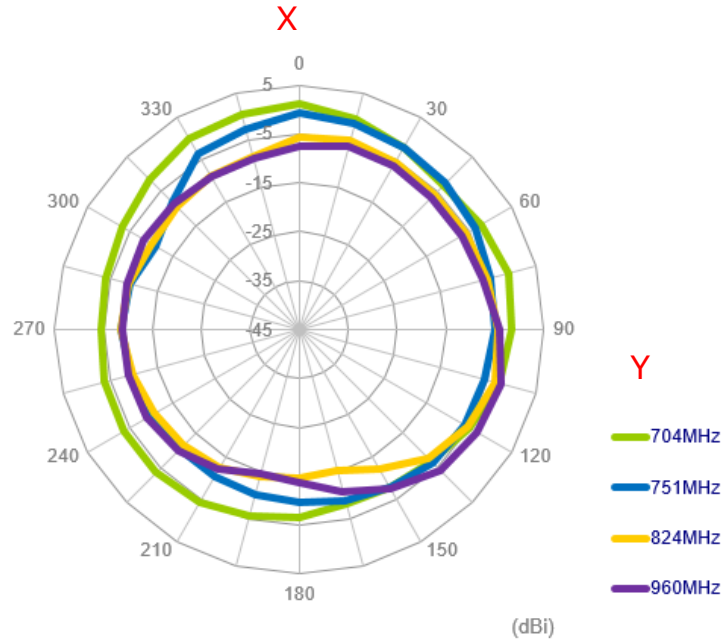

XZ Plane

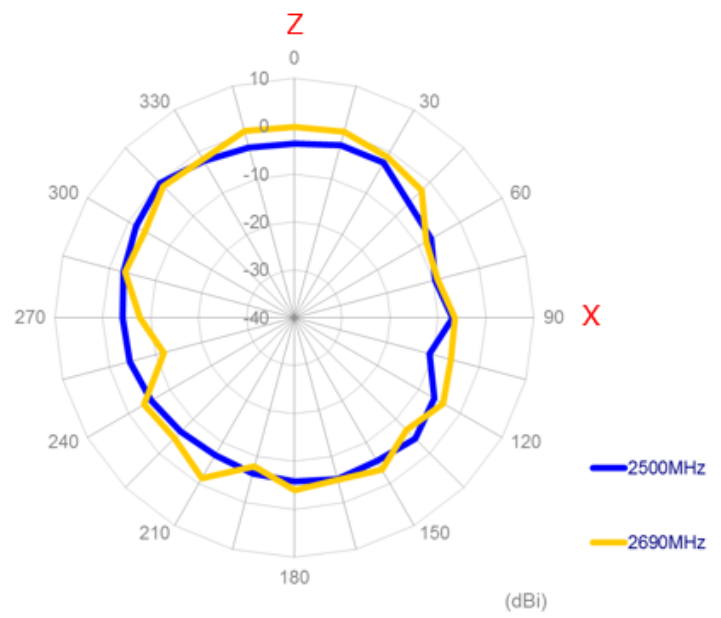
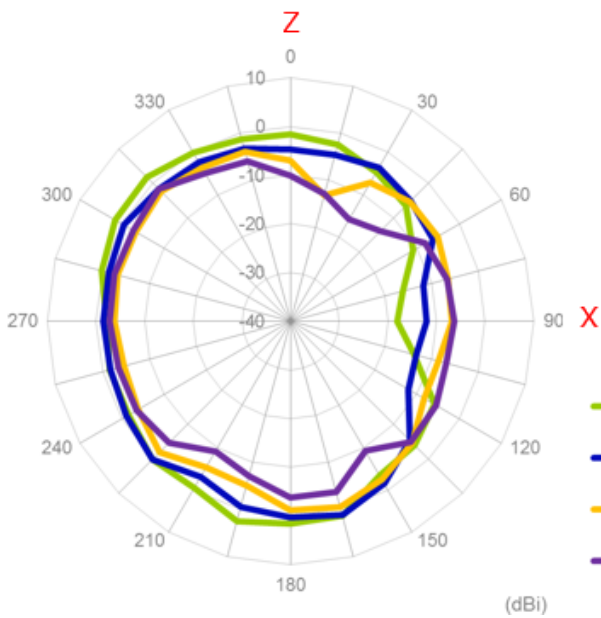
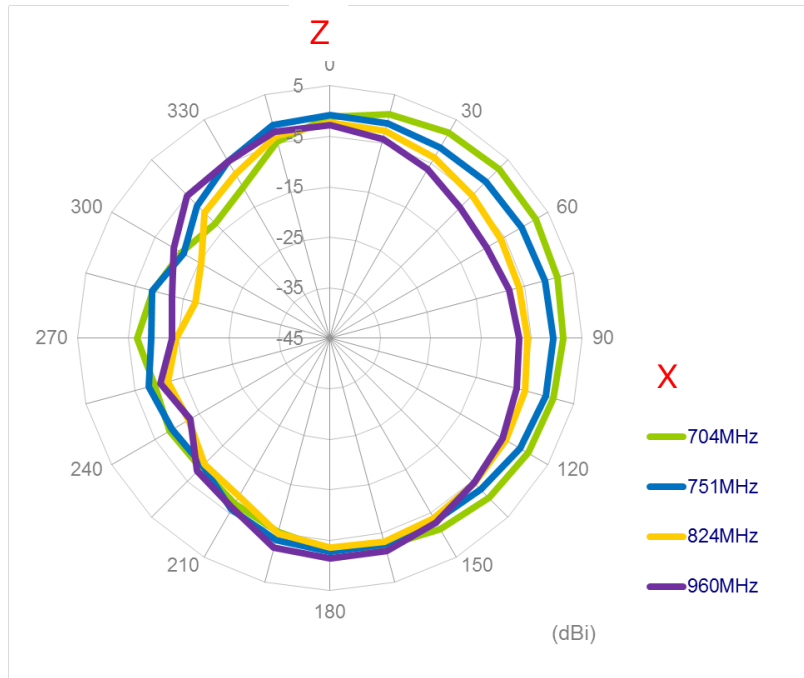



YZ Plane

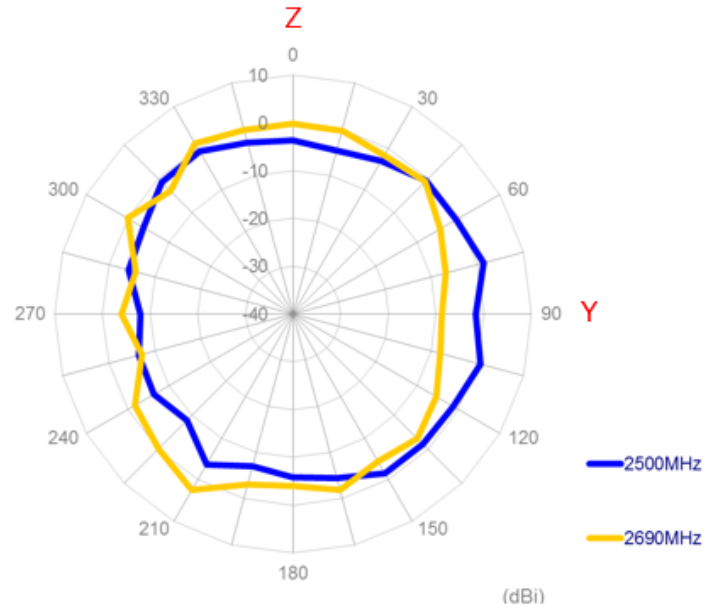
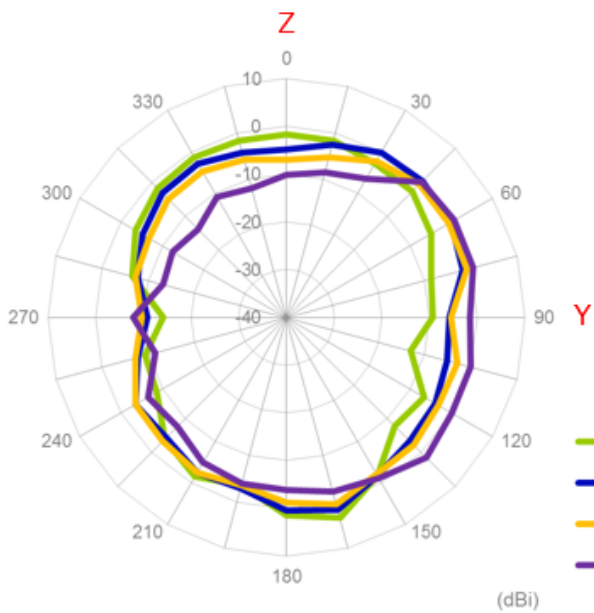
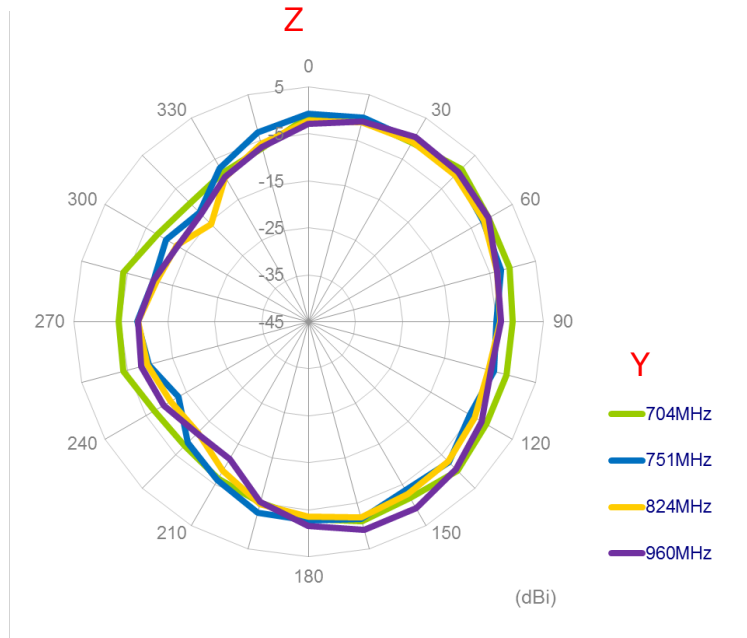

3.3.4. LTE with 2M cable length on the 2mm ABS (MIMO 1)

XY Plane

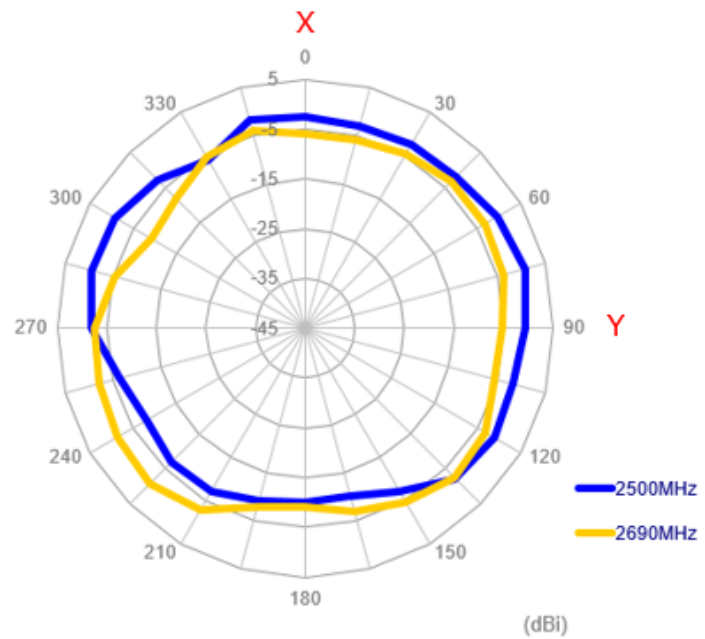
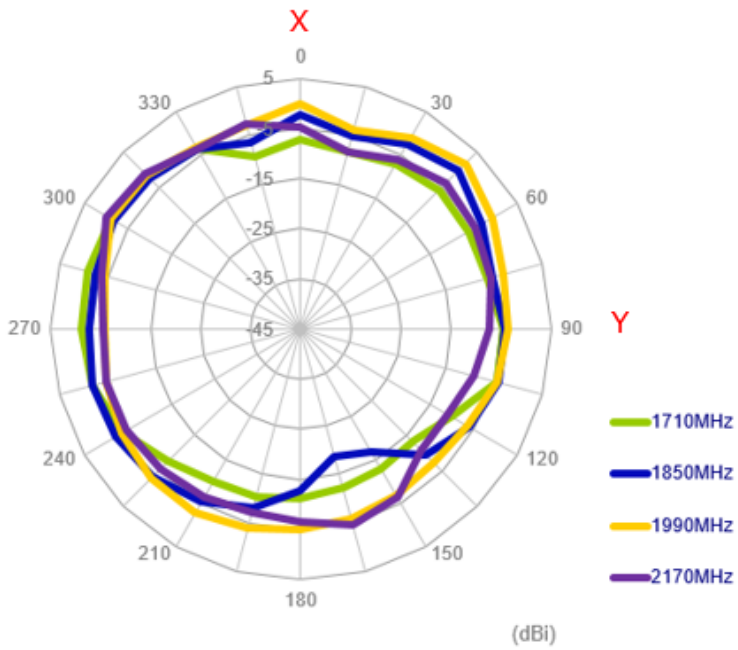
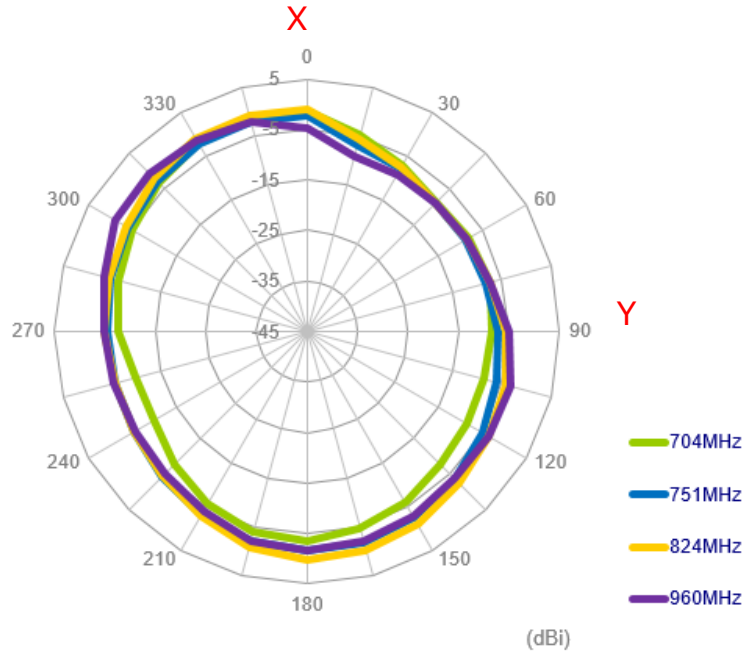

XZ Plane

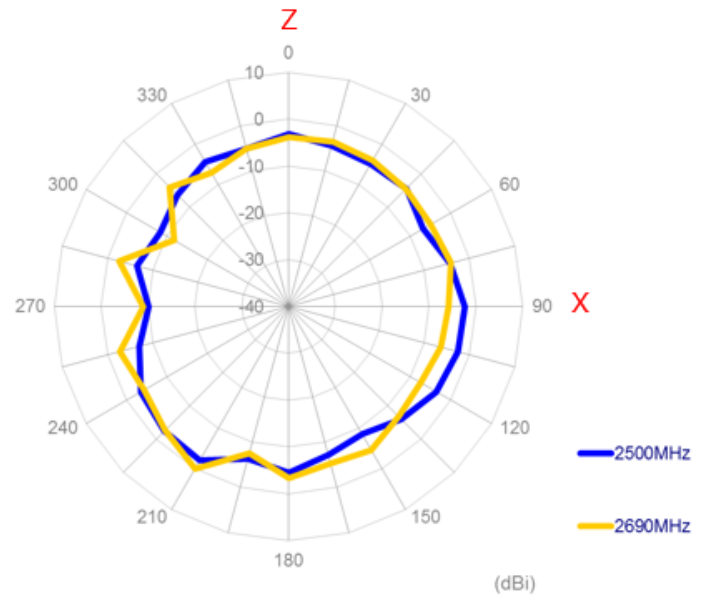
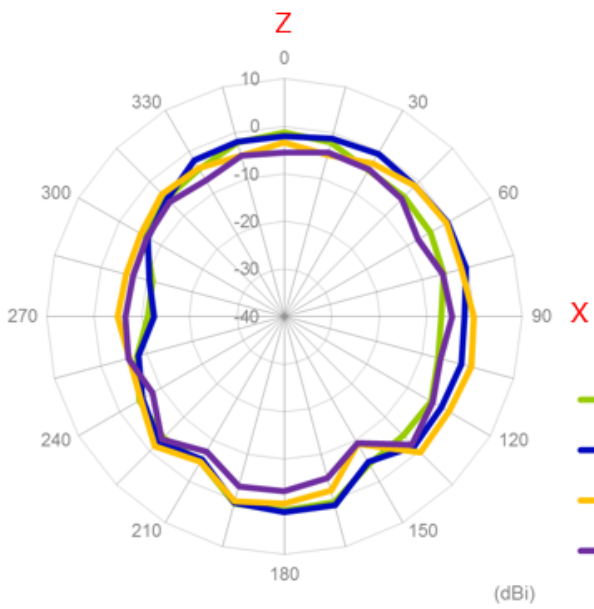
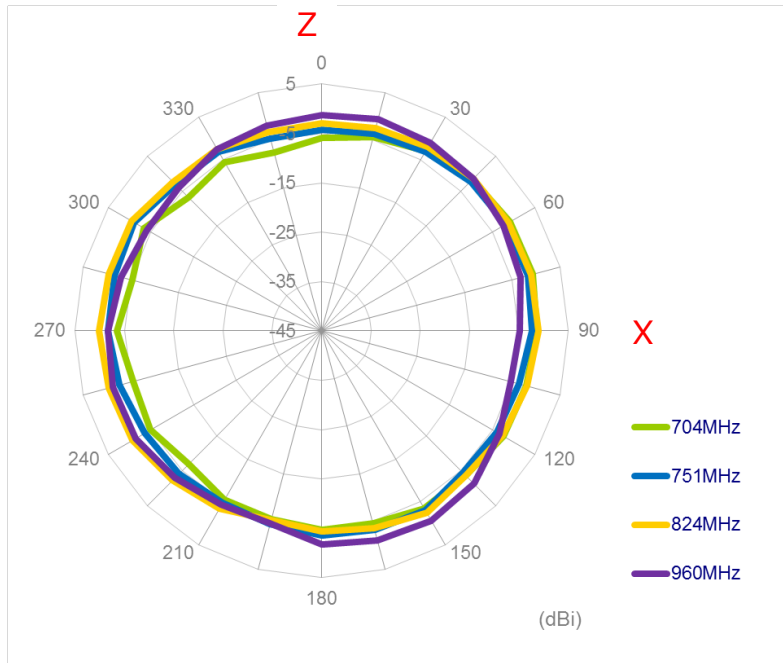



YZ Plane

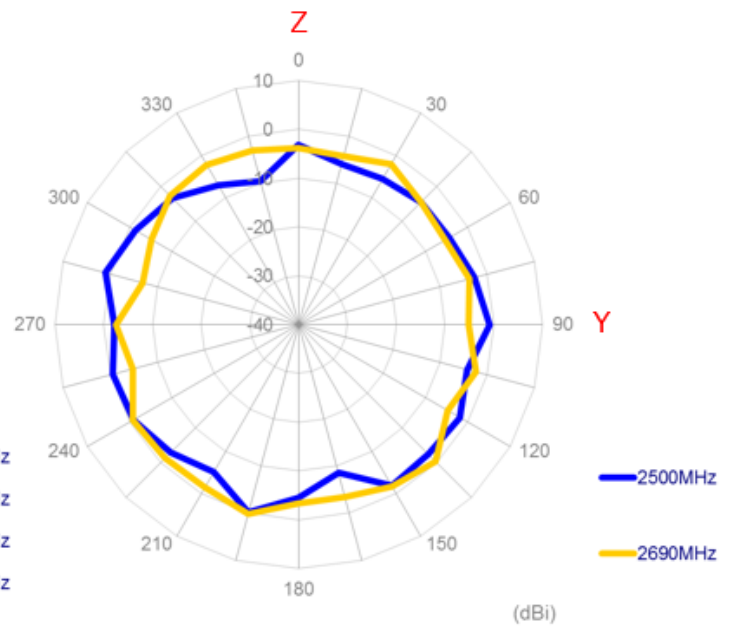
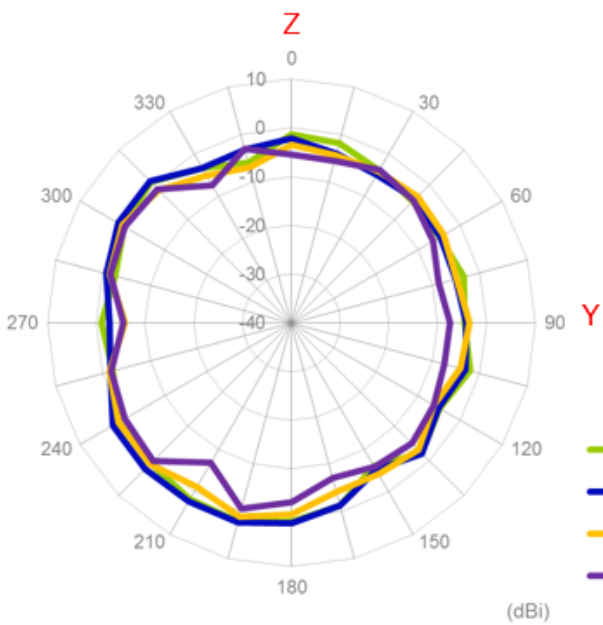
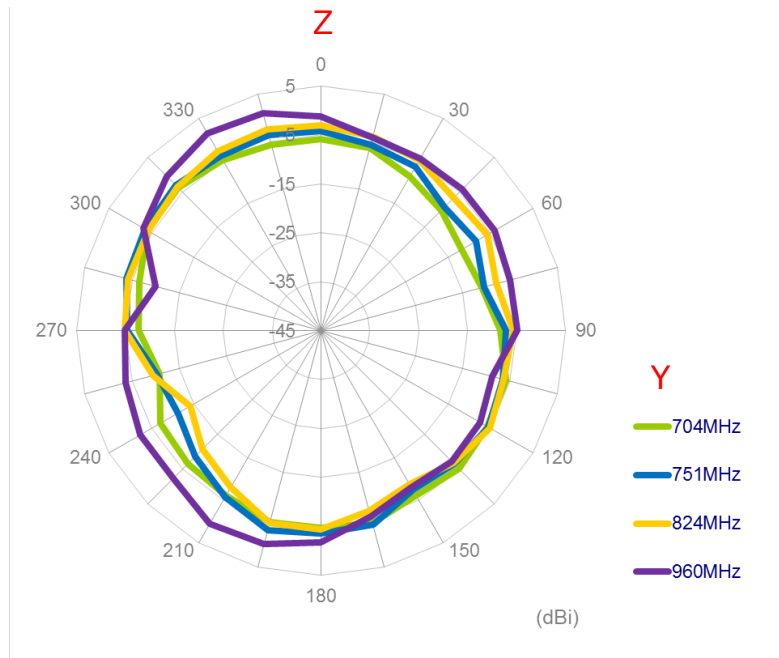

3.3.5. LTE with 2M cable length on the 2mm ABS (MIMO 2)

XY Plane

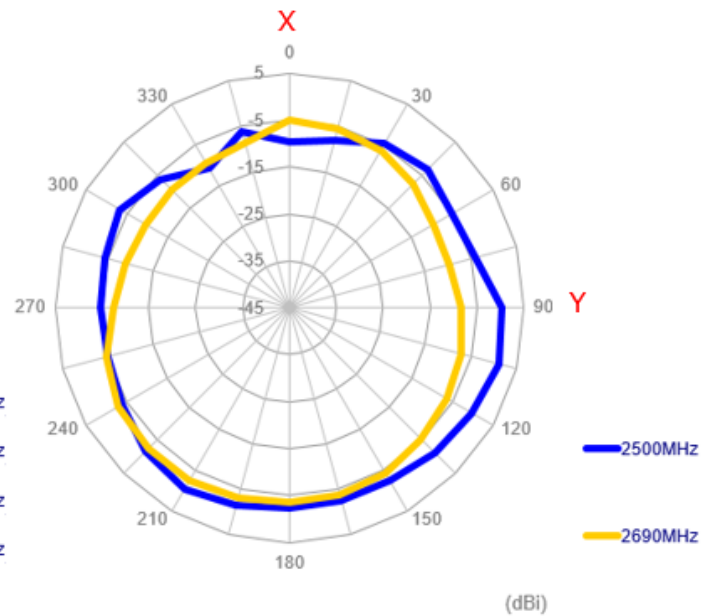
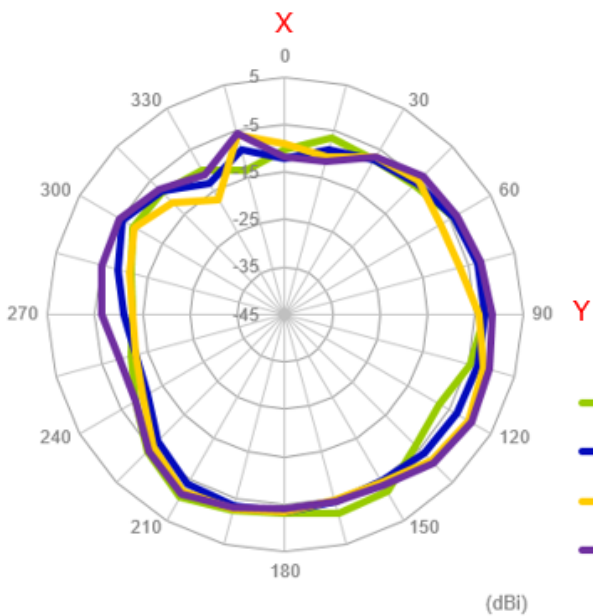
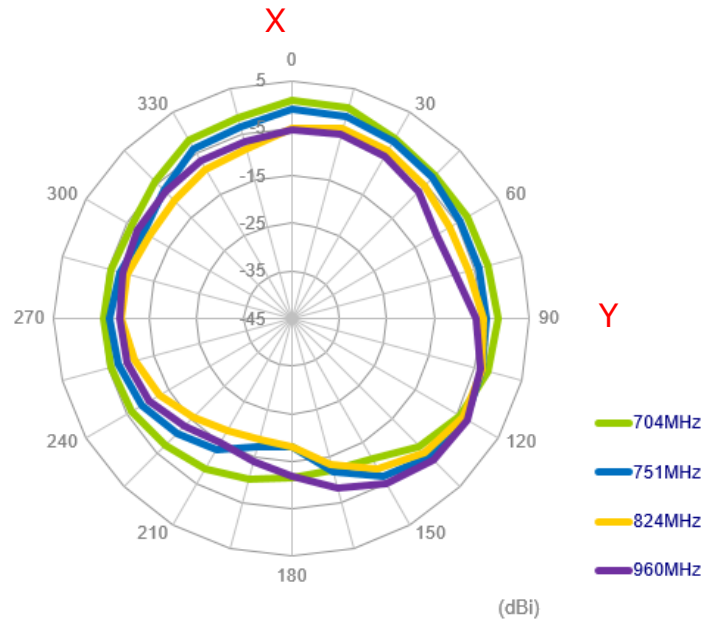

XZ Plane

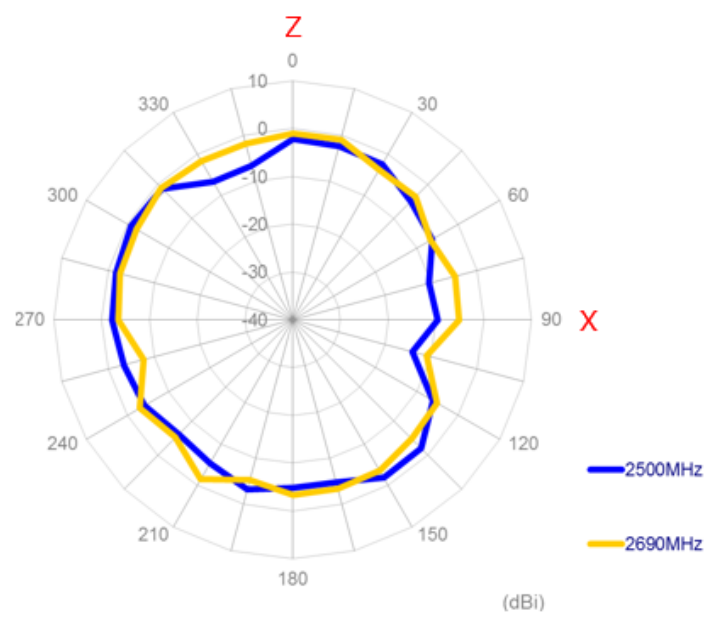
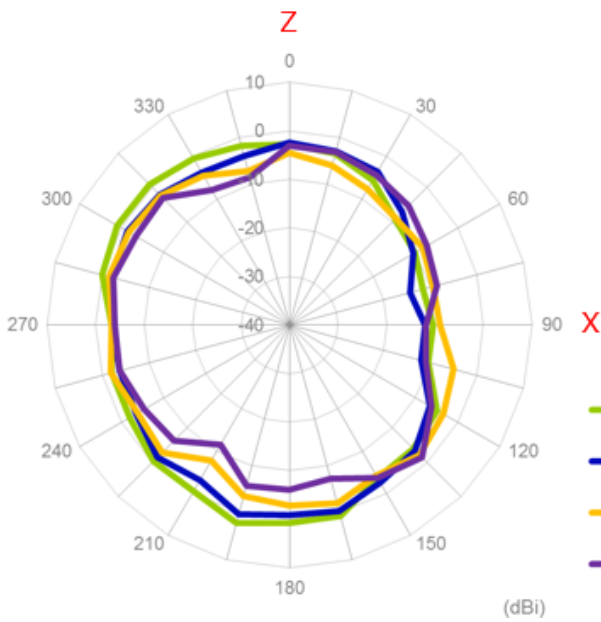
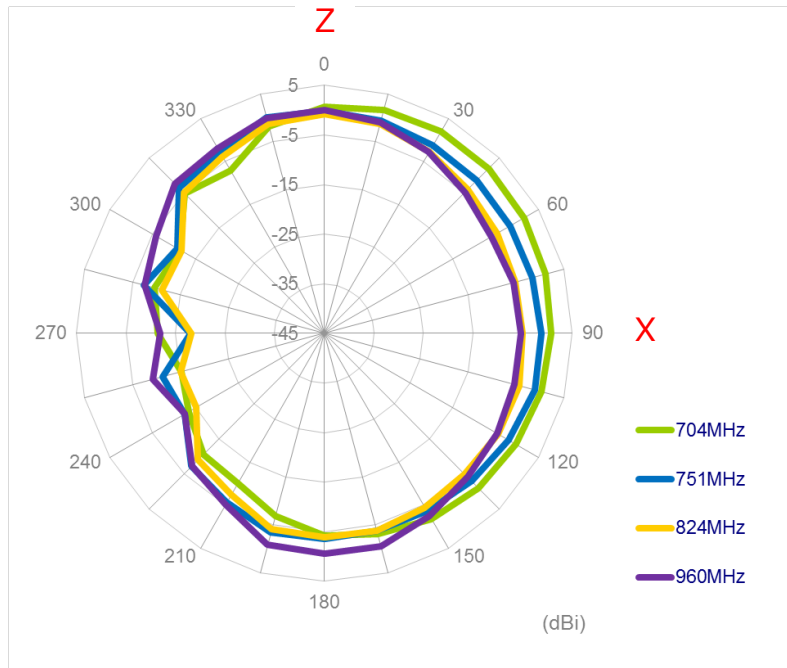



YZ Plane

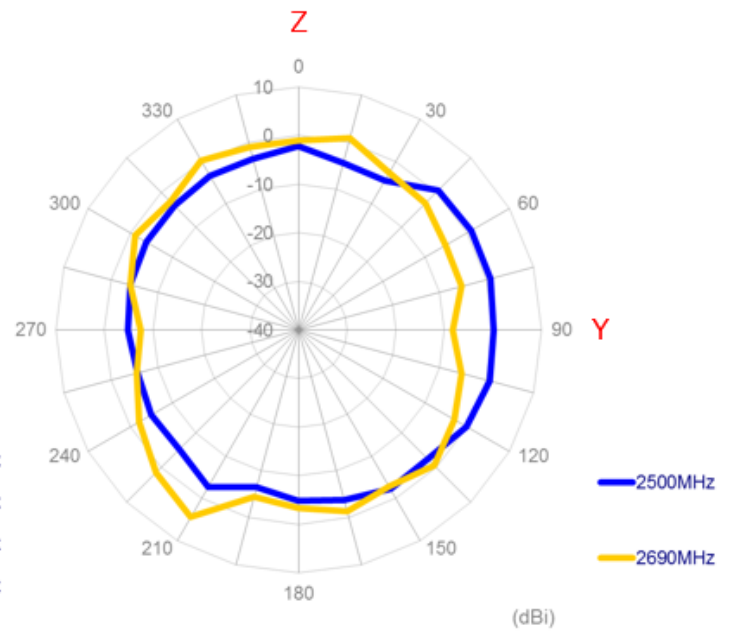
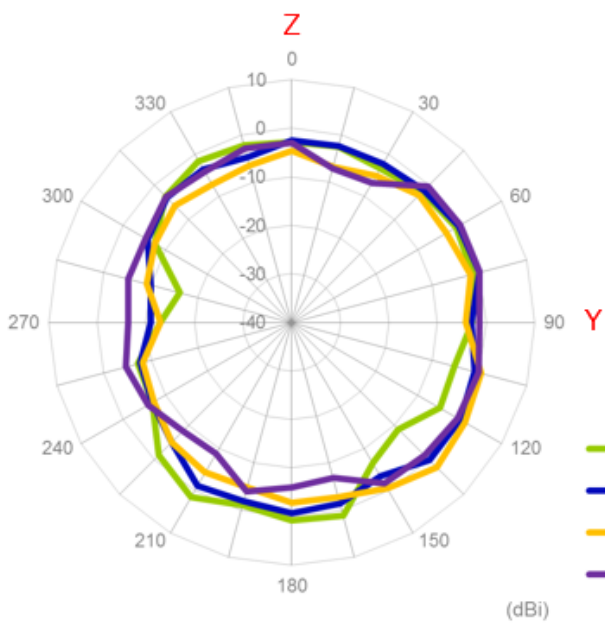
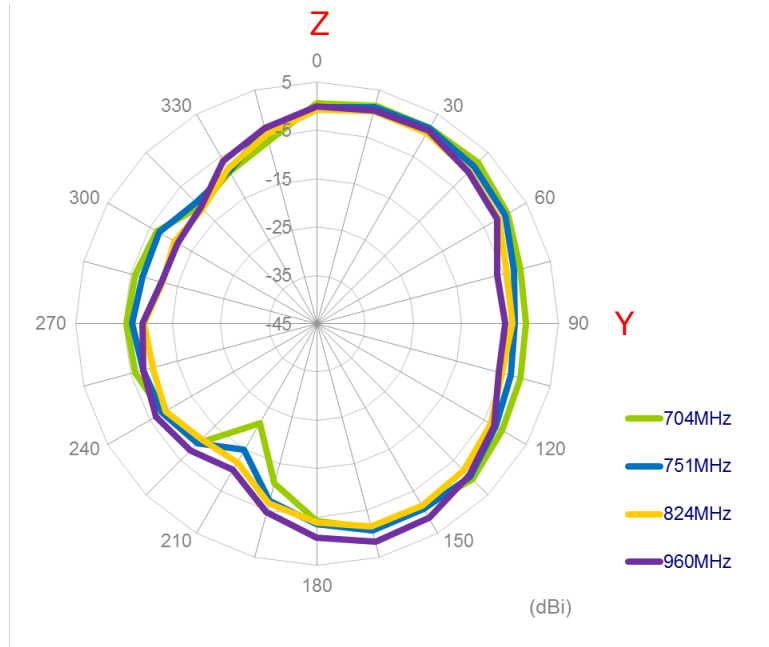

3.3.6. LTE with 2M cable length on the glass (MIMO 1)

XY Plane

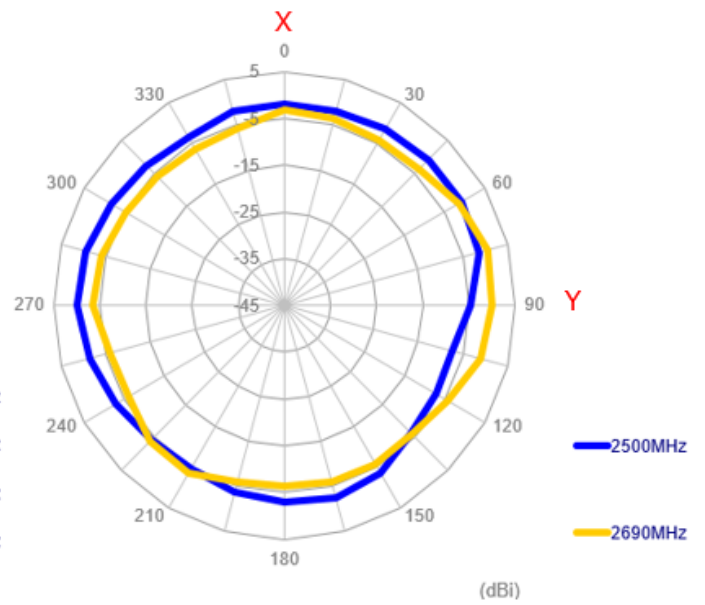
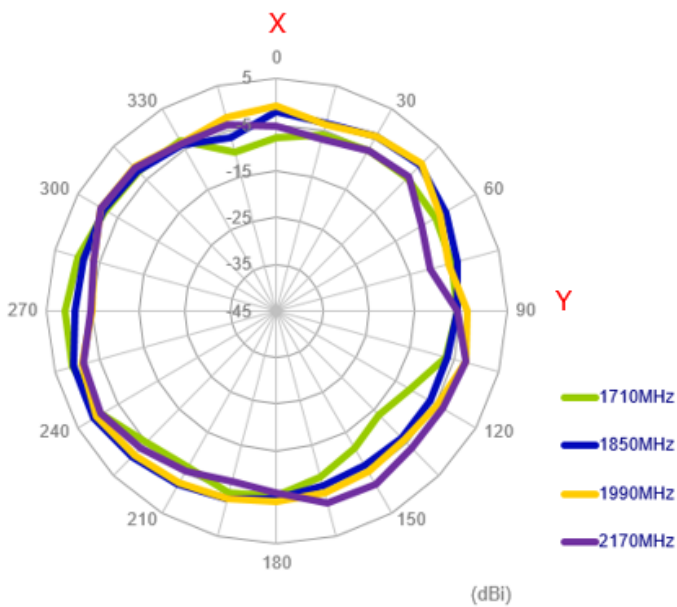
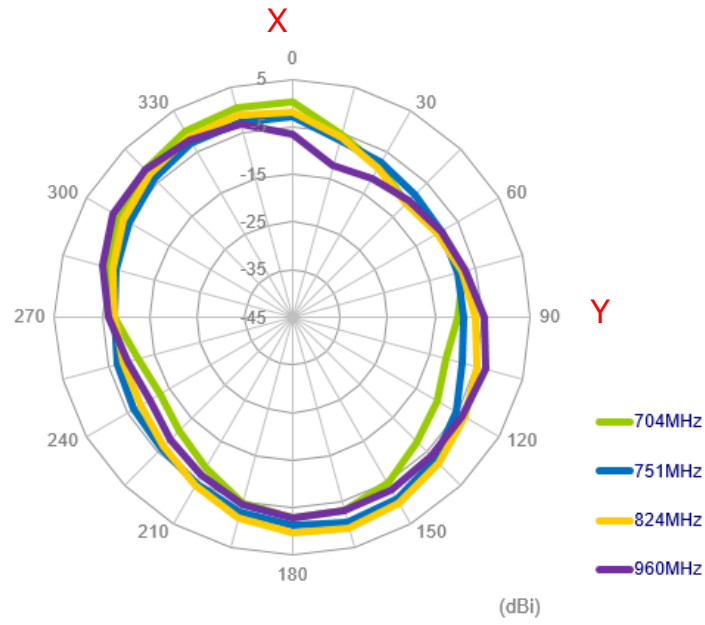

XZ Plane

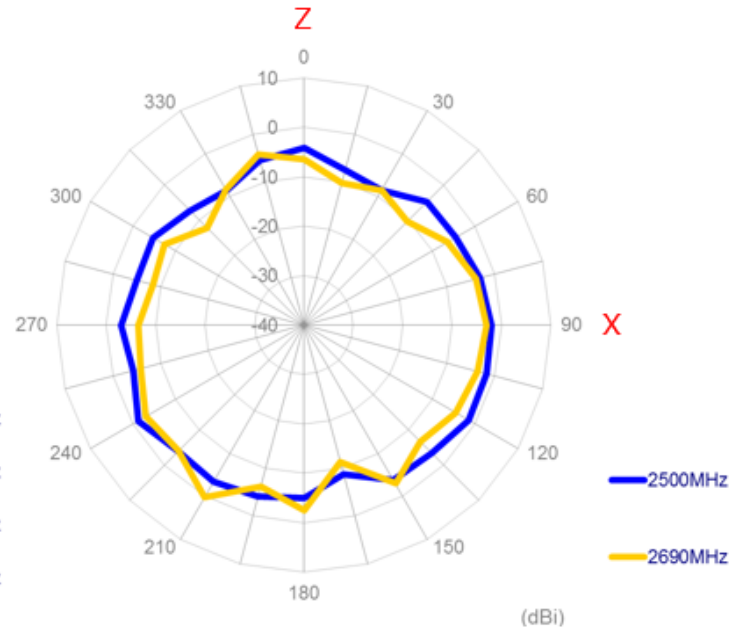
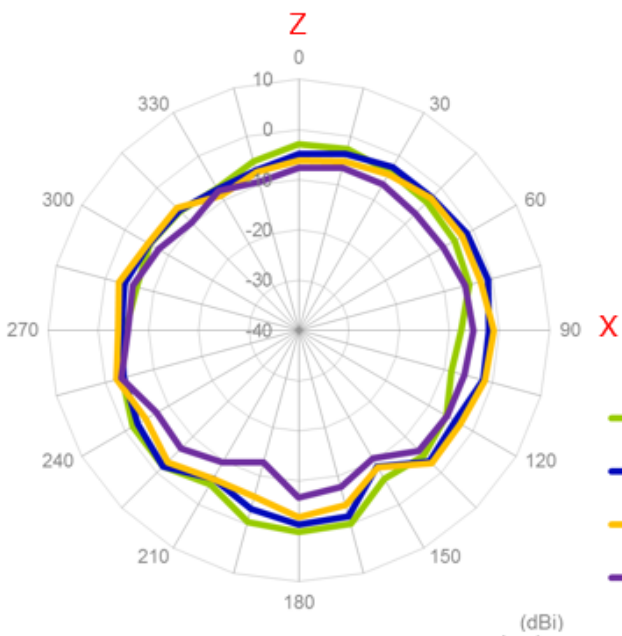
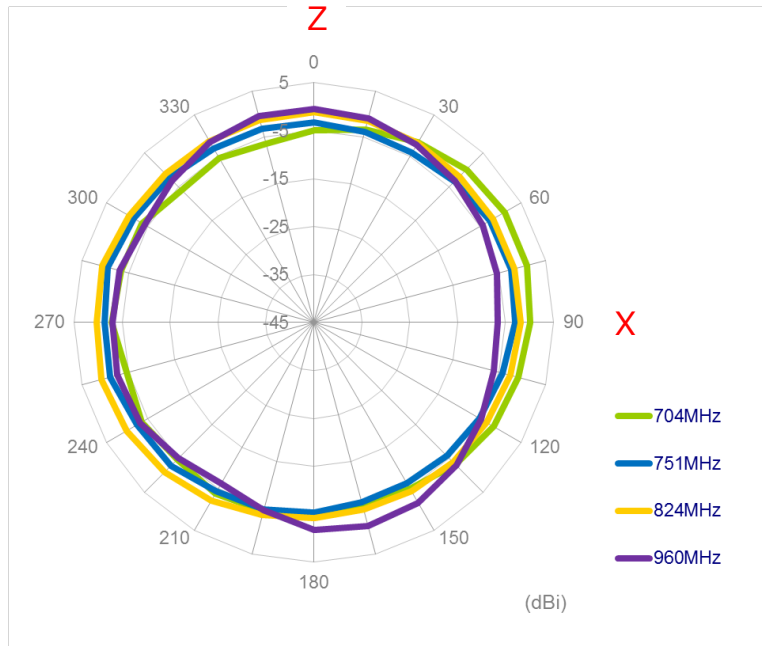

YZ Plane

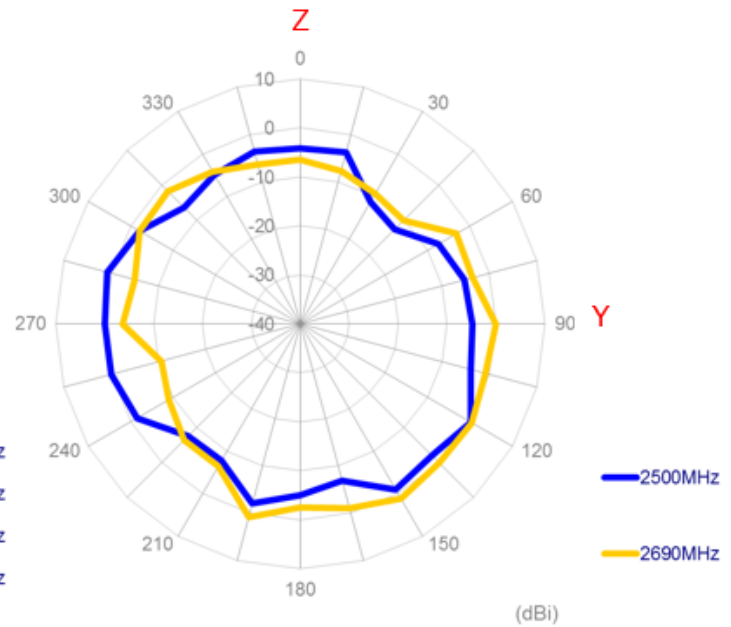
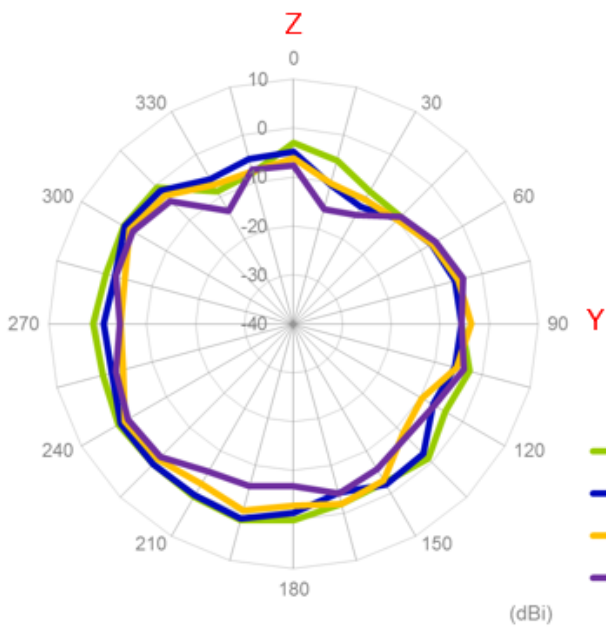
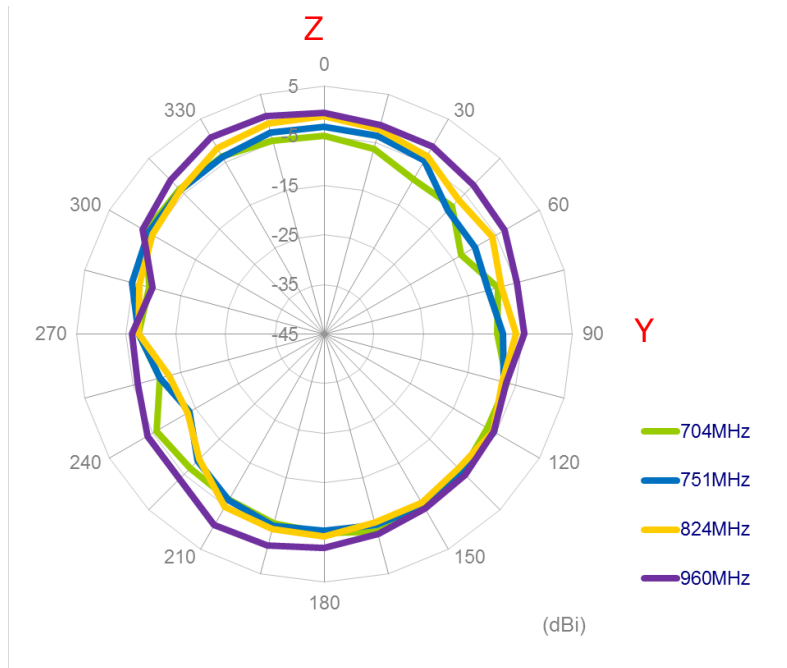

3.3.7. LTE with 2M cable length on the glass (MIMO 2)

XY Plane

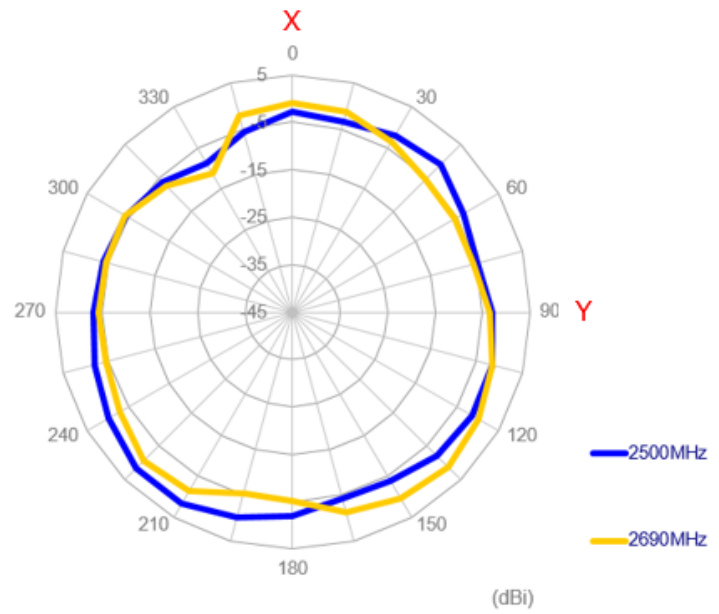
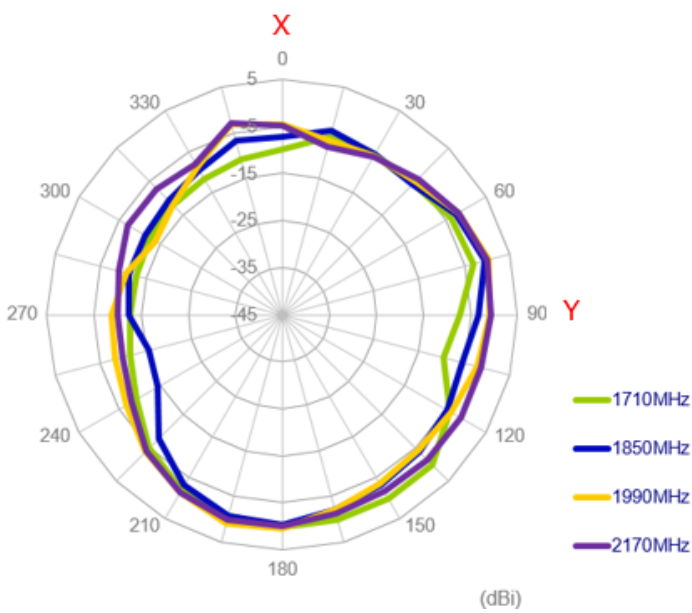
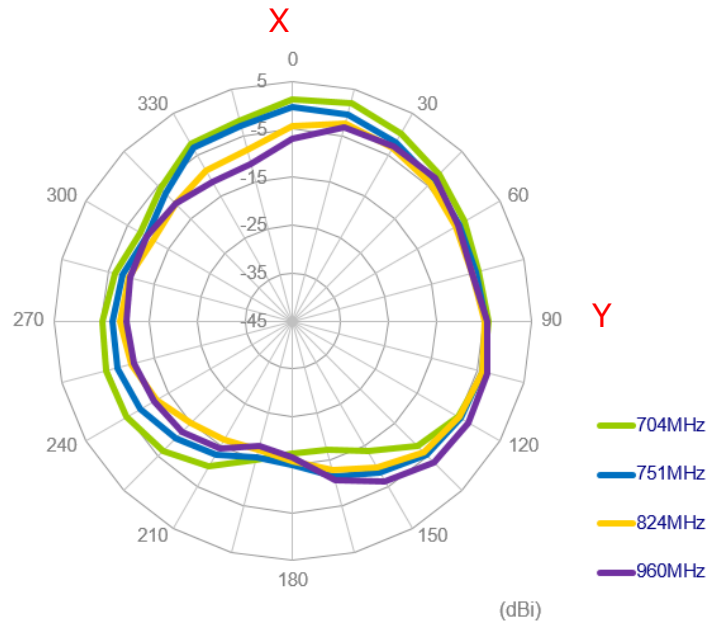

XZ Plane

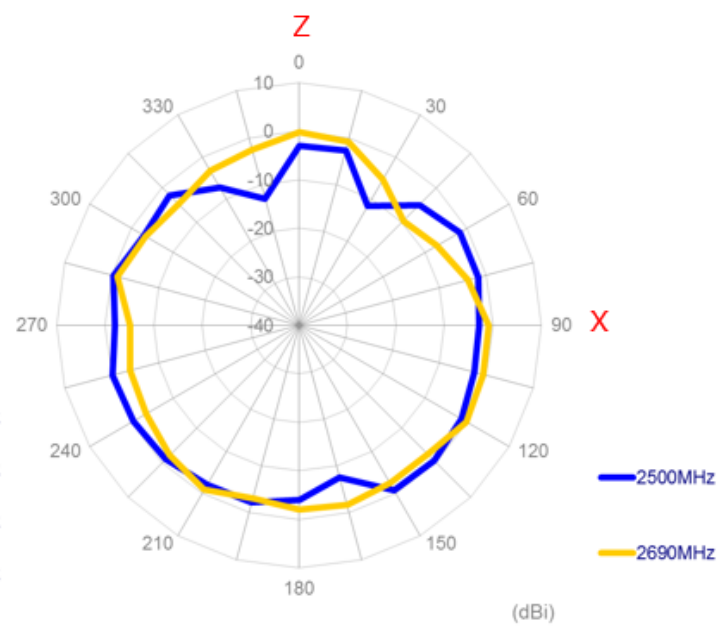
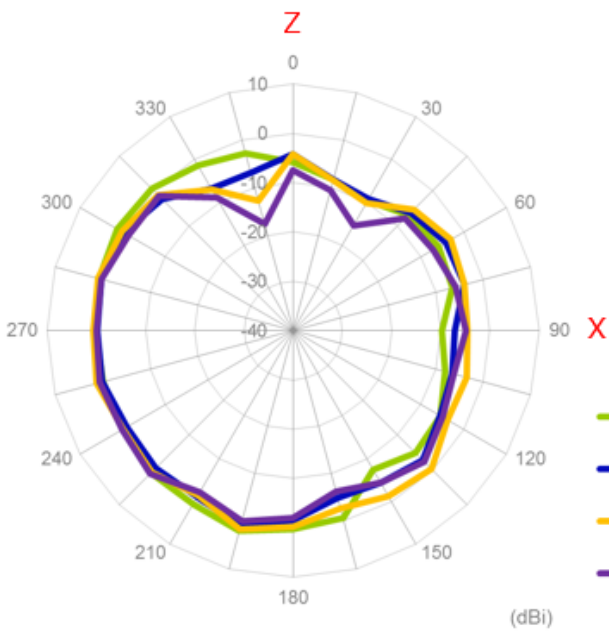
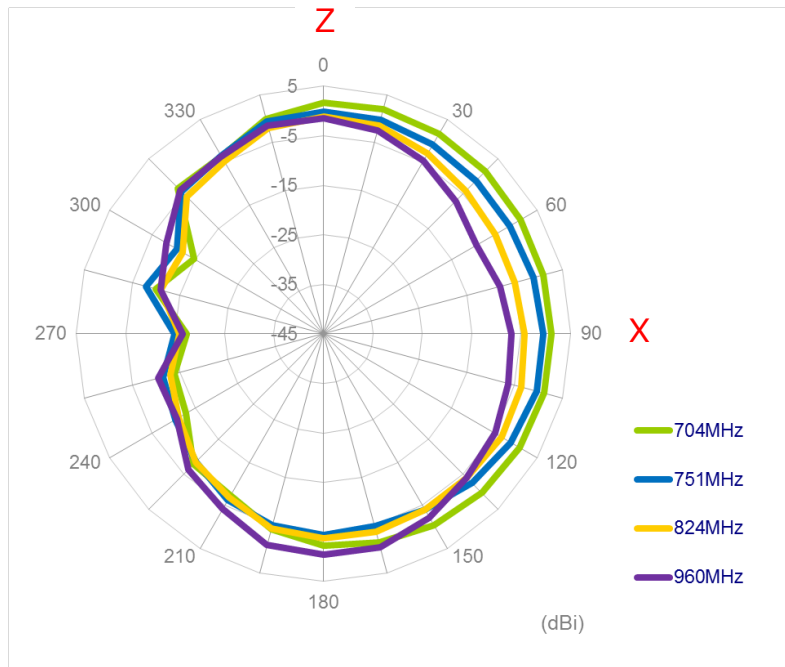

YZ Plane

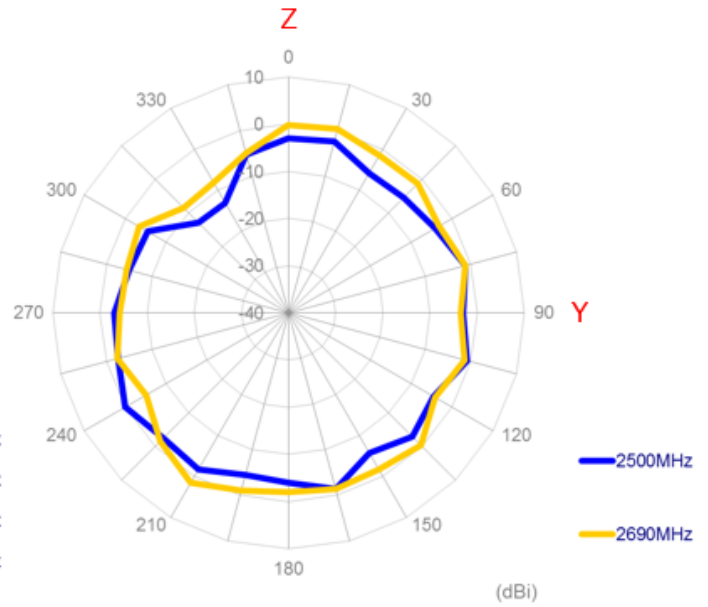
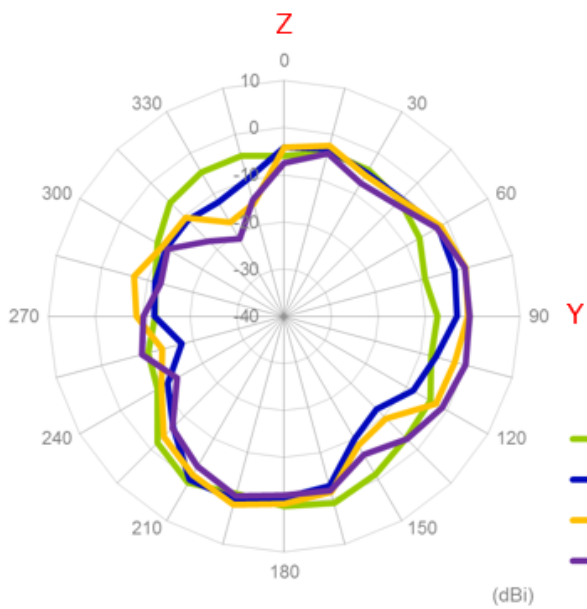
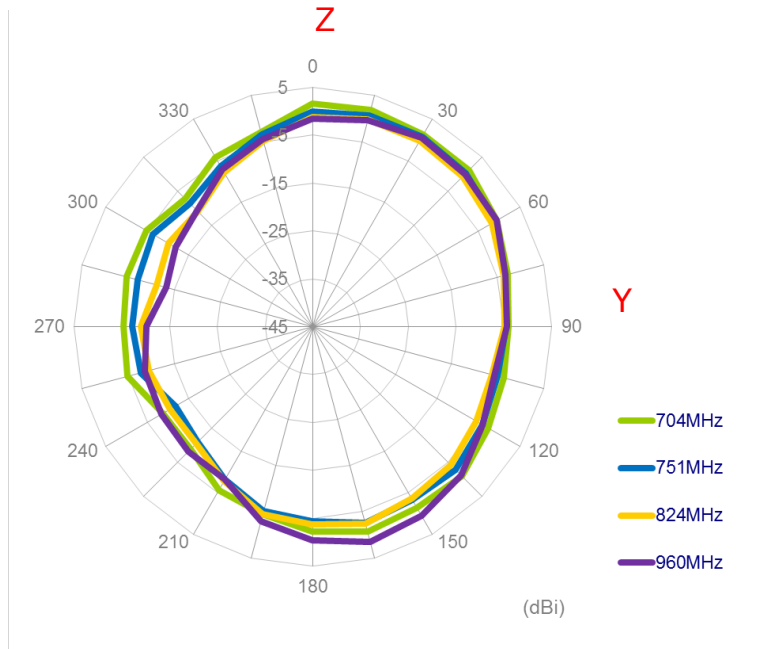

3.3.8. GPS/GLONASS/BeiDou

XY Plane

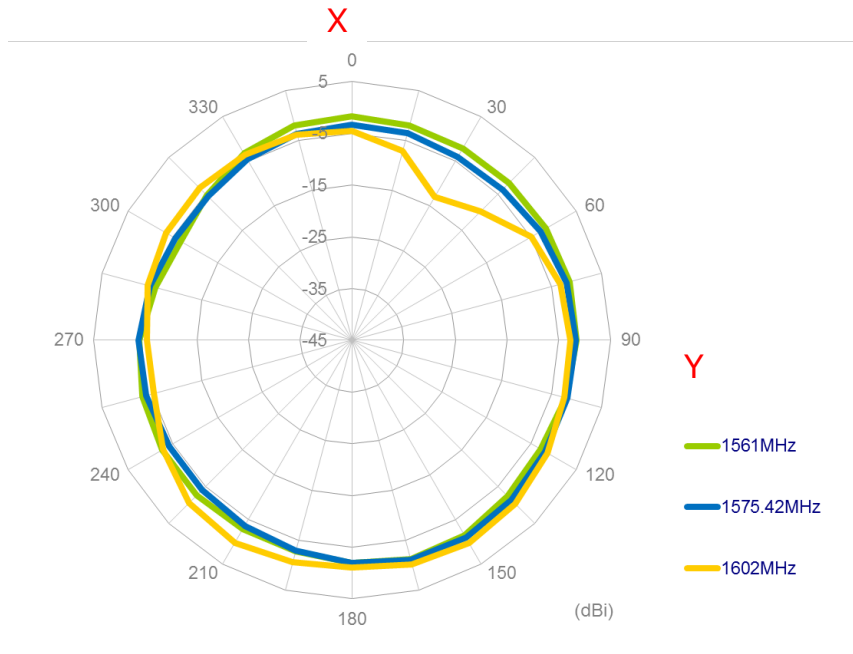

XZ Plane

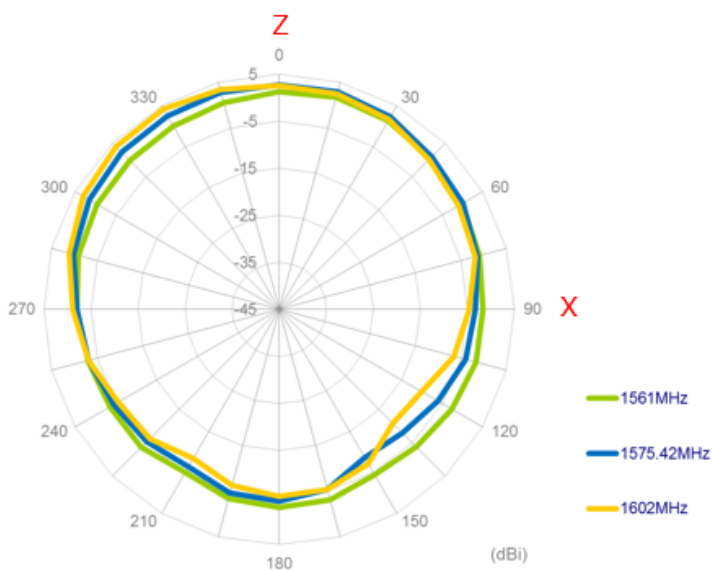

YZ Plane

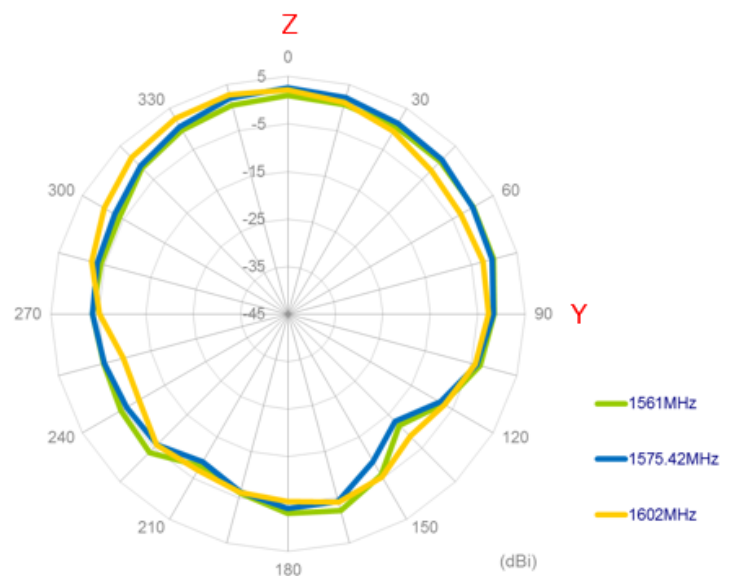

3.4. 3D Radiation Pattern

3.4.1. LTE with 2M cable length in free space (MIMO 1)

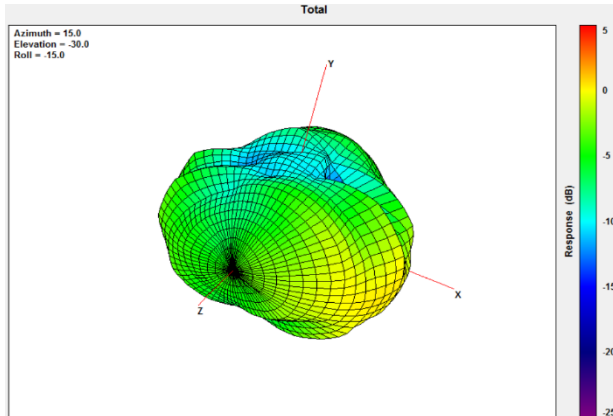

704MHz

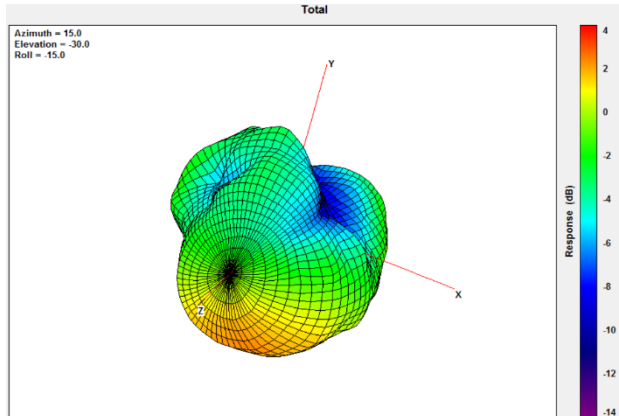

960MHz

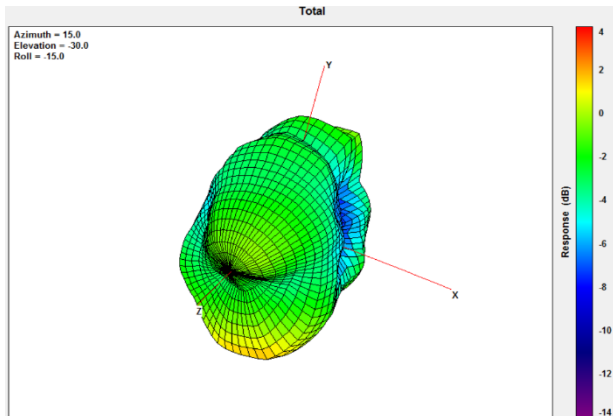

1710MHz

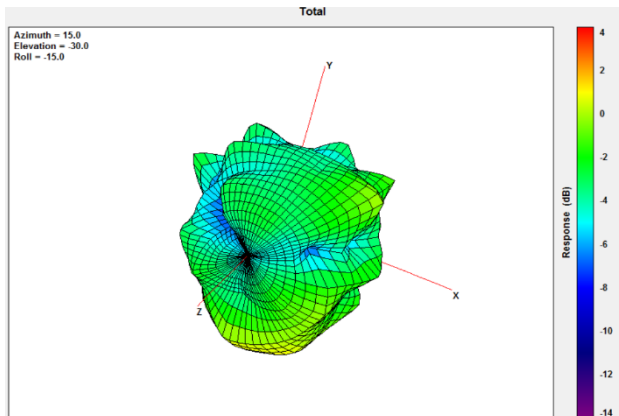

2170MHz

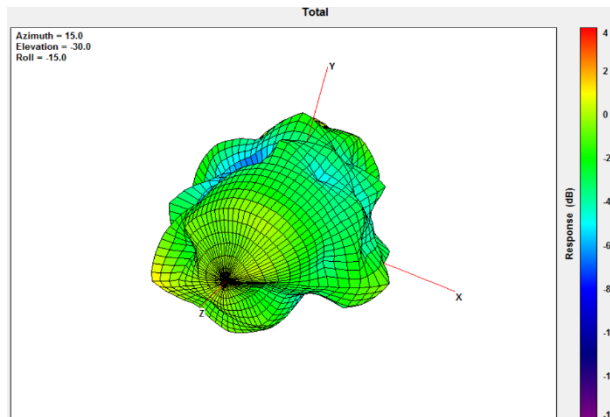

2690MHz

3.4.2. LTE with 2M cable length in free space (MIMO 2)

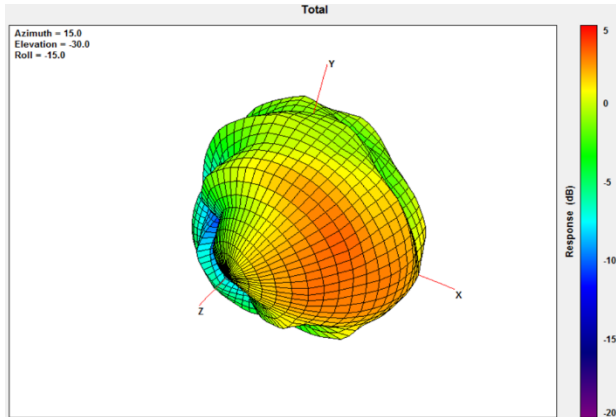

704MHz

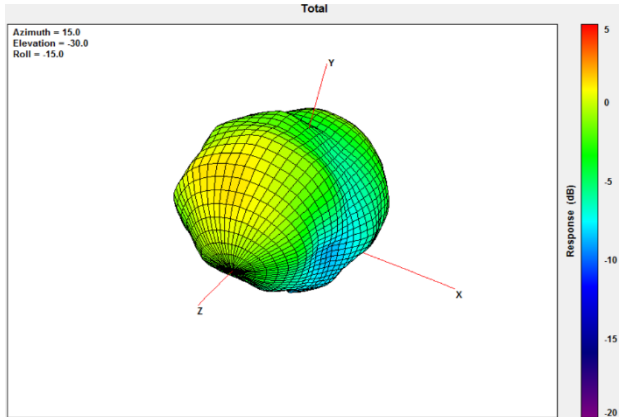

960MHz

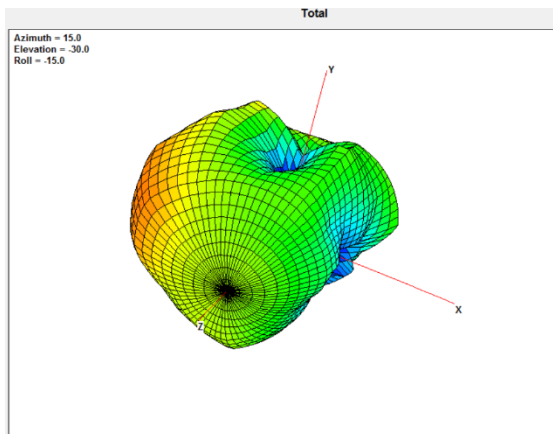

1710MHz

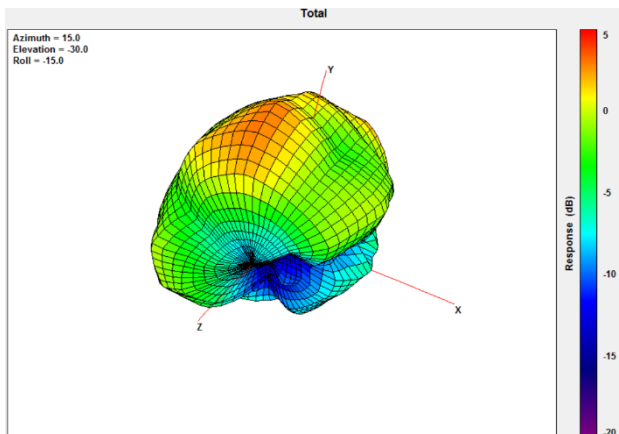

2170MHz

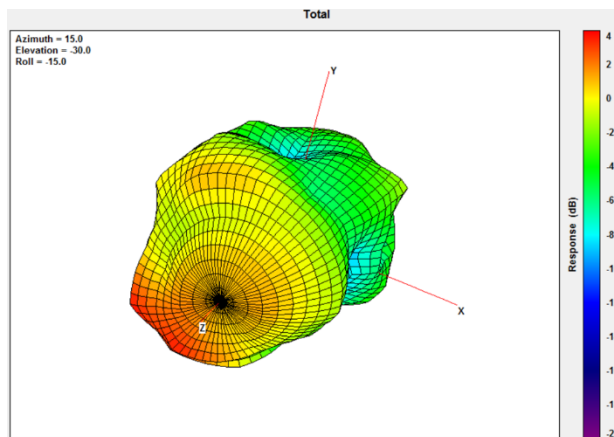

2690MHz

3.4.3. LTE with 2M cable length on the 2mm ABS (MIMO 1)

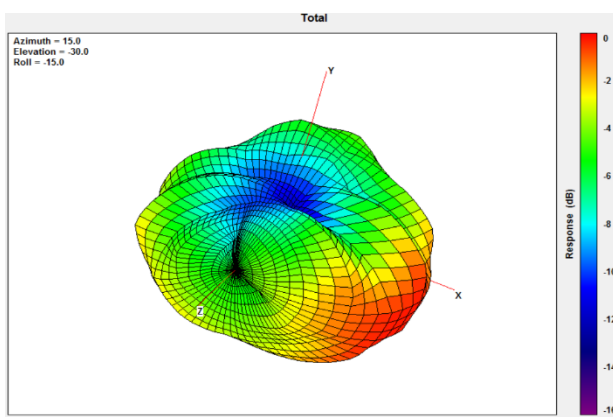

704MHz

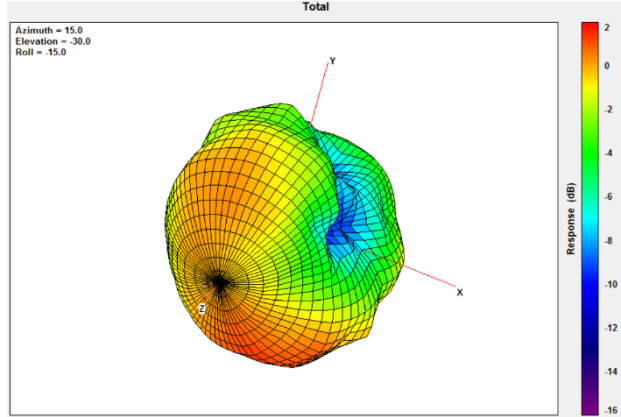

960MHz

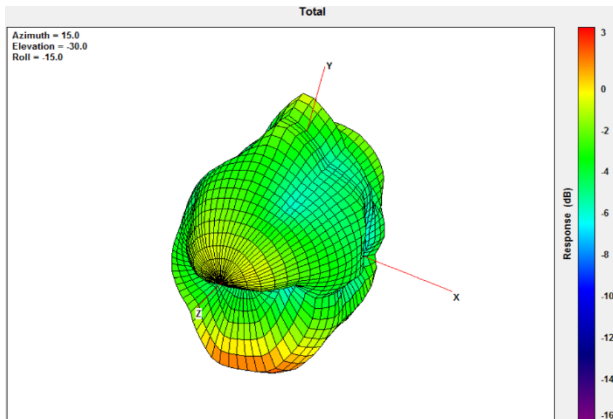

1710MHz

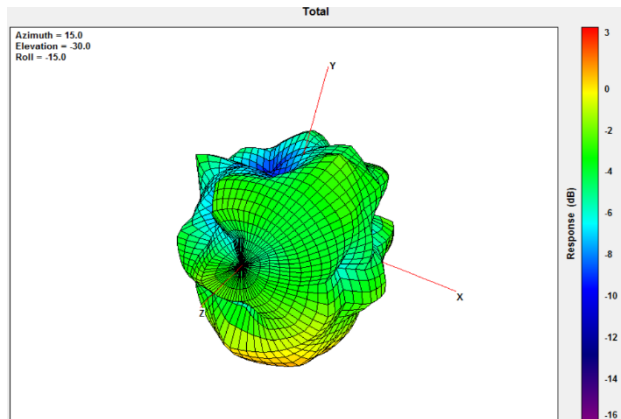

2170MHz

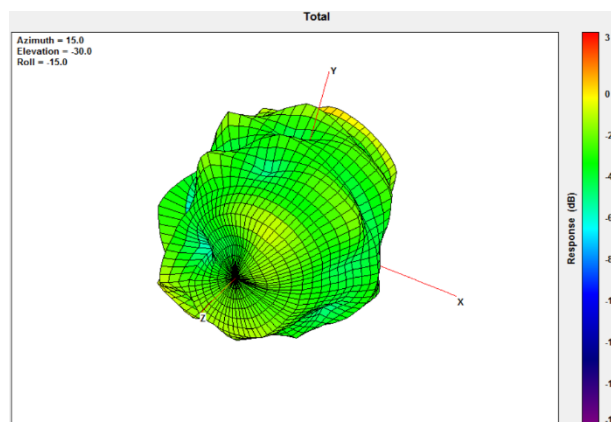

2690MHz

3.4.4. LTE with 2M cable length on the 2mm ABS (MIMO 2)

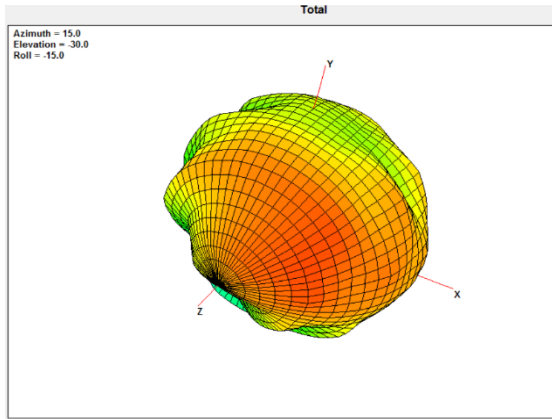

704MHz

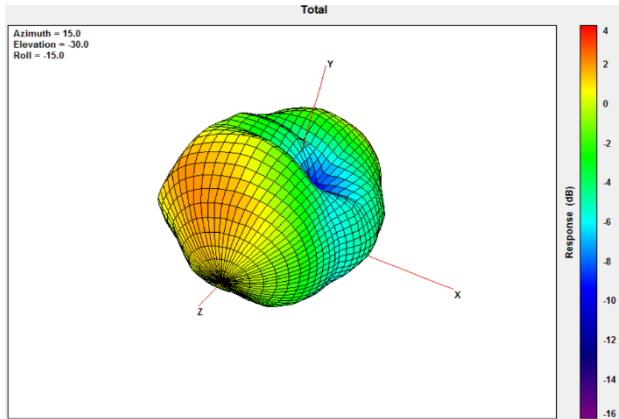

960MHz

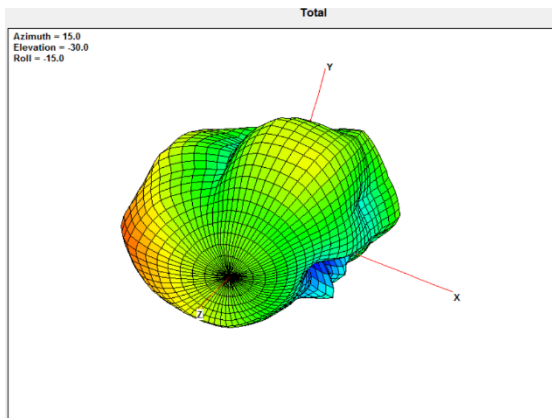

1710MHz

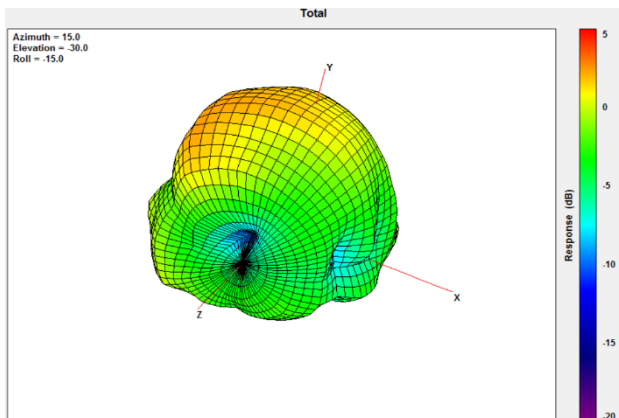

2170MHz

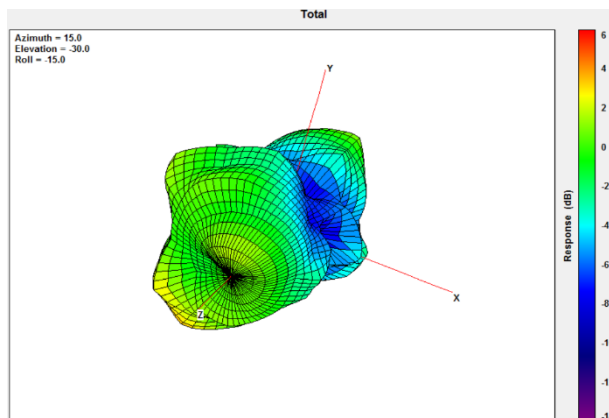

2690MHz

3.4.5. LTE with 2M cable length on the glass (MIMO 1)

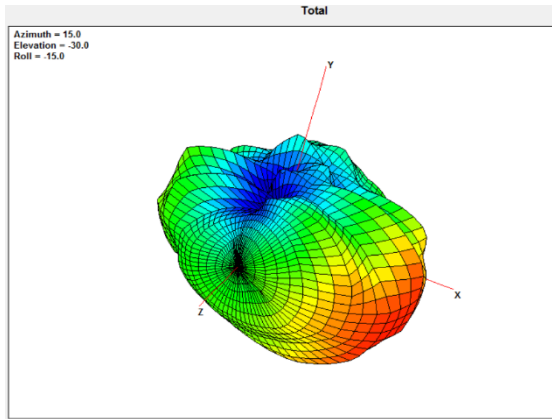

704MHz

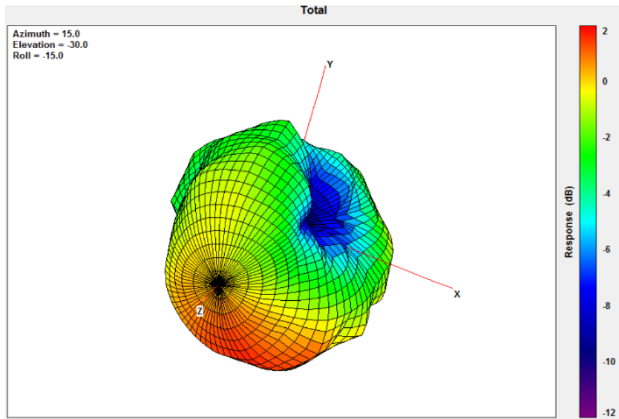

960MHz

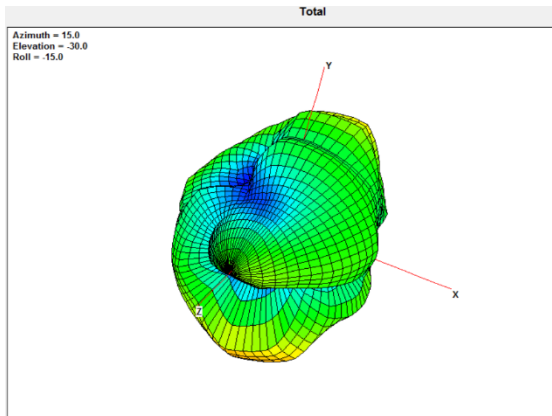

1710MHz

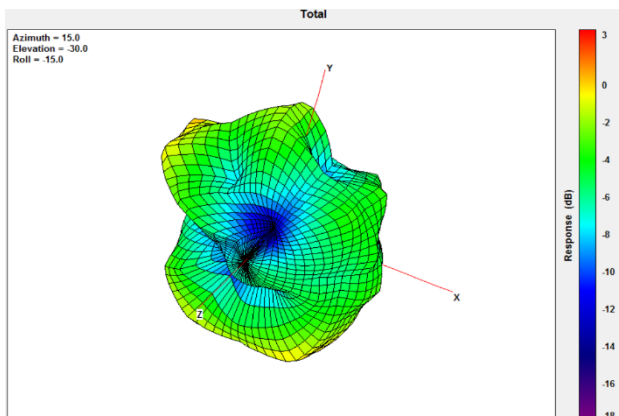

2170MHz

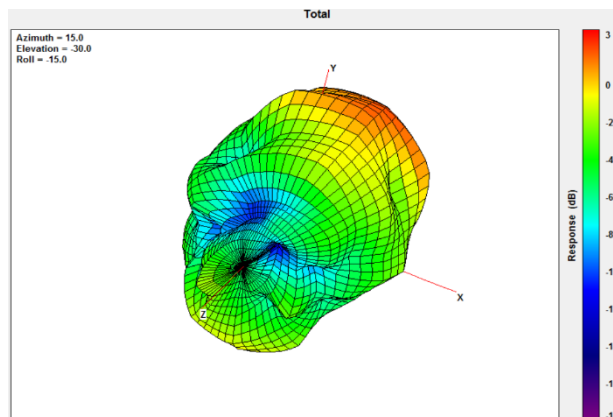

2690MHz

3.4.6. LTE with 2M cable length on the glass (MIMO 2)

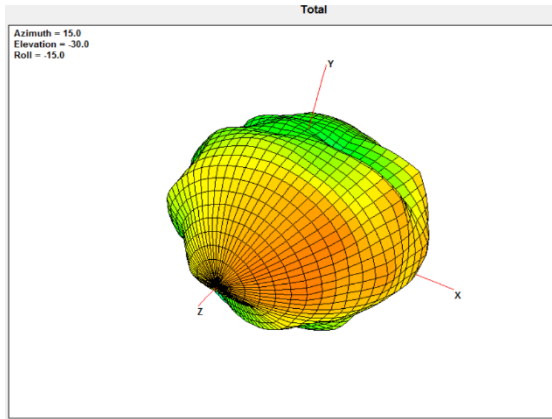

704MHz

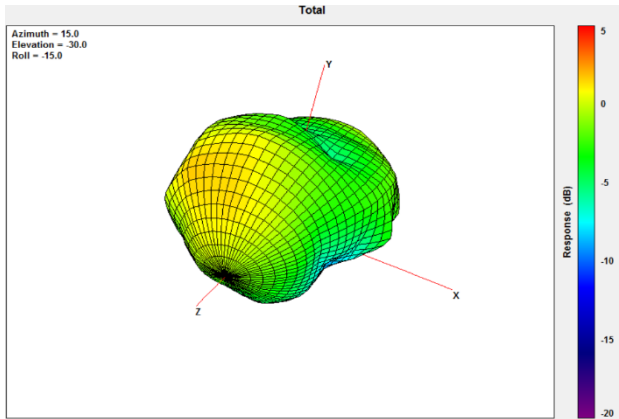

960MHz

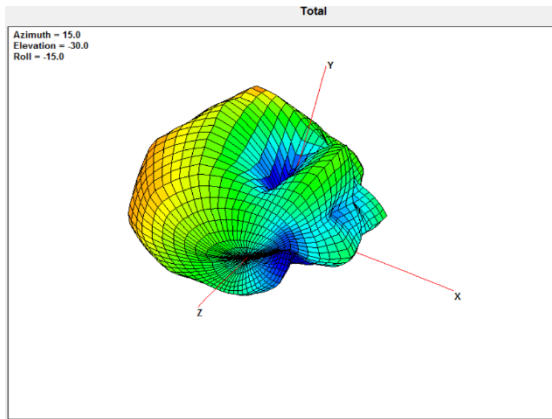

1710MHz

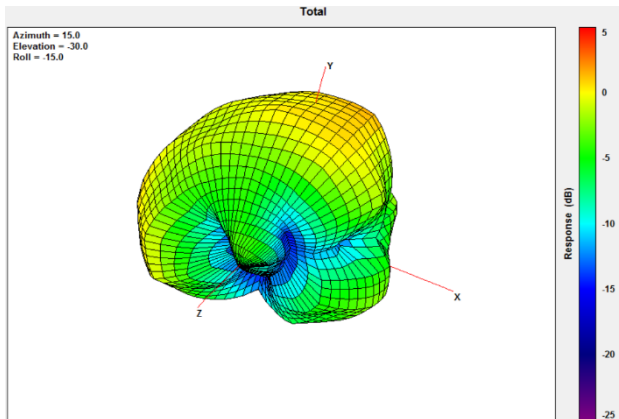

2170MHz

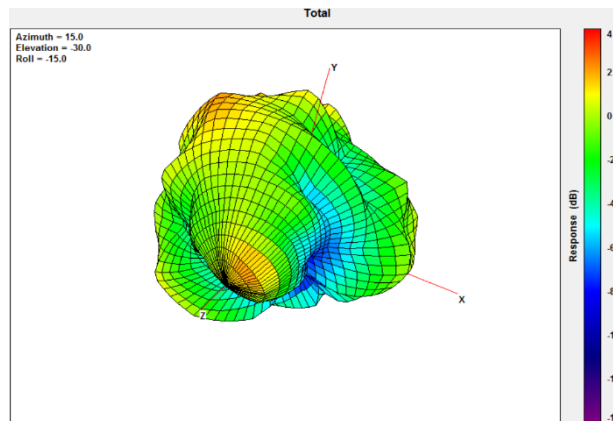

2690MHz

3.4.7. GPS/GLONASS/BeiDou

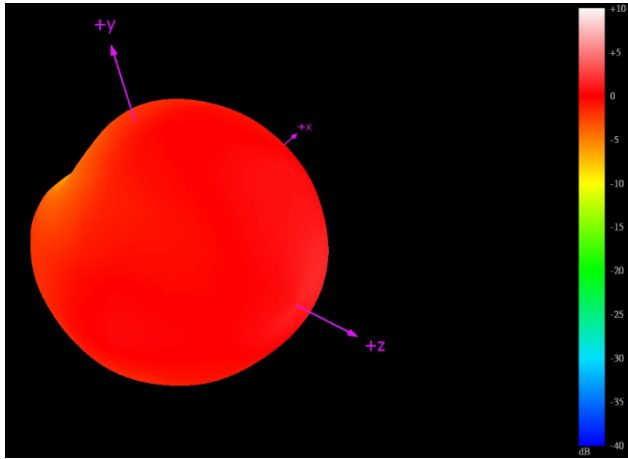

1561MHz

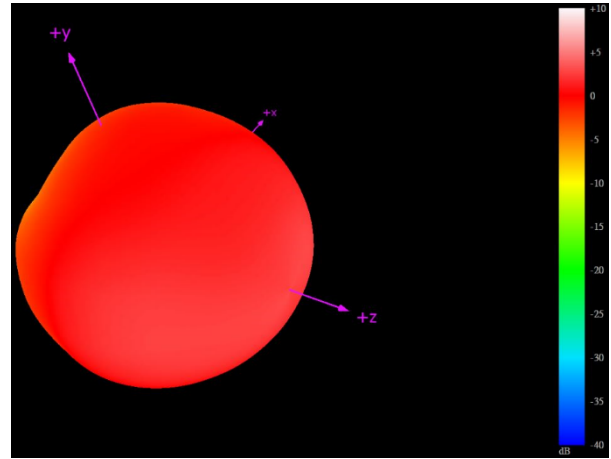

1575.42MHz

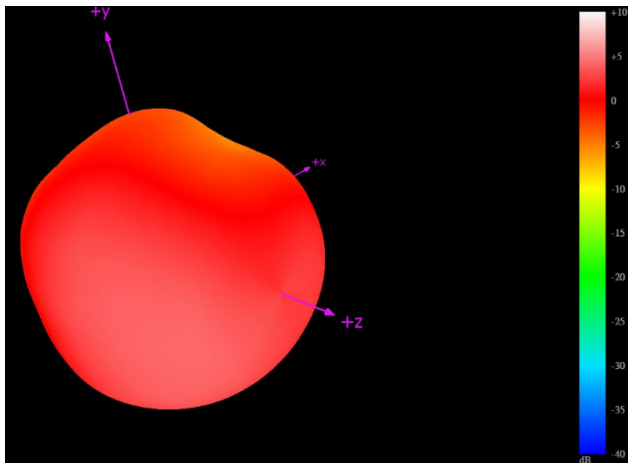

1602MHz

4. Drawing

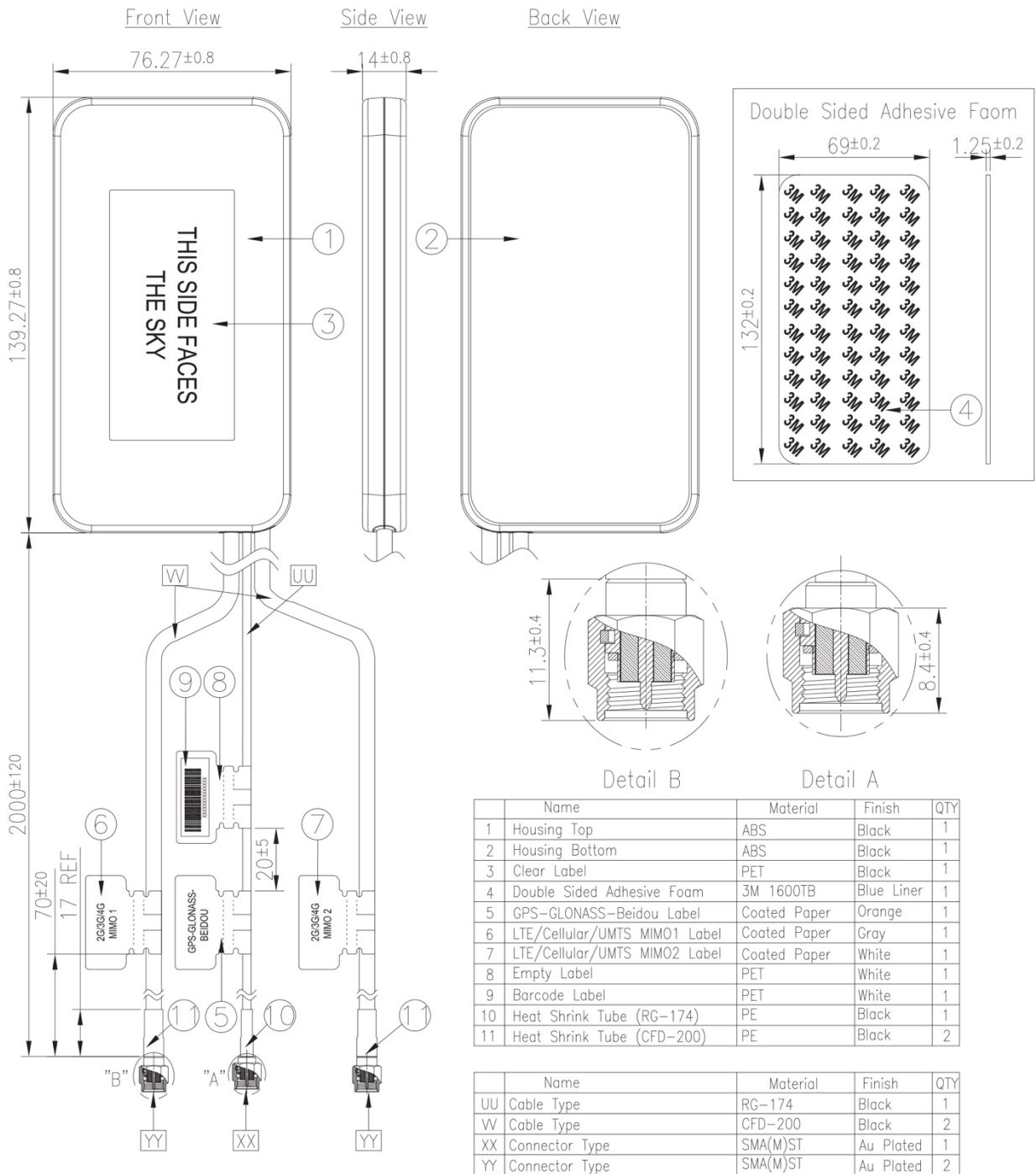

5. Packaging

1 pc MA250.A.LBI.003 per PE bag
 Dimensions - 300*200mm
 Total Weight - 410g

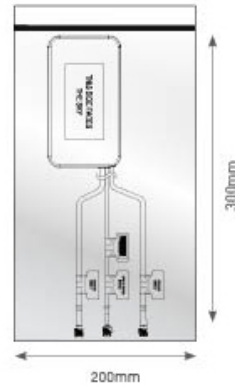

20 pcs MA250.A.LBI.003 per carton
 Carton Dimensions - 740*370*300mm
 Weight - 8.7kg

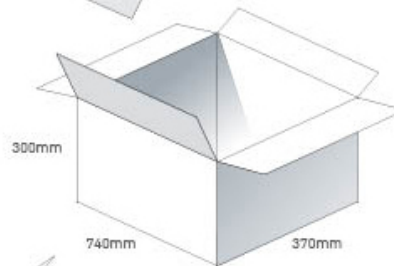

Pallet Dimensions 1200*1000*1400mm
 12 Cartons per pallet
 6 Cartons per layer
 2 Layers

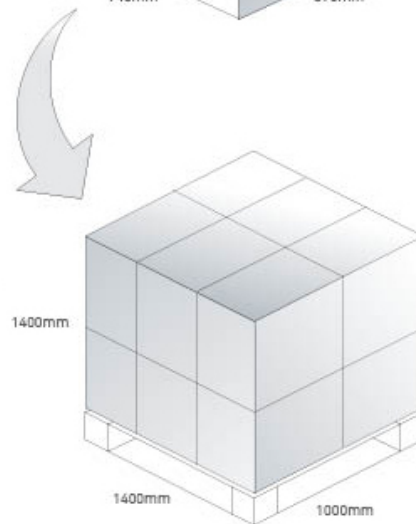

6. Application Note

The antenna was tested with different cable lengths and various base mounting options to indicate its performance to act as a reference for the customer's design

In Free Space

LTE MIMO 1

Return Loss

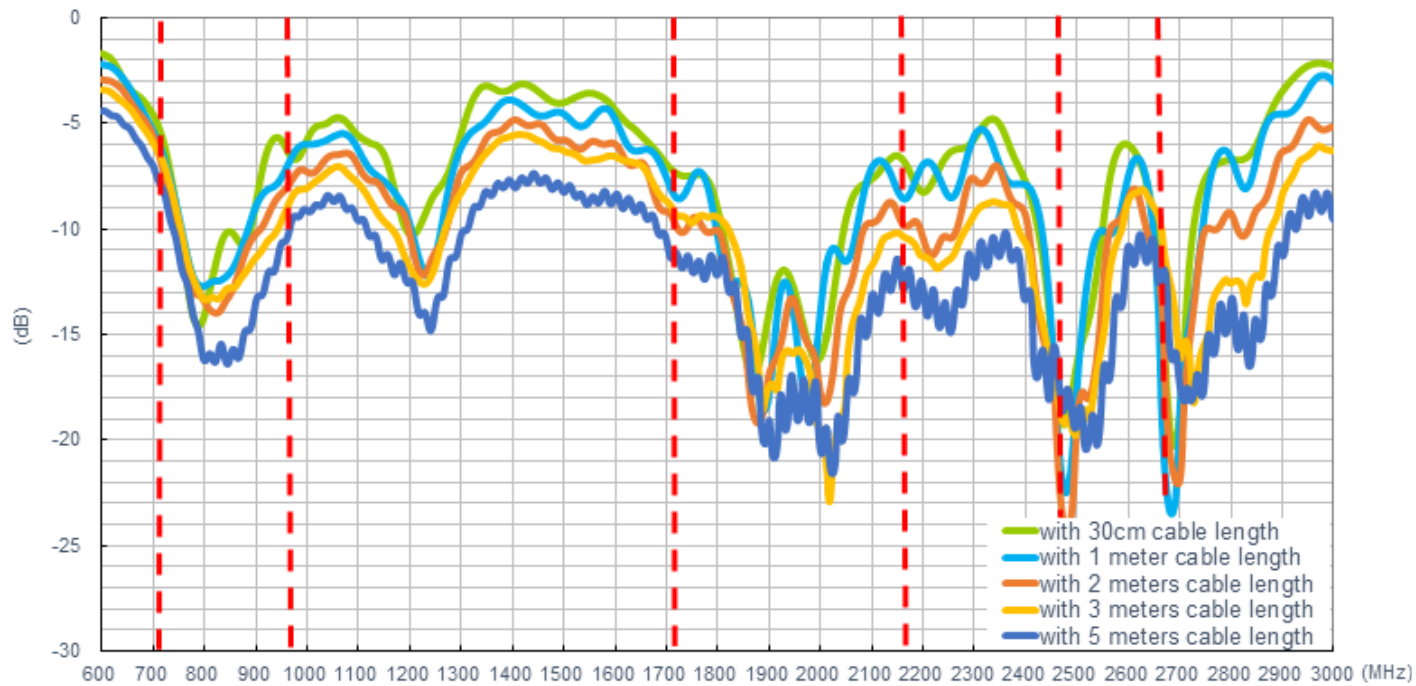

Efficiency

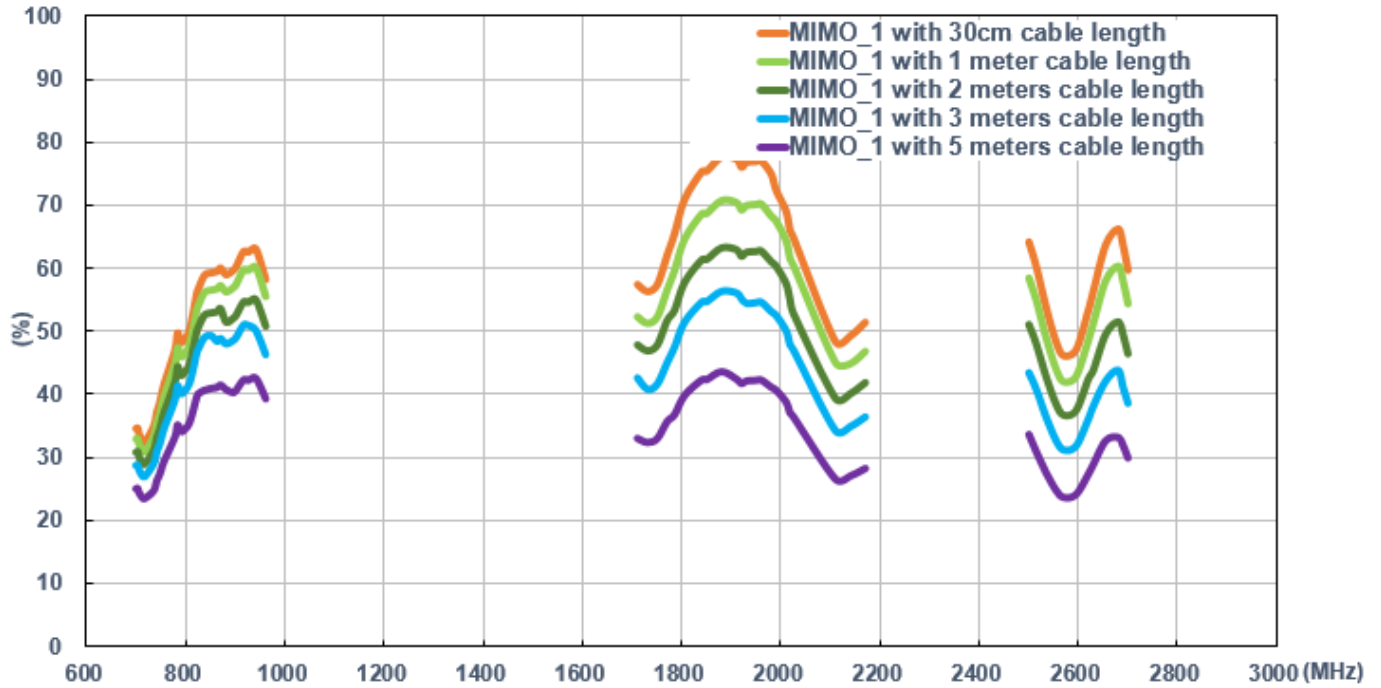

Average Gain

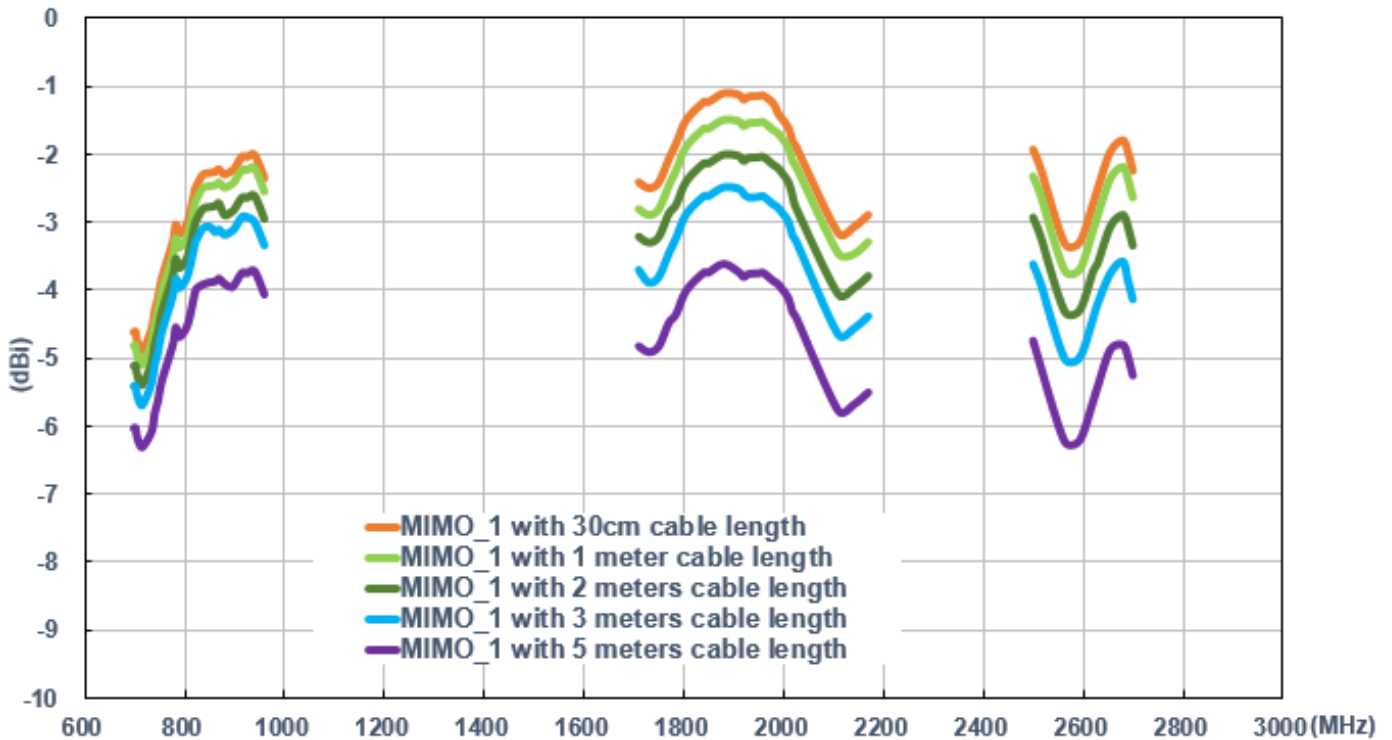

Peak Gain

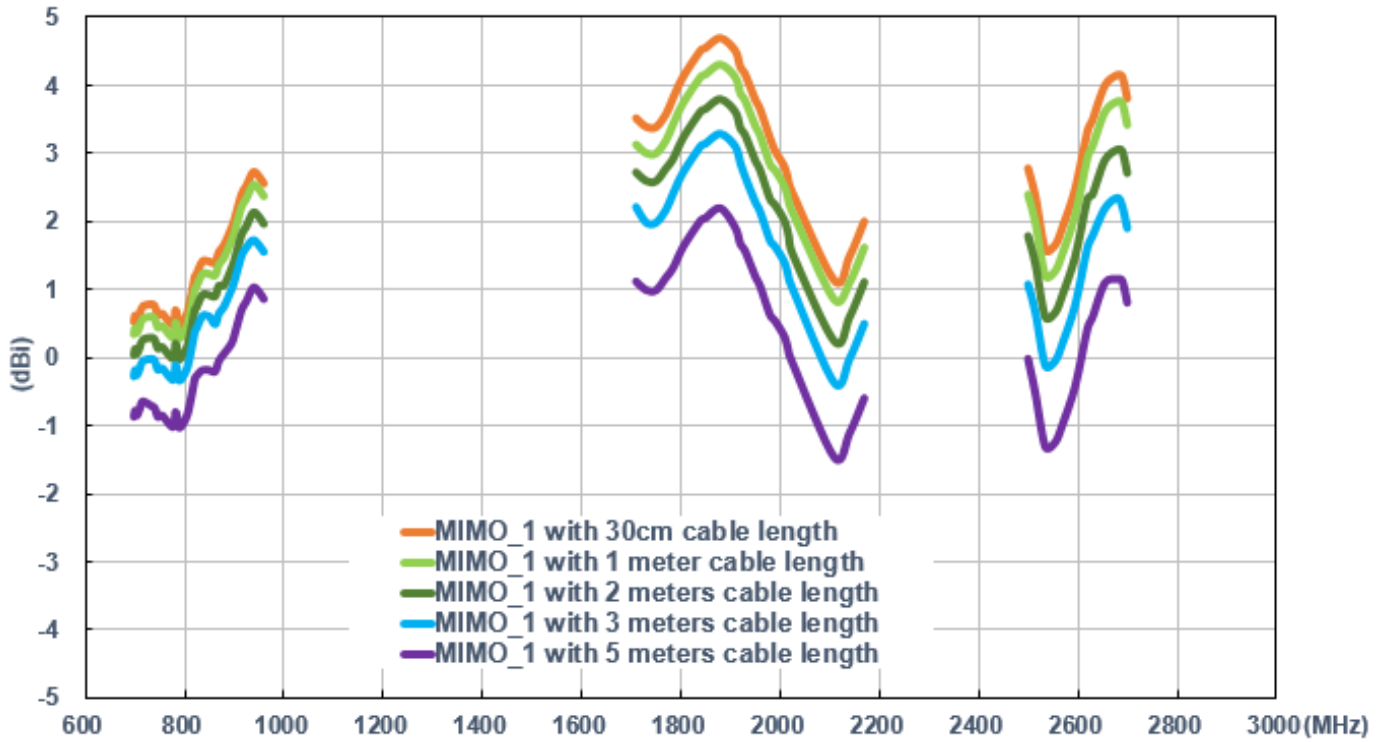

LTE MIMO 2

Return Loss

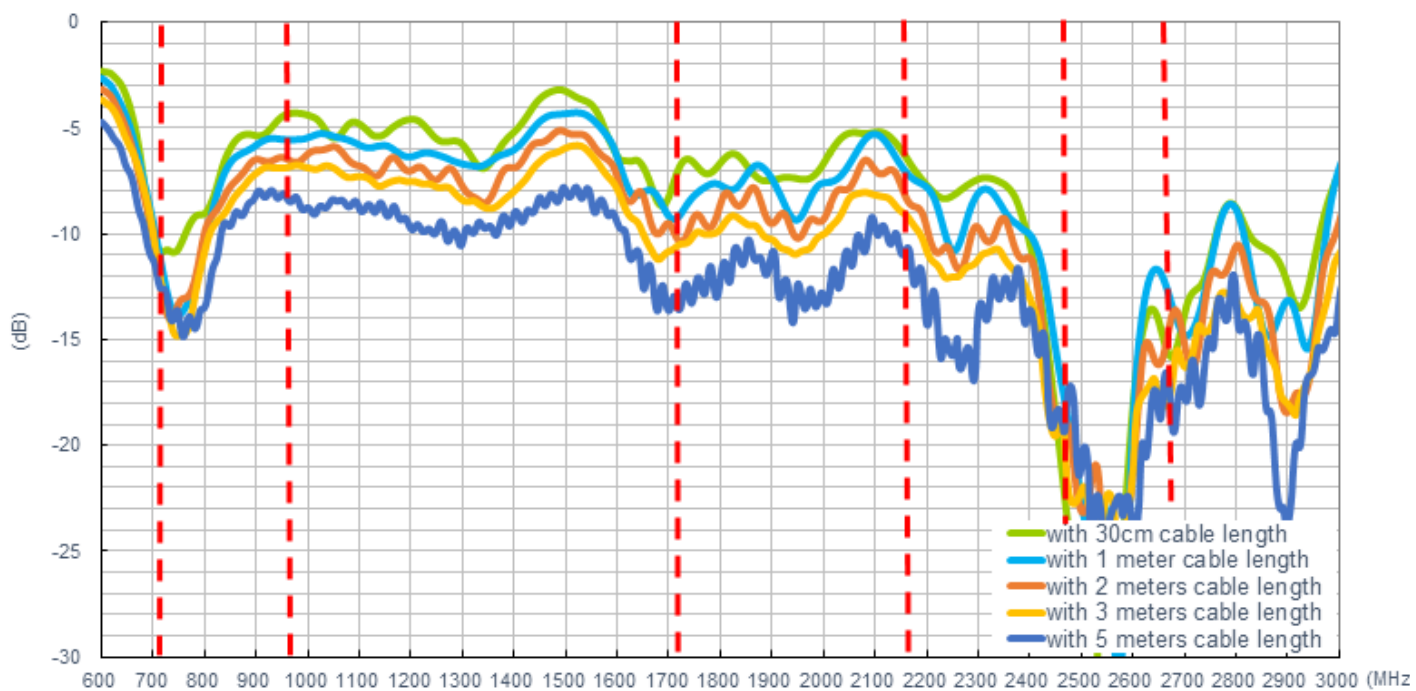

Efficiency

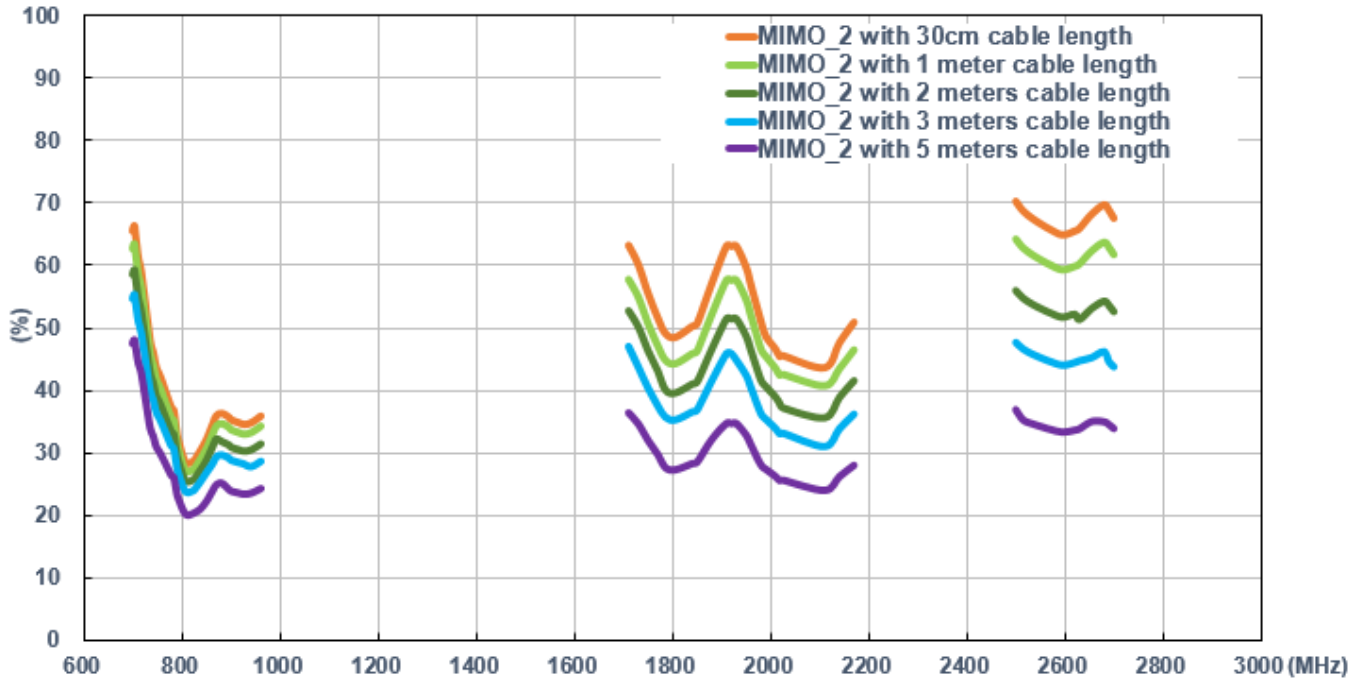

Average Gain

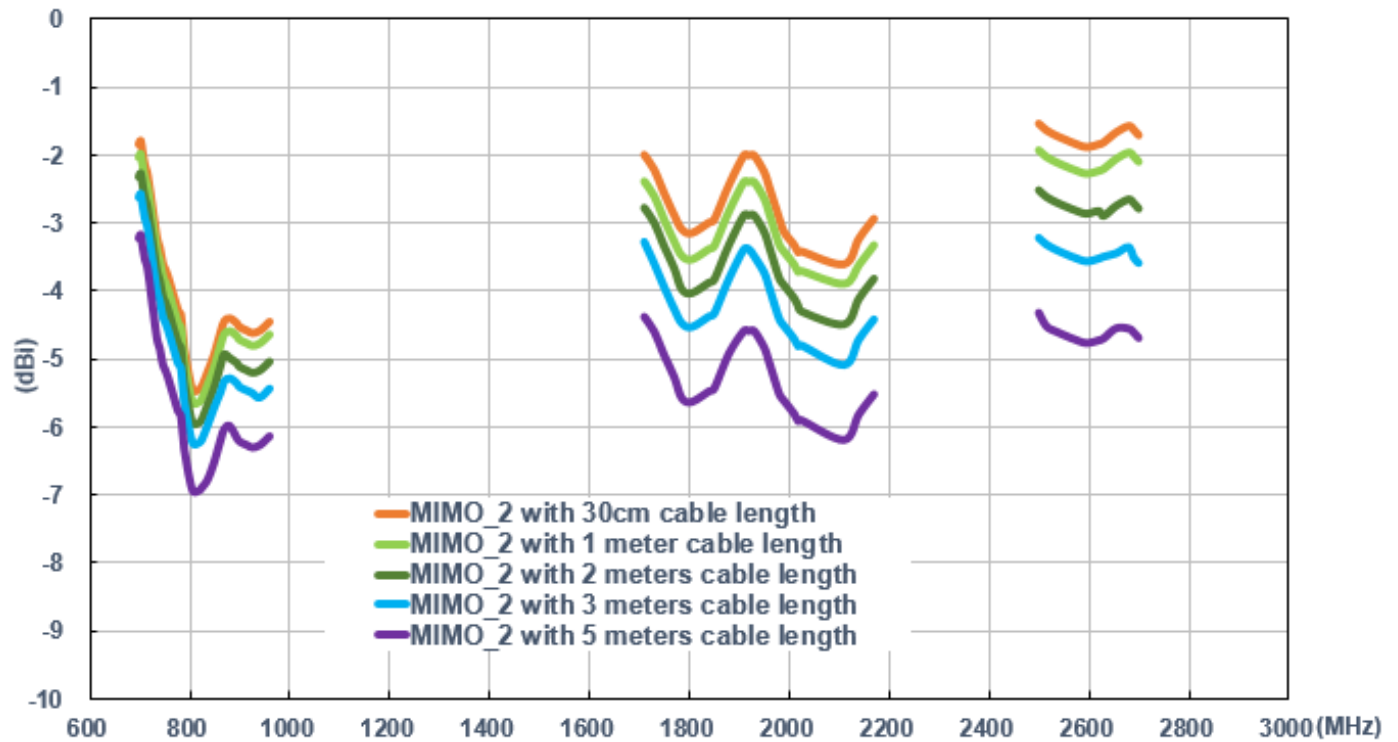

Peak Gain

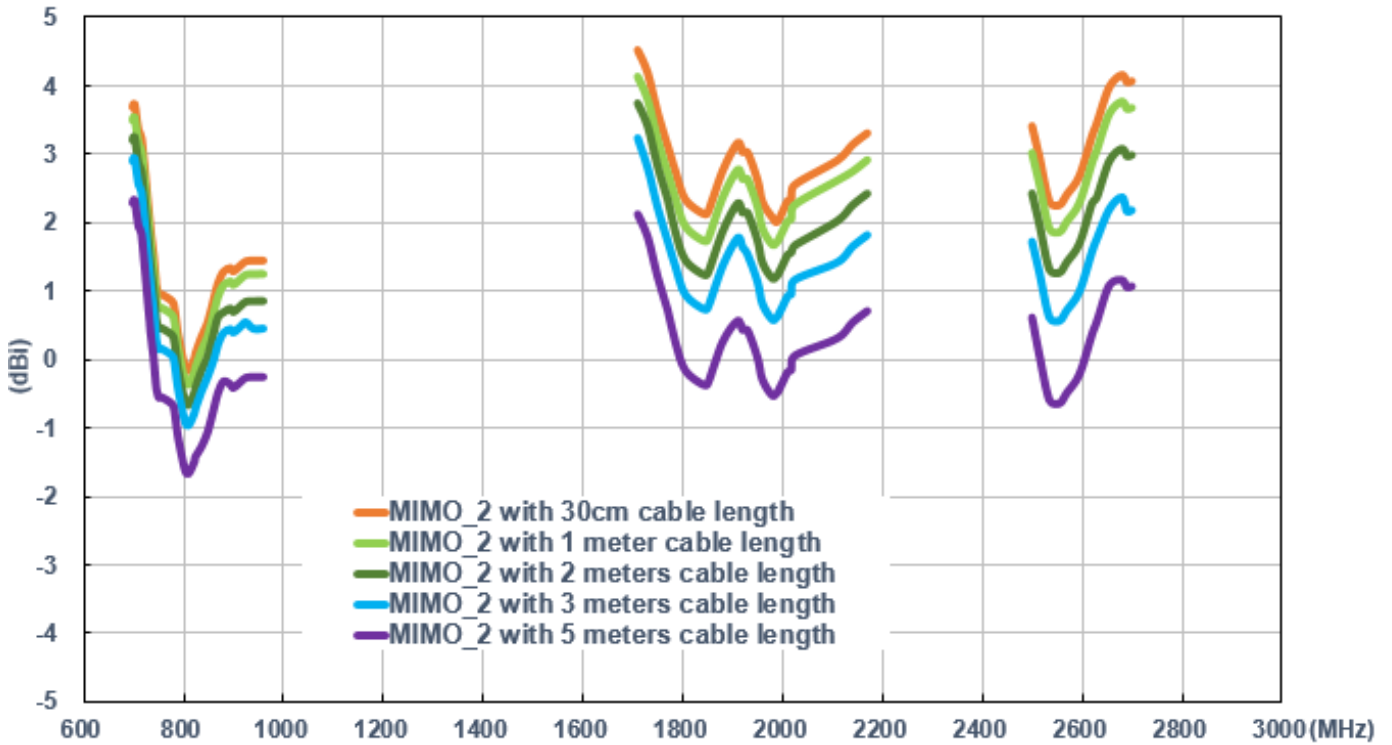

Isolation of MIMO 1 and MIMO 2

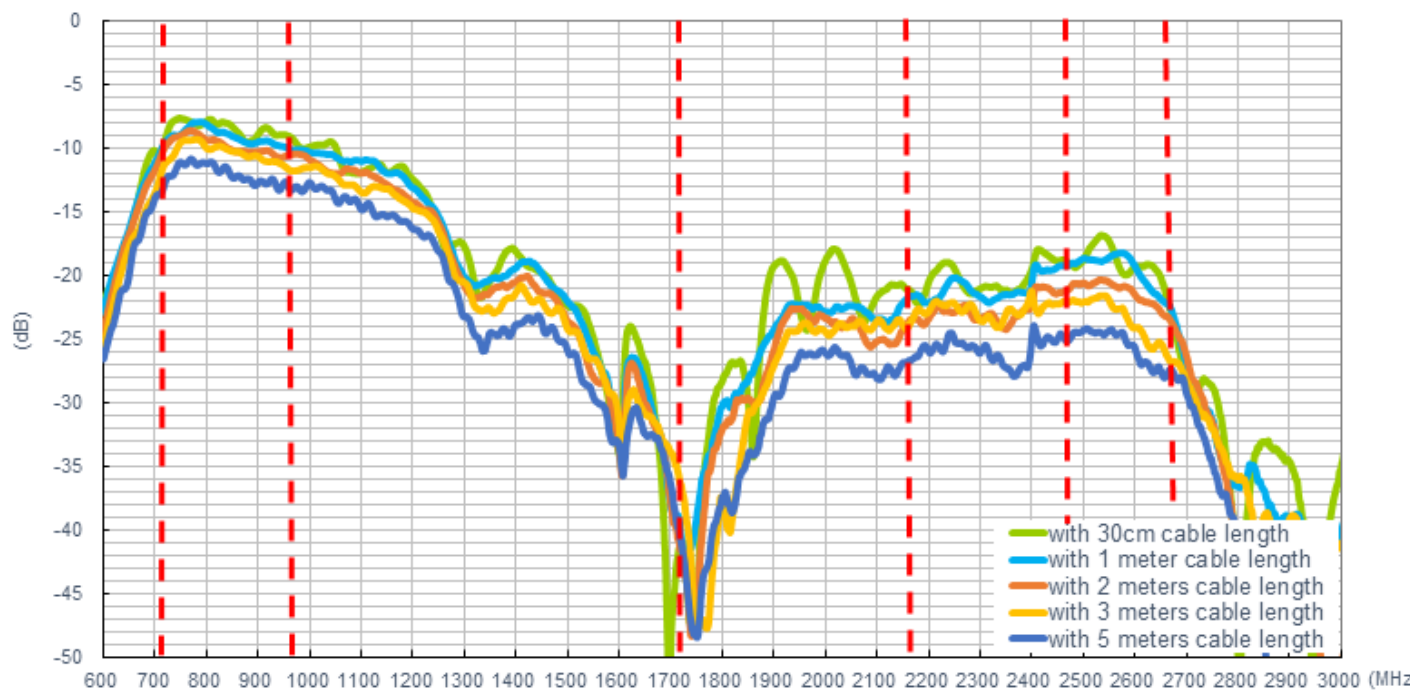

On 2mm ABS

LTE MIMO 1

Return Loss

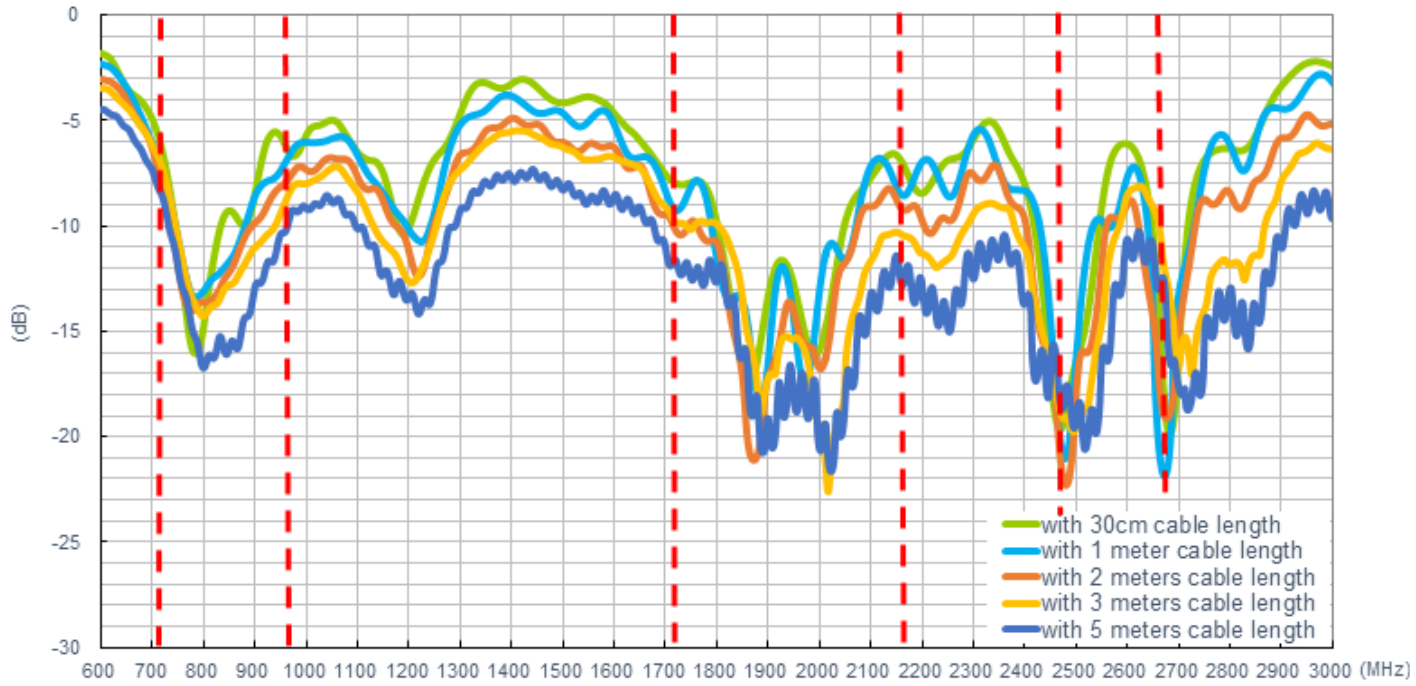

Efficiency

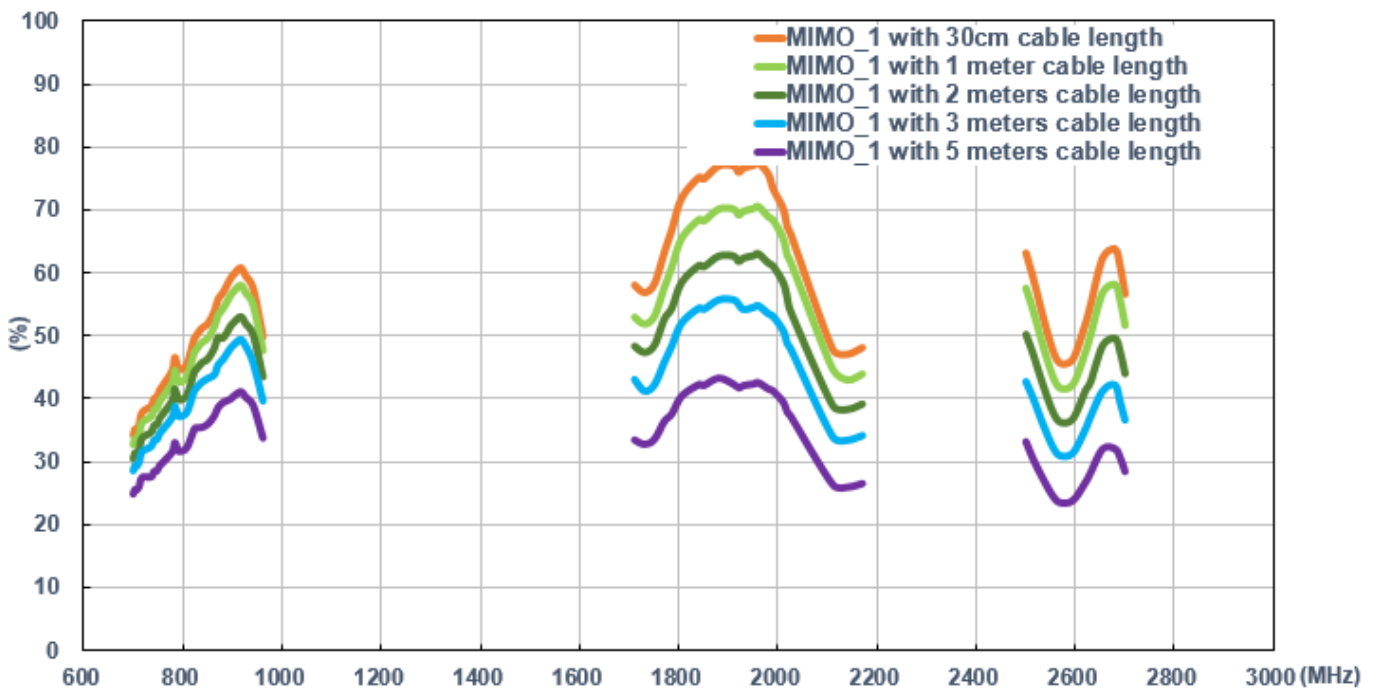

Average Gain

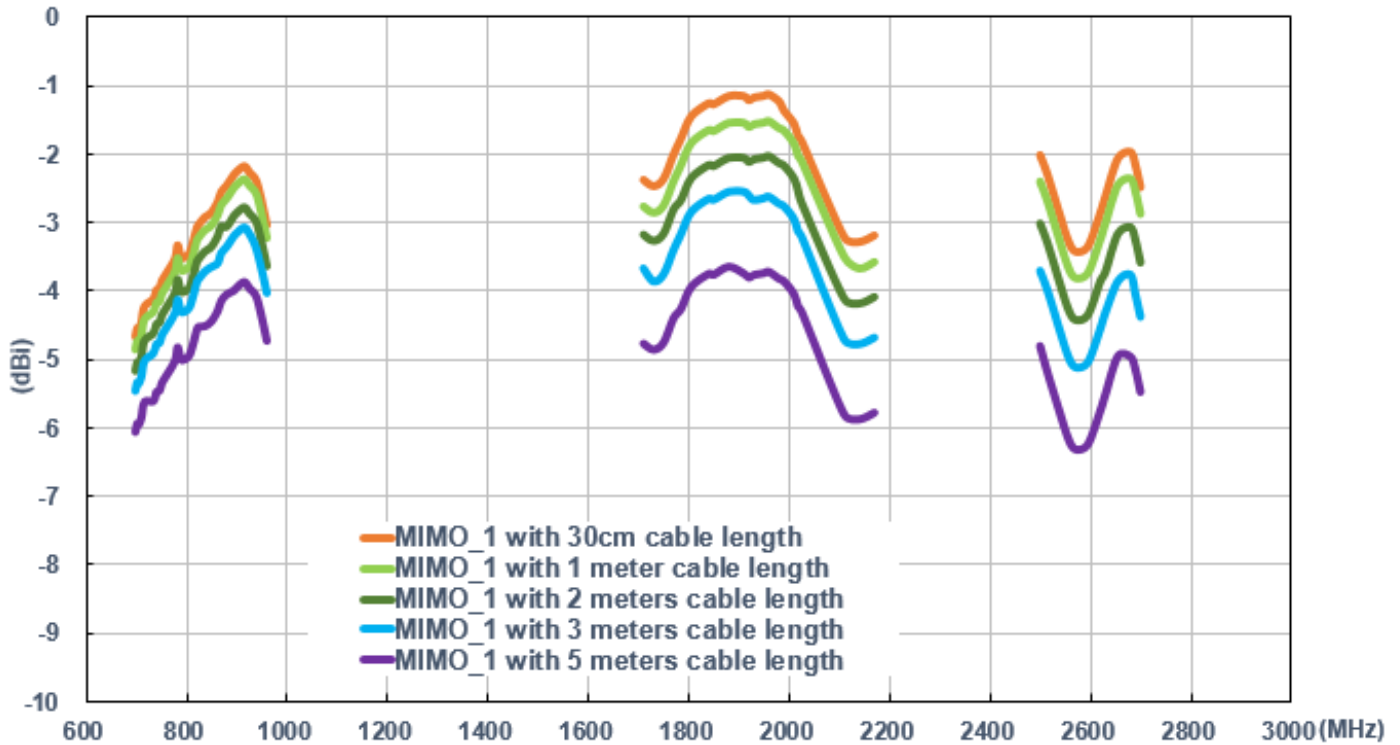

Peak Gain

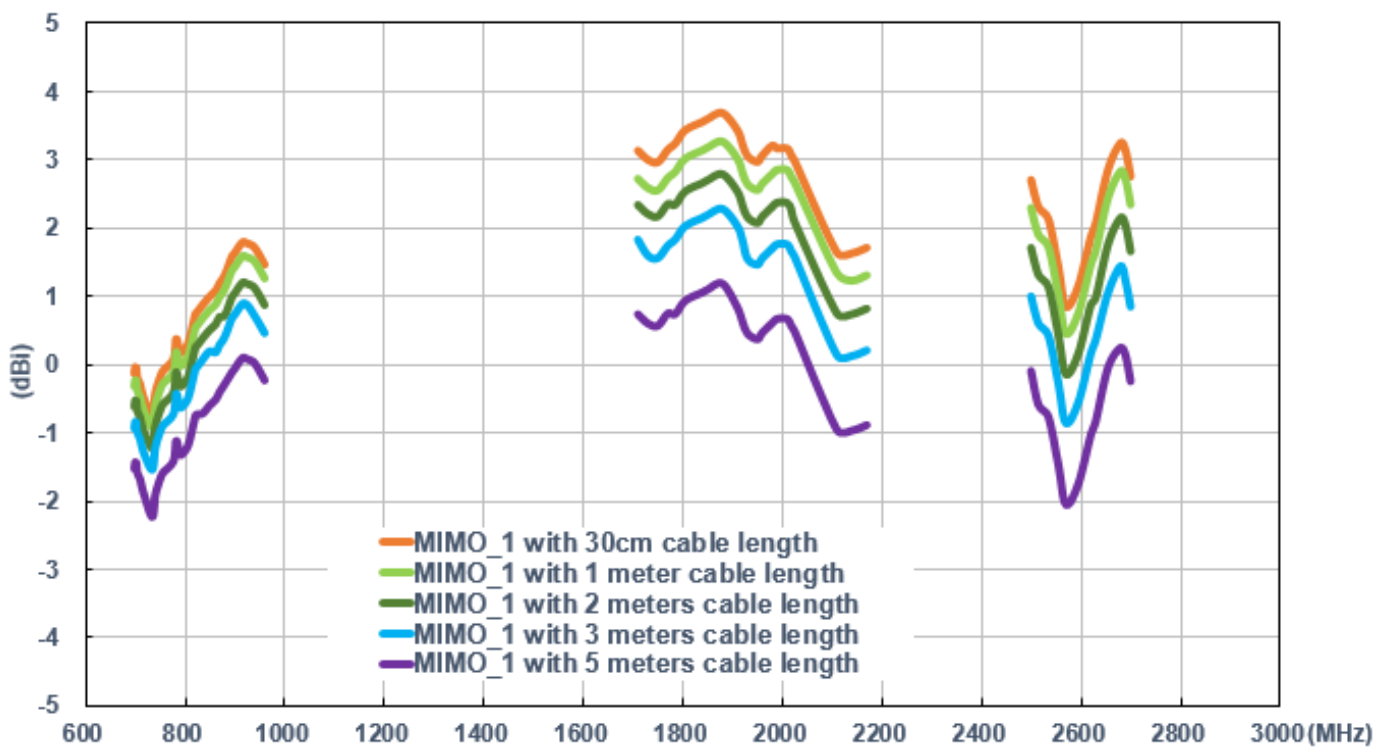

LTE MIMO 2

Return Loss

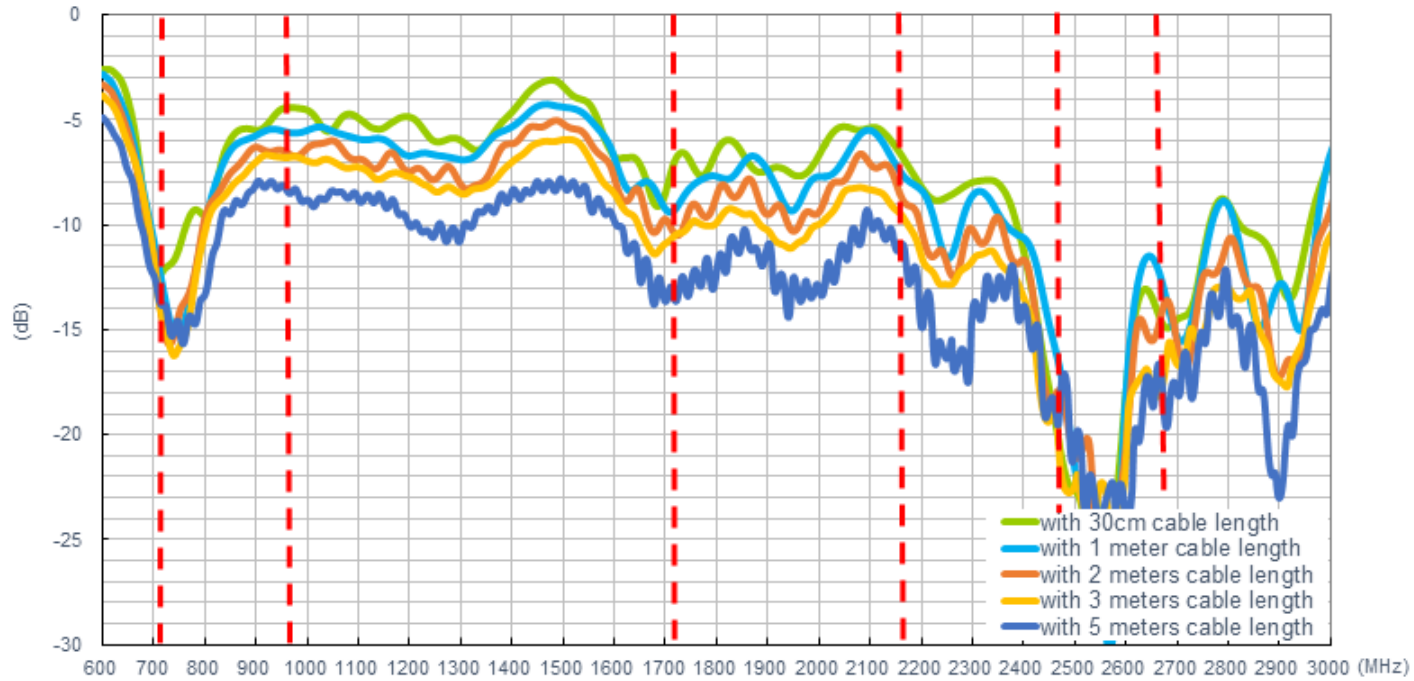

Efficiency

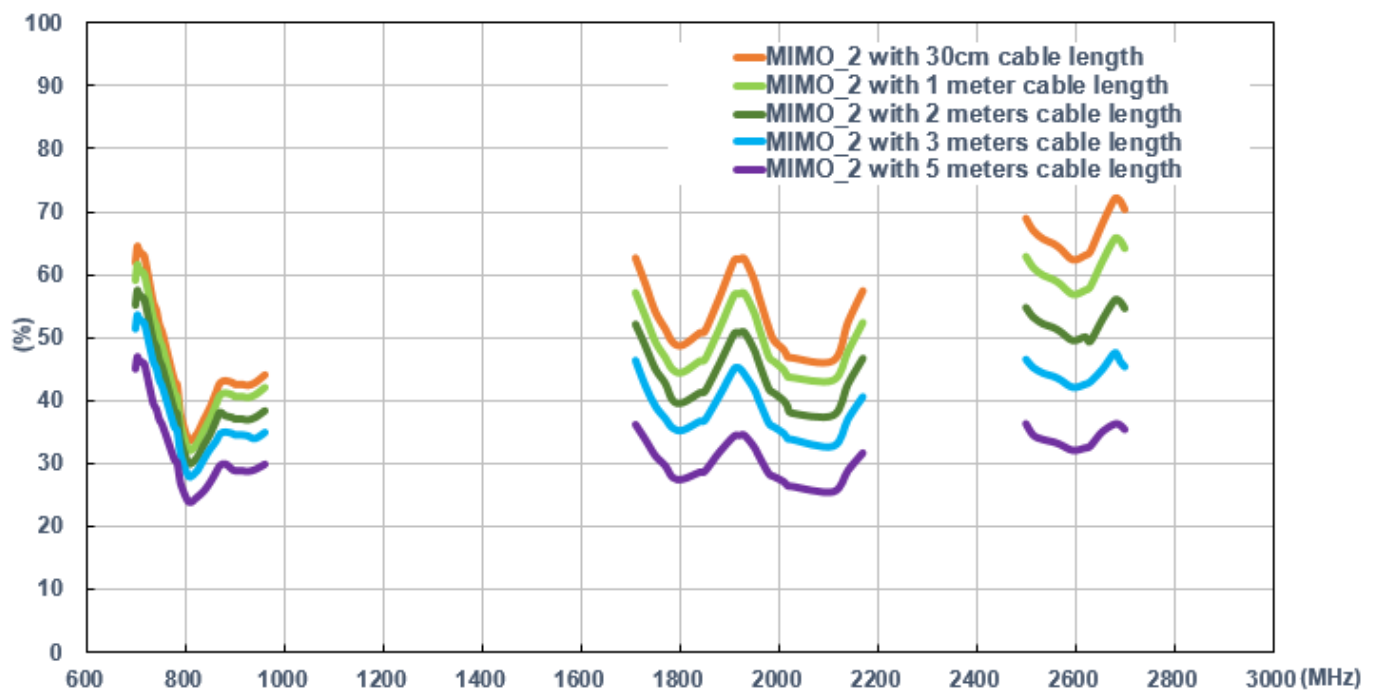

Average Gain

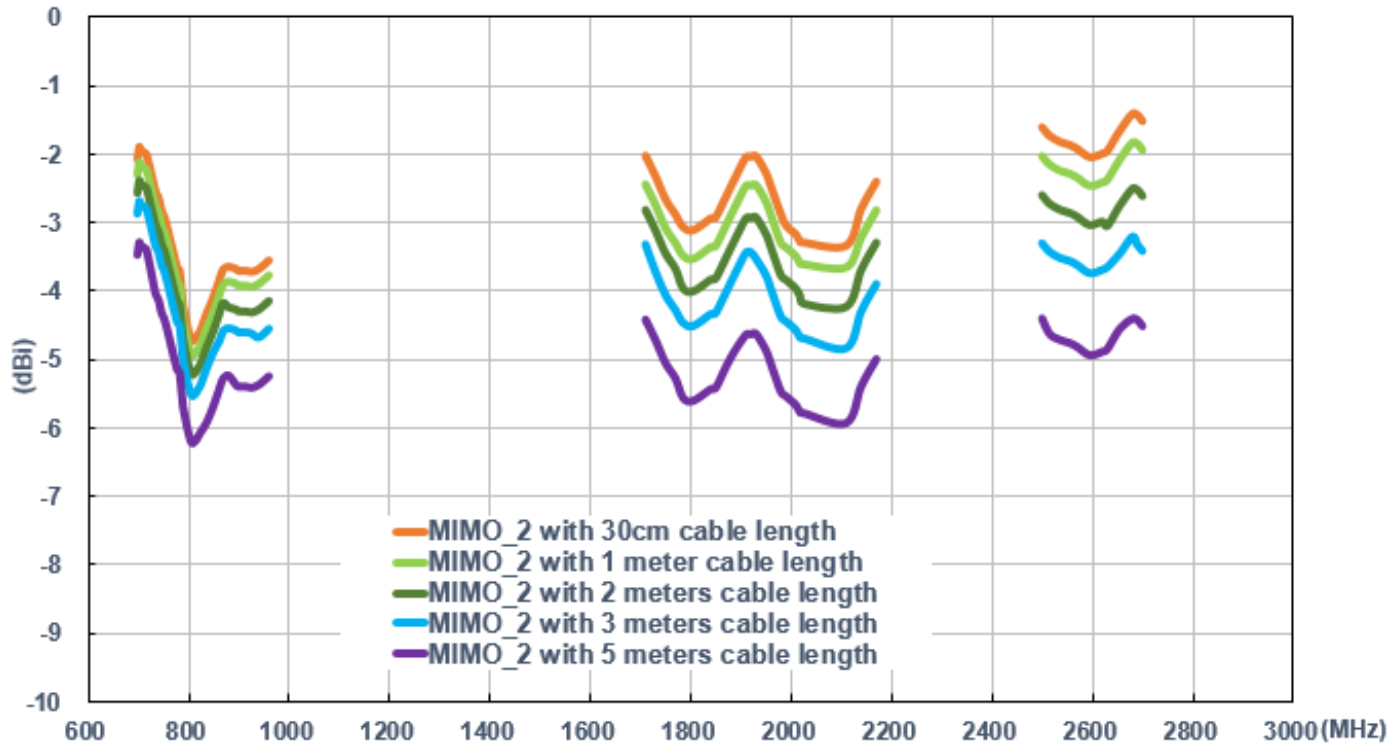

Peak Gain

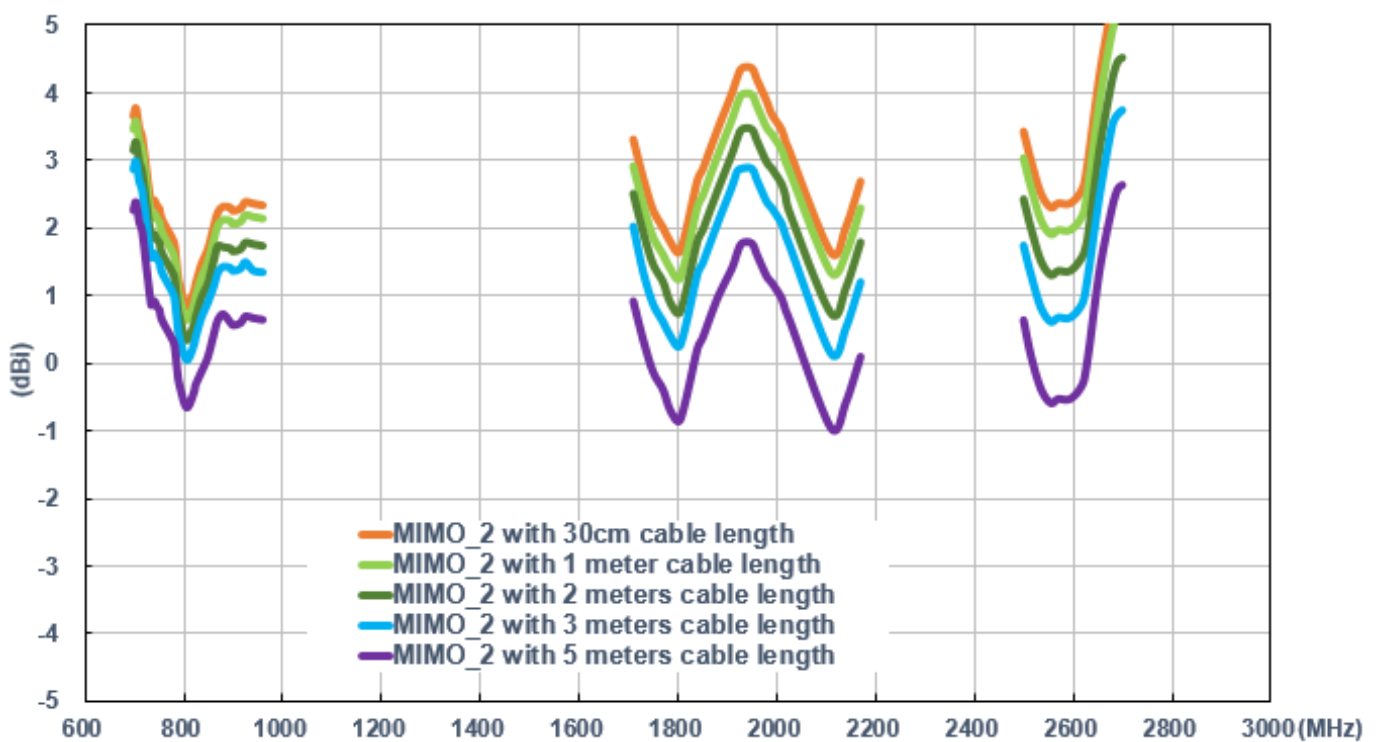

Isolation of MIMO 1 and MIMO 2

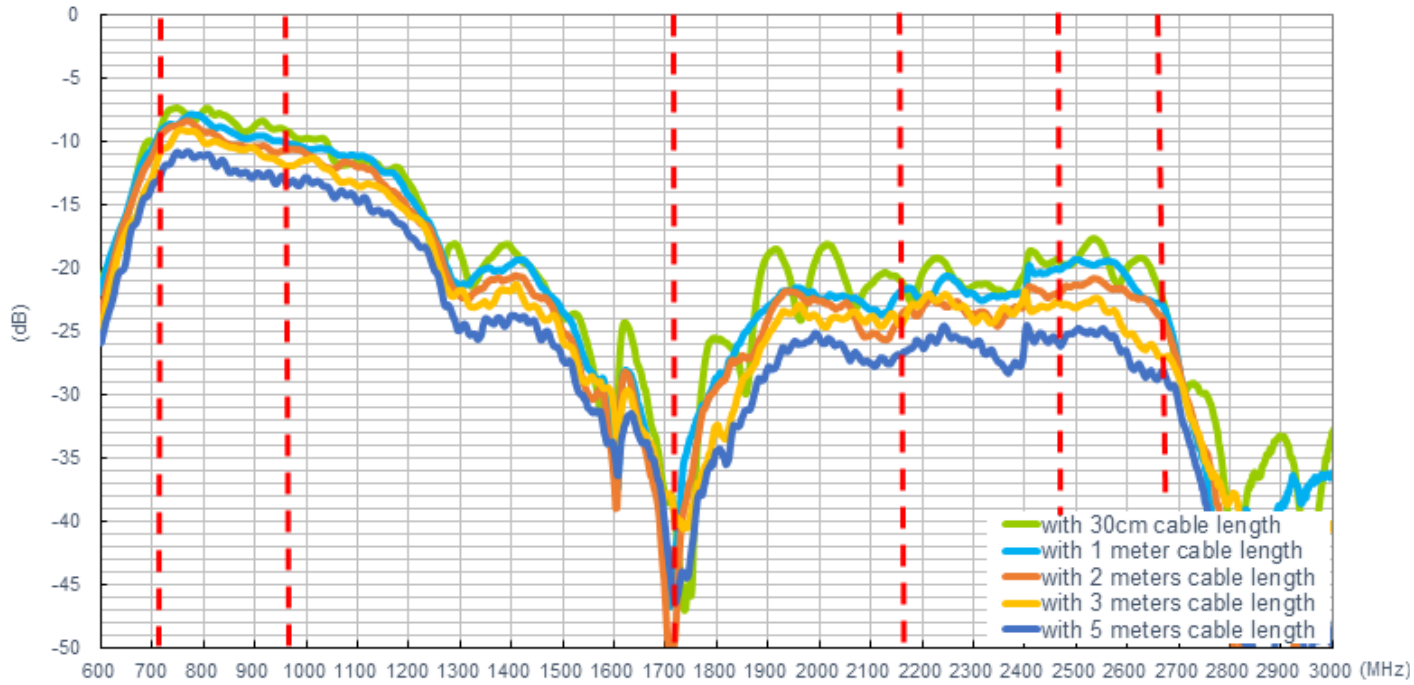

On a glass base

LTE MIMO 1

Return Loss

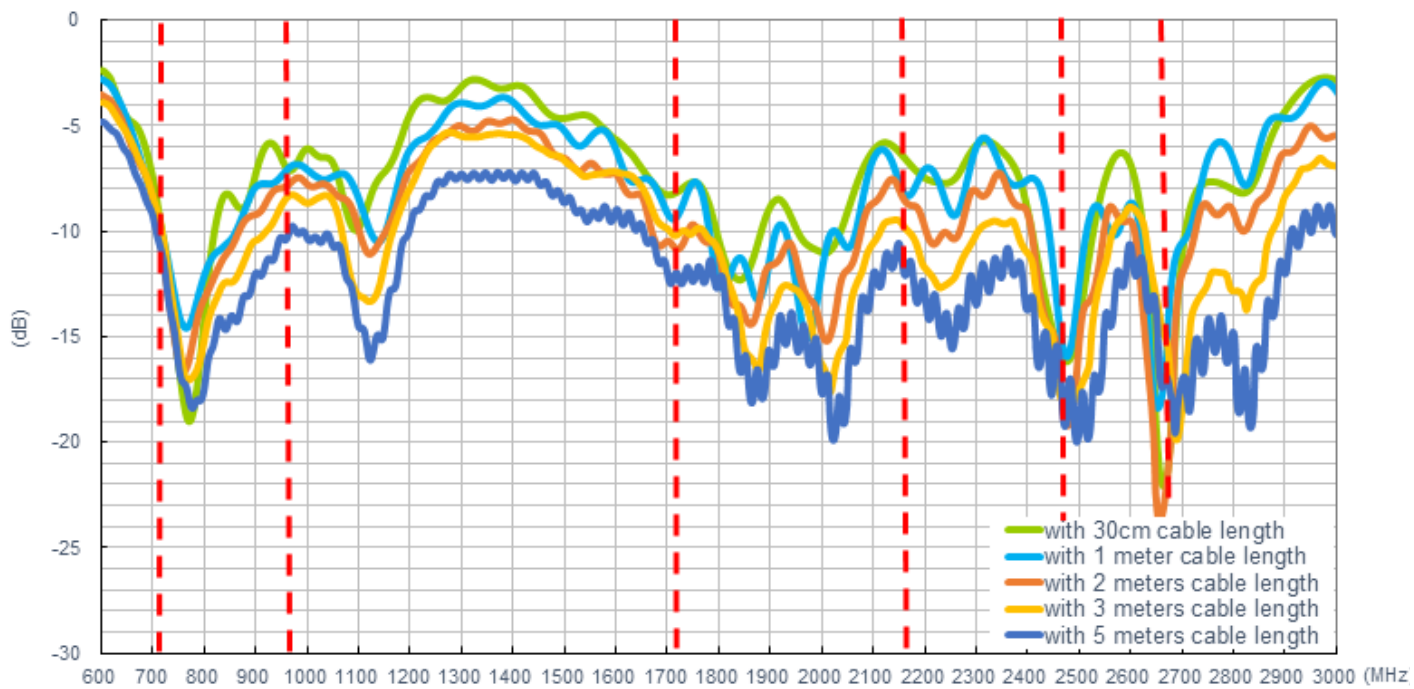

Efficiency

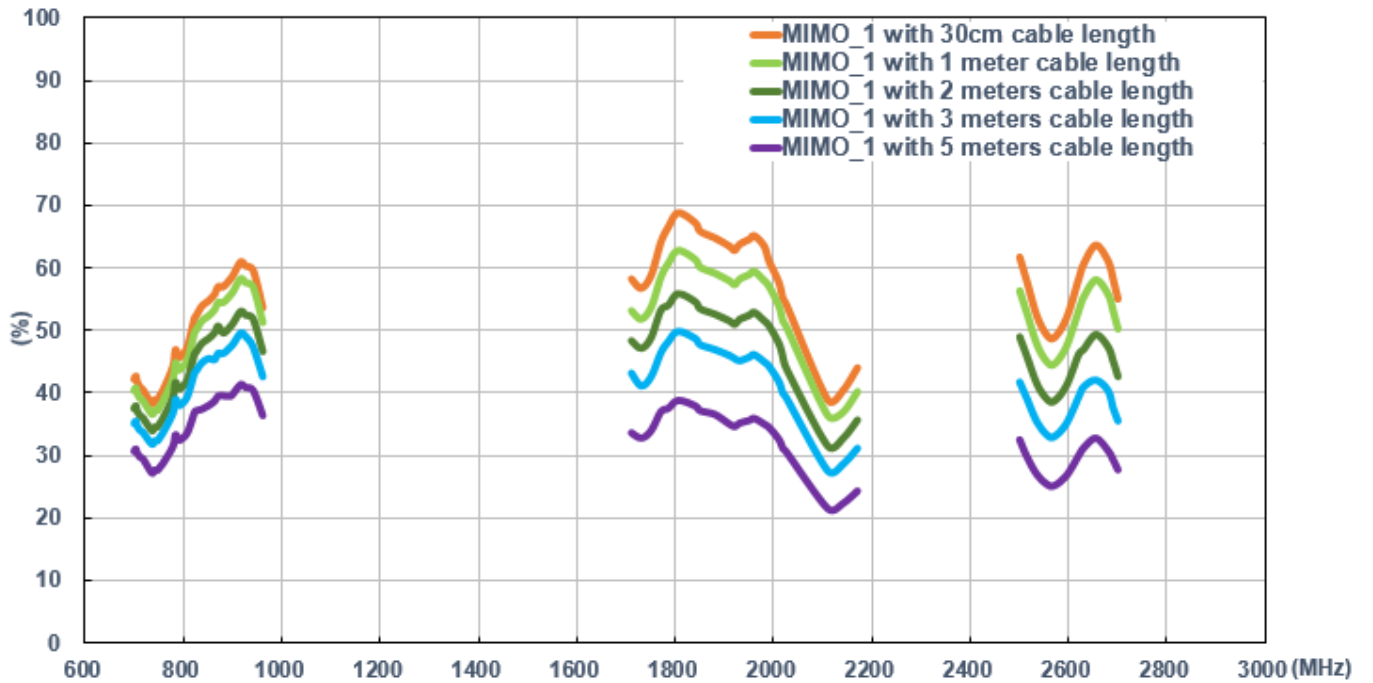

Average Gain

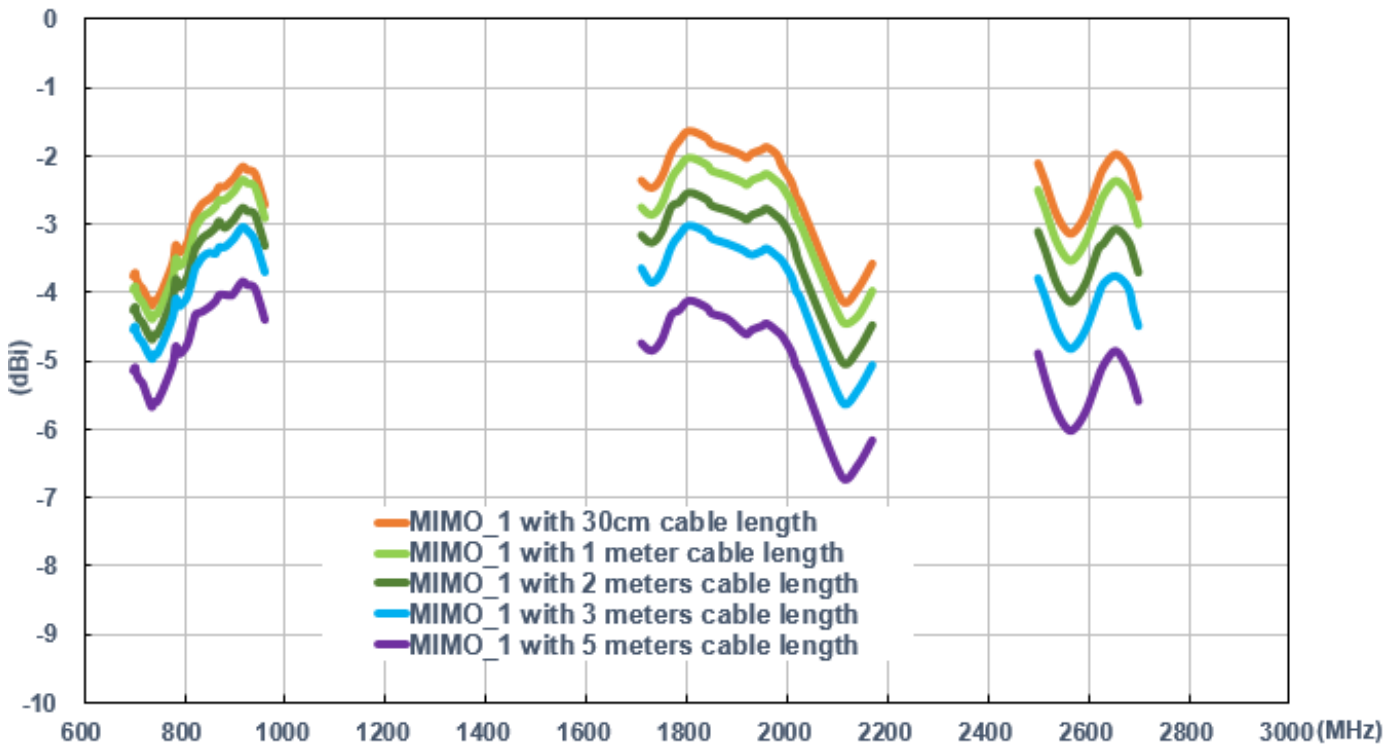

Peak Gain

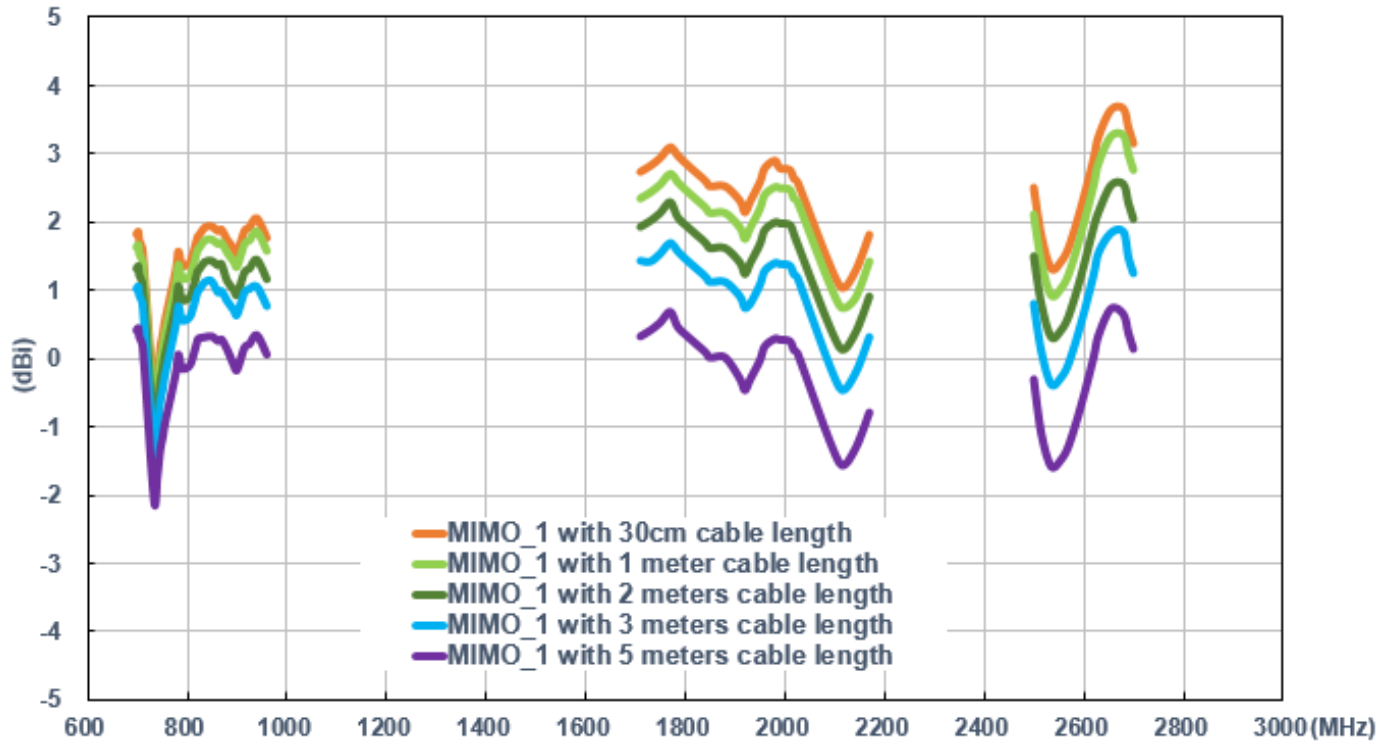

LTE MIMO 2

Return Loss

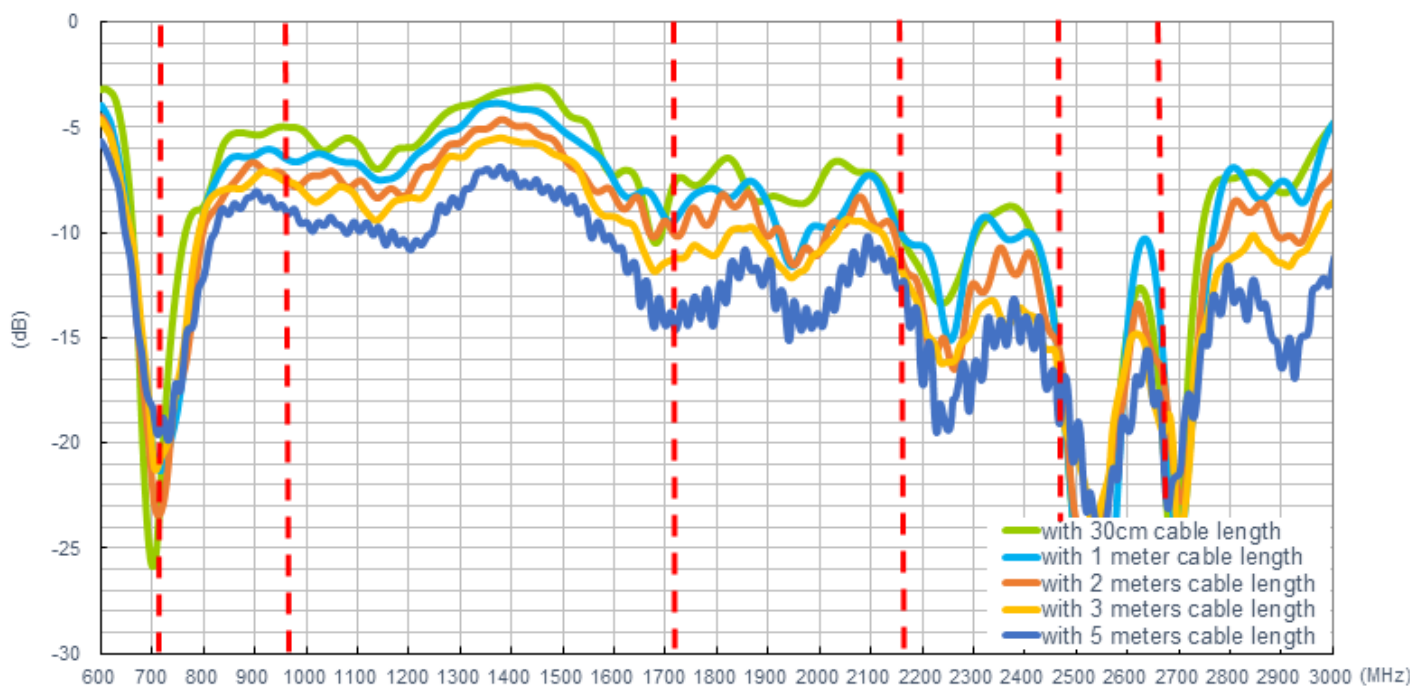

Efficiency

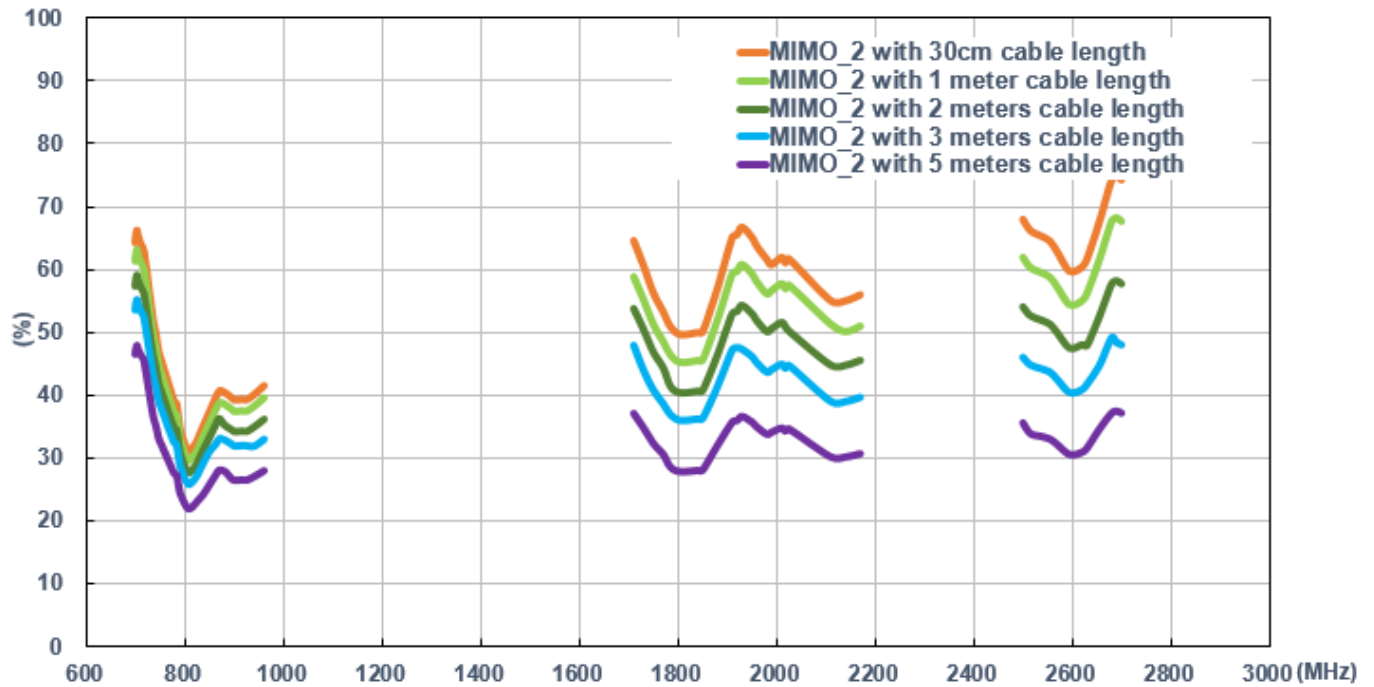

Average Gain

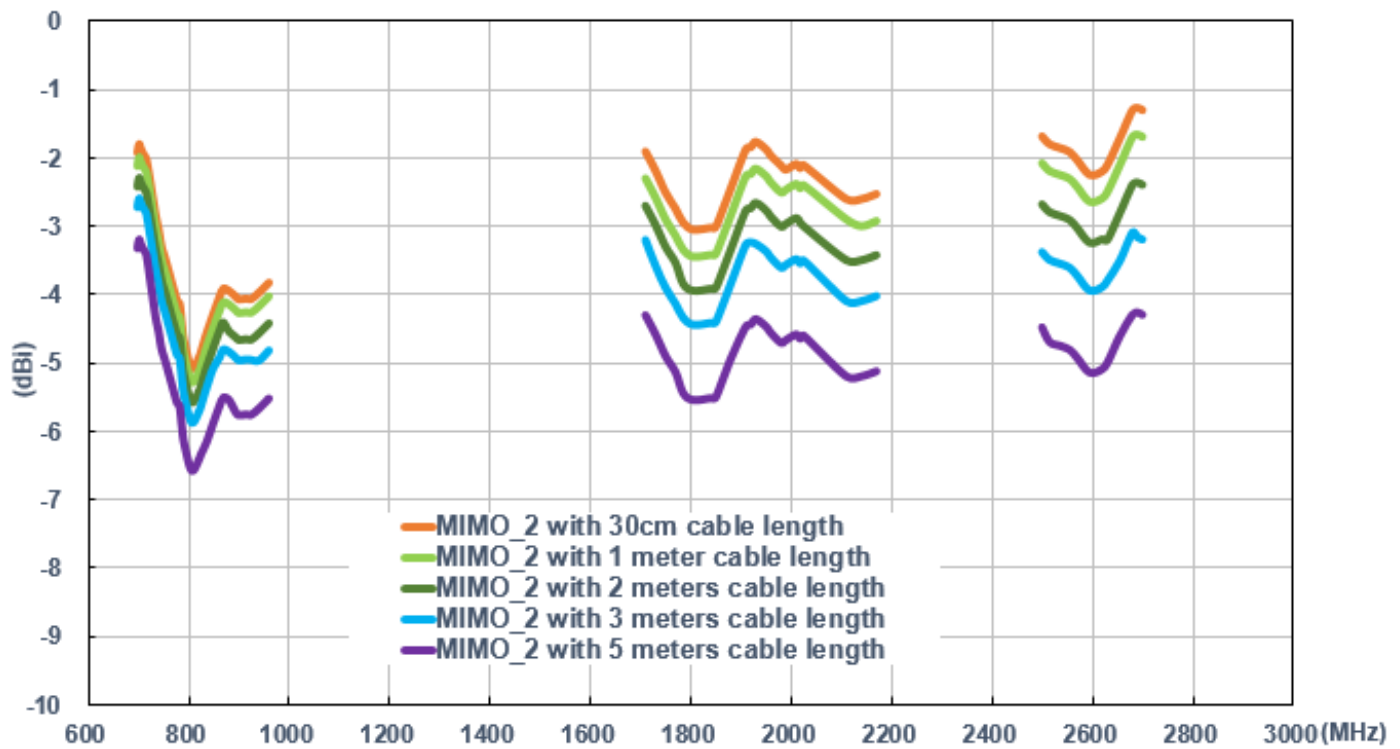

Peak Gain

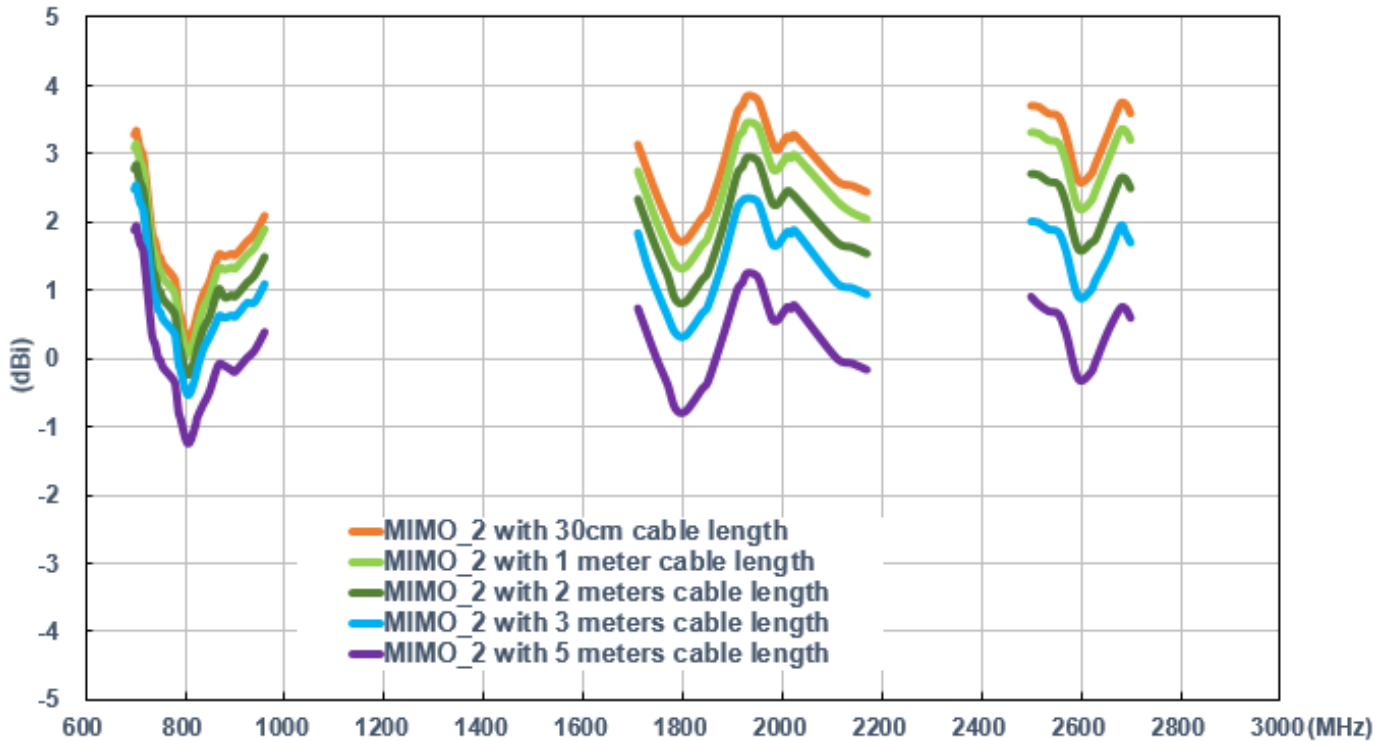

Isolation of MIMO 1 and MIMO 2

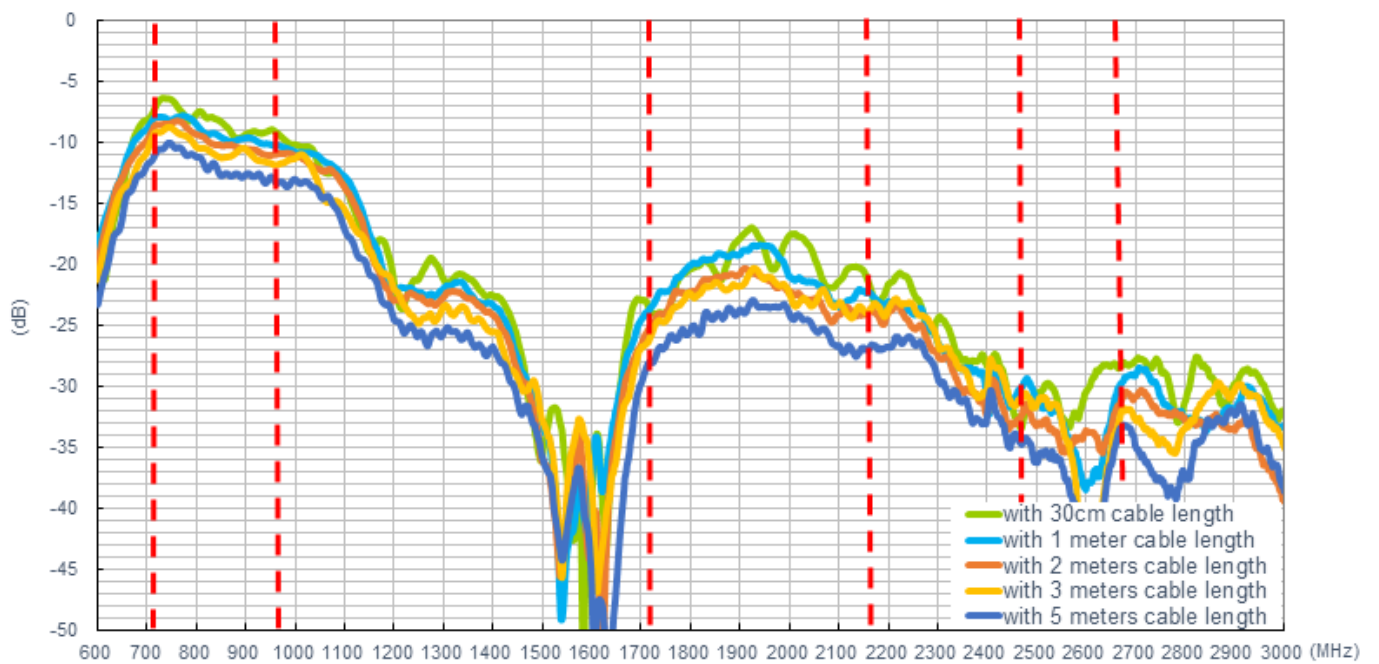



Taoglas makes no warranties based on the accuracy or completeness of the contents of this document and reserves the right to make changes to specifications and product descriptions at any time without notice.

Taoglas reserves the rights to this document and the information contained herein. Reproduction, use or disclosure to third parties without express permission is strictly prohibited.

Copyright © Taoglas Ltd.