

Evaluation Board for the [ADA4530-1](#) 8-Lead SOIC Package

FEATURES

- Footprint for [ADA4530-1](#) 8-lead SOIC package
- Footprints for passive components
- Available in buffer or transimpedance configuration
- Easy modifications to other standard configurations
- Guard ring to minimize leakage current
- Assembled with metal shields
- Enables quick prototyping
- Easy connection to test equipment

GENERAL DESCRIPTION

The [ADA4530-1R-EBZ](#) is an evaluation board for the [ADA4530-1](#) offered in an 8-lead SOIC package. The [ADA4530-1R-EBZ](#) is a 4-layer printed circuit board (PCB) designed to minimize leakage currents with its guard ring features for femtoampere input bias current (I_B) measurement.

The [ADA4530-1R-EBZ](#) is available in two default configurations: buffer ([ADA4530-1R-EBZ-BUF](#)) and transimpedance ([ADA4530-1R-EBZ-TIA](#)). Both boards are populated with the necessary passive components, banana jacks/terminal blocks for supply voltages, BNC/terminal blocks for the output voltage, multiple test pins, and metal shields. All components are placed on the primary side with the exception of the triaxial (triax)/coaxial (coax) input connector (J1) and SHIELD3.

The [ADA4530-1R-EBZ](#) also has unpopulated resistor and capacitor pads that allows quick prototyping with different configurations, such as noninverting gain and inverting gain.

Specifications for the [ADA4530-1](#) are provided in the [ADA4530-1](#) data sheet available from Analog Devices, Inc. The [ADA4530-1](#) data sheet and the [AN-1373 Application Note](#) should be consulted in conjunction with this user guide when using the evaluation board.

Figure 1 shows the top view of the evaluation board, and Figure 2 shows the bottom view. For more views of the evaluation board images, see the [ADA4530-1R-EBZ Evaluation Board Photographs](#) section.

EVALUATION BOARD PHOTOGRAPHS

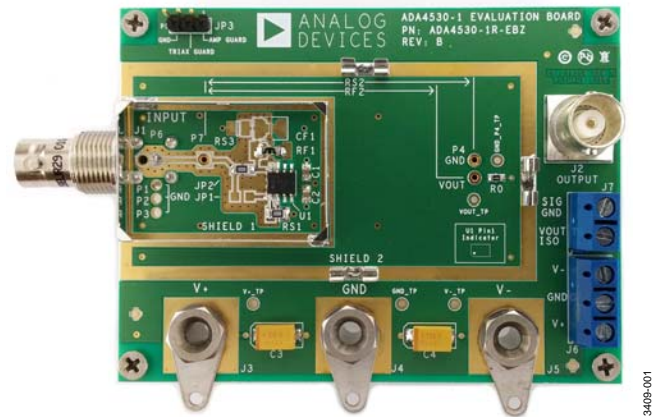

Figure 1. [ADA4530-1R-EBZ](#) Top View



Figure 2. [ADA4530-1R-EBZ](#) Bottom View

TABLE OF CONTENTS

Features	1	Buffer with Triax Guard Driven by Amp Guard.....	6
General Description	1	Buffer with Resistor at IN+ to Ground.....	7
Evaluation Board Photographs	1	Noninverting Gain	7
Revision History	2	Transimpedance with 10 GΩ SMT Feedback Resistor and IN+ Connected to Ground (ADA4530-1R-EBZ-TIA).....	8
Hardware Components.....	3	Transimpedance with Through Hole Feedback Resistor	8
Board Assembly.....	3	Transimpedance with Direct Sensor Connection.....	9
Input, Output, and Supplies	3	Inverting Gain.....	9
Guard and Shield.....	3	ADA4530-1R-EBZ Evaluation Board Photographs.....	10
Board Layers Stackup.....	4	Evaluation Board Schematics.....	11
Cleaning and Handling.....	5	Ordering Information.....	13
Amplifier Configurations	6	Bill of Materials.....	13
Buffer with Triax Guard Externally Driven (ADA4530-1R-EBZ-BUF).....	6		

REVISION HISTORY

10/15—Revision 0: Initial Version

HARDWARE COMPONENTS

BOARD ASSEMBLY

The [ADA4530-1R-EBZ](#) evaluation board is available in two default configurations:

- [ADA4530-1R-EBZ-BUF](#): amplifier is populated in buffer configuration
- [ADA4530-1R-EBZ-TIA](#): amplifier is populated in transimpedance configuration

Both evaluation boards are pre-assembled with necessary components, except for SHIELD2. SHIELD2 is included in the kit, but not installed.

See the Amplifier Configurations section for all other possible configurations.

INPUT, OUTPUT, AND SUPPLIES

[ADA4530-1R-EBZ-TIA](#) is populated with an input BNC connector (J1) that connects to the amplifier inverting pin through JP2.

[ADA4530-1R-EBZ-BUF](#) is populated with an input triax connector (J1). The inner conductor of J1 is the high impedance connection through JP1 to the noninverting pin of the [ADA4530-1](#). The inner braided shield is a guard; the driving source is configured with JP3. The outer braided shield is the signal return; it is connected to GND.

The evaluation board uses JP3 to select the driving source of the triax guard. Table 1 shows the three different configurations of JP3.

Table 1. JP3 Configuration

JP3	Description
Unconnected	Triax guard is externally driven. This configuration is used when the guard is driven by an external test equipment, such as a picoammeter. This configuration is also by default on both the ADA4530-1R-EBZ-TIA and ADA4530-1R-EBZ-BUF boards.
Short TRIAX GUARD to AMP GUARD	Triax guard is driven by the ADA4530-1 guard buffer. This configuration is useful if the ADA4530-1R-EBZ-BUF is connected to a passive sensor.
Short TRIAX GUARD to GND	Triax guard is connected to signal ground. This configuration is useful when the amplifier is in transimpedance configuration with the noninverting pin connected to signal ground.

The evaluation board output can be measured with two different options:

1. BNC connector (J2) allows BNC cabling
2. Terminal block (J7) allows wire-to-board connection

A VOUT_TP test point is also provided.

R_o isolates the output load from the amplifier output to prevent any oscillation from excessive capacitive loading. A 499 Ω resistor is mounted on-board.

Power supplies to the board can be applied in two different ways:

1. V+ (J3), GND (J4), and V- (J5) allow banana plugs to be used
2. Terminal block (J6) allows wire-to-board connection

V+_TP, GND_TP, and V-_TP test points are provided.

GUARD AND SHIELD

The [ADA4530-1R-EBZ](#) board uses guard rings, a guard plane, and a via fence to entirely guard the high impedance input traces against leakage current. On the top layer, the guard ring encircle the inverting and noninverting input components (see Figure 3). Guard via fences from the top layer to bottom layer are also used to encircle the high impedance inputs to prevent leakage currents from inner layers of the board. For more information on the physical implementation of guarding techniques, see the [ADA4530-1](#) data sheet.

The copper shield traces, SHIELD1, SHIELD2, and SHIELD3 allow soldered metal shields to enclose the high impedance inputs as a means to avoid electrostatic interference. The shield traces are electrically connected to the amplifier guard potential.

SHIELD1 and SHIELD3 are 1 inch × 1.5 inch × 0.25 inch metal shields and are pre-assembled on board. There is a high impedance pin socket (P7) that goes through the bottom of the board, and hence SHIELD3 is populated at the bottom of the board. Other than providing electrostatic shielding, the shields also prevent contamination from fingerprints, dust, and other contaminants to the high impedance inputs.

SHIELD2 is a 1.5 inch × 3 inch × 0.75 inch metal shield and is provided separately with the evaluation board. It is used when large through hole resistors are populated on board. RF clips are assembled to hold the shield in place. Note that it is sufficient to remove the SHIELD1 cover, without needing to desolder SHIELD1, to accommodate SHIELD2 when large through hole resistors are used.

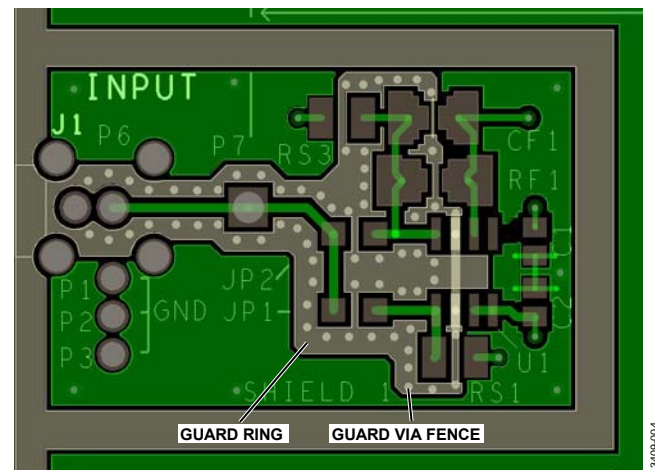

Figure 3. Guarding

BOARD LAYERS STACKUP

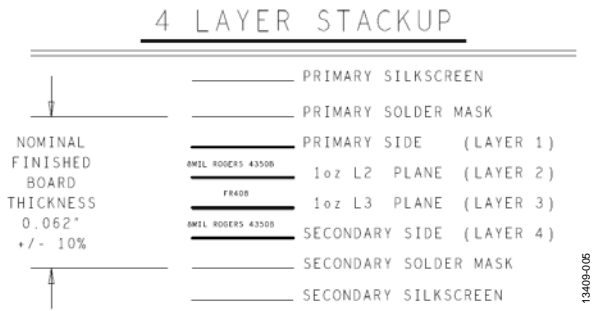

Figure 4. Board Layer Stackup

The [ADA4530-1R-EBZ](#) is a 4-layer evaluation board that uses the Rogers 4350B, a high performance PCB laminate. A hybrid stackup is required for mechanical strength. The top and bottom layers are ceramic (Rogers 4350B) while the middle core layer is a conventional glass epoxy laminate (FR-4). The Rogers 4350B material provides superior insulation resistance in the presence of humidity compared to glass/epoxy materials. It minimizes current leakage and, therefore, increases signal integrity. Additionally, the dielectric relaxation times of Rogers 4350B are much shorter than glass/epoxy dielectrics. For more information on dielectric relaxation, see the [ADA4530-1](#) data sheet.

CLEANING AND HANDLING

It is important to always handle the board by the edges and never touch the area within SHIELD1.

Before using the board, properly clean the evaluation board to remove any contaminants, such as solder flux, saline moisture, dirt, and dust, to maintain its low leakage performance. Any contaminants can severely degrade its femtoampere performance. The board must also be cleaned again after any rework to the components.

An effective cleaning procedure consists of the following steps:

1. Soak the board in an ultrasonic bath with cleanroom grade isopropyl alcohol for 15 minutes. Ultrasonic cleaning uses ultrasound at a high frequency, creating cavitation in the cleaning solution. This process helps to remove contaminants on the surface of the board and in areas under soldered components that are hard to reach. The next cleaning steps require using fresh isopropyl alcohol.
2. Remove the board from the ultrasonic bath with a pair of forceps. Rinse and flush the board with isopropyl alcohol to remove any contaminant residue.
3. Flood the board with isopropyl alcohol and gently scrub it with an acid brush. Concentrate on areas between the U1 pins, the input traces to J1, the guard ring, and the area within SHIELD1.
4. Rinse and flush the board with isopropyl alcohol.
5. Repeat Step 3 and Step 4 for the bottom of the board.
6. Give a final flush for the top and bottom of the board with isopropyl alcohol.
7. Use compressed dry air to dry the board. Blow air around the U1 pins, the input traces to J1, and the guard ring area. Be sure to direct the compressed air under J1 and U1 as well.
8. To make sure that the board is completely dry, bake the board in the oven at 125°C for 15 minutes.
9. After cleaning, remember to place the cover of the metal shield on both sides of the board. The metal shields help prevent any contact to the guarded area.

AMPLIFIER CONFIGURATIONS

This section describes the different configurations possible with the evaluation board. For some configurations, remove stated pre-assembled components to allow assembly of new components of choice. After any rework, the evaluation board must be cleaned according to the Cleaning and Handling section.

BUFFER WITH TRIAX GUARD EXTERNALLY DRIVEN (ADA4530-1R-EBZ-BUF)

The amplifier on this evaluation board is defaulted to a buffer configuration. An input signal can be applied through the triax connector, J1. Note that JP3 is left unconnected by default so that the triax guard can be driven by external test equipment. For direct input bias current (I_B) measurement, connect an electrometer such as the Keithley 6430 to the board via J1. The Keithley 6430 internal guard buffer drives the triax guard (see Figure 5 and Figure 6 for the configuration). Details regarding I_B measurement are described in the AN-1373 Application Note.

Table 2. Buffer with Triax Guard Externally Driven Pad/Connector Configuration

Pad/Connector	Description
JP1	0 Ω
JP3	Unconnected
RF1	0 Ω

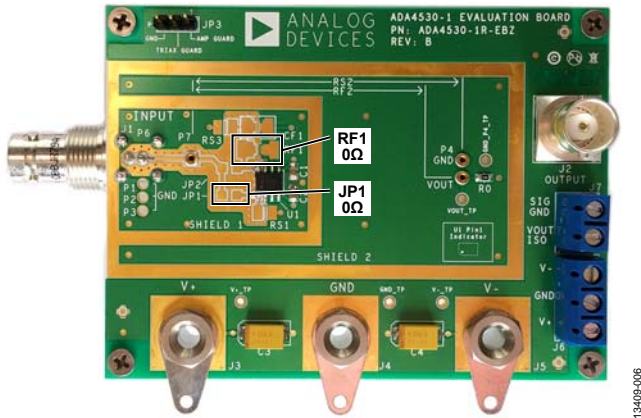

Figure 5. Buffer with Triax Guard Externally Driven

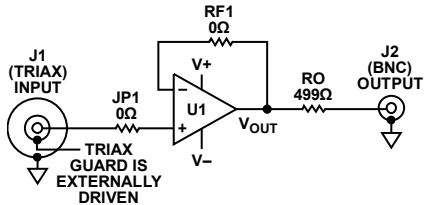

Figure 6. Buffer with Triax Guard Externally Driven Schematic

BUFFER WITH TRIAX GUARD DRIVEN BY AMP GUARD

For a buffer configuration where the triax guard is not driven by any external test equipment, TRIAX GUARD must be shorted to AMP GUARD via JP3. This configuration is useful when the buffer is connected to a passive sensor (or an input signal).

Table 3 shows the recommended component values.

Table 3. Buffer with Triax Guard Driven by Amp Guard Pad/Connector Configuration¹

Pad/Connector	Description
JP1	0 Ω
JP3	Short TRIAX GUARD to AMP GUARD
RF1	0 Ω

¹ Use the ADA4530-1R-EBZ-BUF board.



Figure 7. Buffer with Triax Guard Driven by Amp Guard

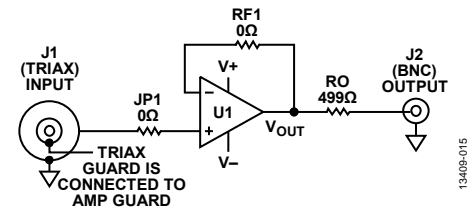

Figure 8. Buffer with Triax Guard Driven by Amp Guard Schematic

BUFFER WITH RESISTOR AT IN+ TO GROUND

To configure the DUT as a buffer with a large resistor at the noninverting pin to ground, use the ADA4530-1R-EBZ-BUF evaluation board and remove JP1. Large value, through hole resistors (RS2) can be placed between the noninverting pin and ground using the P7 and P4 pin sockets. Place one end of the leaded resistor at P7 and the other end at P4 (GND). If an SMT resistor is used, use the RS1 pad instead. The RS1 pad allows the assembly of a 1206 or 1210 package size resistor. This configuration allows the user to measure I_{B+} , where $V_{OUT} = I_{B+} \times RS1$ or $V_{OUT} = I_{B+} \times RS2$.

Table 4. Buffer with Resistor at IN+ to Ground Pad Configuration¹

Pad	Description
JP1	0 Ω
JP3	Unconnected
RF1	0 Ω
RS1 ²	Used for a SMT source resistor
RS2 ²	Used for a through hole source resistor

¹ Use the ADA4530-1R-EBZ-BUF board.
² Assemble either RS1 or RS2.

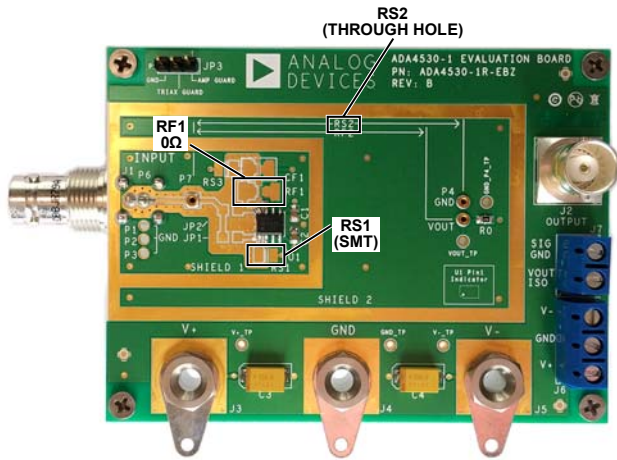

Figure 9. Buffer with Resistor at IN+ to Ground

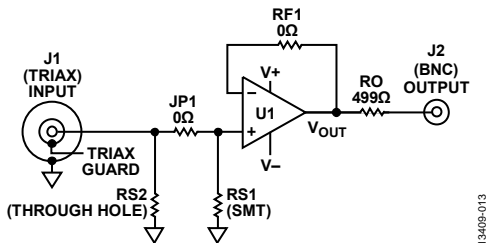

Figure 10. Buffer with Resistor at IN+ to Ground Schematic

NONINVERTING GAIN

To configure the ADA4530-1 in a noninverting gain, use the components shown in Table 5. Choose appropriate RF1 and RS3 values for the desired gain. Note that the pre-assembled RF1 must be replaced with a resistor of choice.

Table 5. Noninverting Gain Pad/Connector Configuration¹

Pad/Connector	Description
JP1	0 Ω
JP3	Short TRIAX GUARD to AMP GUARD
RF1	Replace 0 Ω resistor with resistor of choice
RS3	Populate with resistor of choice

¹ Use the ADA4530-1R-EBZ-BUF board.

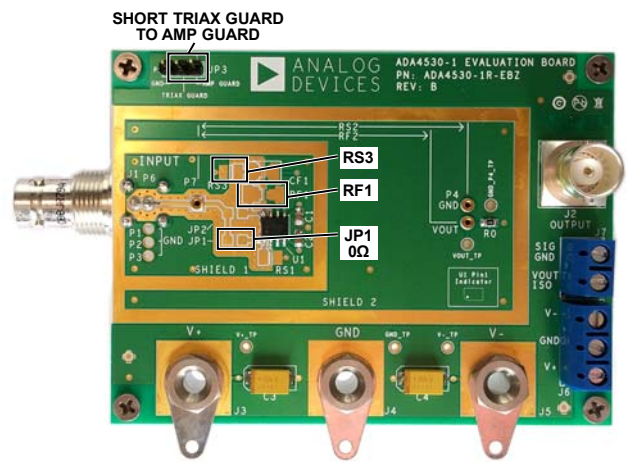

Figure 11. Noninverting Gain

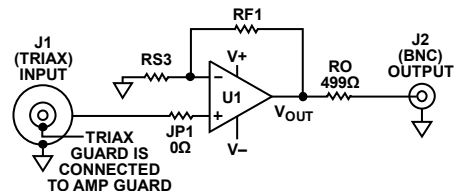

Figure 12. Noninverting Gain Schematic

TRANSIMPEDANCE WITH 10 GΩ SMT FEEDBACK RESISTOR AND IN+ CONNECTED TO GROUND (ADA4530-1R-EBZ-TIA)

On the ADA4530-1R-EBZ-TIA board, the amplifier is defaulted to a transimpedance configuration. The transimpedance configuration is a current-to-voltage (I to V) converter. A 10 GΩ SMT 1206 package size feedback resistor (RF1) is pre-assembled on board. If other resistor values or package sizes are needed, the 10 GΩ feedback resistor can be desoldered to allow the assembly for the SMT resistor of choice. The evaluation board provides a combination footprint that allows assembly of either an 0805, 1206, 1210, 2510, or 2512 package size for RF1.

Larger value through hole feedback resistors, in the order of high gigaohms or teraohms, are also often used in a transimpedance application. This option is discussed in the Transimpedance with Through Hole Feedback Resistor section.

Table 6. Transimpedance with 10 GΩ SMT Feedback Resistor and IN+ Connected to Ground Pad/Connector Configuration

Pad/Connector	Description
JP2	0 Ω
JP3	Unconnected
RF1	10 GΩ
RS1	0 Ω

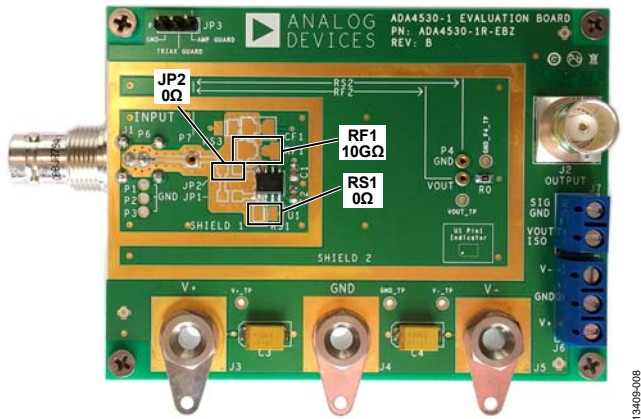

Figure 13. Transimpedance with 10 GΩ Feedback and IN+ Connected to Ground

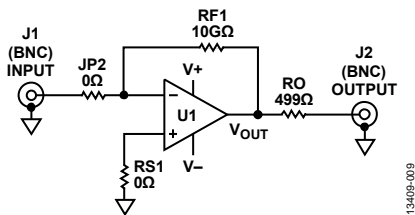

Figure 14. Transimpedance with 10 GΩ Feedback and IN+ Connected to Ground Schematic

TRANSIMPEDANCE WITH THROUGH HOLE FEEDBACK RESISTOR

In a transimpedance configuration, larger value through hole feedback resistors, in the order of high gigaohms or teraohms, are often used. These resistors are glass encapsulated and hermetically sealed, and come in large footprints. An example of this is the Ohmite RX-1M ultrahigh resistance, high stability, hermetically sealed resistor.

To cater to its large footprint, pin sockets (P7 and VOUT) are provided for RF2. Place one end of the leaded resistor at P7 and the other end at VOUT. Note that when using the evaluation board for this configuration, use the ADA4530-1R-EBZ-TIA board and remove the pre-assembled 10 GΩ feedback resistor.

When RF2 is used, remove the cover of SHIELD1 to allow placement of the large through hole resistor. Secure SHIELD3, which is provided with the kit, with the pre-assembled RF clips to provide electrostatic shielding.

Table 7. Transimpedance with Through Hole Feedback Resistor Pad/Connector Configuration¹

Pad/Connector	Description
JP2	0 Ω
JP3	Unconnected
RS1	0 Ω
RF1	Remove from board
RF2	Populate with resistor of choice

¹ Use the ADA4530-1R-EBZ-TIA board.

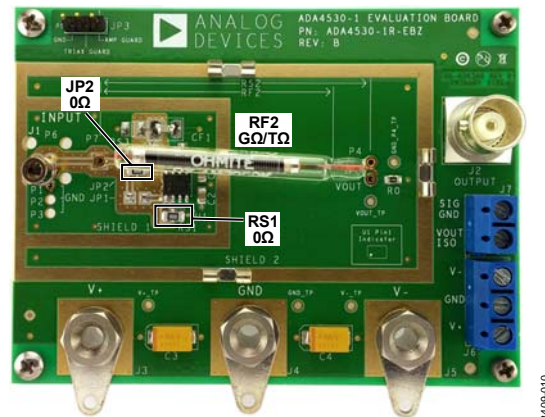

Figure 15. Transimpedance with Through Hole Feedback Resistor

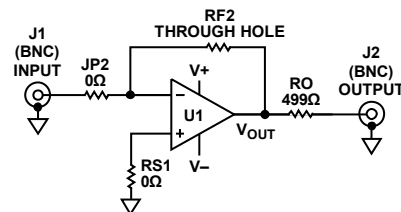

Figure 16. Transimpedance with Through Hole Feedback Resistor Schematic

TRANSIMPEDANCE WITH DIRECT SENSOR CONNECTION

The ADA4530-1R-EBZ-TIA board can be reconfigured to allow direct sensor connection. The P6 and P1, P2, or P3 pins are provided to allow assembly of a photodiode. To reconfigure the board, remove the input BNC connector (J1). The user must then access Pin P6 (the inner conductor pin of the BNC connector). Assemble the photodiode of choice between P6 and P1, P2, or P3. P1, P2, and P3 are electrically connected to signal ground. These three pins are provided to allow different photodiode packages to be used, for example: TO-19, TO-5, or TO-8.

Table 8. Transimpedance with Direct Sensor Connection Pad/Connector Configuration¹

Pad/Connector	Description
CF1	Feedback capacitor ²
J1	Remove J1
JP2	0 Ω
JP3	Unconnected
RS1	0 Ω
RF1 ³	Use pre-assembled 10 GΩ resistor or replace with SMT resistor of choice
RF2 ³	Used with through hole feedback resistor

¹ Use the ADA4530-1R-EBZ-TIA board.
² See the Photodiode Interface section in the ADA4530-1 data sheet on how to select CF1
³ Assemble either RF1 or RF2.

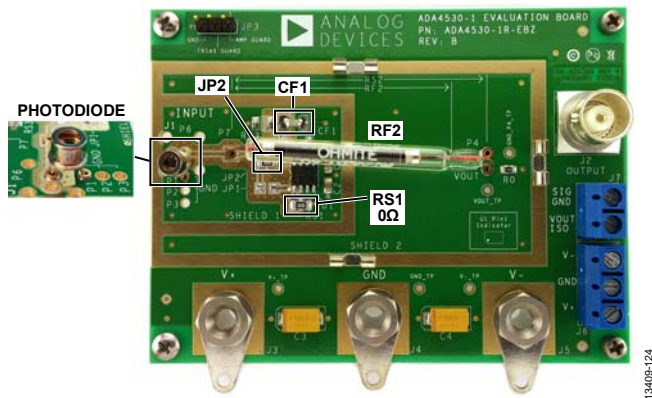

Figure 17. Transimpedance with Direct Sensor Connection

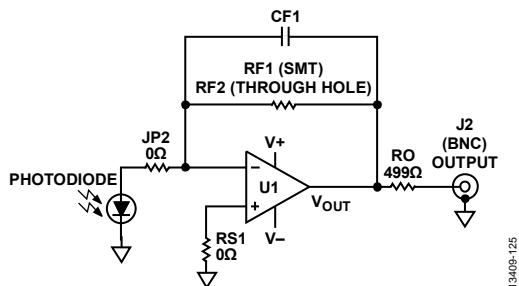

Figure 18. Transimpedance with Direct Sensor Connection Schematic

INVERTING GAIN

To configure the ADA4530-1 in an inverting gain, use the components shown in Table 9. Choose appropriate RF1 and JP2 values for the desired gain.

Table 9. Inverting Gain Pad Configuration¹

Pad	Description
JP2	Populate with resistor of choice
RS1	0 Ω
RF1	Replace 10 GΩ with resistor of choice

¹ Use the ADA4530-1R-EBZ-TIA board.

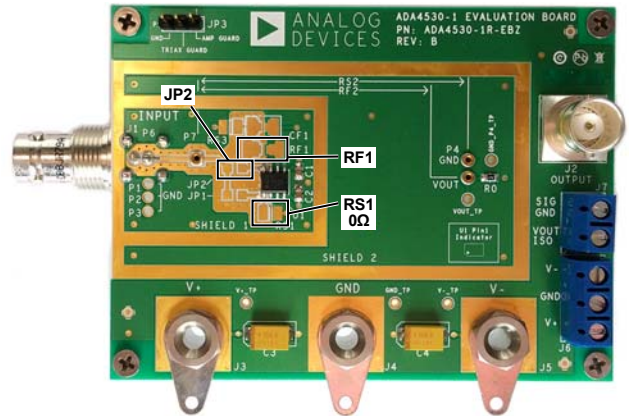

Figure 19. Inverting Gain

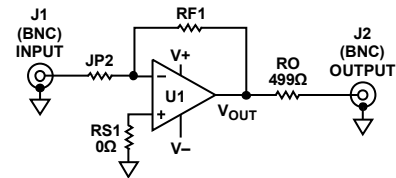

Figure 20. Inverting Gain Schematic

ADA4530-1R-EBZ EVALUATION BOARD PHOTOGRAPHS



13409-002

Figure 21. Evaluation Board Top View with SHIELD1



13409-121

Figure 22. Evaluation Board Bottom View with SHIELD3



13408-122

Figure 23. Evaluation Board Top View with SHIELD2

EVALUATION BOARD SCHEMATICS

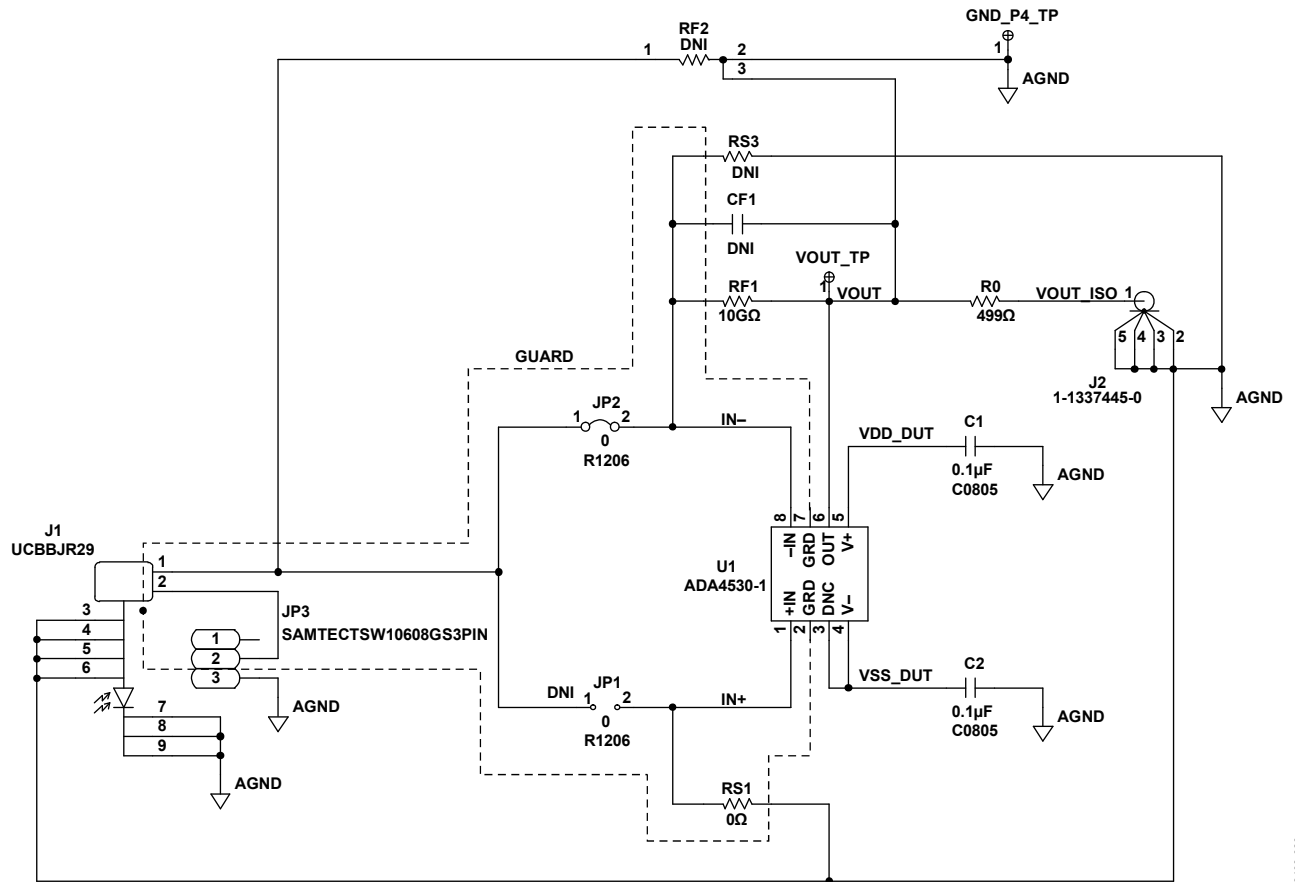

Figure 24. ADA4530-1R-EBZ-TIA Schematic

13409-020

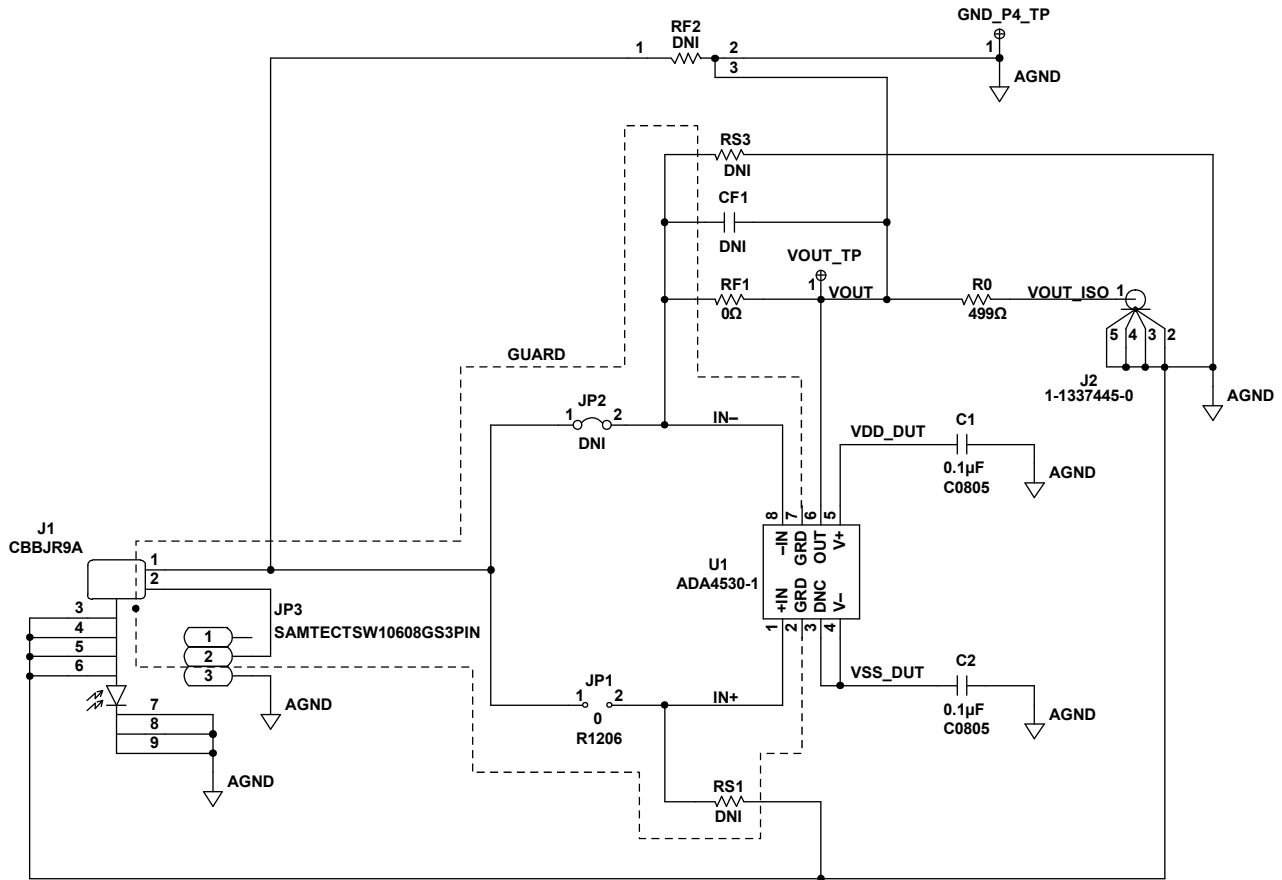

Figure 25. ADA4530-1R-EBZ-BUF Schematic

134/09-021

ORDERING INFORMATION

BILL OF MATERIALS

Table 10. Bill of Materials for ADA4530-1R-EBZ-TIA

Qty	Reference Designator	Description	Manufacturer Part Number	Distributor
1	U1	Femtoampere input bias current electrometer amplifier (device under test)	Analog Devices, Inc., ADA4530-1	
2	C1, C2	0.1 μ F, 50 V, 5%, 0805	Kemet, C0805C104J5RACTU	Digi-Key, 399-1171-6-ND
2	C3, C4	10 μ F, 35 V, 10%, 7343	AVX, TPSD106K035R0125	Digi-Key, 478-3337-2-ND
1	RO	499 Ω , 0.125 W, 1%, 0805	Panasonic, ERJ-6ENF4990V	Digi-Key, P499CCT-ND
2	RS1, JP2	0 Ω , 0.25 W, 0.05%, 1206	Panasonic, ERJ-8GEY0R00V	Digi-Key, P0.0ECT-ND
1	RF1	10G Ω , 0.25W, 10%, 1206	Ohmite, HVC1206Z1008KET	Digi-Key, HVC1206Z1008KETCT-ND
1	J1	BNC connector, right angle	Trompeter/Cinch Connectivity, UCBBJR29	Mouser, 530-UCBBJR29
1	J2	BNC connector, through hole	TE Connectivity, 1-1337445-0	Digi-Key, A101972-ND
1	JP3	3-pin header, 100 mil spacing	Samtec, TSW-103-08-G-S	Digi-Key, SAM1038-03-ND
3	J3, J4, J5	Banana jack, panel mount	Emerson Network Power Connectivity Johnson, 108-0740-001	Digi-Key, J147-ND
1	J6	Terminal block, 2-position	Keystone, 8718	Mouser, 534-8718
1	J7	Terminal block, 3-position	Keystone, 8719	Mouser, 534-8719
3	P4, P7, VOUT	Pin receptacle, 22 mil to 32 mil pin diameter	Mill-Max, 0294-0-15-15-06-27-10-0	Digi-Key, ED90072-ND
1	SHIELD1, SHEILD3	1.0 x 1.5 x 0.25 RF shield	Fotofab, DMP-1.0 X 1.5 X 0.25	Digi-Key, 655-1015-ND
1	SHIELD2	1.5 x 3.0 x 0.75 RF shield	Fotofab, 1.5 X 3.0 X 0.75	
3	N/A ¹	RF shield clip (to be used with SHIELD2)	Harwin, Inc., S1711-46R	Digi-Key, 952-1475-1-ND

¹ N/A means not applicable.

Table 11. Bill of Materials for ADA4530-1R-EBZ-BUF

Qty	Reference Designator	Description	Manufacturer Part Number	Distributor
1	U1	Femtoampere Input bias current electrometer amplifier (device under test)	Analog Devices, Inc., ADA4530-1	
2	C1, C2	0.1 μ F, 50 V, 5%, 0805	Kemet, C0805C104J5RACTU	Digi-Key, 399-1171-6-ND
2	C3, C4	10 μ F, 35 V, 10%, 7343	AVX, TPSD106K035R0125	Digi-Key, 478-3337-2-ND
1	RO	499 Ω , 0.125 W, 1%, 0805	Panasonic, ERJ-6ENF4990V	Digi-Key, P499CCT-ND
3	RF1, JP1	0 Ω , 0.25 W, 0.05%, 1206	Panasonic, ERJ-8GEY0R00V	Digi-Key, P0.0ECT-ND
1	J1	Triax connector, right angle, 3-lug	Emerson Network Power Connectivity Trompeter, CBBJR79/A	Digi-Key, 1097-1046-ND
1	J2	BNC connector, through hole	TE Connectivity, 1-1337445-0	Digi-Key, A101972-ND
1	JP3	3-pin header, 100 mil spacing	Samtec TSW-103-08-G-S	Digi-Key, SAM1038-03-ND
3	J3, J4, J5	Banana jack, panel mount	Emerson Network Power Connectivity Johnson, 108-0740-001	Digi-Key, J147-ND
1	J6	Terminal block, 2-position	Keystone, 8718	Mouser, 534-8718
1	J7	Terminal block, 3-position	Keystone, 8719	Mouser, 534-8719
3	P4, P7, VOUT	Pin receptacle, 22 mil to 32 mil pin diameter	Mill-Max, 0294-0-15-15-06-27-10-0	Digi-Key, ED90072-ND
1	SHIELD1, SHEILD3	1.0 x 1.5 x 0.25 RF shield	Fotofab, DMP-1.0 X 1.5 X 0.25	Digi-Key, 655-1015-ND
1	SHIELD2	1.5 x 3.0 x 0.75 RF Shield	Fotofab, 1.5 X 3.0 X 0.75	
3	N/A ¹	RF shield clip (to be used with SHIELD2)	Harwin, Inc., S1711-46R	Digi-Key, 952-1475-1-ND

¹ N/A means not applicable.

NOTES

**ESD Caution**

ESD (electrostatic discharge) sensitive device. Charged devices and circuit boards can discharge without detection. Although this product features patented or proprietary protection circuitry, damage may occur on devices subjected to high energy ESD. Therefore, proper ESD precautions should be taken to avoid performance degradation or loss of functionality.

Legal Terms and Conditions

By using the evaluation board discussed herein (together with any tools, components documentation or support materials, the "Evaluation Board"), you are agreeing to be bound by the terms and conditions set forth below ("Agreement") unless you have purchased the Evaluation Board, in which case the Analog Devices Standard Terms and Conditions of Sale shall govern. Do not use the Evaluation Board until you have read and agreed to the Agreement. Your use of the Evaluation Board shall signify your acceptance of the Agreement. This Agreement is made by and between you ("Customer") and Analog Devices, Inc. ("ADI"), with its principal place of business at One Technology Way, Norwood, MA 02062, USA. Subject to the terms and conditions of the Agreement, ADI hereby grants to Customer a free, limited, personal, temporary, non-exclusive, non-sublicensable, non-transferable license to use the Evaluation Board FOR EVALUATION PURPOSES ONLY. Customer understands and agrees that the Evaluation Board is provided for the sole and exclusive purpose referenced above, and agrees not to use the Evaluation Board for any other purpose. Furthermore, the license granted is expressly made subject to the following additional limitations: Customer shall not (i) rent, lease, display, sell, transfer, assign, sublicense, or distribute the Evaluation Board; and (ii) permit any Third Party to access the Evaluation Board. As used herein, the term "Third Party" includes any entity other than ADI, Customer, their employees, affiliates and in-house consultants. The Evaluation Board is NOT sold to Customer; all rights not expressly granted herein, including ownership of the Evaluation Board, are reserved by ADI. CONFIDENTIALITY. This Agreement and the Evaluation Board shall all be considered the confidential and proprietary information of ADI. Customer may not disclose or transfer any portion of the Evaluation Board to any other party for any reason. Upon discontinuation of use of the Evaluation Board or termination of this Agreement, Customer agrees to promptly return the Evaluation Board to ADI. ADDITIONAL RESTRICTIONS. Customer may not disassemble, decompile or reverse engineer chips on the Evaluation Board. Customer shall inform ADI of any occurred damages or any modifications or alterations it makes to the Evaluation Board, including but not limited to soldering or any other activity that affects the material content of the Evaluation Board. Modifications to the Evaluation Board must comply with applicable law, including but not limited to the RoHS Directive. TERMINATION. ADI may terminate this Agreement at any time upon giving written notice to Customer. Customer agrees to return to ADI the Evaluation Board at that time. LIMITATION OF LIABILITY. THE EVALUATION BOARD PROVIDED HEREUNDER IS PROVIDED "AS IS" AND ADI MAKES NO WARRANTIES OR REPRESENTATIONS OF ANY KIND WITH RESPECT TO IT. ADI SPECIFICALLY DISCLAIMS ANY REPRESENTATIONS, ENDORSEMENTS, GUARANTEES, OR WARRANTIES, EXPRESS OR IMPLIED, RELATED TO THE EVALUATION BOARD INCLUDING, BUT NOT LIMITED TO, THE IMPLIED WARRANTY OF MERCHANTABILITY, TITLE, FITNESS FOR A PARTICULAR PURPOSE OR NON-INFRINGEMENT OF INTELLECTUAL PROPERTY RIGHTS. IN NO EVENT WILL ADI AND ITS LICENSORS BE LIABLE FOR ANY INCIDENTAL, SPECIAL, INDIRECT, OR CONSEQUENTIAL DAMAGES RESULTING FROM CUSTOMER'S POSSESSION OR USE OF THE EVALUATION BOARD, INCLUDING BUT NOT LIMITED TO LOST PROFITS, DELAY COSTS, LABOR COSTS OR LOSS OF GOODWILL. ADI'S TOTAL LIABILITY FROM ANY AND ALL CAUSES SHALL BE LIMITED TO THE AMOUNT OF ONE HUNDRED US DOLLARS (\$100.00). EXPORT. Customer agrees that it will not directly or indirectly export the Evaluation Board to another country, and that it will comply with all applicable United States federal laws and regulations relating to exports. GOVERNING LAW. This Agreement shall be governed by and construed in accordance with the substantive laws of the Commonwealth of Massachusetts (excluding conflict of law rules). Any legal action regarding this Agreement will be heard in the state or federal courts having jurisdiction in Suffolk County, Massachusetts, and Customer hereby submits to the personal jurisdiction and venue of such courts. The United Nations Convention on Contracts for the International Sale of Goods shall not apply to this Agreement and is expressly disclaimed.