



5V – 48V Small Footprint, Surface Mount Transient Voltage Suppressors

DESCRIPTION

Microsemi's unique Powermite UPT series of transient voltage suppressors feature oxide-passivated chips with high-temperature solder bonds for high surge capability and negligible electrical degradation under repeated surge conditions. Both unidirectional and bidirectional configurations are available. In addition to its size advantages, the Powermite package includes a fully metallic bottom (cathode) side that eliminates the possibility of solder flux entrapment at assembly and a unique locking tab serves as an integral heat sink. Its innovative design makes this device fully compatible for use with automatic insertion equipment.

Important: For the latest information, visit our website <http://www.microsemi.com>.

FEATURES

- Powermite package with standoff voltages 5 to 48 V.
- Both unidirectional and bidirectional polarities:
 - Anode to case bottom (UPT5e3 thru UPT48e3)
 - Cathode to case bottom (UPT5Re3 thru UPT48Re3)
 - Bidirectional (UPTB5e3 thru UPTB48e3)
- Clamping time less than 100 pico-seconds for unidirectional and 5 nano-seconds for bidirectional.
- 100% surge current testing of all parts.
- Moisture classification is Level 1 with no dry pack required per IPC/JEDEC J-STD-020B.
- RoHS compliant versions available.

APPLICATIONS / BENEFITS

- Protects sensitive components such as IC's, CMOS, Bipolar, BiCMOS, ECL, DTL, T²L, etc.
- Protection from switching and induced RF transients.
- New improved lower leakage current for the UPT5Re3:
 - Integral heat sink / locking tabs
 - Fully metallic bottom side eliminates flux entrapment
- Compliant to IEC61000-4-2 and IEC61000-4-4 for ESD and EFT protection respectively.
- Secondary lightning protection per IEC61000-4-5 with 42 Ohms source impedance:
 - Class 1: UPT5/UPT5R/UPTB8 to17
 - Class 2: UPT5/UPT5R/UPTB5 to12

MAXIMUM RATINGS

Parameters/Test Conditions	Symbol	Value		Unit	
Junction and Storage Temperature	T _J / T _{STG}	-65 to +150		°C	
Thermal Resistance Junction-to-Ambient ⁽¹⁾	R _{θJA}	240		°C/W	
Thermal Resistance Junction-to-Case (base tab)	R _{θJC}	15		°C/W	
Peak Pulse Power (see Figure 1 and Figure 2)	P _{PP}	@ 8/20 μs	@ 10/1000μs	W	
		UPT5Re3:	600		100
		UPT5e3 thru UPT48e3:	1000		150
		UPT8Re3 thru UPT48Re3:	1000		150
		UPTB5e3 thru UPTB48e3:	1000		150
Rated Average Power Dissipation (base tab ≤ 112 °C)	P _{M(AV)}	2.5		W	
Impulse Repetition Rate (duty factor)		0.01		%	
Solder Temperature @ 10 s	T _{SP}	260		°C	

Notes: 1. When mounted on FR4 PC board with 1 oz copper.

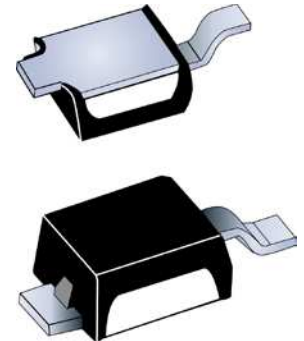

**Powermite 1
(DO-216AA)
Package**

MSC – Lawrence

6 Lake Street,
Lawrence, MA 01841
Tel: 1-800-446-1158 or
(978) 620-2600
Fax: (978) 689-0803

MSC – Ireland

Gort Road Business Park,
Ennis, Co. Clare, Ireland
Tel: +353 (0) 65 6840044
Fax: +353 (0) 65 6822298

Website:

www.microsemi.com

MECHANICAL and PACKAGING

- CASE: Void-free transfer molded thermosetting epoxy compound meeting UL94V-0.
- TERMINALS: Annealed matte-tin plating over copper and readily solderable per MIL-STD-750, method 2026.
- MARKING:
 - Anode to TAB 1:** T plus the last two digits of part number underlined, e.g. UPT5e3 is T05, UPT12e3 is T12.
 - Cathode to TAB1:** U plus last two digits of part number underlined, e.g. UPT5Re3 is U05, UPT12Re3 is U12.
 - Bipolar:** B plus the last two digits of part number underlined, e.g. UPTB8e3 is B08, UPTB12e3 is B12, etc.

Please note dot suffix (for e3 suffix)
- POLARITY: Cathode or anode to TAB 1 (bottom) as described in marking above and on [last page](#).
- TAPE & REEL option: Standard per EIA-481-B using 12 mm tape. Consult factory for quantities.
- WEIGHT: Approximately 0.016 gram.
- See [package dimensions](#) on last page.

PART NOMENCLATURE

Applicable to unidirectional UPT5e3 – UPT48e3, UPT5Re3 – UPT48Re3 only:

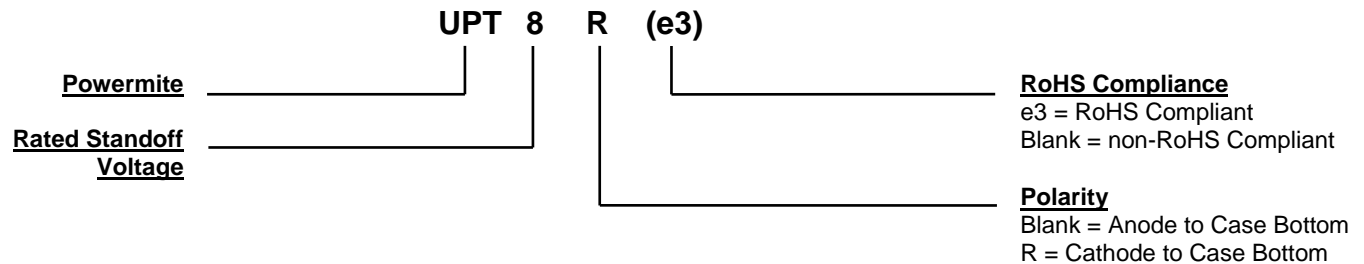

Applicable to bidirectional UPTB5e3 – UPTB48e3 only:

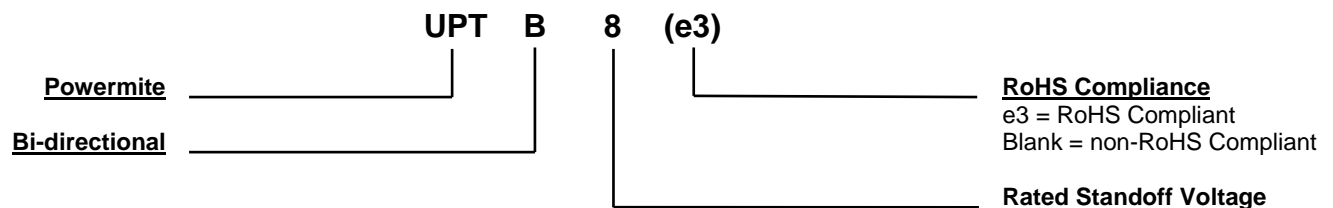
SYMBOLS & DEFINITIONS

Symbol	Definition
$V_{(BR)}$	Breakdown Voltage: The minimum voltage the device will exhibit at a specified current.
V_{WM}	Working Peak Standoff Voltage: The maximum peak voltage that can be applied over the operating temperature range.
P_{PP}	Peak Pulse Power: The peak power that can be applied for a specified pulse width and waveform.
I_D	Standby Current: The maximum current that will flow at the specified voltage and temperature.
I_{PP}	Peak Pulse Current: The peak current that can be applied for a specified pulse width and waveform.
C	Capacitance: The capacitance in picofarads of the TVS as defined @ 0 volts at a frequency of 1 MHz.

ELECTRICAL CHARACTERISTICS

DEVICE TYPE		RATED STANDOFF VOLTAGE	MINIMUM BREAKDOWN VOLTAGE	MAXIMUM STANDBY CURRENT	MAXIMUM PEAK PULSE CURRENT*	MAXIMUM CLAMPING VOLTAGE	MAXIMUM TEMPERATURE COEFFICIENT of $V_{(BR)}$
		V_{WM}	$V_{(BR)}$ @ 1 mA	I_D @ V_{WM}	I_{PP} @ 10/1000 μs	V_C @ I_{PP}	$\alpha_{V(BR)}$
Unidirectional	Bi-directional	V	V	μA	A	V	%/°C
UPT5	UPTB5	5	6.0	50	15.7	9.5	0.030
UPT5R		5	6.0	5	10.5	9.5	0.030
UPT8 & UPT8R	UPTB8	8	9.0	2	10.9	13.7	0.040
UPT10 & UPT10R	UPTB10	10	11.0	2	8.33	18.0	0.045
UPT12 & UPT12R	UPTB12	12	13.8	1	6.94	21.6	0.050
UPT15 & UPT15R	UPTB15	15	16.7	1	5.77	26.0	0.055
UPT17 & UPT17R	UPTB17	17	19.0	1	5.14	29.2	0.060
UPT24 & UPT24R	UPTB24	24	28.4	1	3.47	43.2	0.070
UPT28 & UPT28R	UPTB28	28	31.0	1	3.13	47.8	0.075
UPT33 & UPT33R	UPTB33	33	36.8	1	2.65	56.7	0.080
UPT48 & UPT48R	UPTB48	48	54.0	1	1.78	84.3	0.090

* See [figure 1](#) for I_{PP} waveform of 10/1000 μs test pulse.

GRAPHS

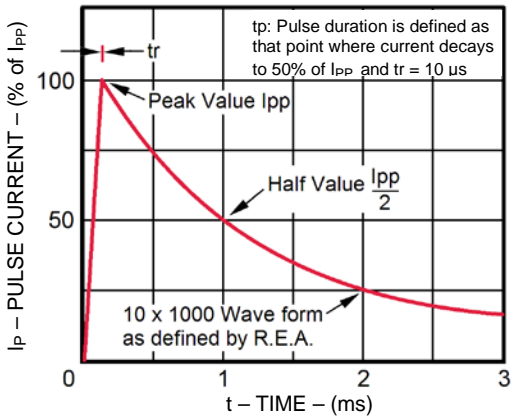

FIGURE 1
Pulse Waveform for 10/1000 μ s Exponential Surge

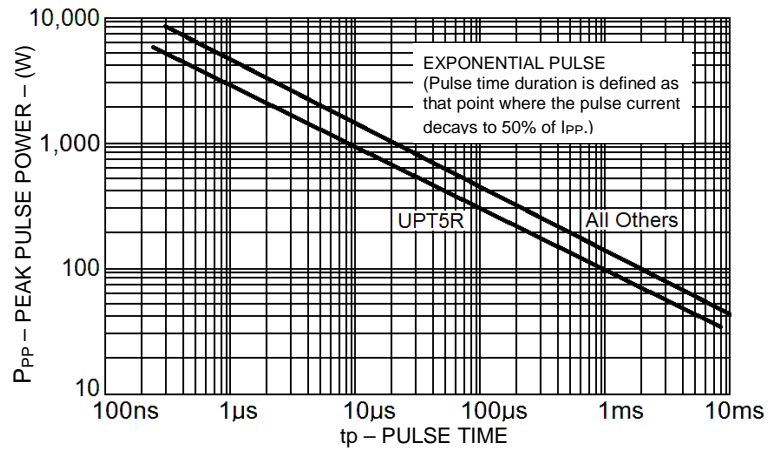

FIGURE 2
Peak Pulse Power vs. Pulse Duration

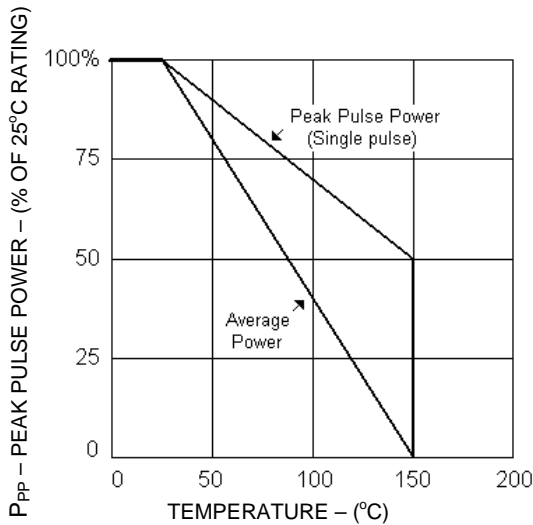

FIGURE 3
Derating Curve

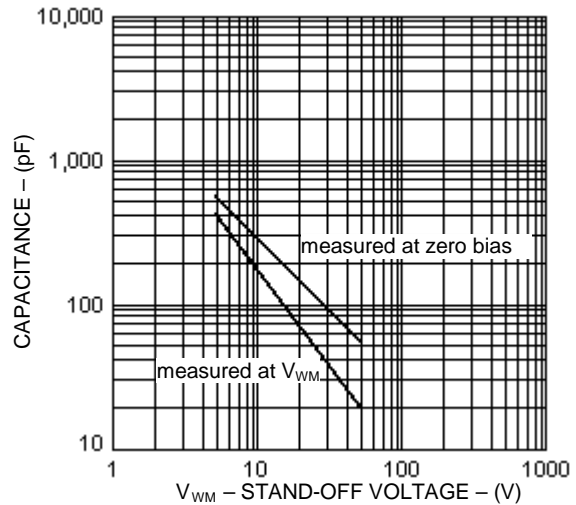
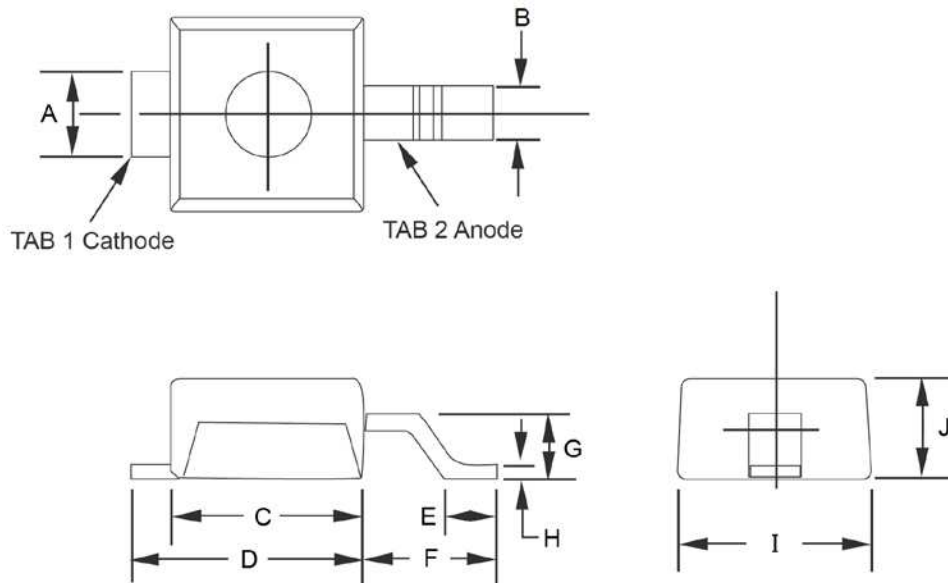
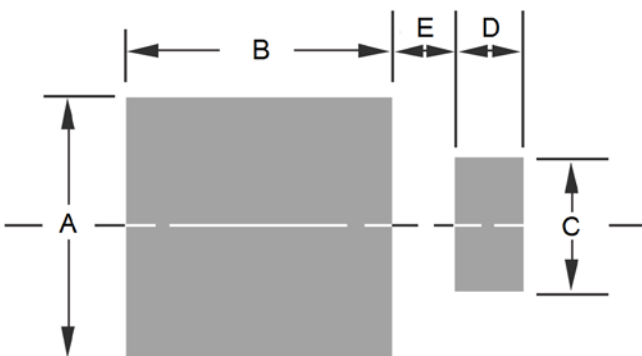

FIGURE 4
Typical Capacitance vs. Stand-Off Voltage

PACKAGE DIMENSIONS

Ltr	Dimensions			
	Inch		Millimeters	
	Min	Max	Min	Max
A	0.029	0.039	0.73	0.99
B	0.016	0.026	0.40	0.66
C	0.070	0.080	1.77	2.03
D	0.087	0.097	2.21	2.46
E	0.020	0.030	0.50	0.76
F	0.051	0.061	1.29	1.54
G	0.021	0.031	0.53	0.78
H	0.004	0.008	0.10	0.20
I	0.070	0.080	1.77	2.03
J	0.035	0.045	0.89	1.14

PAD LAYOUT

Ltr	Dimensions	
	Inch	Millimeters
A	0.100	2.54
B	0.105	2.67
C	0.050	1.27
D	0.030	0.76
E	0.025	0.64