

# MAX9015–MAX9020

# SOT23, Dual, Precision, 1.8V, Nanopower Comparators With/Without Reference

## General Description

The single MAX9015/MAX9016 and dual MAX9017–MAX9020 nanopower comparators in space-saving SOT23 packages feature Beyond-the-Rails™ inputs and are guaranteed to operate down to 1.8V. The A-grade packages feature an on-board 1.236V ±1% reference, while the B-grade packages feature a 1.24V ±1.75% reference. An ultra-low supply current of 0.85µA (MAX9019/MAX9020), 1µA (MAX9015/MAX9016), or 1.2µA (MAX9017/MAX9018) makes the MAX9015–MAX9020 family of comparators ideal for all 2-cell battery monitoring/management applications.

The unique design of the MAX9015–MAX9020 output stage limits supply-current surges while switching, which virtually eliminates the supply glitches typical of many other comparators. This design also minimizes overall power consumption under dynamic conditions. The MAX9015/MAX9017/MAX9019 have a push-pull output stage that sinks and sources current. Large internal output drivers allow rail-to-rail output swing with loads up to 6mA. The MAX9016/MAX9018/MAX9020 have an open-drain output stage that makes them suitable for mixed-voltage system design. All devices are available in the ultra-small 8-pin SOT23 package.

Refer to the MAX9117–MAX9120 data sheet for similar single comparators with or without reference in a tiny SC70 package.

## Applications

2-Cell Battery Monitoring/Management	Window Detectors
Ultra-Low Power Systems	Sensing at Ground or Supply Line
Mobile Communications	Telemetry and Remote Systems
Notebooks and PDAs	Medical Instruments
Threshold Detectors/Discriminators	

## Selector Guide

PART	COMPARATOR(S)	INTERNAL REFERENCE (V)	OUTPUT TYPE	SUPPLY CURRENT (µA)
MAX9015A	1	1.236 ±1%	Push-pull	1
MAX9016A	1	1.236 ±1%	Open drain	1
MAX9017A	2	1.236 ±1%	Push-pull	1.2
MAX9017B	2	1.240 ±1.75%	Push-pull	1.2
MAX9018A	2	1.236 ±1%	Open drain	1.2
MAX9018B	2	1.240 ±1.75%	Open drain	1.2
MAX9019	2	—	Push-pull	0.85
MAX9020	2	—	Open drain	0.85

## Features

- Ultra-Low Total Supply Current
  - 0.85µA (MAX9019/MAX9020)
  - 1.0µA (MAX9015A/MAX9016A)
  - 1.2µA (MAX9017/MAX9018)
- Guaranteed Operation Down to 1.8V
- Precision  $V_{OS} < 5\text{mV}$  (max)
- Internal 1.236V ±1% Reference (A Grade)
- Input Voltage Range Extends 200mV Beyond-the-Rails
- CMOS Push-Pull Output with ±6mA Drive Capability (MAX9015/MAX9017/MAX9019)
- Open-Drain Output Versions Available (MAX9016/MAX9018/MAX9020)
- Crowbar-Current-Free Switching
- Internal 4mV Hysteresis for Clean Switching
- No Phase Reversal for Overdriven Inputs
- Dual Versions in Space-Saving 8-Pin SOT23 Package

## Ordering Information

PART	TEMP RANGE	PIN-PACKAGE	TOP MARK
MAX9015AEKA-T	-40°C to +85°C	8 SOT23	AEIW
MAX9015AEKA/V+T	-40°C to +85°C	8 SOT23	+AETV
MAX9016AEKA-T	-40°C to +85°C	8 SOT23	AEIX
MAX9017AEKA-T	-40°C to +85°C	8 SOT23	AEIQ
MAX9017BEKA-T	-40°C to +85°C	8 SOT23	AEIS

T = Tape and reel.

/V denotes an automotive qualified part.

Ordering Information continued at end of data sheet.

Pin Configurations appear at end of data sheet.

Beyond-the-Rails is a trademark of Maxim Integrated Products, Inc.

# MAX9015–MAX9020

# SOT23, Dual, Precision, 1.8V, Nanopower Comparators With/Without Reference

## Absolute Maximum Ratings

Supply Voltage ( $V_{CC}$  to  $V_{EE}$ ) .....6V  
 $IN+$ ,  $IN-$ ,  $INA+$ ,  $INB+$ ,  $INA-$ ,  $INB-$ ,  
 $REF/INA-$ ,  $REF$  .....( $V_{EE} - 0.3V$ ) to ( $V_{CC} + 0.3V$ )  
 Output Voltage ( $OUT_+$ )  
 MAX9015A, MAX9017\_, MAX9019\_ .....( $V_{EE} - 0.3V$ ) to ( $V_{CC} + 0.3V$ )  
 MAX9016A, MAX9018\_, MAX9020\_ .....( $V_{EE} - 0.3V$ ) to +6V  
 Output Current ( $REF$ ,  $OUT_+$ ,  $REF/INA-$ ) ..... $\pm 50mA$

Output Short-Circuit Duration ( $REF$ ,  $OUT_+$ ,  $REF/INA-$ ) .....10s  
 Continuous Power Dissipation ( $T_A = +70^\circ C$ )  
 8-Pin SOT23 (derate 9.1mW/ $^\circ C$  above  $+70^\circ C$ ) .....727mW  
 Operating Temperature Range ..... $-40^\circ C$  to  $+85^\circ C$   
 Storage Temperature Range ..... $-65^\circ C$  to  $+150^\circ C$   
 Junction Temperature ..... $+150^\circ C$   
 Lead Temperature (soldering, 10s) ..... $+300^\circ C$   
 Soldering Temperature (reflow) ..... $+260^\circ C$

Stresses beyond those listed under "Absolute Maximum Ratings" may cause permanent damage to the device. These are stress ratings only, and functional operation of the device at these or any other conditions beyond those indicated in the operational sections of the specifications is not implied. Exposure to absolute maximum rating conditions for extended periods may affect device reliability.

## Electrical Characteristics—MAX9015–MAX9018 (Single and Duals with REF)

( $V_{CC} = 5V$ ,  $V_{EE} = 0V$ ,  $V_{IN-} = V_{REF}$ ,  $T_A = -40^\circ C$  to  $+85^\circ C$ , unless otherwise noted. Typical values are at  $T_A = +25^\circ C$ .) (Note 1)

PARAMETER	SYMBOL	CONDITIONS	MIN	TYP	MAX	UNITS	
Supply Voltage Range	$V_{CC}$	Inferred from the PSRR test	1.8		5.5	V	
Supply Current	$I_{CC}$	MAX9015A/ MAX9016A	$V_{CC} = 1.8V$ , $T_A = +25^\circ C$	1.0	1.5	$\mu A$	
			$V_{CC} = 5.0V$ , $T_A = +25^\circ C$	1.1	1.7		
		MAX9017_/ MAX9018_	$V_{CC} = 5.0V$ , $T_A = T_{MIN}$ to $T_{MAX}$		2.0		
			$V_{CC} = 1.8V$ , $T_A = +25^\circ C$	1.2	1.9		
			$V_{CC} = 5.0V$ , $T_A = +25^\circ C$	1.4	2.3		
			$V_{CC} = 5.0V$ , $T_A = T_{MIN}$ to $T_{MAX}$		2.8		
Input Common-Mode Voltage Range (MAX9015A/MAX9016A)	$V_{CM}$	Inferred from $V_{OS}$ test	$V_{EE} - 0.2$		$V_{CC} + 0.2$	V	
$IN+$ Voltage Range (MAX9017_/MAX9018_)	$V_{IN+}$	Inferred from the output swing test	$V_{EE} - 0.2$		$V_{CC} + 0.2$	V	
Input Offset Voltage	$V_{OS}$	$V_{EE} - 0.2V < V_{CM} < V_{CC} + 0.2V$ (Note 2)	$T_A = +25^\circ C$	0.15	5	mV	
			$T_A = T_{MIN}$ to $T_{MAX}$		10		
Input-Referred Hysteresis	$V_{HB}$	$V_{EE} - 0.2V < V_{CM} < V_{CC} + 0.2V$ (Note 3)		4		mV	
Input Bias Current ( $IN+$ , $IN-$ , $INA+$ , $INB+$ , $INB-$ )	$I_B$	$T_A = +25^\circ C$		$\pm 0.15$	$\pm 1$	nA	
		$T_A = T_{MIN}$ to $T_{MAX}$			$\pm 2$		
Power-Supply Rejection Ratio	PSRR	$V_{CC} = 1.8V$ to $5.5V$		0.1	1	mV/V	
Output Voltage Swing High (MAX9015A/MAX9017_)	$V_{CC} - V_{OH}$	$V_{CC} = 1.8V$ , $I_{SOURCE} = 1mA$	$T_A = +25^\circ C$	100	200	mV	
			$T_A = T_{MIN}$ to $T_{MAX}$		300		
		$V_{CC} = 5.0V$ , $I_{SOURCE} = 6mA$	$T_A = +25^\circ C$	250	350		
			$T_A = T_{MIN}$ to $T_{MAX}$		450		
Output Voltage Swing Low (MAX9015A/MAX9016A/ MAX9017_/MAX9018_)	$V_{OL}$	$V_{CC} = 1.8V$ , $I_{SINK} = 1mA$	$T_A = +25^\circ C$	105	200	mV	
			$T_A = T_{MIN}$ to $T_{MAX}$		300		
		$V_{CC} = 5.0V$ , $I_{SINK} = 6mA$	$T_A = +25^\circ C$	285	350		
			$T_A = T_{MIN}$ to $T_{MAX}$		450		

**Electrical Characteristics—MAX9015–MAX9018 (Single and Duals with REF)  
(continued)**(V<sub>CC</sub> = 5V, V<sub>EE</sub> = 0V, V<sub>IN-</sub> = V<sub>REF</sub>, T<sub>A</sub> = -40°C to +85°C, unless otherwise noted. Typical values are at T<sub>A</sub> = +25°C.) (Note 1)

PARAMETER	SYMBOL	CONDITIONS		MIN	TYP	MAX	UNITS
Output Leakage Current (MAX9016A/MAX9018_)	I <sub>LEAK</sub>	V <sub>CC</sub> = 5.5V, V <sub>OUT</sub> = 5.5V			0.001	1	μA
Output Short-Circuit Current	I <sub>SC</sub>	Sourcing, V <sub>OUT</sub> = V <sub>EE</sub> (MAX9015A/ MAX9017_ only)	V <sub>CC</sub> = 1.8V		3		mA
			V <sub>CC</sub> = 5.0V		35		
		Sinking, V <sub>OUT</sub> = V <sub>CC</sub>	V <sub>CC</sub> = 1.8V		3		
			V <sub>CC</sub> = 5.0V		33		
High-to-Low Propagation Delay (Note 4)	t <sub>PD-</sub>	V <sub>CC</sub> = 1.8V			7		μs
		V <sub>CC</sub> = 5.0V			6		
Low-to-High Propagation Delay (Note 4)	t <sub>PD+</sub>	V <sub>CC</sub> = 1.8V	MAX9015A/MAX9017_		11		μs
			MAX9016A/MAX9018_, R <sub>PULLUP</sub> = 100kΩ to V <sub>CC</sub>		12		
		V <sub>CC</sub> = 5.0V	MAX9015A/MAX9017_		28		
			MAX9016A/MAX9018_, R <sub>PULLUP</sub> = 100kΩ to V <sub>CC</sub>		31		
Rise Time	t <sub>RISE</sub>	C <sub>L</sub> = 15pF (MAX9015A/MAX9017_)			1.6		μs
Fall Time	t <sub>FALL</sub>	C <sub>L</sub> = 15pF			0.2		μs
Power-Up Time	t <sub>ON</sub>				1.2		ms
Reference Voltage (Note 5)	V <sub>REF</sub>	MAX901_A	T <sub>A</sub> = +25°C, 1.0%	1.224	1.236	1.248	V
			T <sub>A</sub> = T <sub>MIN</sub> to T <sub>MAX</sub> , 2.5%	1.205		1.267	
		MAX901_B	T <sub>A</sub> = +25°C, 1.75%	1.218	1.240	1.262	
			T <sub>A</sub> = T <sub>MIN</sub> to T <sub>MAX</sub> , 4.5%	1.184		1.296	
Reference Voltage Temperature Coefficient	T <sub>CREF</sub>				40		ppm/°C
Reference Output Voltage Noise	E <sub>N</sub>	BW = 10Hz to 1kHz, C <sub>REF</sub> = 1nF			29		μV <sub>RMS</sub>
		BW = 10Hz to 6kHz, C <sub>REF</sub> = 1nF			60		
Reference Line Regulation	$\frac{\Delta V_{REF}}{\Delta V_{CC}}$	1.8V ≤ V <sub>CC</sub> ≤ 5.5V			0.5		mV/V
Reference Load Regulation	$\frac{\Delta V_{REF}}{\Delta I_{OUT}}$	I <sub>OUT</sub> = 0 to 100nA			0.03		mV/nA

**Electrical Characteristics—MAX9019/MAX9020 (Duals without REF)**(V<sub>CC</sub> = 5V, V<sub>EE</sub> = 0V, T<sub>A</sub> = -40°C to +85°C, unless otherwise noted. Typical values are at T<sub>A</sub> = +25°C.) (Note 1)

PARAMETER	SYMBOL	CONDITIONS		MIN	TYP	MAX	UNITS
Supply Voltage Range	V <sub>CC</sub>	Inferred from the PSRR test		1.8		5.5	V
Supply Current	I <sub>CC</sub>	MAX9019/ MAX9020	V <sub>CC</sub> = 1.8V, T <sub>A</sub> = +25°C		0.85	1.50	μA
			V <sub>CC</sub> = 5.0V, T <sub>A</sub> = +25°C		1.1	1.70	
			V <sub>CC</sub> = 5.0V, T <sub>A</sub> = T <sub>MIN</sub> to T <sub>MAX</sub>			2.0	
Input Common-Mode Voltage Range	V <sub>CM</sub>	Inferred from V <sub>OS</sub> test		V <sub>EE</sub> - 0.2		V <sub>CC</sub> + 0.2	V
Input Offset Voltage	V <sub>OS</sub>	V <sub>EE</sub> - 0.2V < V <sub>CM</sub> < V <sub>CC</sub> + 0.2V (Note 2)	T <sub>A</sub> = +25°C		1	5	mV
			T <sub>A</sub> = T <sub>MIN</sub> to T <sub>MAX</sub>			10	
Input-Referred Hysteresis	V <sub>HB</sub>	V <sub>EE</sub> - 0.2V < V <sub>CM</sub> < V <sub>CC</sub> + 0.2V (Note 3)			4		mV
Input Bias Current (INA-, INA+, INB+, INB-)	I <sub>B</sub>	T <sub>A</sub> = +25°C			0.15	1	nA
		T <sub>A</sub> = T <sub>MIN</sub> to T <sub>MAX</sub>				2	
Power-Supply Rejection Ratio	PSRR	V <sub>CC</sub> = 1.8V to 5.5V			0.1	1	mV/V
Output Voltage Swing High (MAX9019 Only)	V <sub>CC</sub> - V <sub>OH</sub>	V <sub>CC</sub> = 1.8V, I <sub>SOURCE</sub> = 1mA	T <sub>A</sub> = +25°C		55	200	mV
			T <sub>A</sub> = T <sub>MIN</sub> to T <sub>MAX</sub>			300	
		V <sub>CC</sub> = 5.0V, I <sub>SOURCE</sub> = 6mA	T <sub>A</sub> = +25°C		190	350	
			T <sub>A</sub> = T <sub>MIN</sub> to T <sub>MAX</sub>			450	
Output Voltage Swing Low	V <sub>OL</sub>	V <sub>CC</sub> = 1.8V, I <sub>SINK</sub> = 1mA	T <sub>A</sub> = +25°C		55	200	mV
			T <sub>A</sub> = T <sub>MIN</sub> to T <sub>MAX</sub>			300	
		V <sub>CC</sub> = 5.0V, I <sub>SINK</sub> = 6mA	T <sub>A</sub> = +25°C		190	350	
			T <sub>A</sub> = T <sub>MIN</sub> to T <sub>MAX</sub>			450	
Output Leakage Current (MAX9020 Only)	I <sub>LEAK</sub>	V <sub>CC</sub> = 5.5V, V <sub>OUT</sub> = 5.5V			0.001	1	μA
Output Short-Circuit Current	I <sub>SC</sub>	Sourcing, V <sub>OUT</sub> = V <sub>EE</sub> (MAX9019 only)	V <sub>CC</sub> = 1.8V		3		mA
			V <sub>CC</sub> = 5.0V		35		
		Sinking, V <sub>OUT</sub> = V <sub>CC</sub>	V <sub>CC</sub> = 1.8V		3		
			V <sub>CC</sub> = 5.0V		33		
High-to-Low Propagation Delay (Note 4)	t <sub>PD-</sub>	V <sub>CC</sub> = 1.8V			7		μs
		V <sub>CC</sub> = 5.0V			6		
Low-to-High Propagation Delay (Note 4)	t <sub>PD+</sub>	V <sub>CC</sub> = 1.8V	MAX9019		11		μs
			MAX9020, R <sub>PULLUP</sub> = 100kΩ to V <sub>CC</sub>		12		
		V <sub>CC</sub> = 5.0V	MAX9019		28		
			MAX9020, R <sub>PULLUP</sub> = 100kΩ to V <sub>CC</sub>		31		

**Electrical Characteristics—MAX9019/MAX9020 (Duals without REF) (continued)**

( $V_{CC} = 5V$ ,  $V_{EE} = 0V$ ,  $T_A = -40^{\circ}C$  to  $+85^{\circ}C$ , unless otherwise noted. Typical values are at  $T_A = +25^{\circ}C$ .) (Note 1)

PARAMETER	SYMBOL	CONDITIONS	MIN	TYP	MAX	UNITS
Rise Time	$t_{RISE}$	$C_L = 15pF$ (MAX9019 only)		1.6		$\mu s$
Fall Time	$t_{FALL}$	$C_L = 15pF$		0.2		$\mu s$
Power-Up Time	$t_{ON}$			1.2		ms

**-Note 1:** All devices are 100% tested at  $T_A = +25^{\circ}C$ . Specifications over temperature ( $T_A = T_{MIN}$  to  $T_{MAX}$ ) are guaranteed by design, not production tested.

**Note 2:**  $V_{OS}$  is defined as the center of the hysteresis band at the input.

**Note 3:** The hysteresis-related trip points are defined as the edges of the hysteresis band, measured with respect to the center of the band (i.e.,  $V_{OS}$ ) (Figure 1).

**Note 4:** Specified with an input overdrive ( $V_{OVERDRIVE}$ ) of 100mV, and a load capacitance of  $C_L = 15pF$ .  $V_{OVERDRIVE}$  is defined above and beyond the offset voltage and hysteresis of the comparator input.

**Note 5:** High current traces should not be routed in the vicinity of or below MAX9018. There is a chance of voltage reference being overloaded resulting in drop of output voltage.

**Typical Operating Characteristics**

( $V_{CC} = 5V$ ,  $V_{EE} = 0V$ ,  $C_L = 15pF$ ,  $V_{OVERDRIVE} = 100mV$ ,  $T_A = +25^{\circ}C$ , unless otherwise noted.)

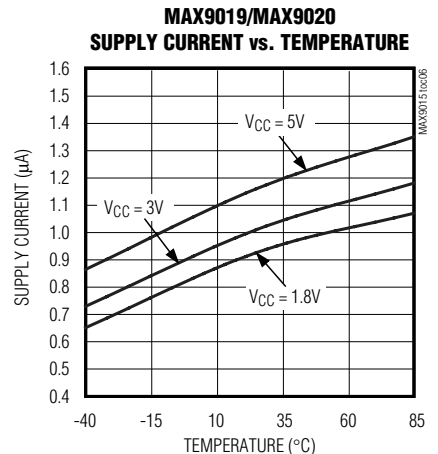
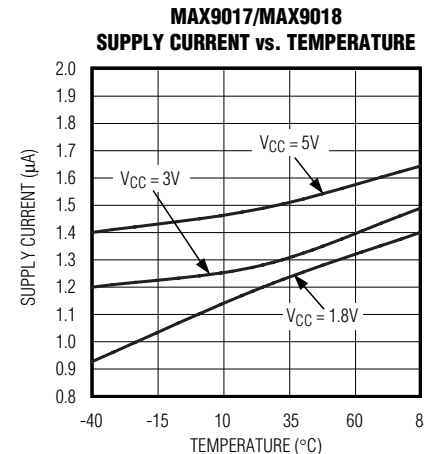
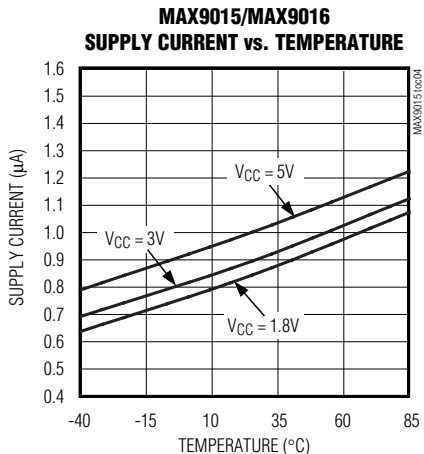
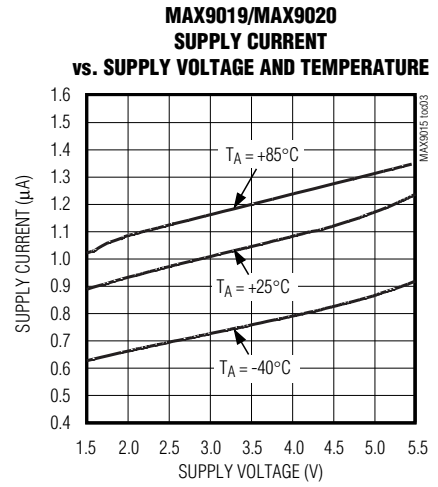
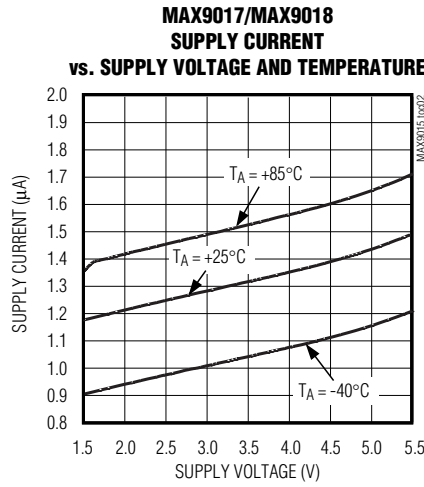
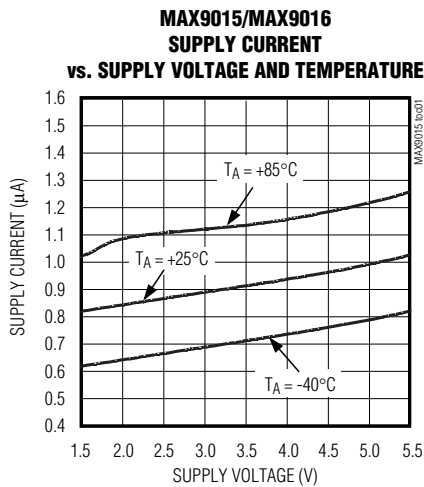

Typical Operating Characteristics (continued)

( $V_{CC} = 5V$ ,  $V_{EE} = 0V$ ,  $C_L = 15pF$ ,  $V_{OVERDRIVE} = 100mV$ ,  $T_A = +25^{\circ}C$ , unless otherwise noted.)

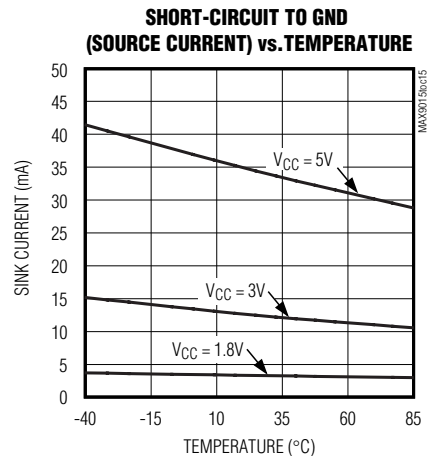
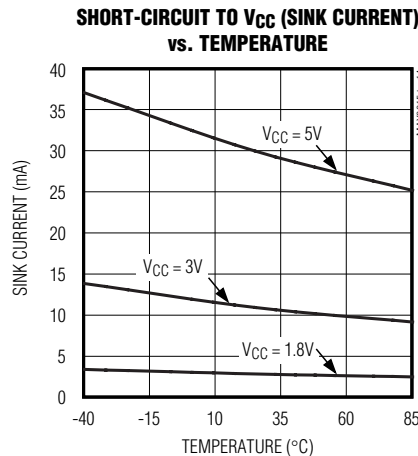
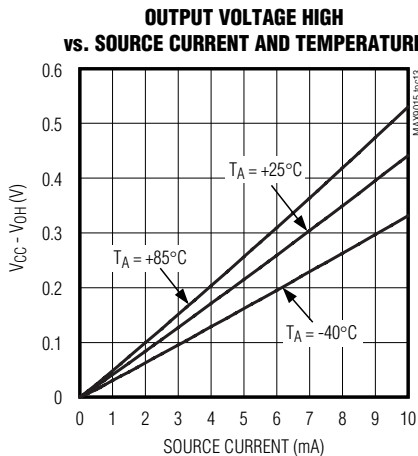
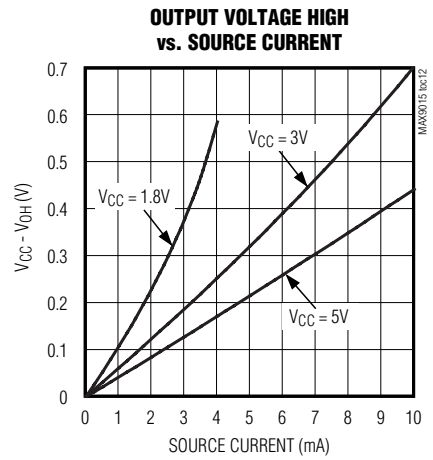
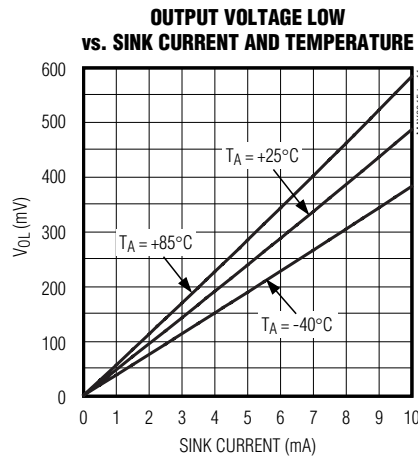
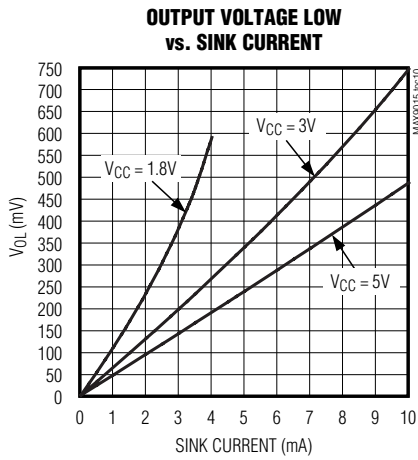
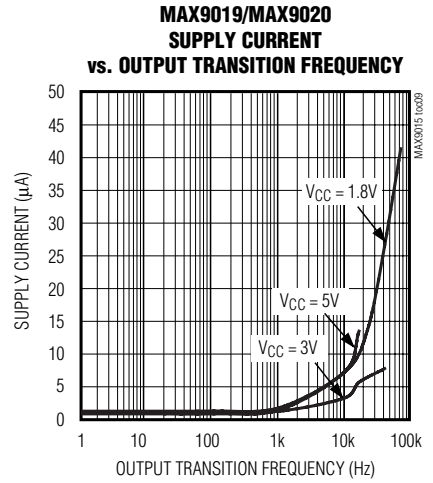
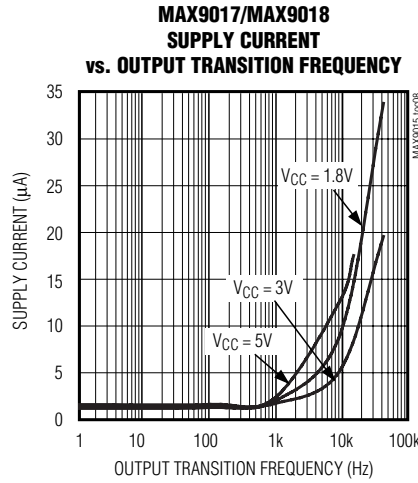
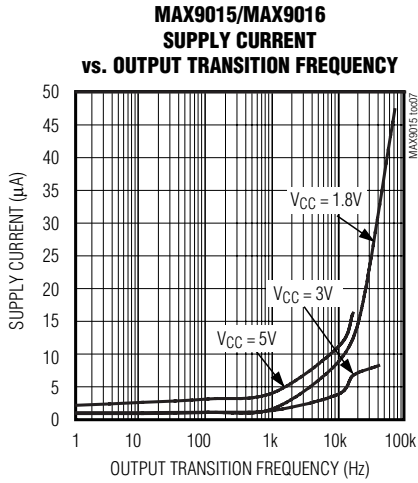

Typical Operating Characteristics (continued)

( $V_{CC} = 5V$ ,  $V_{EE} = 0V$ ,  $C_L = 15pF$ ,  $V_{OVERDRIVE} = 100mV$ ,  $T_A = +25^\circ C$ , unless otherwise noted.)

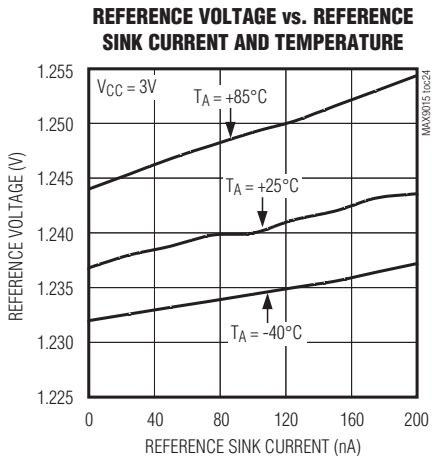
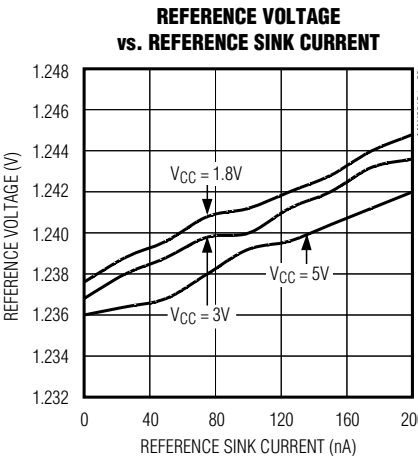
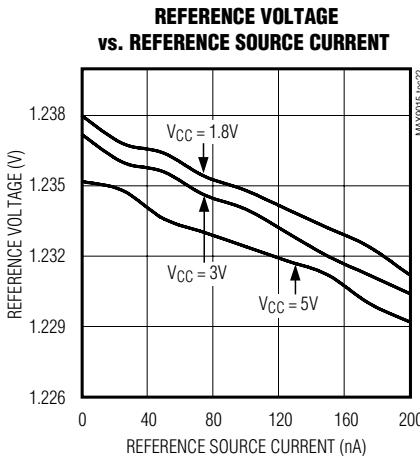
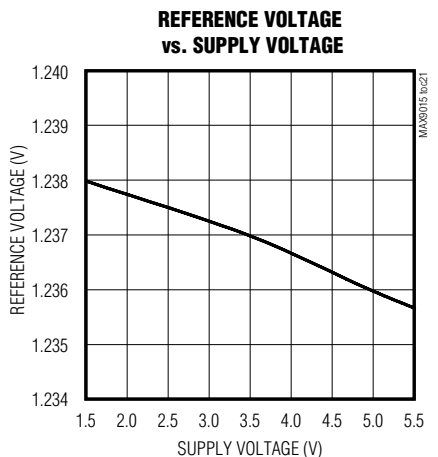
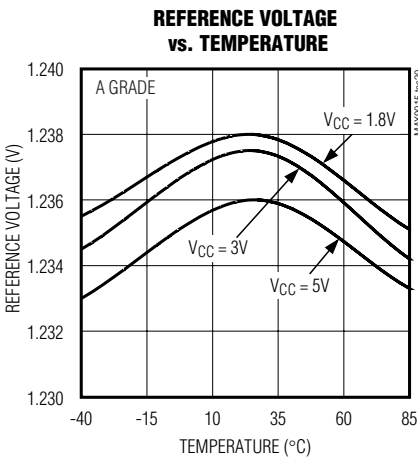
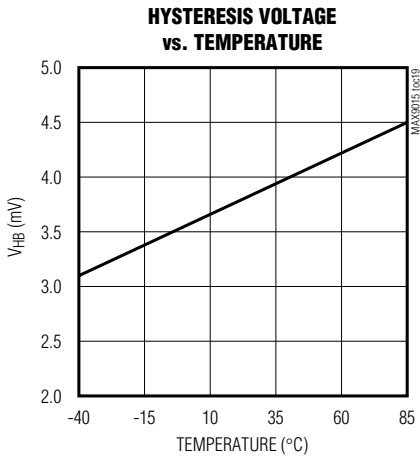
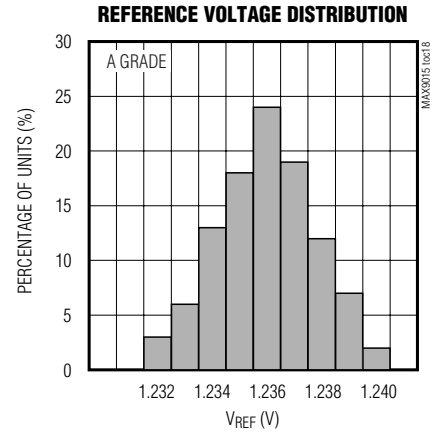
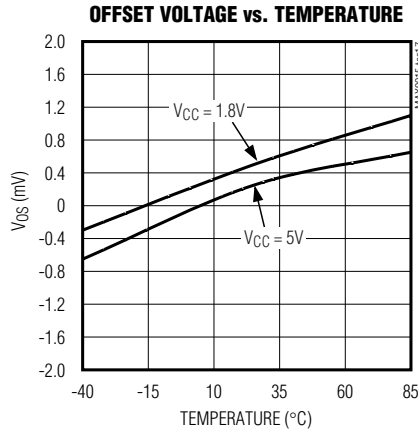
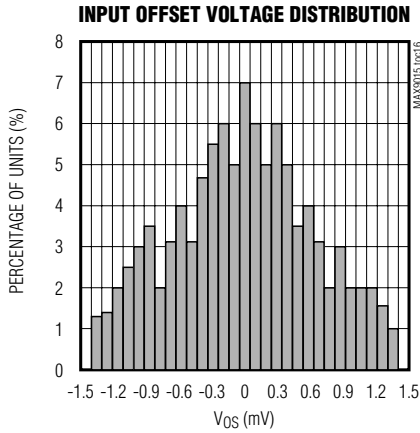

Typical Operating Characteristics (continued)

( $V_{CC} = 5V$ ,  $V_{EE} = 0V$ ,  $C_L = 15pF$ ,  $V_{OVERDRIVE} = 100mV$ ,  $T_A = +25^{\circ}C$ , unless otherwise noted.)

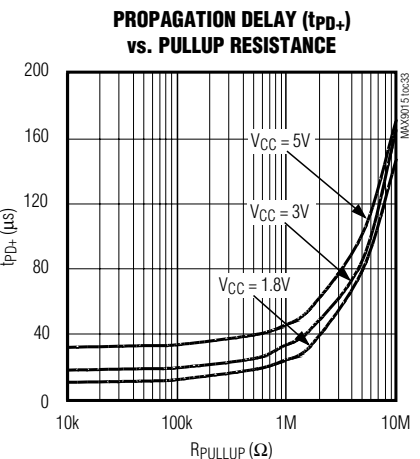
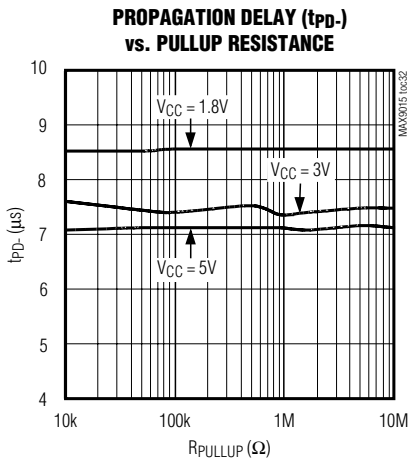
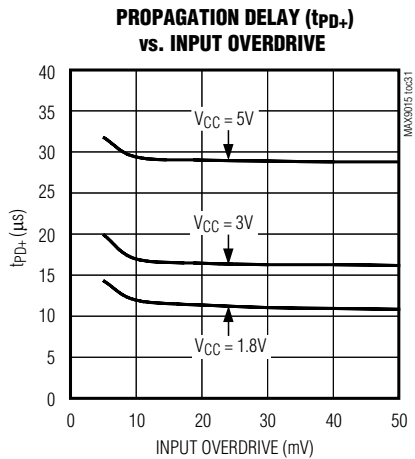
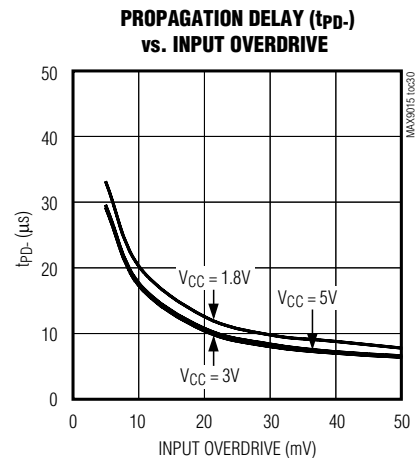
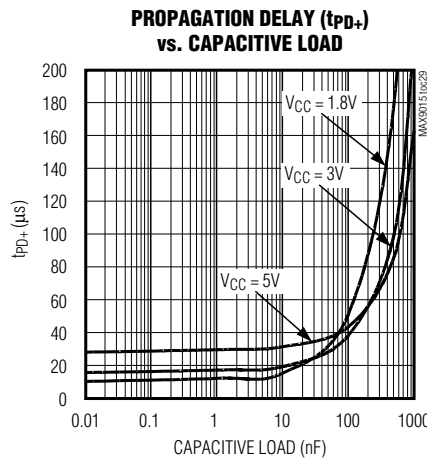
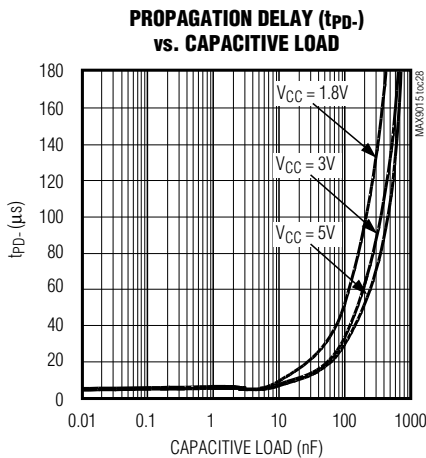
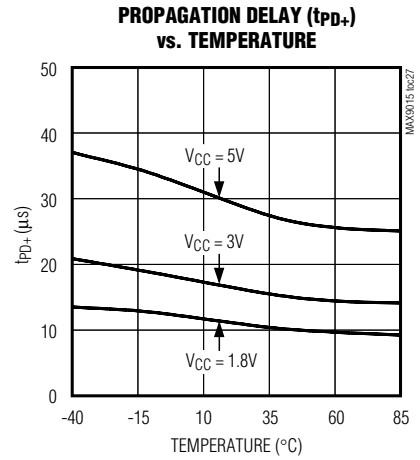
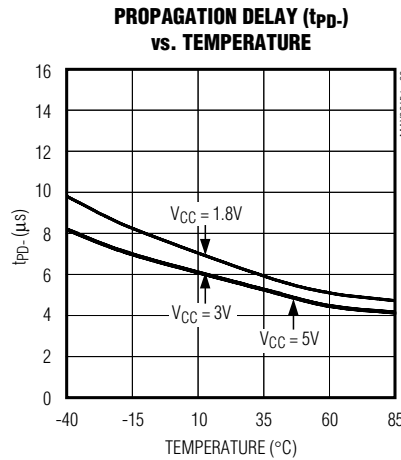
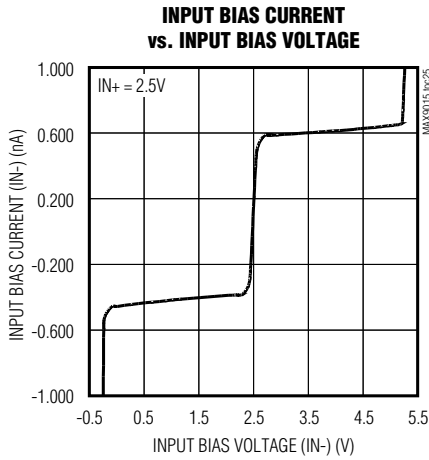



Typical Operating Characteristics (continued)

( $V_{CC} = 5V$ ,  $V_{EE} = 0V$ ,  $C_L = 15pF$ ,  $V_{OVERDRIVE} = 100mV$ ,  $T_A = +25^\circ C$ , unless otherwise noted.)

PROPAGATION DELAY ( $t_{PD-}$ ) ( $V_{CC} = 5V$ )

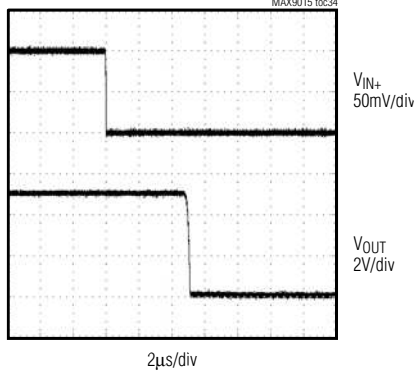

PROPAGATION DELAY ( $t_{PD+}$ ) ( $V_{CC} = 5V$ )

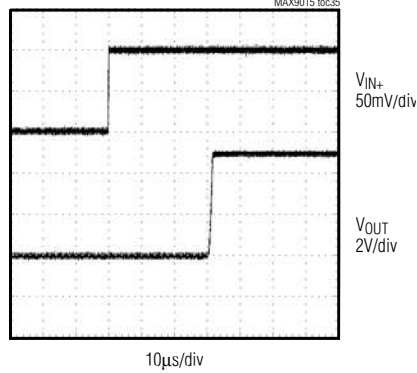

PROPAGATION DELAY ( $t_{PD-}$ ) ( $V_{CC} = 3V$ )

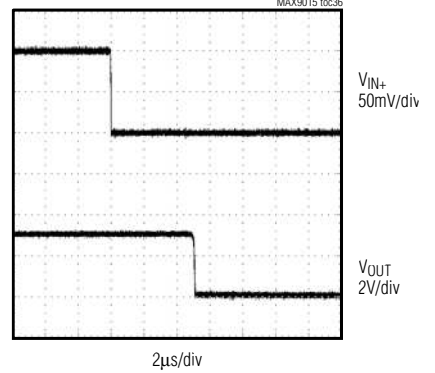

PROPAGATION DELAY ( $t_{PD+}$ ) ( $V_{CC} = 3V$ )

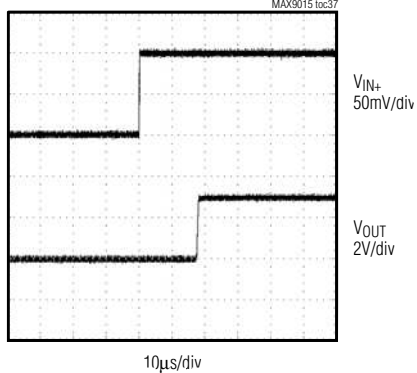

PROPAGATION DELAY ( $t_{PD-}$ ) ( $V_{CC} = 1.8V$ )

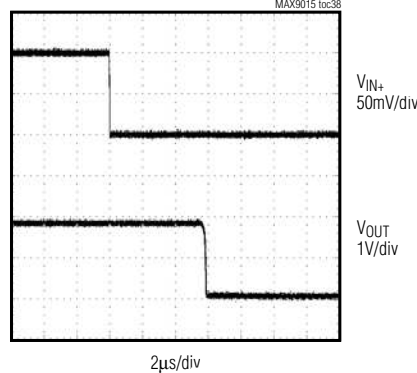

PROPAGATION DELAY ( $t_{PD+}$ ) ( $V_{CC} = 1.8V$ )

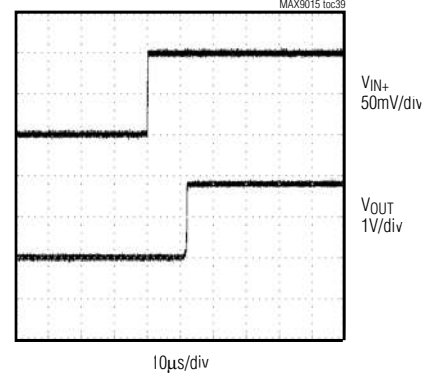

1kHz RESPONSE ( $V_{CC} = 5V$ )

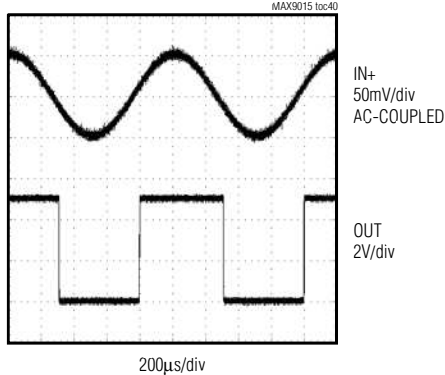

SLOW POWER UP/DOWN RESPONSE

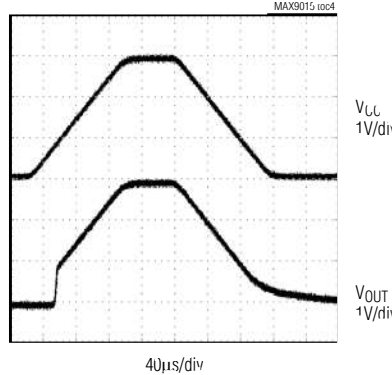

POWER-UP RESPONSE

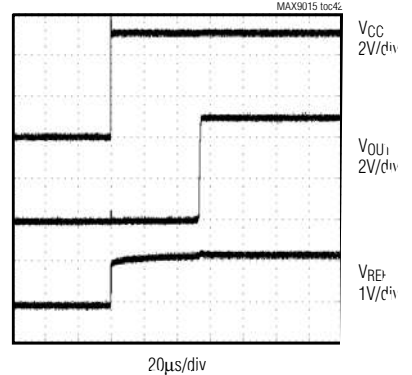

Pin Description

PIN			NAME	FUNCTION
MAX9015/ MAX9016	MAX9017/ MAX9018	MAX9019/ MAX9020		
1	—	—	REF	1.24V Reference Output
2	—	—	IN-	Comparator Inverting Input
3	—	—	IN+	Comparator Noninverting Input
4	4	4	V <sub>EE</sub>	Negative Supply Voltage
5, 8	—	—	N.C.	No Connection. Not internally connected.
6	—	—	OUT	Comparator Output
7	8	8	V <sub>CC</sub>	Positive Supply Voltage
—	1	1	OUTA	Comparator A Output
—	3	3	INA+	Comparator A Noninverting Input
—	5	5	INB+	Comparator B Noninverting Input
—	6	6	INB-	Comparator B Inverting Input
—	7	7	OUTB	Comparator B Output
—	—	2	INA-	Comparator A Inverting Input
—	2	—	REF/ INA-	1.24V Reference Output. Internally connected to the inverting input of comparator A (MAX9017/MAX9018 only).

Functional Diagrams

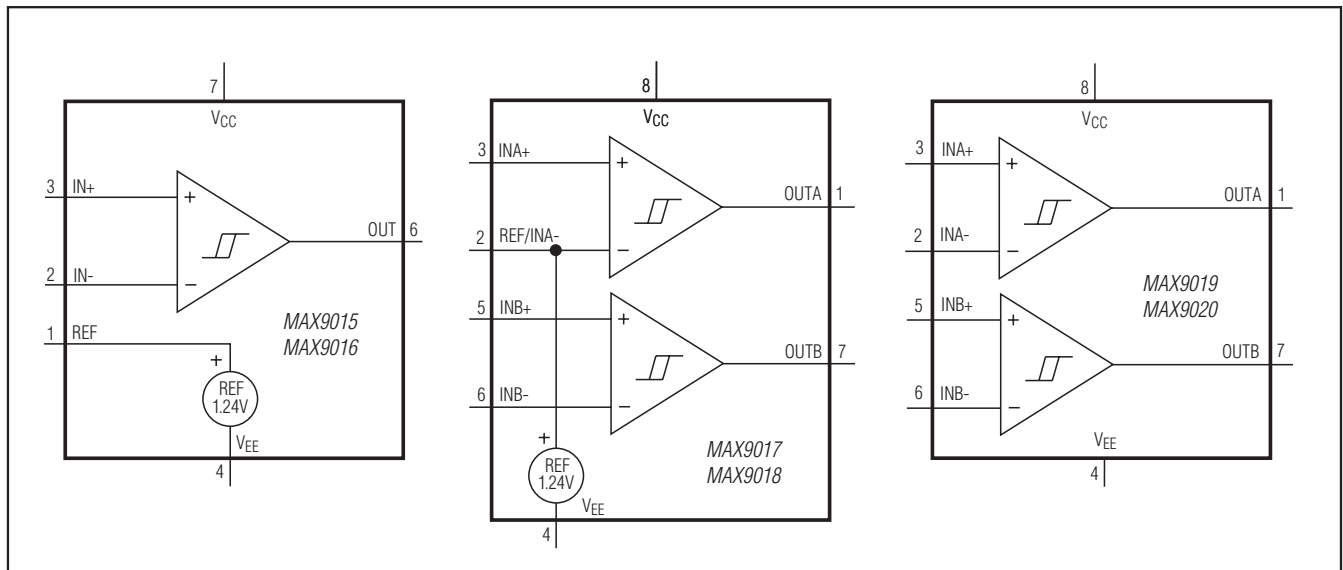

## Detailed Description

The MAX9015–MAX9018 feature an on-board 1.24V  $\pm 0.5\%$  ( $\pm 1.45\%$  for the B grade) reference, yet draw an ultra-low supply current. The MAX9019/MAX9020 (duals without reference) consume just 850nA of supply current. All devices are guaranteed to operate down to 1.8V supply. Their common-mode input voltage range extends 200mV beyond-the-rails. An internal 4mV hysteresis ensures clean output switching, even with slow-moving input signals. Large internal output drivers swing rail-to-rail with up to  $\pm 6\text{mA}$  loads (MAX9015/MAX9017/MAX9019).

The output stage employs a unique design that minimizes supply-current surges while switching, which virtually eliminates the supply glitches typical of many other comparators. The MAX9015/MAX9017/MAX9019 have a push-pull output stage that sinks as well as sources current. The MAX9016/MAX9018/MAX9020 have an open-drain output stage that can be pulled beyond  $V_{CC}$  up to 5.5V above  $V_{EE}$ . These open-drain versions are ideal for implementing wire-ORed output logic functions.

## Input Stage Circuitry

The input common-mode voltage ranges extend from  $V_{EE} - 0.2\text{V}$  to  $V_{CC} + 0.2\text{V}$ . These comparators operate at any differential input voltage within these limits. Input bias current is typically  $\pm 150\text{pA}$  at the trip point, if the input voltage is between the supply rails. Comparator inputs are protected from overvoltage by internal ESD protection diodes connected to the supply rails. As the input voltage exceeds the supply rails, these ESD protection diodes become forward biased and begin to conduct increasing input bias current (see the Input Bias Current vs. Input Bias Voltage graph in the *Typical Operating Characteristics*).

## Output Stage Circuitry

The MAX9015–MAX9020 feature a unique break-before-make output stage capable of driving  $\pm 8\text{mA}$  loads rail-to-rail. Many comparators consume orders of magnitude more current during switching than during steady-state operation. However, with the MAX9015–MAX9020 family of comparators, the supply-current change during an output transition is extremely small. In the *Typical Operating Characteristics*, the Supply Current vs. Output Transition Frequency graphs show the minimal supply-current increase as the output switching frequency approaches 1kHz. This characteristic reduces the need for power-supply filter capacitors to reduce glitches created by comparator switching currents. In battery-powered applications, this characteristic results in a substantial increase in battery life.

## Reference (MAX9015–MAX9018)

The MAX9015–MAX9018s' internal +1.24V reference has a typical temperature coefficient of 40ppm/ $^{\circ}\text{C}$  over the full  $-40^{\circ}\text{C}$  to  $+85^{\circ}\text{C}$  temperature range. The reference is a very-low-power bandgap cell, with a typical  $35\text{k}\Omega$  output impedance. REF can source and sink up to 100nA to external circuitry. For applications needing increased drive, buffer REF with a low input-bias current op amp such as the MAX4162. Most applications require no REF bypass capacitor. For noisy environments or fast transients, connect a 1nF to 10nF ceramic capacitor from REF to GND.

## Applications Information

### Low-Voltage, Low-Power Operation

The MAX9015–MAX9020 are ideally suited for use with most battery-powered systems. Table 1 lists a variety of battery types, capacities, and approximate operating times for the MAX9015–MAX9020, assuming nominal conditions.

**Table 1. Battery Applications Using the MAX9015–MAX9020**

BATTERY TYPE	RECHARGEABLE	V <sub>FRESH</sub> (V)	V <sub>END-OF-LIFE</sub> (V)	CAPACITY, AA SIZE (mA-hr)	MAX9015A/MAX9016A OPERATING TIME (hr)	MAX9017/MAX9018 OPERATING TIME (hr)	MAX9019/MAX9020 OPERATING TIME (hr)
Alkaline (2 cells)	No	3.0	1.8	2000	2000k	1540k	1333k
Nickel-cadmium (2 cells)	Yes	2.4	1.8	750	750k	570k	500k
Nickel-metal-hydride (2 cells)	Yes	2.4	1.8	1000	1000k	770k	660k
Lithium-ion (1 cell)	Yes	3.6	2.9	1000	1000k	770k	660k

**Internal Hysteresis**

Many comparators oscillate in the linear region of operation because of noise or undesired parasitic feedback. Oscillations can occur when the voltage on one input is equal or very close to the voltage on the other input. The MAX9015–MAX9020 have internal 4mV hysteresis to counter parasitic effects and noise.

The hysteresis in a comparator creates two trip points: one for the rising input voltage ( $V_{THR}$ ) and one for the falling input voltage ( $V_{THF}$ ) (Figure 1). The difference between the trip points is the hysteresis ( $V_{HB}$ ). When the comparator’s input voltages are equal, the hysteresis effectively causes one comparator input to move quickly past the other, thus taking the input out of the region where oscillation occurs. Figure 1 illustrates the case in which the comparator’s inverting input has a fixed voltage applied, and the noninverting input is varied. If the inputs were reversed, the figure would be the same, except with an inverted output.

**Additional Hysteresis (MAX9015/MAX9017/MAX9019) (Push-Pull Outputs)**

The MAX9015/MAX9017/MAX9019 feature a built-in 4mV hysteresis band ( $V_{HB}$ ). Additional hysteresis can be generated with three resistors using positive feedback (Figure 2). Use the following procedure to calculate resistor values:

- 1) Select R3. Input bias current at  $IN_{+}$  is less than 2nA, so the current through R3 should be at least 0.2µA to minimize errors caused by input bias current. The current through R3 at the trip point is  $(V_{REF} - V_{OUT})/R3$ . Considering the two possible output states in solving for R3 yields two formulas:  $R3 = V_{REF}/I_{R3}$  or  $R3 = (V_{CC} - V_{REF})/I_{R3}$ . Use the smaller of the two resulting resistor values. For example, when using the MAX9017 ( $V_{REF} = 1.24V$ ) and  $V_{CC} = 5V$ , and if we choose  $I_{R3} = 0.2\mu A$ , then the two resistor values are 6.2MΩ and 19MΩ. Choose a 6.2MΩ standard value for R3.
- 2) Choose the hysteresis band required ( $V_{HB}$ ). For this example, choose 50mV.
- 3) Calculate R1 according to the following equation:

$$R1 = 6.2M\Omega \left( \frac{50mV}{5V} \right) = 12k\Omega$$

For this example, insert the values:

$$R1 = 6.2M\Omega \left( \frac{50mV}{5V} \right) = 12k\Omega$$

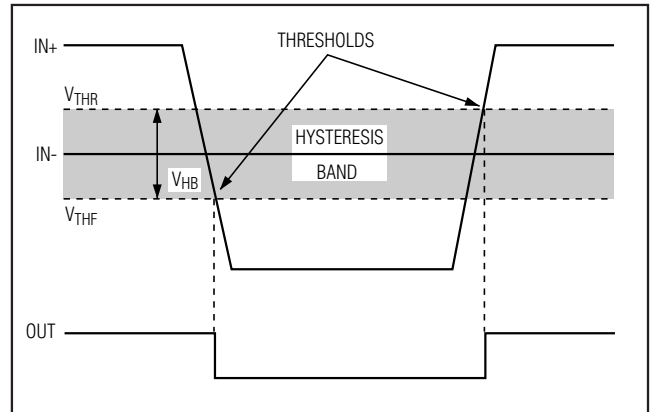

Figure 1. Threshold Hysteresis Band

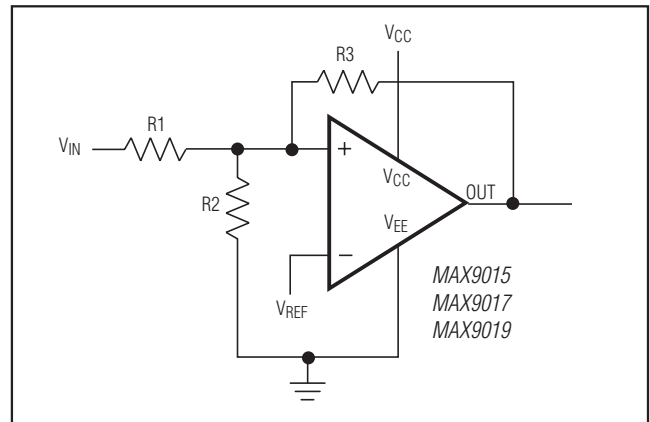

Figure 2. MAX9015/MAX9017/MAX9019 Additional Hysteresis

- 4) Choose the trip point for  $V_{IN}$  rising ( $V_{THR}$ ) such that:

$$V_{THR} > V_{REF} \left( 1 + \frac{V_{HB}}{V_{CC}} \right)$$

where  $V_{THR}$  is the trip point for  $V_{IN}$  rising. This is the threshold voltage at which the comparator switches its output from low to high as  $V_{IN}$  rises above the trip point. For this example, choose 3V.

- 5) Calculate R2 as follows:

$$R2 = \frac{1}{\left[ \left( \frac{V_{THR}}{V_{REF} \times R1} \right) - \left( \frac{1}{R1} \right) - \left( \frac{1}{R3} \right) \right]}$$

$$R2 = \frac{1}{\left[ \left( \frac{3.0V}{(1.24V \times 62k\Omega)} \right) - \left( \frac{1}{62k\Omega} \right) - \left( \frac{1}{6.2M\Omega} \right) \right]} = 43.99k\Omega$$

For this example, choose a 44.2kΩ standard value.

- 6) Verify the trip voltages and hysteresis as follows:  
 $V_{IN}$  rising: = 2.992V, which is equivalent to REF times R1 divided by the parallel combination of R1, R2:

$$V_{THR} = V_{REF} \times R1 \left[ \left( \frac{1}{R1} \right) + \left( \frac{1}{R2} \right) + \left( \frac{1}{R3} \right) \right]$$

and R3.

$V_{IN}$  falling: = 2.942V:

$$V_{THF} = V_{THR} - \left( \frac{R1 \times V_{CC}}{R3} \right)$$

Hysteresis =  $V_{THR} - V_{THF} = 50mV$ .

**Additional Hysteresis  
(MAX9016/MAX9018/MAX9020)  
(Open-Drain Outputs)**

The MAX9016/MAX9018/MAX9020 feature a built-in 4mV hysteresis band. These devices have open-drain outputs and require an external pullup resistor (Figure 3). Additional hysteresis can be generated using positive feedback, but the formulas differ slightly from those of the MAX9015/MAX9017/MAX9019. Use the following procedure to calculate resistor values:

- 1) Select R3. Input bias current at  $IN_{+}$  is less than 2nA, so the current through R3 should be at least 0.2µA to minimize errors caused by input bias current. The current through R3 at the trip point is  $(V_{REF} - V_{OUT})/R3$ . Considering the two possible output states in solving for R3 yields two formulas:  $R3 = V_{REF}/I_{R3}$  or  $R3 = [(V_{CC} - V_{REF})/I_{R3}] - R4$ . Use the smaller of the two resulting resistor values. For example, when using the MAX9018 ( $V_{REF} = 1.24V$ ) and  $V_{CC} = 5V$ , and if we choose  $I_{R3} = 0.2\mu A$ , and  $R4 = 1M\Omega$ , then the two resistor values are 6.2MΩ and 18MΩ. Choose a 6.2MΩ standard value for R3.
- 2) Choose the hysteresis band required ( $V_{HB}$ ).
- 3) Calculate R1 according to the following equation. For this example, insert the values:

$$R1 = (R3 + R4) \left( \frac{V_{HB}}{V_{CC}} \right)$$

$$R1 = (6.2M\Omega + 1M\Omega) \left( \frac{50mV}{5V} \right) = 72k\Omega$$

- 4) Choose the trip point for  $V_{IN}$  rising ( $V_{THR}$ ) such that:

$$V_{THR} > V_{REF} \left( 1 + \frac{V_{HB}}{V_{CC}} \right)$$

( $V_{THR}$  is the trip point for  $V_{IN}$  rising). This is the threshold voltage at which the comparator switches its output from low to high as  $V_{IN}$  rises above the trip point. For this example, choose 3V:

- 5) Calculate R2 as follows:

$$R2 = \frac{1}{\left[ \left( \frac{V_{THR}}{V_{REF} \times R1} \right) - \left( \frac{1}{R1} \right) - \left( \frac{1}{R3} \right) \right]}$$

$$R2 = \frac{1}{\left[ \left( \frac{3.0V}{1.24V \times 72k\Omega} \right) - \left( \frac{1}{72k\Omega} \right) - \left( \frac{1}{6.2M\Omega} \right) \right]} = 51.1k\Omega$$

For this example, choose a 49.9kΩ standard value.

- 6) Verify the trip voltages and hysteresis as follows:

$$V_{IN} \text{ rising: } V_{THR} = V_{REF} \times R1 \left[ \left( \frac{1}{R1} \right) + \left( \frac{1}{R2} \right) + \left( \frac{1}{R3} \right) \right] = 3.043V$$

$$V_{IN} \text{ falling: } V_{THF} = V_{REF} \times R1 \left[ \left( \frac{1}{R1} \right) + \left( \frac{1}{R2} \right) + \left( \frac{1}{R3} \right) \right] - \frac{R1}{R3 + R4} \times V_{CC} = 2.993V$$

Hysteresis =  $V_{THR} - V_{THF} = 50mV$ .

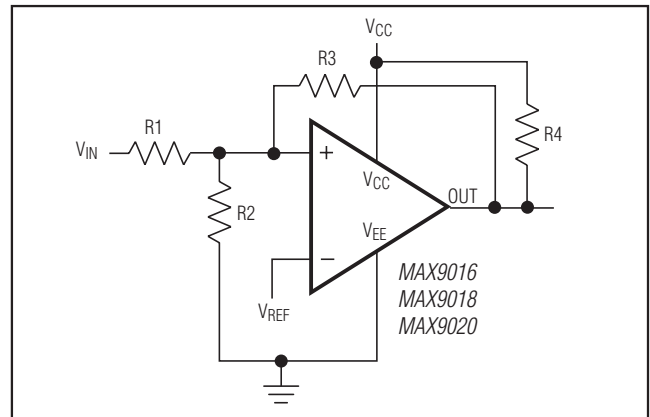

Figure 3. MAX9016/MAX9018/MAX9020 Additional Hysteresis

**Board Layout and Bypassing**

The MAX9015–MAX9020 ultra-low supply current typically requires no power-supply bypass capacitors. However, when the supply has high output impedance, long lead lengths or excessive noise, or fast transients, bypass V<sub>CC</sub> to V<sub>EE</sub> with a 0.1µF capacitor placed as close to the V<sub>CC</sub> pin as possible. Minimize signal trace lengths to reduce stray capacitance. Use a ground plane and surface-mount components for best performance. If REF is decoupled, use a low-leakage ceramic capacitor. High traces should not be routed in the vicinity of or below MAX9018. There is a chance of voltage reference being overloaded resulting in drop of output voltage.

**Window Detector**

The MAX9018 is ideal for window detectors (undervoltage/overvoltage detectors). Figure 4 shows a window detector circuit for a single-cell Li+ battery with a 2.9V end-of-life charge, a peak charge of 4.2V, and a nominal value of 3.6V. Choose different thresholds by changing the values of R1, R2, and R3. OUTA provides an active-low undervoltage indication, and OUTB provides an active-low overvoltage indication. ANDing the two open-drain outputs provides an active-high, power-good signal.

**The design procedure is as follows:**

- 1) Select R1. The input bias current into INB- is normally less than 2nA, so the current through R1 should exceed 100nA for the thresholds to be accurate. In this example, choose R1 = 1.24MΩ (1.24V/1µA).
- 2) Calculate R2 + R3. The overvoltage threshold should be 4.2V when V<sub>IN</sub> is rising. The design equation is as follows:

$$R2 + R3 = R1 \times \left[ \left( \frac{V_{OTH}}{V_{REF} + V_{HB}} \right) - 1 \right]$$

$$= 1.24M\Omega \times \left[ \left( \frac{4.2V}{1.24V + 0.004} \right) - 1 \right]$$

$$= 2.95M\Omega$$

- 3) Calculate R2. The undervoltage threshold should be 2.9V when V<sub>IN</sub> is falling. The design equation is as follows:

$$R2 = (R1 + R2 + R3) \times \left( \frac{V_{REF} - V_{HB}}{V_{UTH}} \right) - R1$$

$$= (1.24M\Omega + 2.95M\Omega) \times \frac{(1.236)}{2.9} - 1.24M\Omega$$

$$= 546k\Omega$$

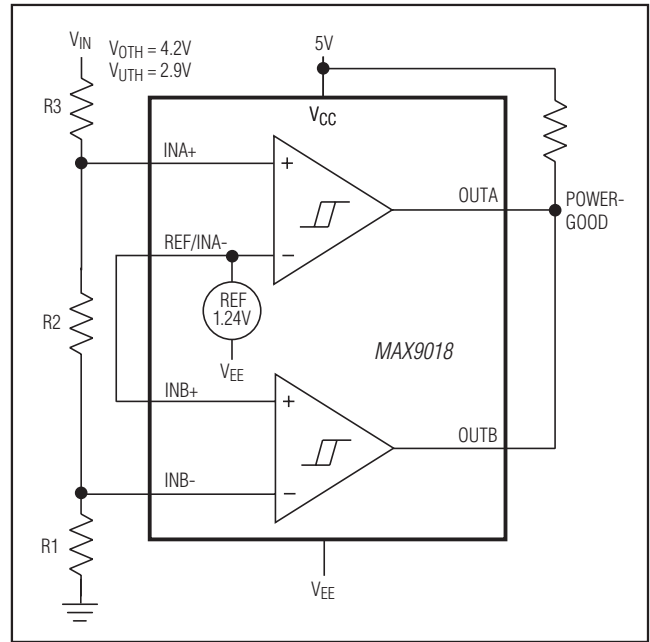

Figure 4. Window Detector Circuit

For this example, choose a 499kΩ standard value 1% resistor.

- 4) Calculate R3:

$$R3 = (R2 + R3) - R2$$

$$= 2.95M\Omega - 546k\Omega$$

$$= 240M\Omega$$

- 5) Verify the resistor values. The equations are as follows, evaluated for the above example:

Overvoltage threshold:

$$V_{OTH} = (V_{REF} + V_{HB}) \times \frac{(R1 + R2 + R3)}{R1} = 4.20V$$

Undervoltage threshold:

$$V_{UTH} = (V_{REF} - V_{HB}) \times \frac{(R1 + R2 + R3)}{(R1 + R2)} = 2.97V$$

where the internal hysteresis band, V<sub>HB</sub>, is 4mV.

**Zero-Crossing Detector**

Figure 5 shows a zero-crossing detector application. The MAX9015/MAX9016/MAX9019/MAX9020s' inverting input is connected to ground, and its noninverting input is connected to a 100mV<sub>P-P</sub> signal source. As the signal at the noninverting input crosses zero, the comparator's output changes state.



**Logic-Level Translator**

The open-drain comparators can be used to convert 5V logic to 3V logic levels. The MAX9020 can be powered by the 5V supply voltage, and the pullup resistor for the MAX9020's open-drain output is connected to the 3V supply voltage. This configuration allows the full 5V logic swing without creating overvoltage on the 3V logic inputs. For 3V to 5V logic-level translations, connect the 3V supply voltage to VCC and the 5V supply voltage to the pullup resistor.

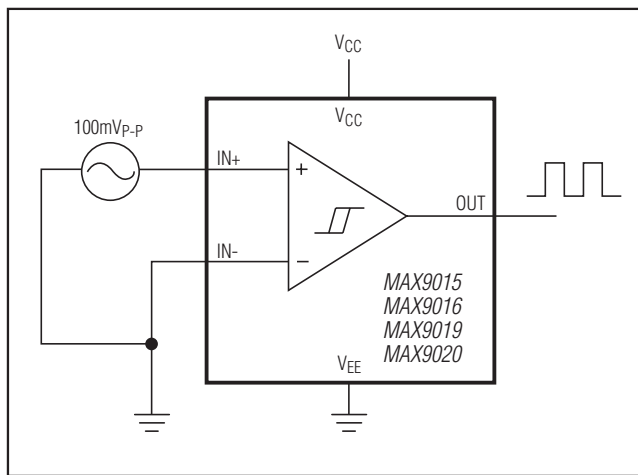
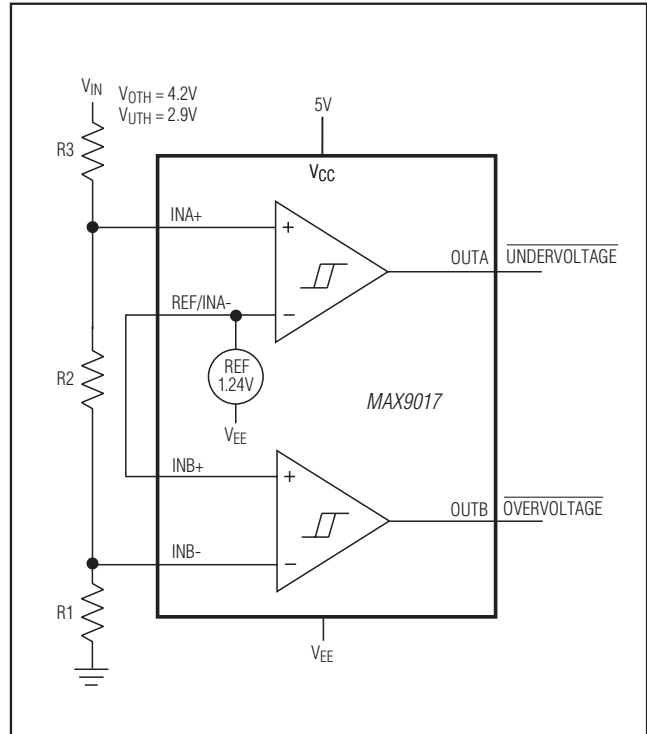
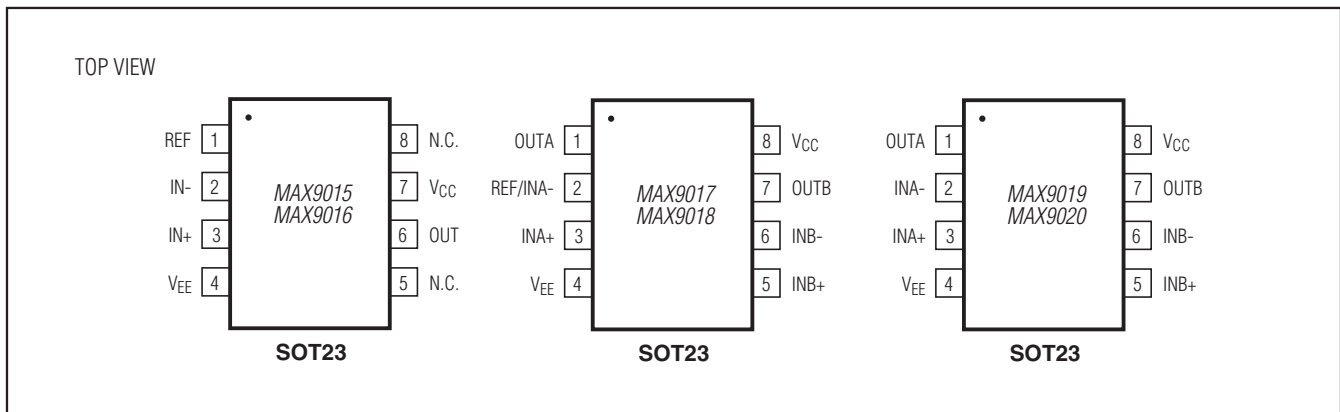

Figure 5. Zero-Crossing Detector

**Typical Application Circuit**



**Pin Configurations**



# MAX9015–MAX9020

## SOT23, Dual, Precision, 1.8V, Nanopower Comparators With/Without Reference

### Ordering Information (continued)

PART	TEMP RANGE	PIN- PACKAGE	TOP MARK
MAX9018AEKA-T	-40°C to +85°C	8 SOT23	AEIR
MAX9018BEKA-T	-40°C to +85°C	8 SOT23	AEIT
MAX9019EKA-T	-40°C to +85°C	8 SOT23	AEIU
MAX9020EKA-T	-40°C to +85°C	8 SOT23	AEIV

T = Tape and reel.

### Chip Information

TRANSISTOR COUNT: 349

PROCESS: BiCMOS

### Package Information

For the latest package outline information and land patterns (footprints), go to [www.maximintegrated.com/packages](http://www.maximintegrated.com/packages). Note that a "+", "#", or "-" in the package code indicates RoHS status only. Package drawings may show a different suffix character, but the drawing pertains to the package regardless of RoHS status.

PACKAGE TYPE	PACKAGE CODE	OUTLINE NO.	LAND PATTERN NO.
8 SOT23	K8-5	<a href="#">21-0078</a>	<a href="#">90-0176</a>



## Revision History

REVISION NUMBER	REVISION DATE	DESCRIPTION	PAGES CHANGED
2	12/09	Updated EC table parameters after final test changes	2, 4
3	10/13	Added Note 5 to <i>Electrical Characteristics</i> and revised <i>Board Layout and Bypassing</i> section	5, 14
4	1/15	Added MAX9015AEKA/V+T to <i>Ordering Information</i>	2

Maxim Integrated cannot assume responsibility for use of any circuitry other than circuitry entirely embodied in a Maxim Integrated product. No circuit patent licenses are implied. Maxim Integrated reserves the right to change the circuitry and specifications without notice at any time. The parametric values (min and max limits) shown in the Electrical Characteristics table are guaranteed. Other parametric values quoted in this data sheet are provided for guidance.