

Pb Free Plating Product

FR1001CT thru FR1007CT



10.0 Ampere Heatsink Dual Common Cathode Fast Recovery Rectifiers

Features

- * Fast switching for high efficiency
- * Low forward voltage drop
- * High current capability
- * Low reverse leakage current
- * High surge current capability

Application

- * Automotive Inverters/Solar Inverters
- * Plating Power Supply, SMPS and UPS
- * Car Audio Amplifiers and Sound Device Systems

Mechanical Data

- * Case: Heatsink TO-220AB
- * Epoxy: UL 94V-0 rate flame retardant
- * Terminals: Solderable per MIL-STD-202 method 208
- * Polarity: As marked on diode body
- * Mounting position: Any
- * Weight: 2.1 gram approxiamtely

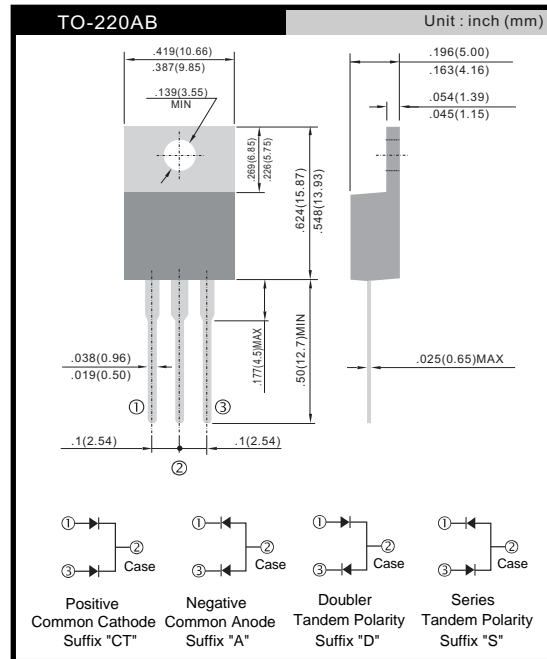
**Maximum Ratings and Electrical Characteristics**

Ratings at 25°C ambient temperature unless otherwise specified.

Single phase, half wave, 60Hz, resistive or inductive load.

For capacitive load, derate current by 20%.

	Symbols	FR1001CT	FR1002CT	FR1003CT	FR1004CT	FR1005CT	FR1006CT	FR1007CT	Units
Maximum Recurrent Peak Reverse Voltage	V_{RRM}	50	100	200	400	600	800	1000	Volts
Maximum RMS Voltage	V_{RMS}	35	70	140	280	420	560	700	Volts
Maximum DC Blocking Voltage	V_{DC}	50	100	200	400	600	800	1000	Volts
Maximum Average Forward Rectified Current See Fig. 2	$I_{(AV)}$	10.0							Amp
Peak Forward Surge Current, 8.3ms single half-sine-wave superimposed on rated load (JEDEC method)	I_{FSM}	125							Amp
Maximum Forward Voltage at 5.0A DC and 25°C	V_F	1.3							Volts
Maximum Reverse Current at $T_C=25^\circ\text{C}$ at Rated DC Blocking Voltage $T_C=125^\circ\text{C}$	I_R	5.0 100							uAmp
Typical Thermal Resistance (Note 1)	$R_{\theta JC}$	3							°C/W
Maximum Reverse Recovery Time (Note 2)	T_{RR}	150				250	500		nS
Operating and Storage Temperature Range	T_J, T_{stg}	-55 to +150							°C

NOTES:

1- Thermal Resistance from Junction to Case per Leg Mounted on Heatsink.

2- Reverse Recovery Test Conditions: $I_F=5A$, $I_R=1A$, $I_{RR}=.25A$.

RATINGS AND CHARACTERISTIC CURVES

FIG. 1- REVERSE RECOVERY TIME CHARACTERISTIC AND TEST CIRCUIT DIAGRAM

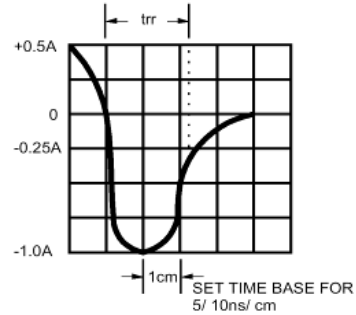
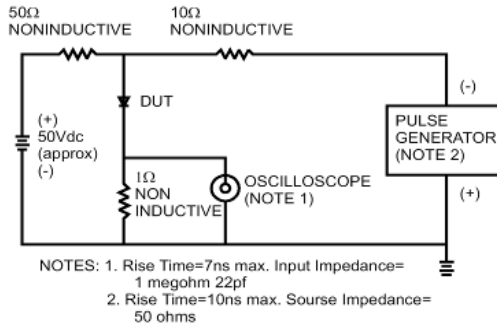

FIG.2- MAXIMUM FORWARD CURRENT DERATING CURVE

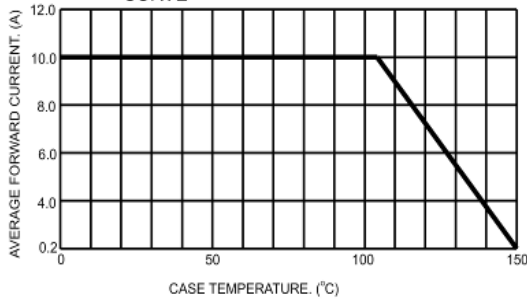

FIG.5- TYPICAL REVERSE CHARACTERISTICS PER LEG

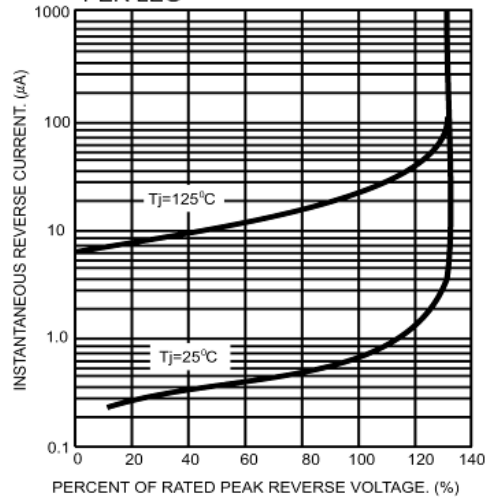

FIG.3- MAXIMUM NON-REPETITIVE FORWARD SURGE CURRENT PER LEG

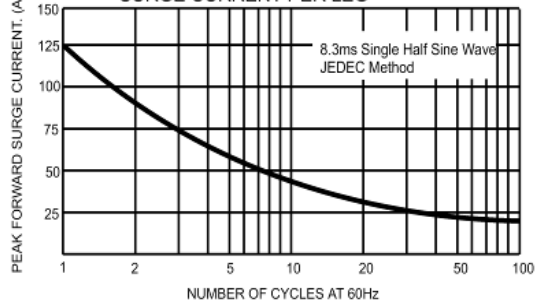

FIG.6- TYPICAL INSTANTANEOUS FORWARD CHARACTERISTICS PER LEG

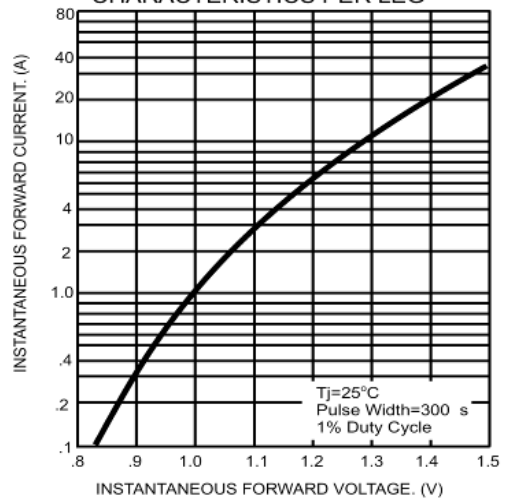

FIG.4- TYPICAL JUNCTION CAPACITANCE PER LEG

