

DRAFT SPECIFICATION

PATENT PENDING

- Part No. : **MA950.A.LBICG.005**
- Product Name : MA950 Guardian 5in1 Adhesive Mount Antenna
 LTE*2+Wi-Fi*2+GNSS
- Features : Low-profile Housing – Mounts flush to Wall
 2* LTE MIMO 698-960MHz/1710-2170MHz/
 2490-2690MHz/ 3300-3600MHz
 2* Wi-Fi MIMO 2.4GHz/5.8GHz
 1* GPS-GLONASS-GALILEO-BeiDou Antenna
 Worldwide 4G Bands including 3G and 2G
 IP67 Waterproof Enclosure
 Dims: 146*134*20mm
 1M Low Loss KSR200-P and RG174 with
 SMA(M)/RP-SMA(M) connectors
 Cables and Connectors Customizable
RoHS Compliant

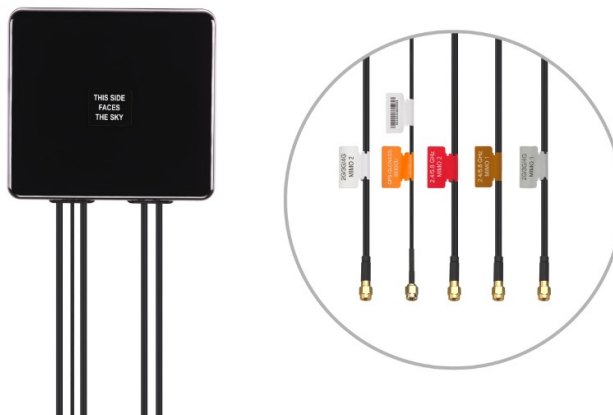

1. Introduction

The MA950 Guardian is a next generation combination antenna. The first panel antenna worldwide designed for IoT Gateway and Router devices. It is a low profile 5in1 wall and adhesive mount antenna. This heavy-duty, fully IP67 waterproof external M2M antenna can be used by RF professionals in IoT Gateway and Routers, HD Video Streaming, Transportation and Remote Monitoring Applications

This antenna delivers powerful MIMO antenna technology for worldwide 4G LTE bands at 698-960MHz/1710-2170MHz/2490-2690MHz/3300-3600MHz bands, dual-band 2.4/5.8GHz Wi-Fi, plus GPS-GLONASS-GALILEO-BeiDou for location accuracy. It enables designers to cover a wide range of technologies by installing a single antenna.

4G wireless applications demand high speed data uplink and downlink. High efficiency and high gain MIMO antennas are necessary to achieve the required signal to noise ratio and throughput required to solve these challenges. Taoglas also takes care to have high isolation among these antennas to prevent self-interference. Low loss cables are used to keep efficiency high over long cable lengths.

The GPS-GLONASS-GALILEO-BeiDou active antenna has been carefully designed for excellent performance across all GNSS bands, leading to higher location accuracy and stability of tracking in urban environments.

The housing is IP67 waterproof and comes with 3M foam adhesive. The antenna can be mounted internally or externally on a vehicle. The MA950 comes with 1 meter, low loss KSR-200P coaxial cables for the LTE and Wi-Fi antennas, and RG174 coaxial cable for the GNSS antenna as standard. Customized cables and connector versions are also available.

2. Specification

GPS-GLONASS-GALILEO-BeiDou				
Center Frequency	GPS/GALILEO:1575.42±1.023MHz BeiDou:1561.098±2.046MHz GLONASS:1602±5MHz			
Passive Antenna Efficiency (without cable loss)	GPS/GALILEO: 48% GLONASS: 57% BeiDou: 63%			
Passive Antenna Average Gain (without cable loss)	GPS/GALILEO: -3.13dBi GLONASS: -2.39dBi BeiDou: -1.97dBi			
Passive Antenna Peak Gain (without cable loss)	GPS/GALILEO: 1.98dBi GLONASS: 3.01dBi BeiDou: 3dBi			
VSWR	3:1 Max			
Impedance	50Ω			
Axial Ratio	GPS/GALILEO:<14.02 GLONASS:<5.9 BeiDou:<9.7			
Polarization	RHCP			
Cable	1 meter RG174 standard, fully customizable			
Connector	SMA(M) standard, fully customizable			
LNA and Filter Electrical Properties				
Center Frequency	GPS/GALILEO:1575.42±1.023MHz GLONASS:1602±5MHz BeiDou: 1561.098±2.046MHz			
Output Impedance	50Ω			
VSWR	< 2:1			
Return Loss	10dB Min.			
LNA Gain, Current Draw, and Noise Figure@GPS	Voltage	LNA Gain (Typ)	Current Draw (Typ)	Noise Figure (Typ)
	Min 1.8V	28dB	7.9mA	1.13dB
	Typ 3.0V	30dB	9.0mA	1.13dB
	Max 5.5V	33dB	9.9mA	1.14dB
Total Specification (Through Antenna, SAW Filter, and LNA)				
Frequency	1561.098±2.046MHz	1575.42±1.023MHz	1602±5MHz	
Gain@3V	1561MHz:28±3dBi	1575.42MHz:28±3dBi	1602MHz:28±3dBi	
Output Impedance	50Ω			

4G/3G/2G LTE Antenna

Frequency (MHz)		LTE700	GSM850	GSM900	DCS	PCS	UMTS1	LTE2600	LTE3500
		698~803	824~894	880~960	1710~1880	1850~1990	1920~2170	2490~2690	3300~3600
Efficiency (%)									
MIMO_1	Free space	50.82	55.85	41.29	66.47	70.19	71.51	49.20	50.92
	ABS	68.31	69.61	61.27	66.31	70.86	70.00	50.61	51.88
	Glass	67.99	67.37	62.94	66.89	71.80	69.58	51.00	52.83
	Metal	42.12	51.55	58.33	39.49	47.20	47.71	44.36	44.85
	Wall	67.97	70.42	66.80	63.91	64.94	63.35	50.37	51.49
MIMO_2	Free space	54.13	58.97	48.65	61.54	68.31	68.39	54.62	52.55
	ABS	71.74	66.05	58.58	63.18	69.29	69.23	53.95	54.95
	Glass	64.53	55.70	45.22	64.94	67.87	65.86	50.05	51.77
	Metal	55.62	63.13	56.59	32.14	40.89	43.97	54.22	52.90
	Wall	61.91	48.38	52.88	58.00	56.47	56.36	54.68	48.72
Average Gain (dBi)									
MIMO_1	Free space	-2.96	-2.62	-3.85	-1.78	-1.54	-1.46	-3.12	-2.96
	ABS	-1.68	-1.59	-2.13	-1.79	-1.50	-1.55	-3.00	-2.87
	Glass	-1.73	-1.73	-2.02	-1.75	-1.44	-1.58	-2.96	-2.79
	Metal	-3.94	-2.88	-2.37	-4.07	-3.27	-3.23	-3.57	-3.51
	Wall	-1.70	-1.53	-1.76	-1.95	-1.88	-1.99	-3.00	-2.89
MIMO_2	Free space	-2.72	-2.32	-3.17	-2.11	-1.66	-1.66	-2.65	-2.83
	ABS	-1.47	-1.81	-2.33	-2.00	-1.59	-1.60	-2.71	-2.63
	Glass	-1.93	-2.56	-3.46	-1.88	-1.68	-1.82	-3.04	-2.87
	Metal	-2.61	-2.00	-2.50	-4.95	-3.90	-3.59	-2.67	-2.77
	Wall	-2.09	-3.15	-2.79	-2.37	-2.48	-2.50	-2.63	-3.15
Peak Gain (dBi)									
MIMO_1	Free space	3.18	3.60	2.14	3.98	4.37	4.37	3.70	4.49
	ABS	4.65	4.00	3.45	5.24	6.05	6.05	4.69	3.18
	Glass	3.71	3.92	4.35	5.28	6.16	7.67	5.34	3.87
	Metal	5.09	3.10	4.73	4.50	4.96	5.69	6.02	4.96
	Wall	4.74	4.97	3.67	5.44	4.84	4.84	5.08	3.75
MIMO_2	Free space	5.83	3.66	2.57	3.78	4.01	4.01	3.87	3.97
	ABS	4.33	4.52	4.41	4.34	4.73	5.69	5.64	5.42
	Glass	3.02	3.14	1.36	4.99	5.89	6.02	6.18	4.42
	Metal	3.54	3.11	3.33	3.12	4.36	5.02	7.16	4.95
	Wall	3.21	1.77	2.15	5.49	5.49	7.20	6.10	4.74
Impedance				50Ω					
Polarization				Linear					
VSWR				< 3					
Cable				1 meter KSR200-P standard, fully customizable					
Connector				SMA(M) standard, fully customizable					

2.4GHz/5.8GHz Wi-Fi Antenna			
Frequency (MHz)		2400~2500	4900~5850
Efficiency (%)			
MIMO_1	Free space	57.73	48.06
	ABS	53.59	49.42
	Glass	53.98	47.16
	Metal	51.80	46.70
	Wall	61.02	46.29
MIMO_2	Free space	44.09	47.04
	ABS	46.34	46.79
	Glass	40.79	46.88
	Metal	45.58	45.59
	Wall	50.62	43.60
Average Gain (dBi)			
MIMO_1	Free space	-2.39	-3.25
	ABS	-2.71	-3.13
	Glass	-2.68	-3.36
	Metal	-2.86	-3.44
	Wall	-2.15	-3.42
MIMO_2	Free space	-3.57	-3.33
	ABS	-3.37	-3.36
	Glass	-3.91	-3.35
	Metal	-3.45	-3.52
	Wall	-2.96	-3.67
Peak Gain (dBi)			
MIMO_1	Free space	4.35	4.84
	ABS	5.34	5.18
	Glass	2.99	5.03
	Metal	5.22	5.98
	Wall	5.47	5.77
MIMO_2	Free space	2.94	5.70
	ABS	2.18	5.43
	Glass	3.75	7.07
	Metal	6.02	6.76
	Wall	3.23	5.97
Impedance	50Ω		
Polarization	Linear		
VSWR	< 3		
Cable	1 meter KSR200-P standard, fully customizable		
Connector	RP-SMA(M) standard, fully customizable		

MECHANICAL	
Antenna Dimensions	146*134*20mm
Casing	ASA
Weight (including cable)	640g
Ingress Protection Rating	IP67
ENVIRONMENTAL	
Operation Temperature	-40°C to 85°C
Storage Temperature	-40°C to 90°C
Humidity	Non-condensing 65°C 95% RH

2.1. LTE Bands Covered while on metal Ground Plane

LTE BANDS				
Band Number	LTE / LTE-Advanced / WCDMA / HSPA / HSPA+ / TD-SCDMA			
	Uplink	Downlink	MIMO 1	MIMO 2
1	UL: 1920 to 1980	DL: 2110 to 2170	✓	✓
2	UL: 1850 to 1910	DL: 1930 to 1990	✓	✓
3	UL: 1710 to 1785	DL: 1805 to 1880	✓	✓
4	UL: 1710 to 1755	DL: 2110 to 2155	✓	✓
5	UL: 824 to 849	DL: 869 to 894	✓	✓
7	UL: 2500 to 2570	DL: 2620 to 2690	✓	✓
8	UL: 880 to 915	DL: 925 to 960	✓	✓
9	UL: 1749.9 to 1784.9	DL: 1844.9 to 1879.9	✓	✓
11	UL: 1427.9 to 1447.9	DL: 1475.9 to 1495.9	✗	✗
12	UL: 699 to 716	DL: 729 to 746	✓	✓
13	UL: 777 to 787	DL: 746 to 756	✓	✓
14	UL: 788 to 798	DL: 758 to 768	✓	✓
17	UL: 704 to 716	DL: 734 to 746 (LTE only)	✓	✓
18	UL: 815 to 830	DL: 860 to 875 (LTE only)	✓	✓
19	UL: 830 to 845	DL: 875 to 890	✓	✓
20	UL: 832 to 862	DL: 791 to 821	✓	✓
21	UL: 1447.9 to 1462.9	DL: 1495.9 to 1510.9	✗	✗
22	UL: 3410 to 3490	DL: 3510 to 3590	✓	✓
23	UL: 2000 to 2020	DL: 2180 to 2200 (LTE only)	✓	✓
24	UL: 1625.5 to 1660.5	DL: 1525 to 1559 (LTE only)	✓	✗
25	UL: 1850 to 1915	DL: 1930 to 1995	✓	✓
26	UL: 814 to 849	DL: 859 to 894	✓	✓
27	UL: 807 to 824	DL: 852 to 869 (LTE only)	✓	✓
28	UL: 703 to 748	DL: 758 to 803 (LTE only)	✓	✓
29	UL: -	DL: 717 to 728 (LTE only)	✓	✓
30	UL: 2305 to 2315	DL: 2350 to 2360 (LTE only)	✓	✓
31	UL: 452.5 to 457.5	DL: 462.5 to 467.5 (LTE only)	✗	✗
32	UL: -	DL: 1452 - 1496	✗	✗
35		1850 to 1910	✓	✓
38		2570 to 2620	✓	✓
39		1880 to 1920	✓	✓
40		2300 to 2400	✓	✓
41		2496 to 2690	✓	✓
42		3400 to 3600	✓	✓
43		3600 to 3800	✓	✓

*Covered bands represent an efficiency greater than 20%

2.2. LTE Bands Covered in Free Space

LTE BANDS				
Band Number	LTE / LTE-Advanced / WCDMA / HSPA / HSPA+ / TD-SCDMA			
	Uplink	Downlink	MIMO 1	MIMO 2
1	UL: 1920 to 1980	DL: 2110 to 2170	✓	✓
2	UL: 1850 to 1910	DL: 1930 to 1990	✓	✓
3	UL: 1710 to 1785	DL: 1805 to 1880	✓	✓
4	UL: 1710 to 1755	DL: 2110 to 2155	✓	✓
5	UL: 824 to 849	DL: 869 to 894	✓	✓
7	UL: 2500 to 2570	DL: 2620 to 2690	✓	✓
8	UL: 880 to 915	DL: 925 to 960	✓	✓
9	UL: 1749.9 to 1784.9	DL: 1844.9 to 1879.9	✓	✓
11	UL: 1427.9 to 1447.9	DL: 1475.9 to 1495.9	✗	✗
12	UL: 699 to 716	DL: 729 to 746	✓	✓
13	UL: 777 to 787	DL: 746 to 756	✓	✓
14	UL: 788 to 798	DL: 758 to 768	✓	✓
17	UL: 704 to 716	DL: 734 to 746 (LTE only)	✓	✓
18	UL: 815 to 830	DL: 860 to 875 (LTE only)	✓	✓
19	UL: 830 to 845	DL: 875 to 890	✓	✓
20	UL: 832 to 862	DL: 791 to 821	✓	✓
21	UL: 1447.9 to 1462.9	DL: 1495.9 to 1510.9	✗	✗
22	UL: 3410 to 3490	DL: 3510 to 3590	✓	✓
23	UL: 2000 to 2020	DL: 2180 to 2200 (LTE only)	✓	✓
24	UL: 1625.5 to 1660.5	DL: 1525 to 1559 (LTE only)	✓	✓
25	UL: 1850 to 1915	DL: 1930 to 1995	✓	✓
26	UL: 814 to 849	DL: 859 to 894	✓	✓
27	UL: 807 to 824	DL: 852 to 869 (LTE only)	✓	✓
28	UL: 703 to 748	DL: 758 to 803 (LTE only)	✓	✓
29	UL: -	DL: 717 to 728 (LTE only)	✓	✓
30	UL: 2305 to 2315	DL: 2350 to 2360 (LTE only)	✓	✓
31	UL: 452.5 to 457.5	DL: 462.5 to 467.5 (LTE only)	✗	✗
32	UL: -	DL: 1452 - 1496	✓	✓
35		1850 to 1910	✓	✓
38		2570 to 2620	✓	✓
39		1880 to 1920	✓	✓
40		2300 to 2400	✓	✓
41		2496 to 2690	✓	✓
42		3400 to 3600	✓	✓
43		3600 to 3800	✓	✓

*Covered bands represent an efficiency greater than 20%

3. Antenna Characteristics

3.1. GPS-GLONASS-GALILEO-BeiDou

3.1.1. Block Diagram (Active antenna)

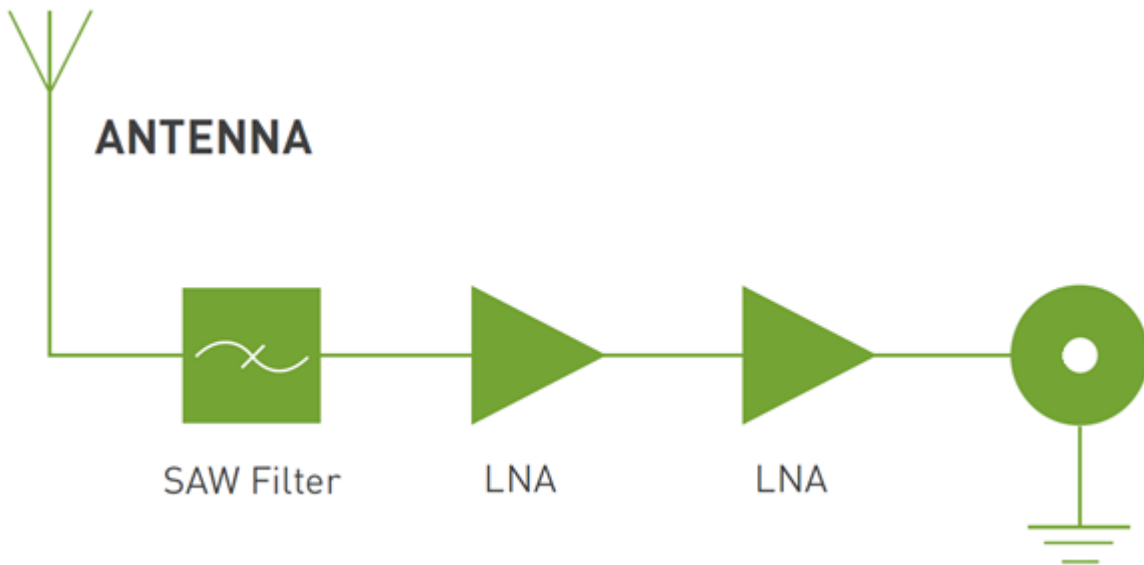

3.1.2. Test Setup

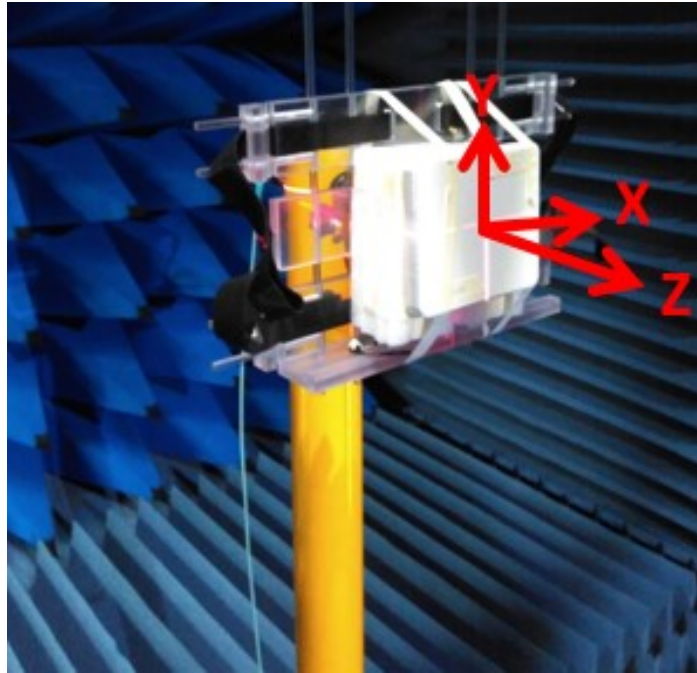

3.1.3. GPS-GLONASS-GALILEO-BeiDou Return Loss (Passive antenna)

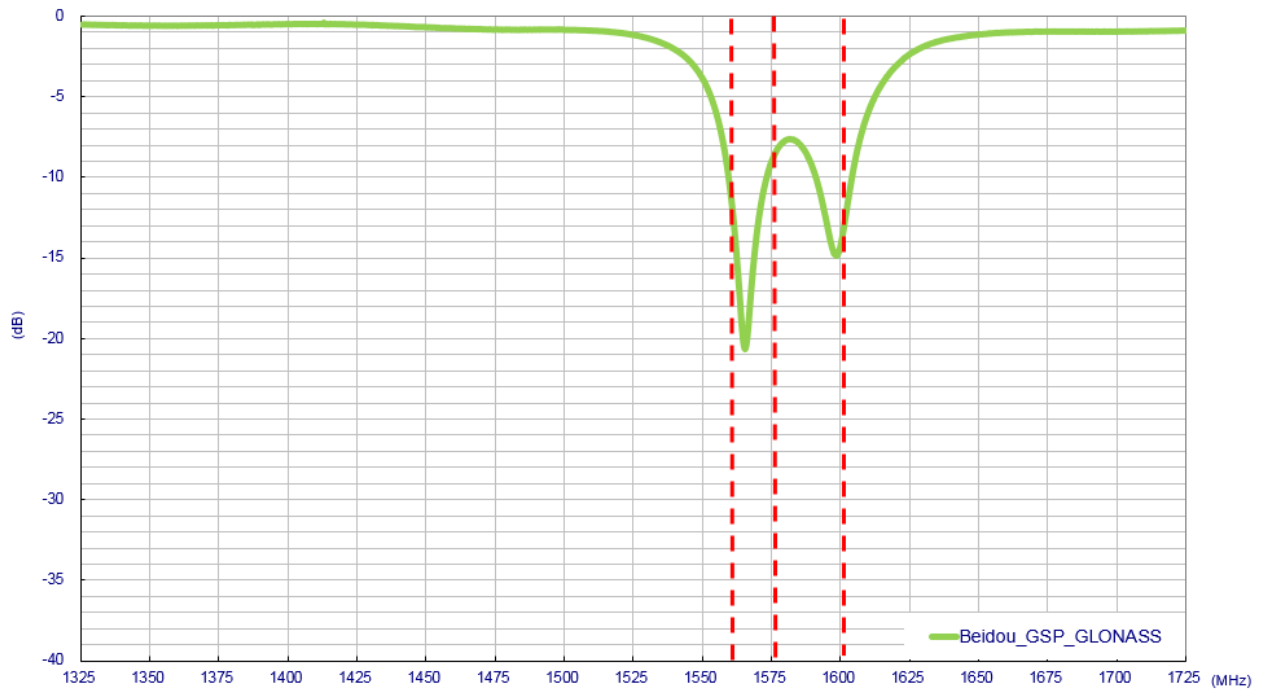

3.1.4. GPS-GLONASS-GALILEO-BeiDou Smith Chart (Passive antenna)

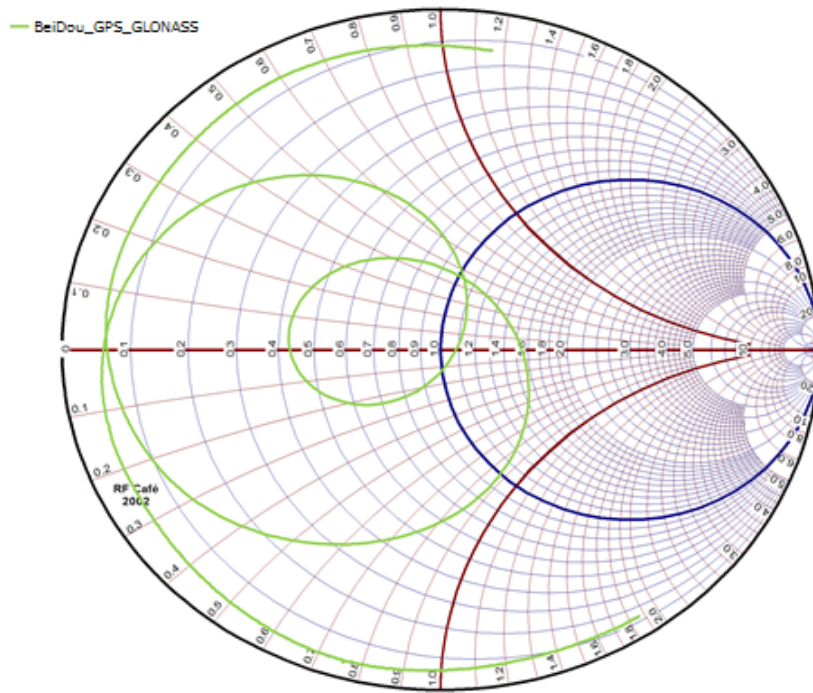

3.1.5. GPS-GLONASS-GALILEO-BeiDou Efficiency (Passive antenna)

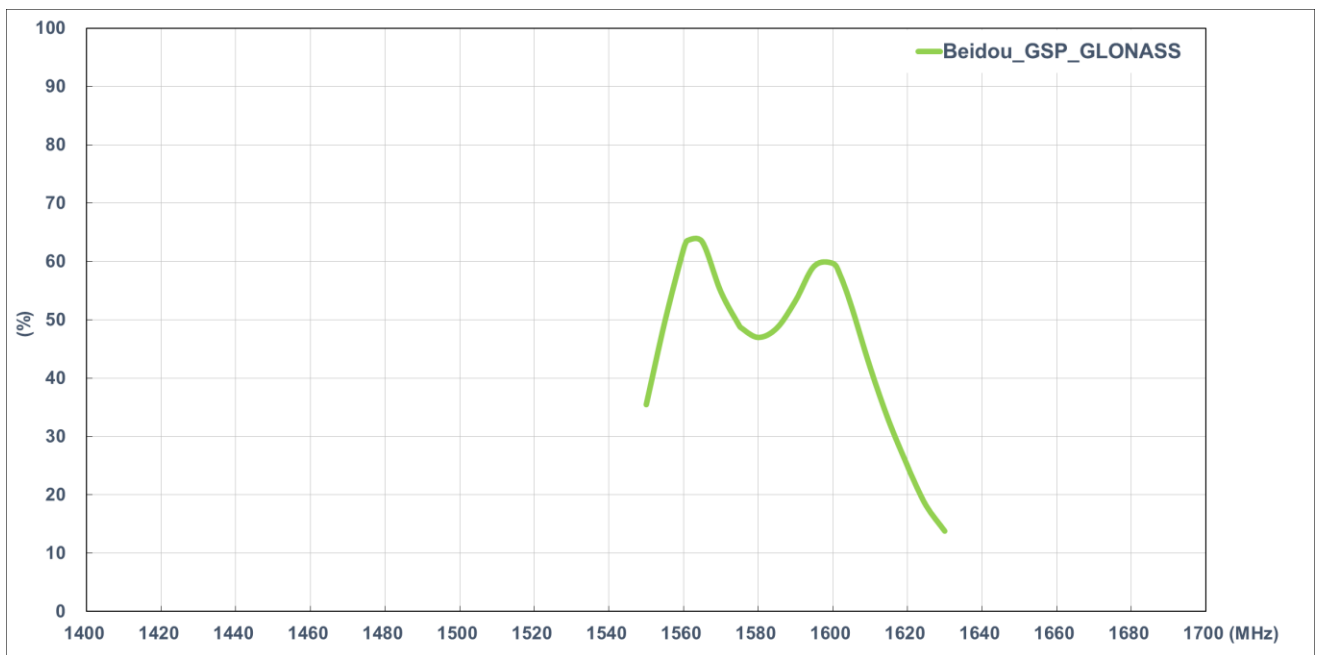

3.1.6. GPS-GLONASS-GALILEO-BeiDou Peak Gain (Passive antenna)

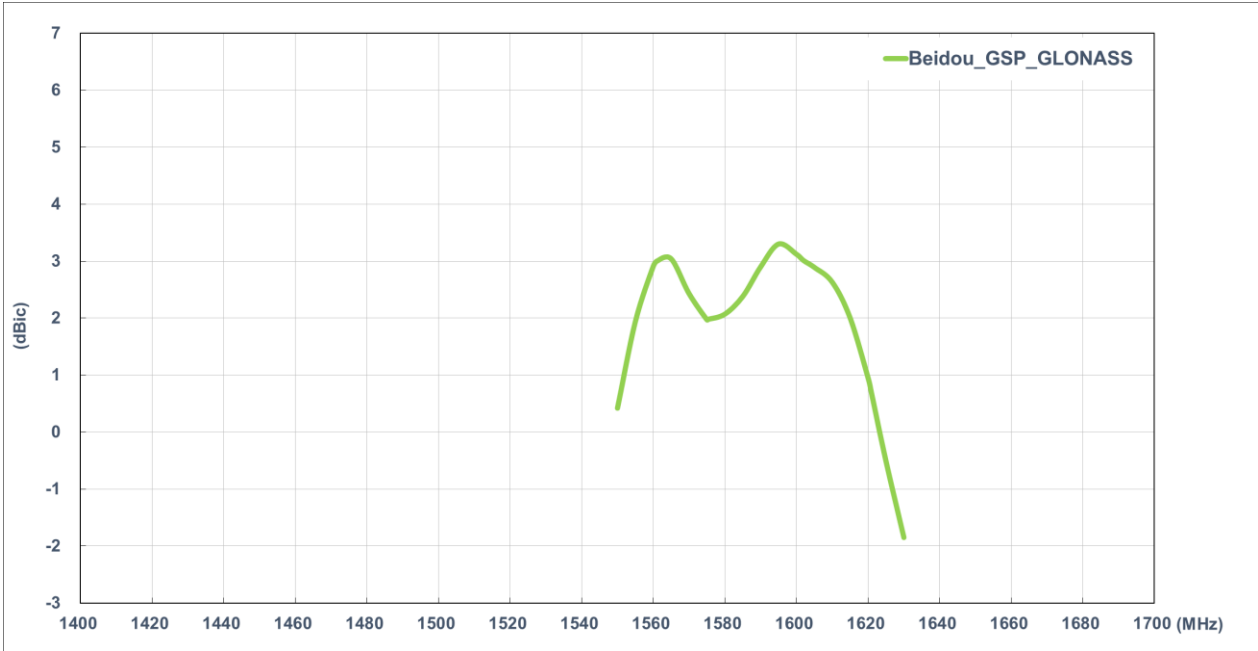

3.1.7. GPS-GLONASS-GAILEO-BeiDou Average Gain (Passive antenna)

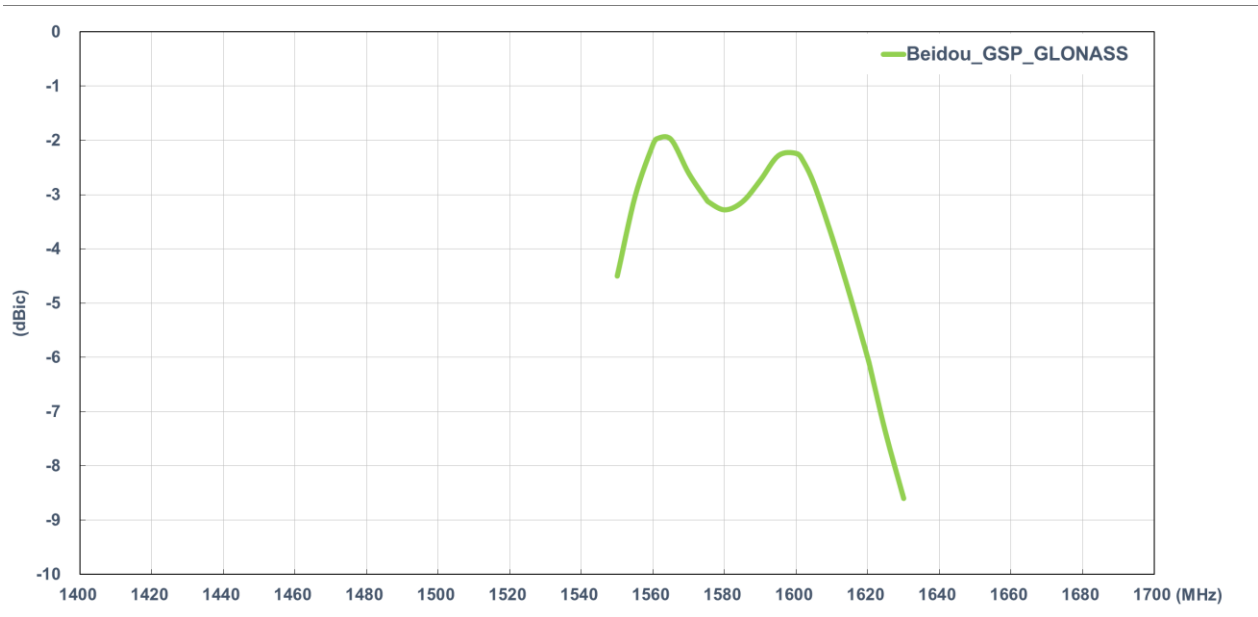

3.1.8. GPS-GLONASS-GALILEO-BeiDou Radiation Pattern (Passive antenna) 2D Radiation Pattern

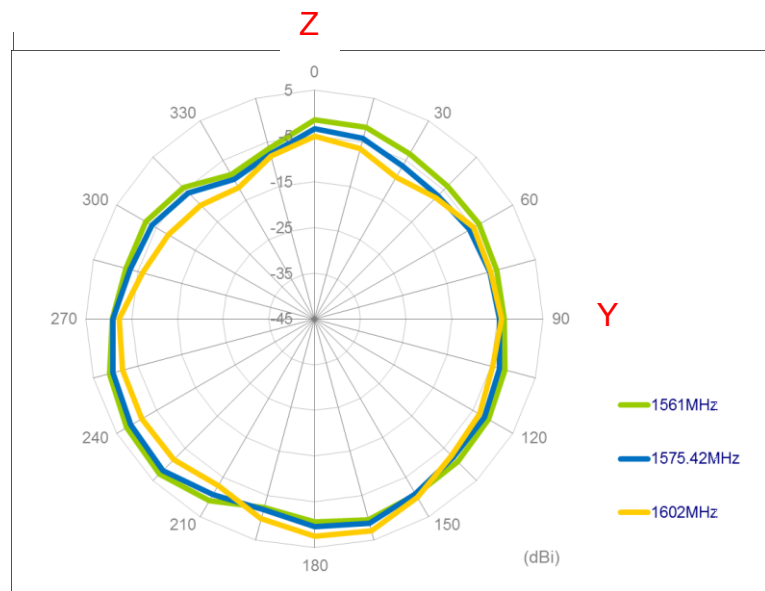
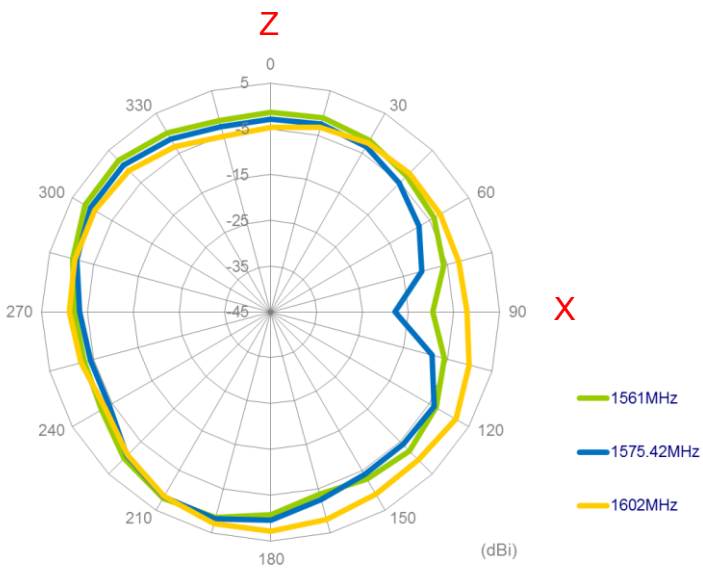
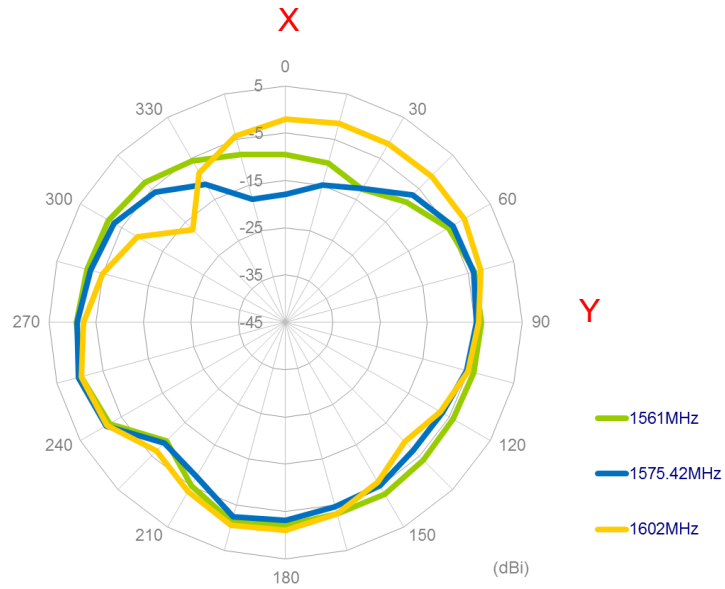

3.1.9. 3D Radiation Pattern (Passive antenna)

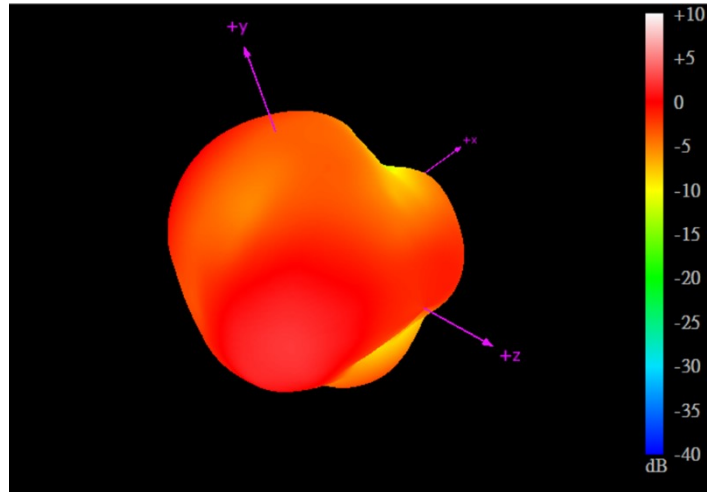

1561MHz

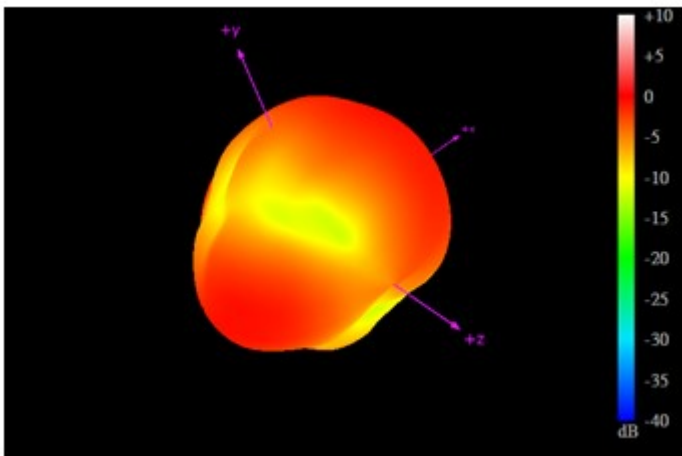

1575.42MHz

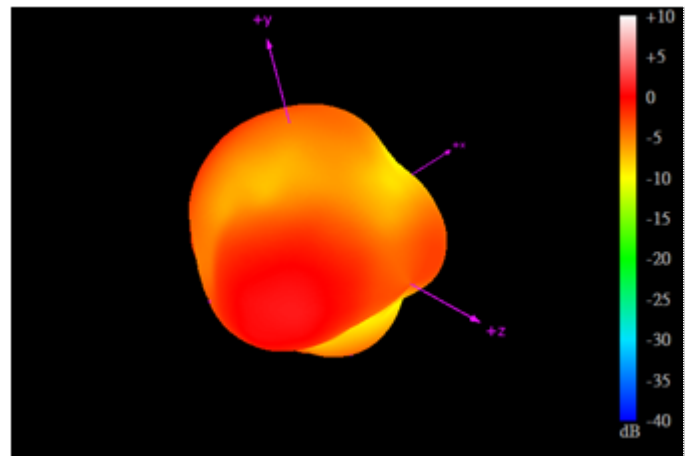

1602MHz

3.1.10. Axial Ratio (Passive antenna)

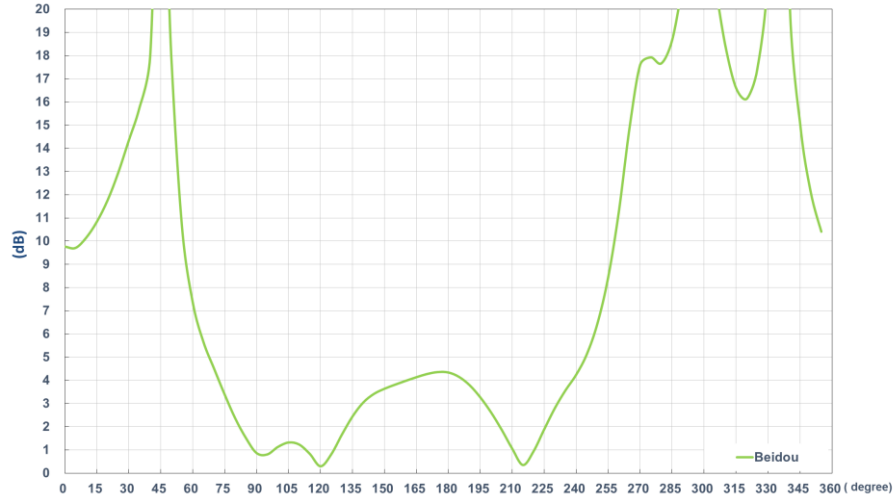

1561MHz

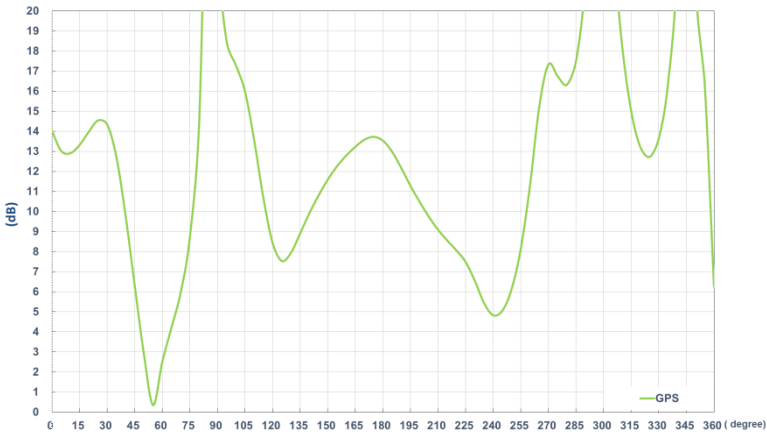

1575.42MHz

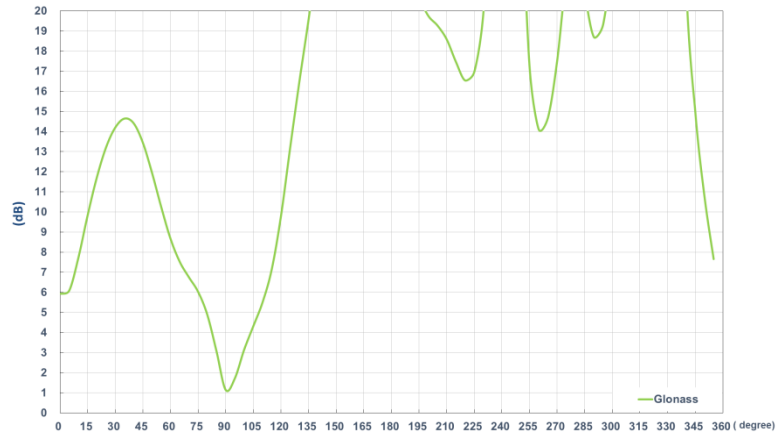

1602MHz

3.1.11. GPS-GLONASS-GALILEO-BeiDou LNA Gain and Noise Figure (Active antenna)

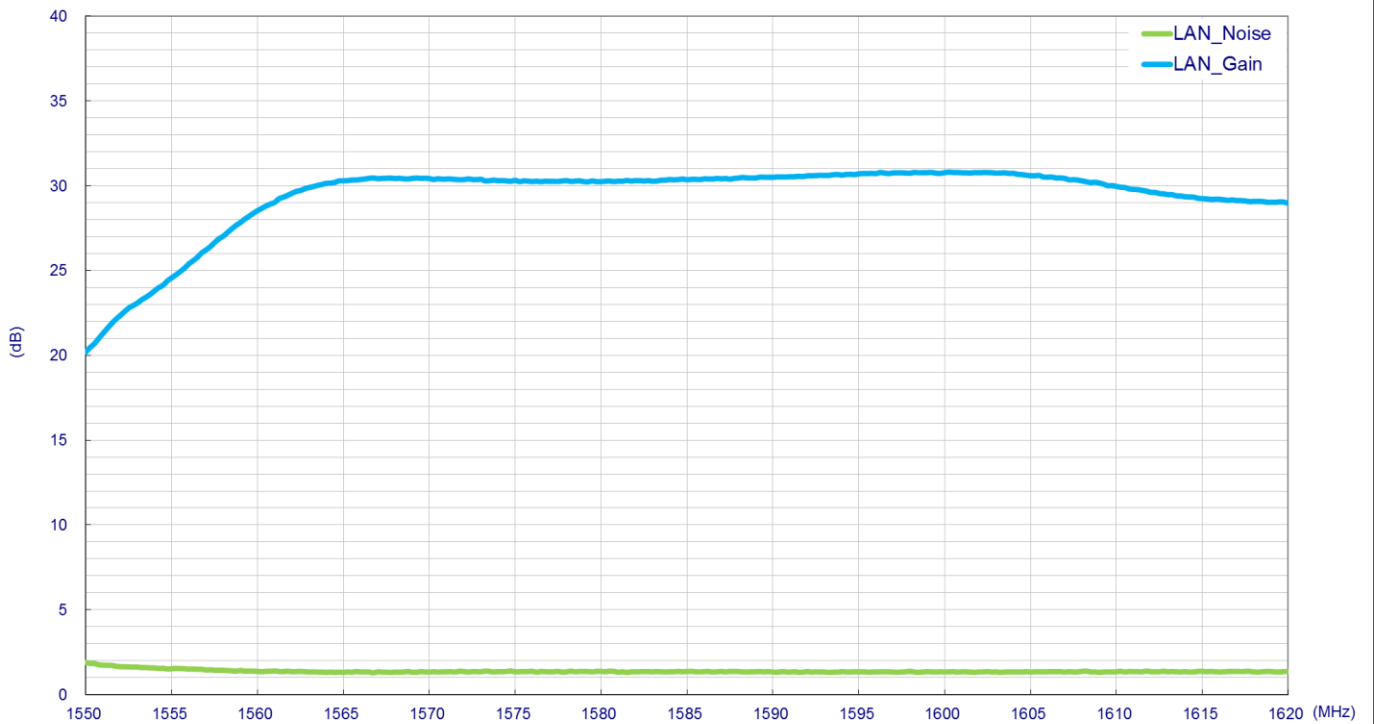
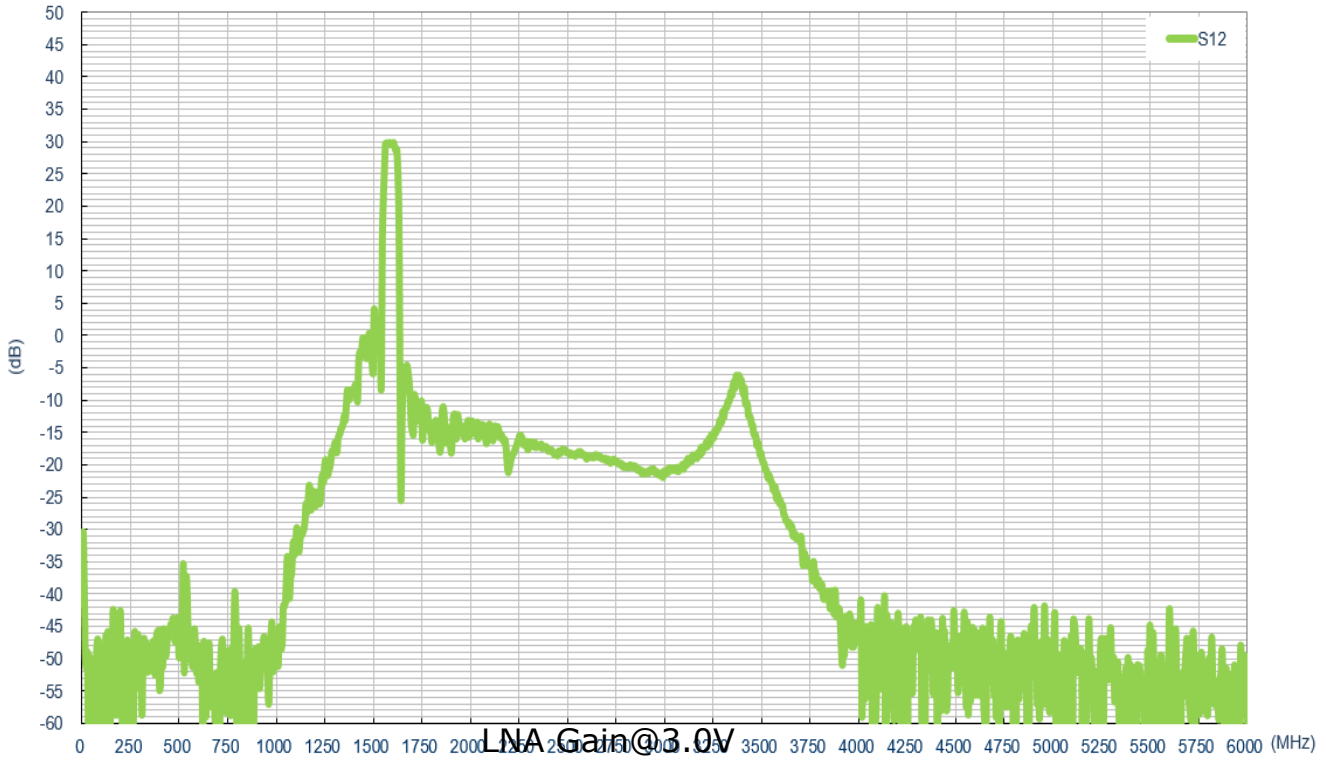

LNA Noise Figure @3.0V

3.2. LTE_MIMO/Wi-Fi_MIMO Antenna

3.2.1. Test Setup

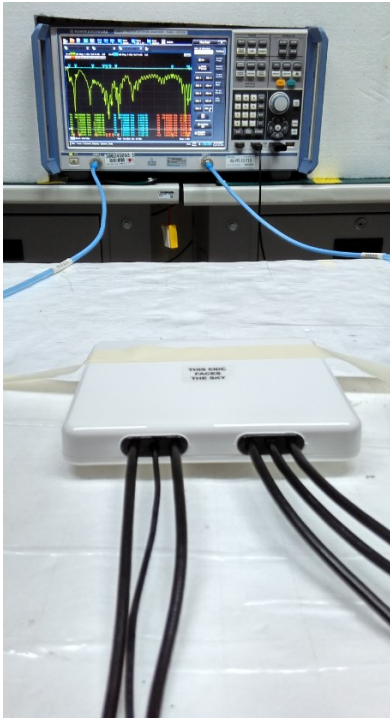

Free space



ABS

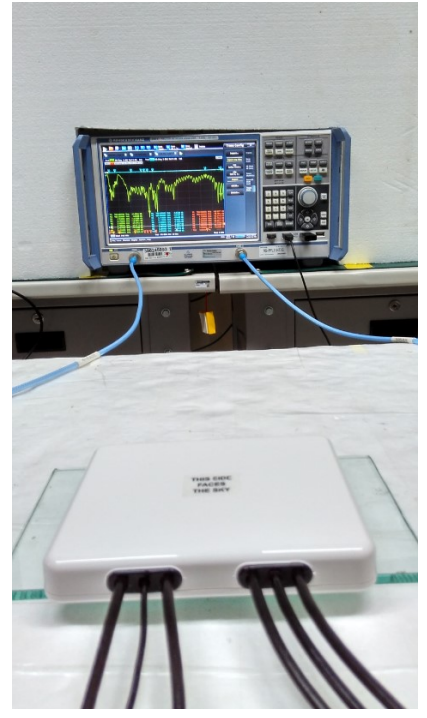

Glass

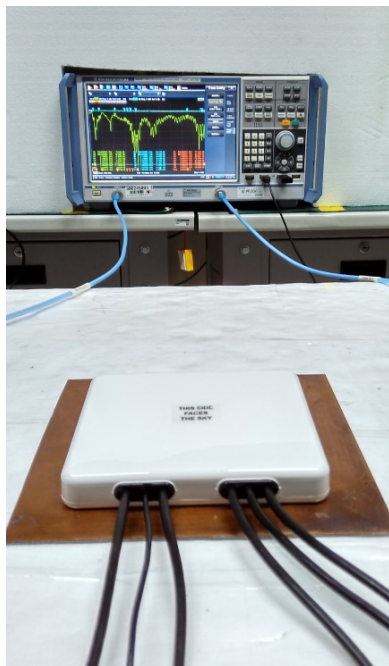

Metal

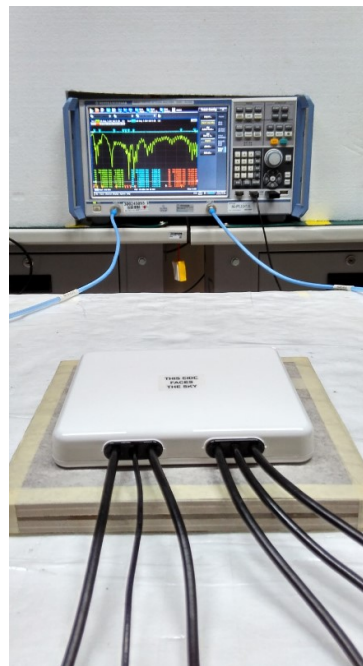

Wall

3.2.2. LTE_1 Antenna Return Loss

Performance in different environments with 1 meter cable length

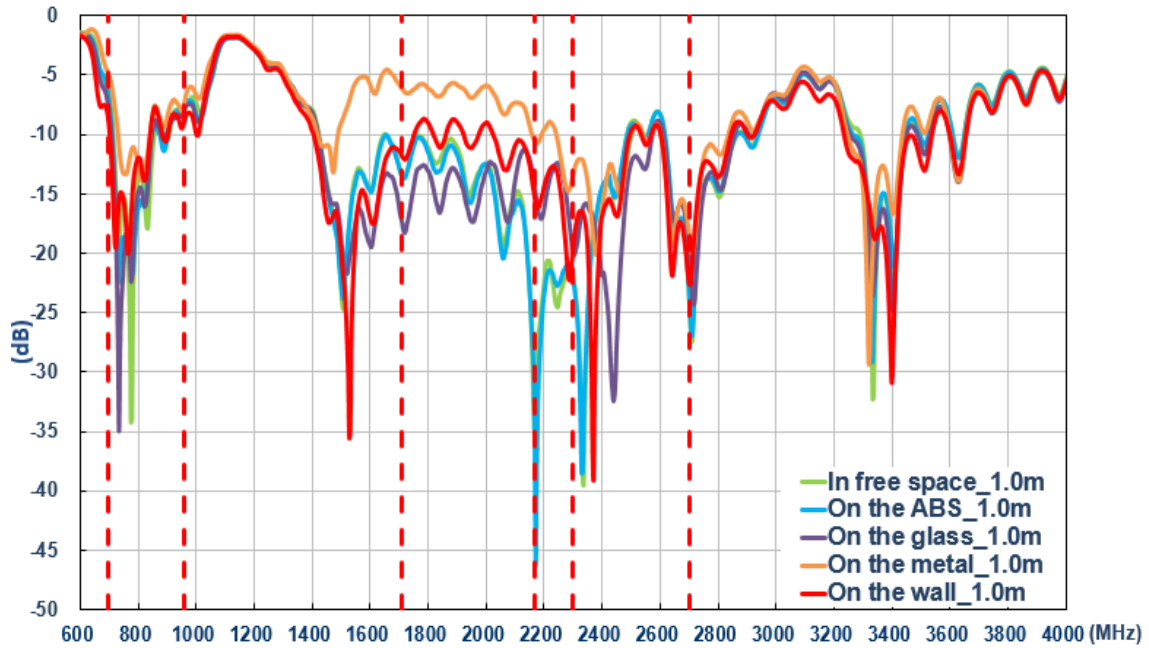

3.2.3. LTE_2 Antenna Return Loss

Performance in different environments with 1 meter cable length

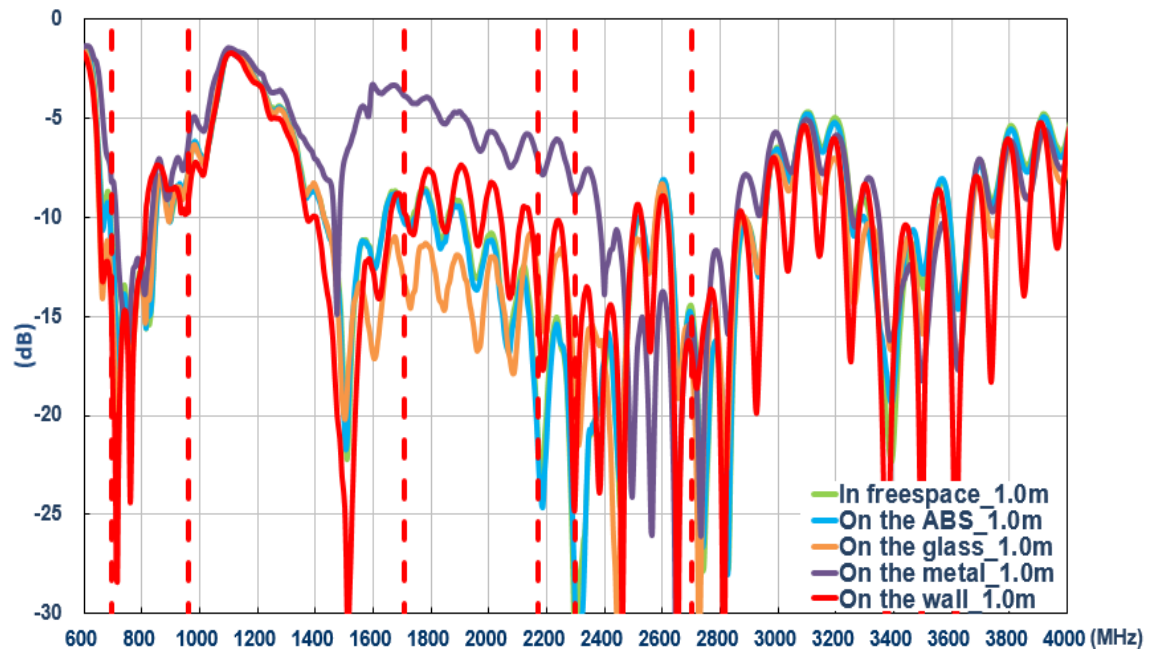

3.2.4. LTE Envelope Correlation Coefficient

Performance in different environments with 1 meter cable length

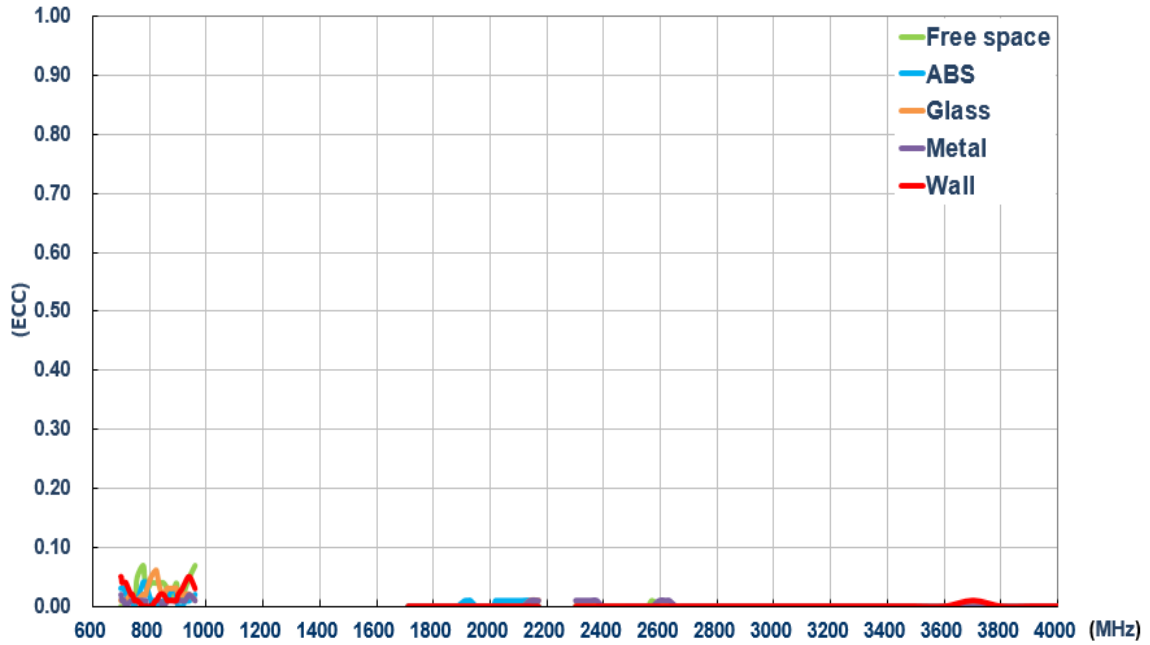

3.2.5. LTE_1 Antenna Efficiency

Performance in different environments with 1 meter cable length

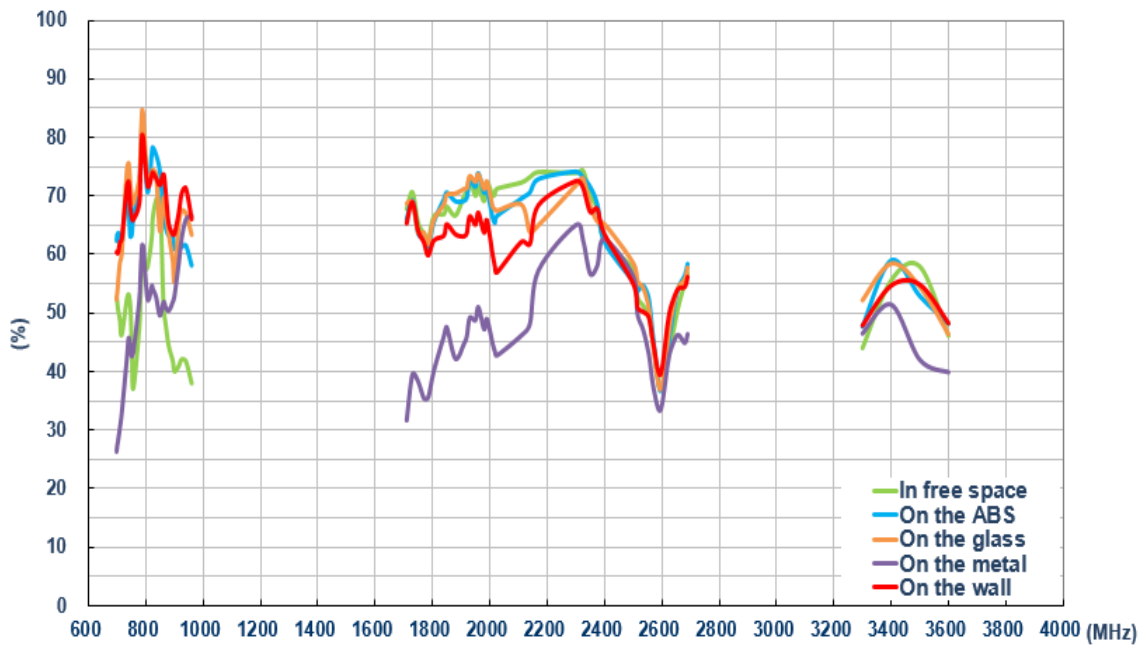

3.2.6. LTE_2 Antenna Efficiency

Performance in different environments with 1 meter cable length

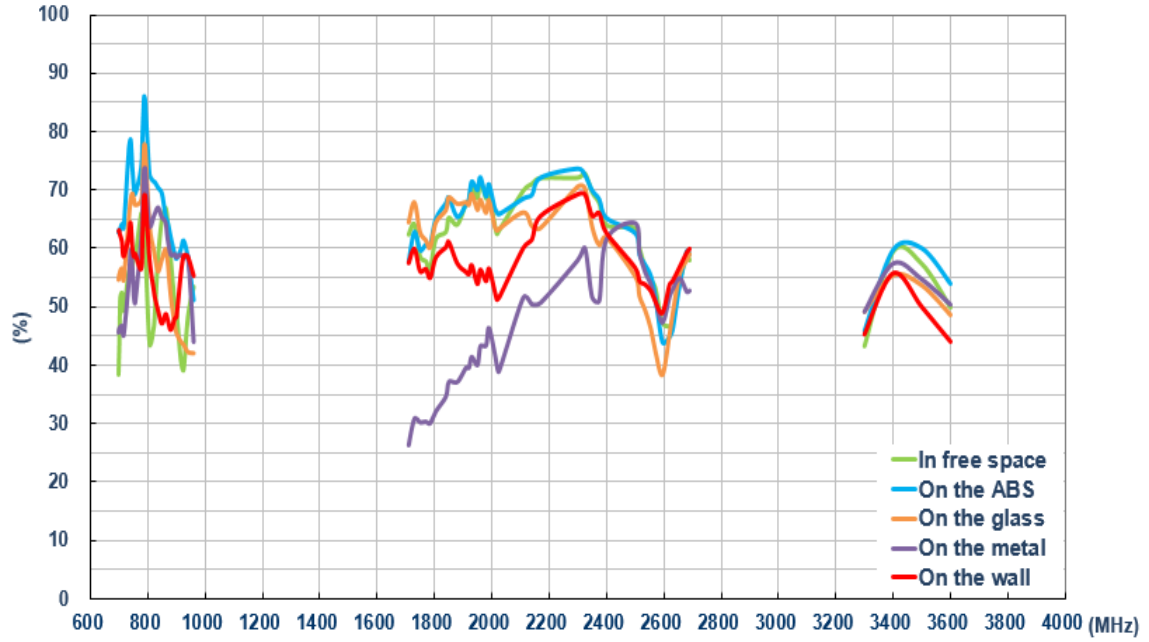

3.2.7. LTE_1 Antenna Average Gain

Performance in different environments with 1 meter cable length

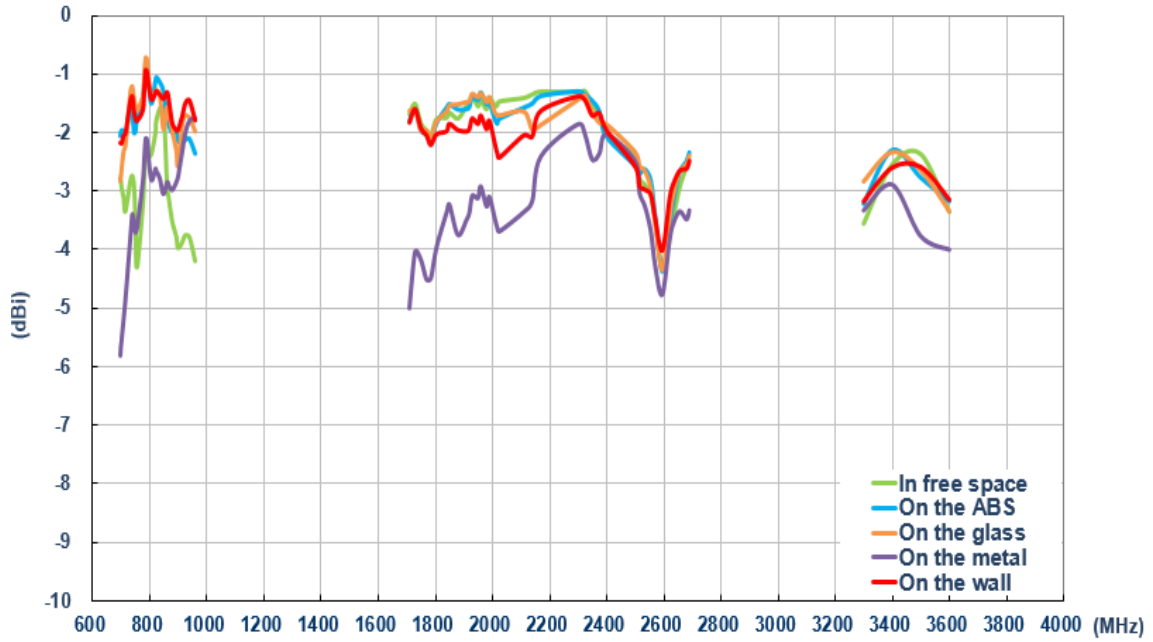

3.2.8. LTE_2 Antenna Average Gain

Performance in different environments with 1 meter cable length

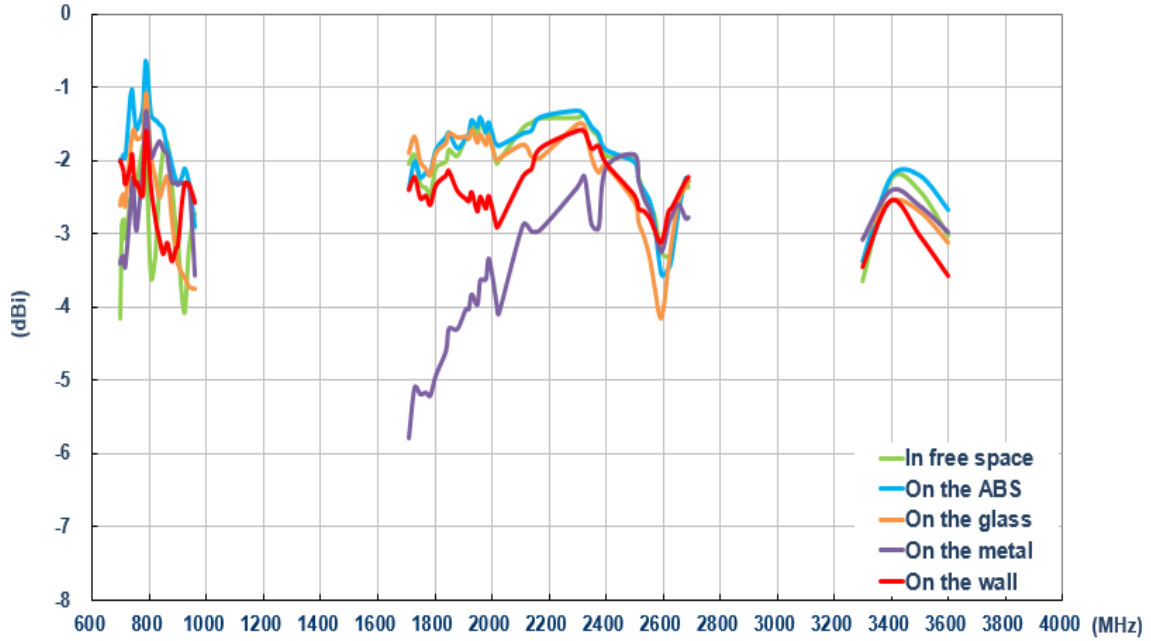

3.2.9. LTE_1 Antenna Peak Gain

Performance in different environments with 1 meter cable length

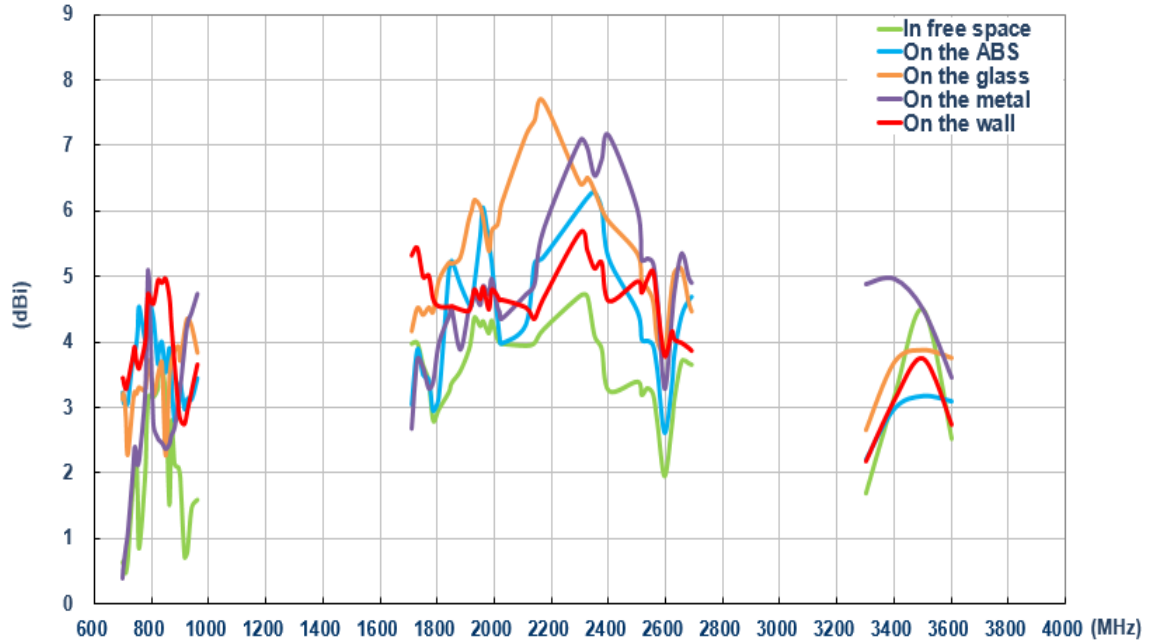

3.2.10. LTE_2 Antenna Peak Gain

Performance in different environments with 1 meter cable length

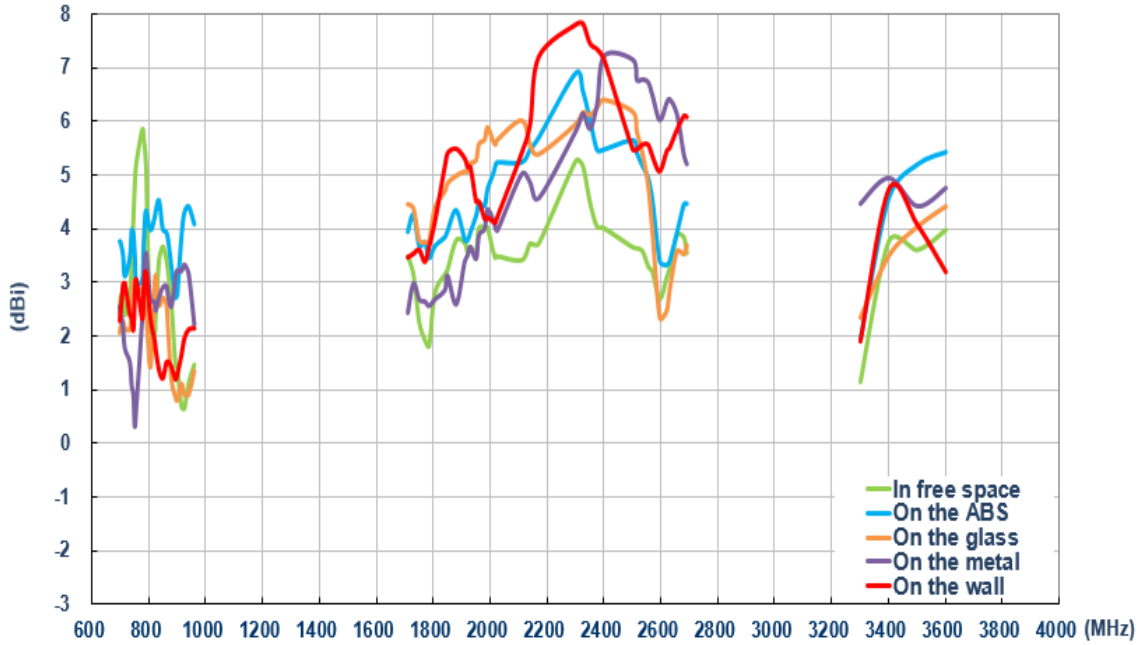

3.2.11. Wi-Fi_1 Antenna Return Loss

Performance in different environments with 1 meter cable length

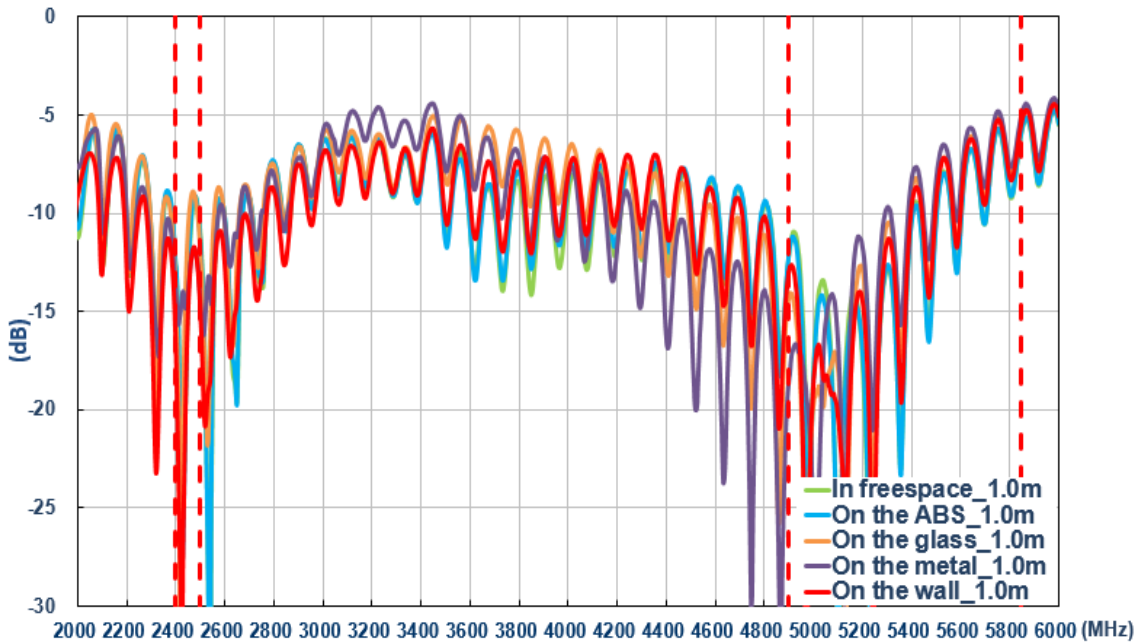

3.2.12. Wi-Fi_2 Antenna Return Loss

Performance in different environments with 1 meter cable length

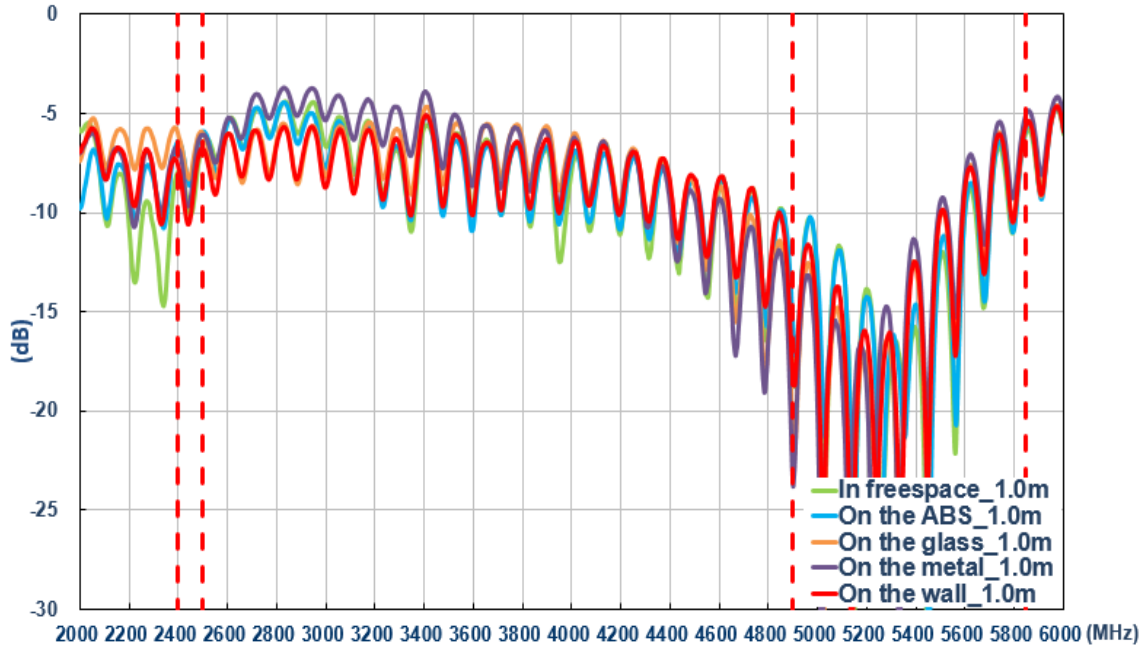

3.2.13. Wi-Fi Envelope Correlation Coefficient

Performance in different environments with 1 meter cable length

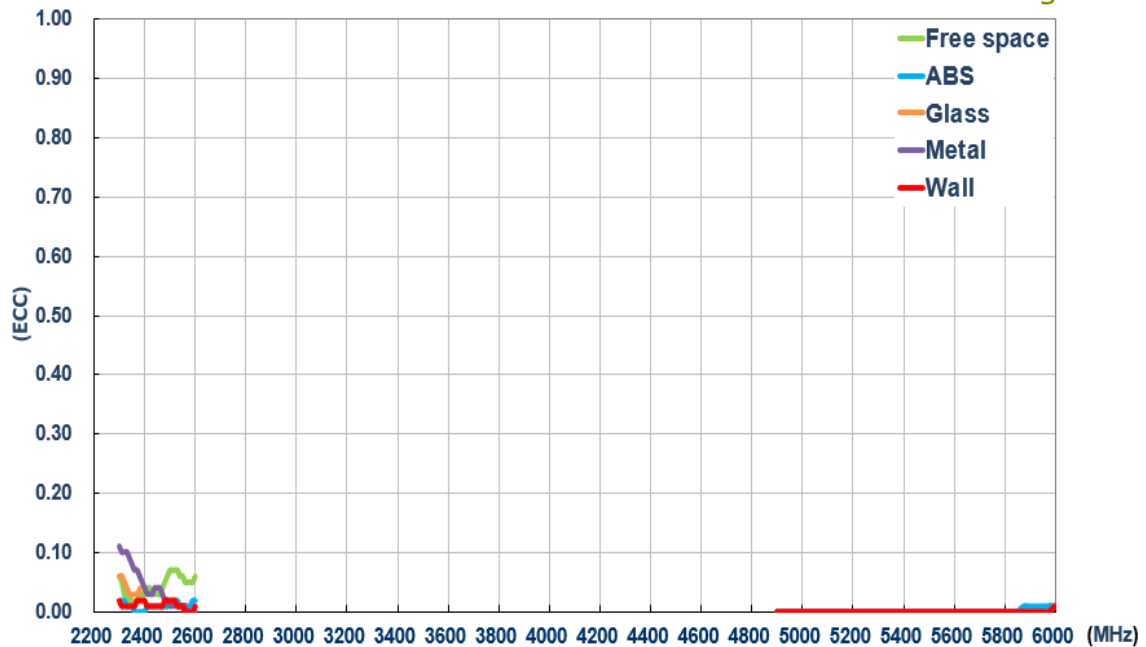

3.2.14. Wi-Fi_1 Antenna Efficiency

Performance in different environments with 1 meter cable length

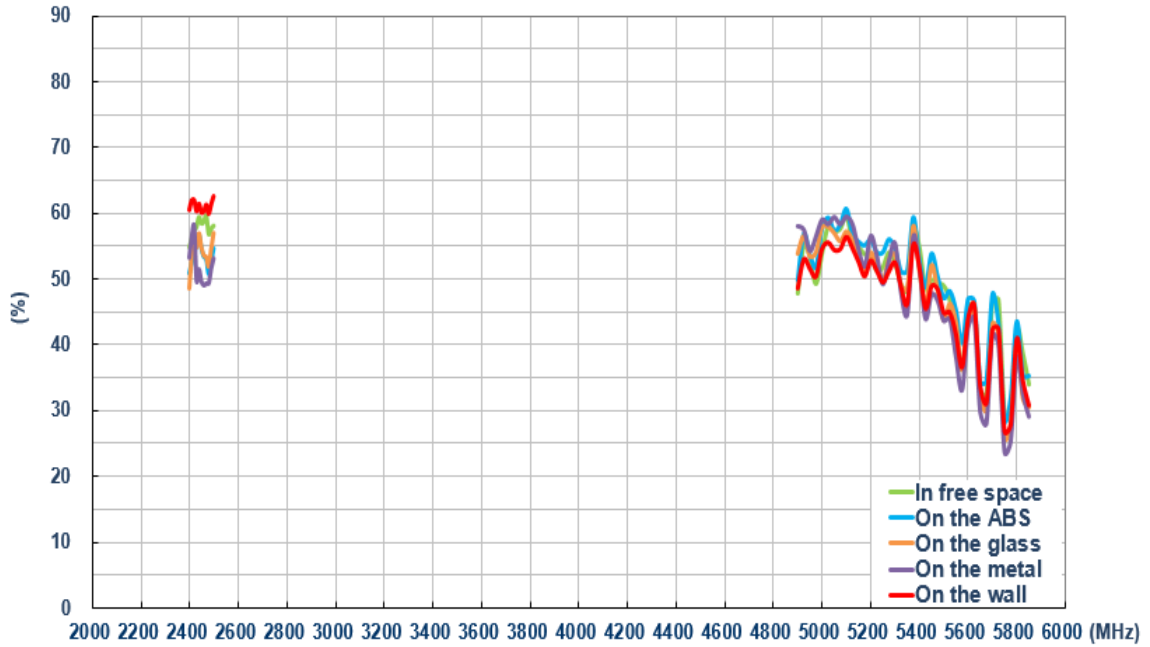

3.2.15. Wi-Fi_2 Antenna Efficiency

Performance in different environments with 1 meter cable length

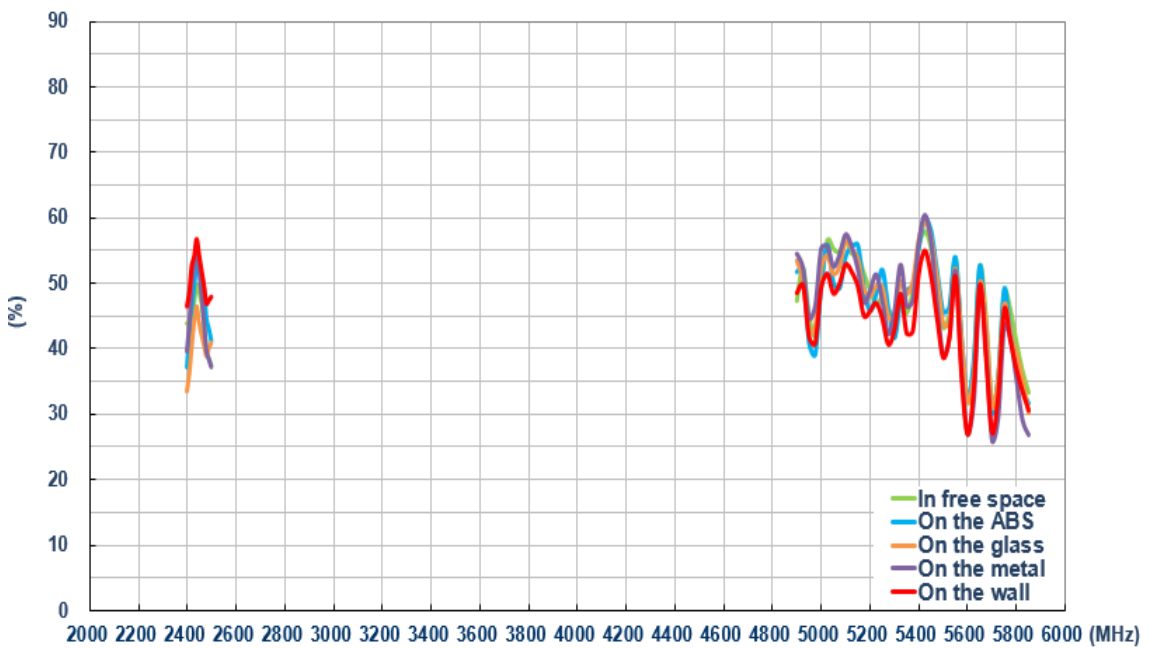

3.2.16. Wi-Fi_1 Antenna Average Gain

Performance in different environments with 1 meter cable length

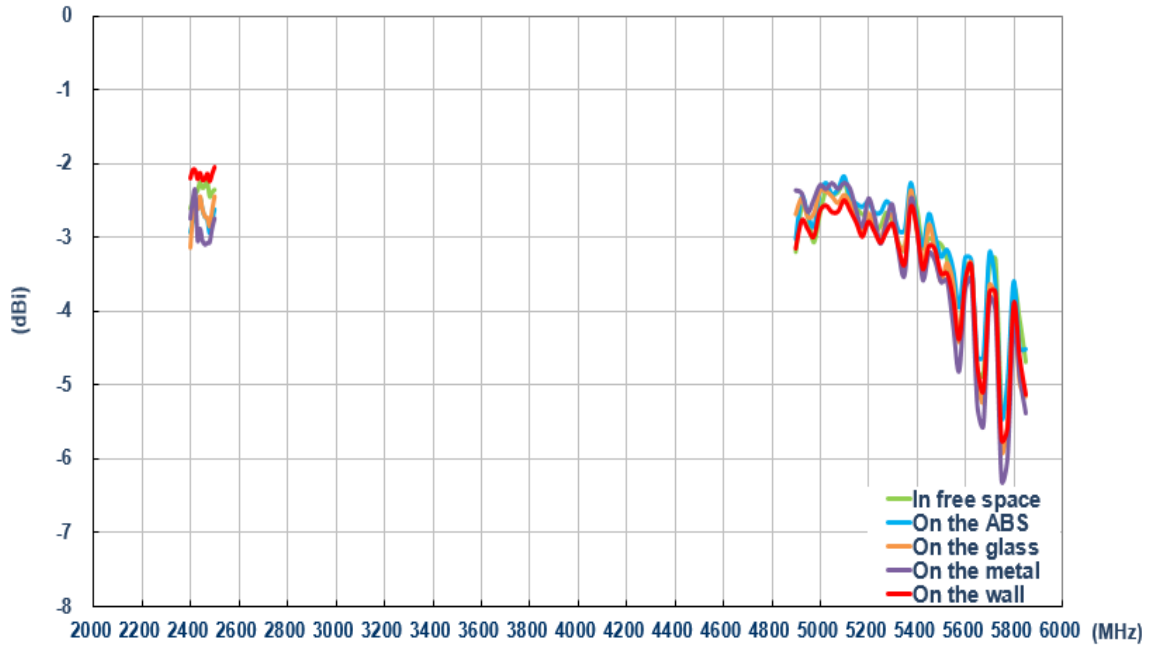

3.2.17. Wi-Fi_2 Antenna Average Gain

Performance in different environments with 1 meter cable length

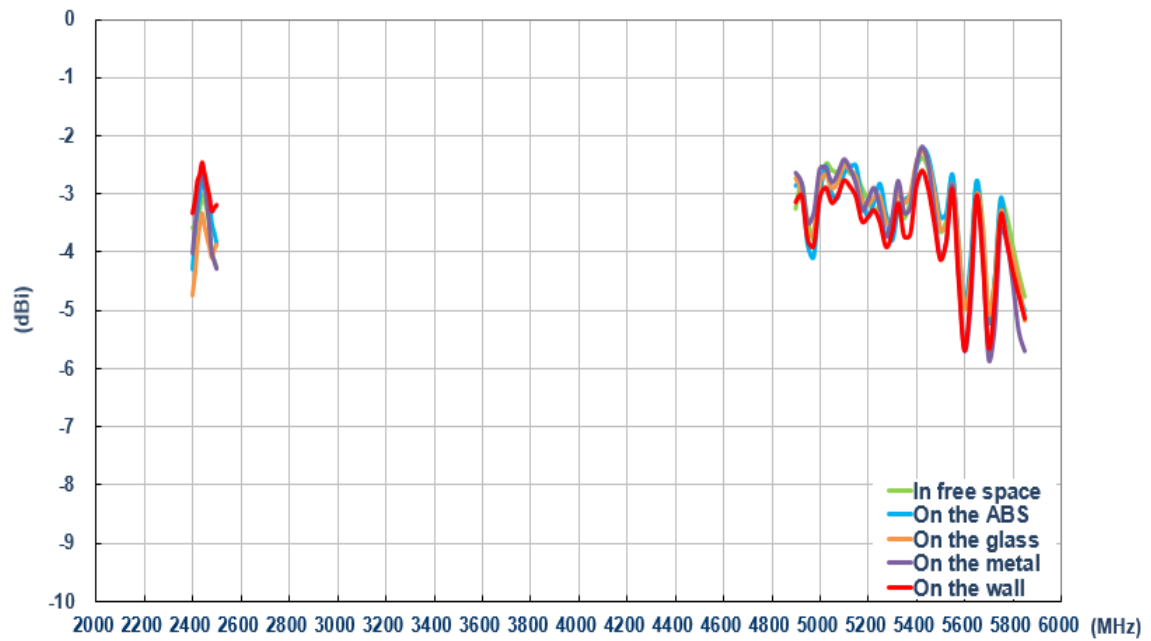

3.2.18. Wi-Fi_1 Antenna Peak Gain

Performance in different environments with 1 meter cable length

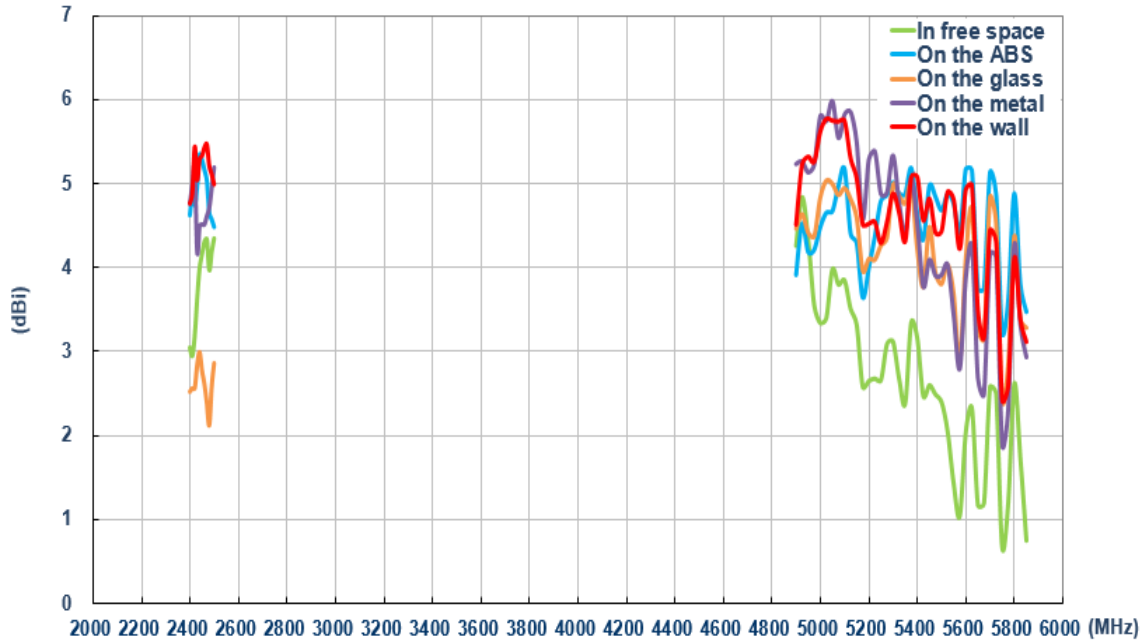

3.2.19. Wi-Fi_2 Antenna Peak Gain

Performance in different environments with 1 meter cable length

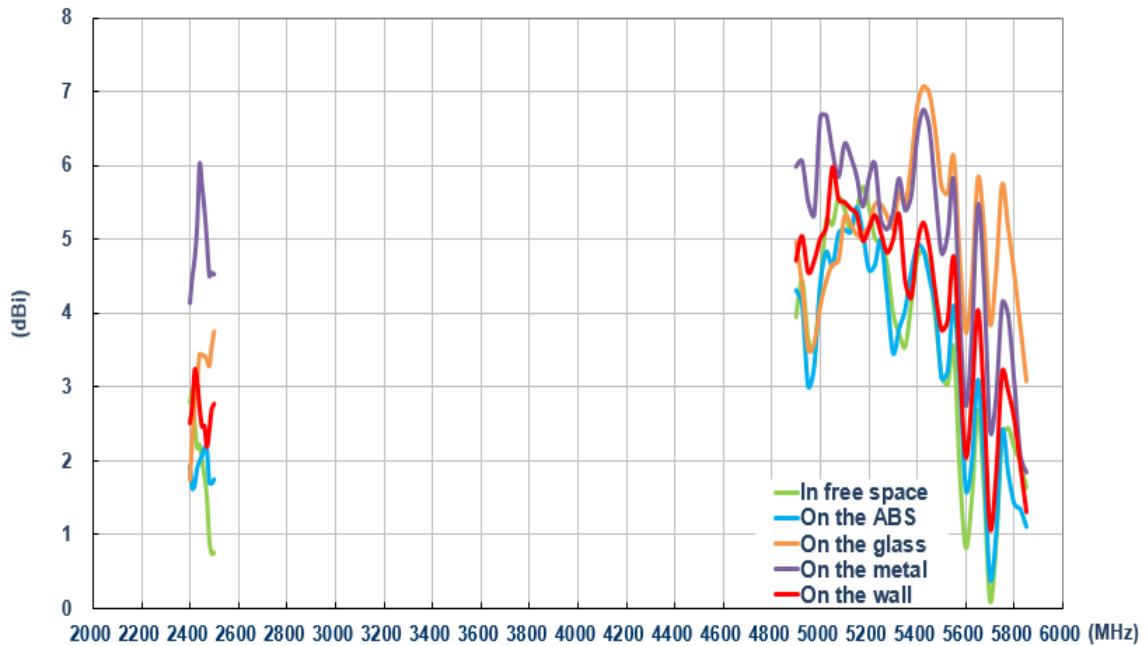

3.2.20. Test Setup for Antenna Radiation Pattern

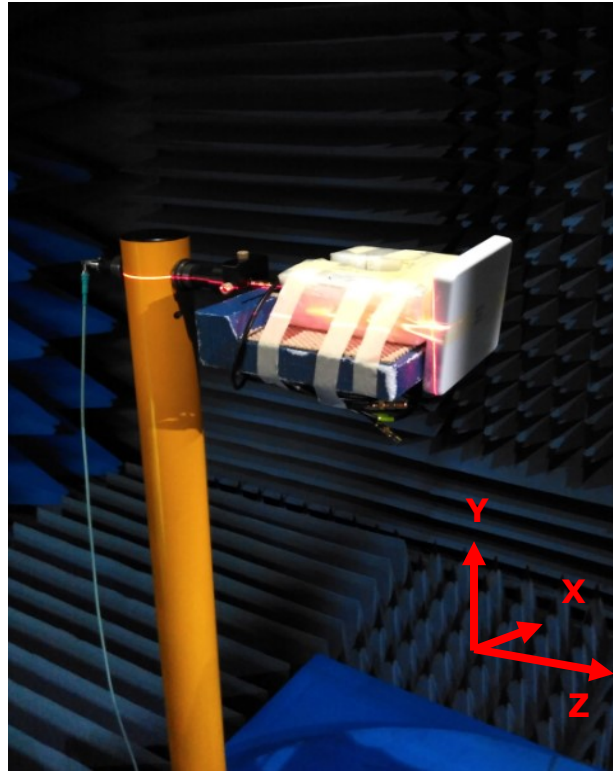

In free space

3.2.20 2D Radiation Pattern (LTE_MIMO1 with 1M cable length in free space)

XY Plane

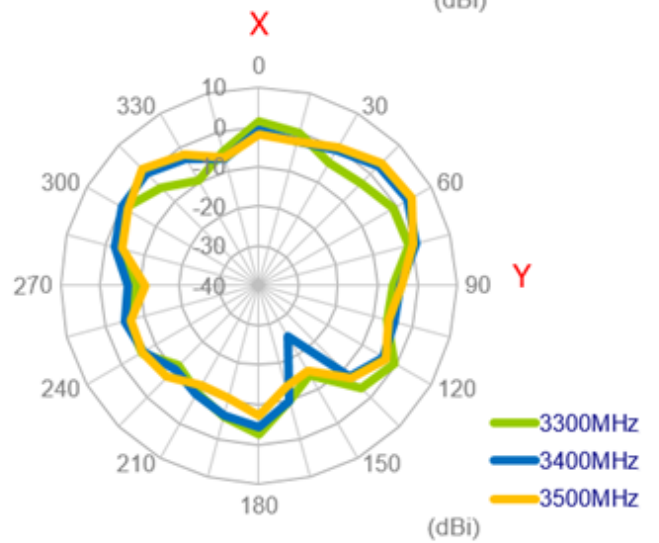
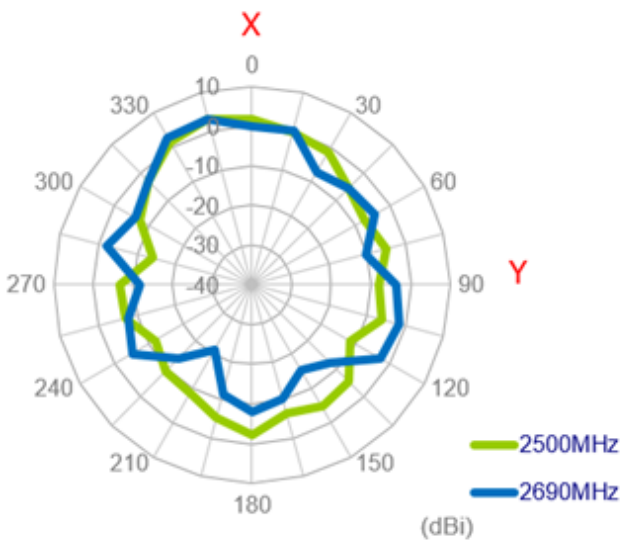
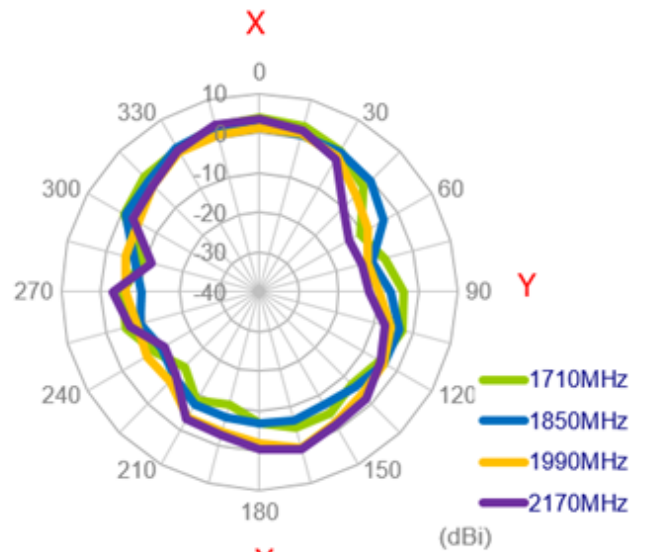
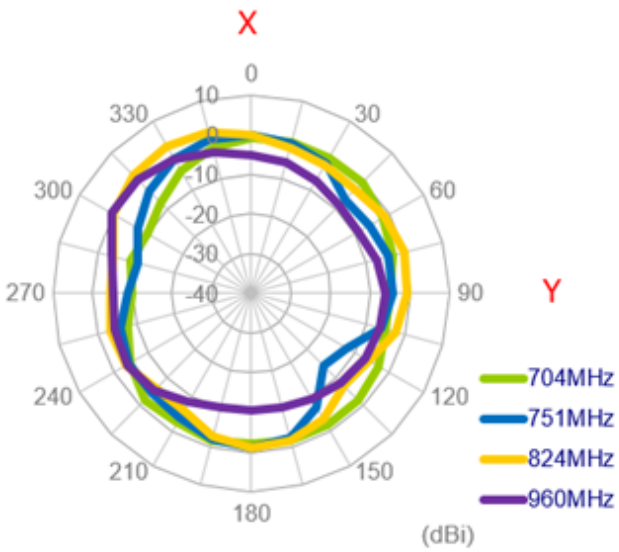

XZ Plane

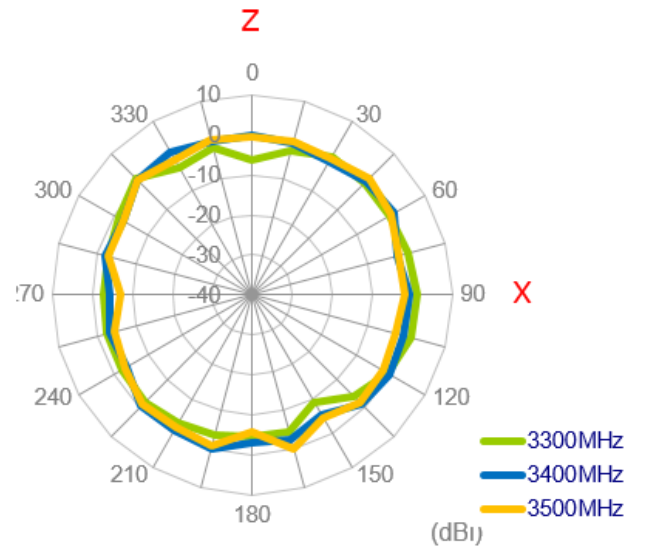
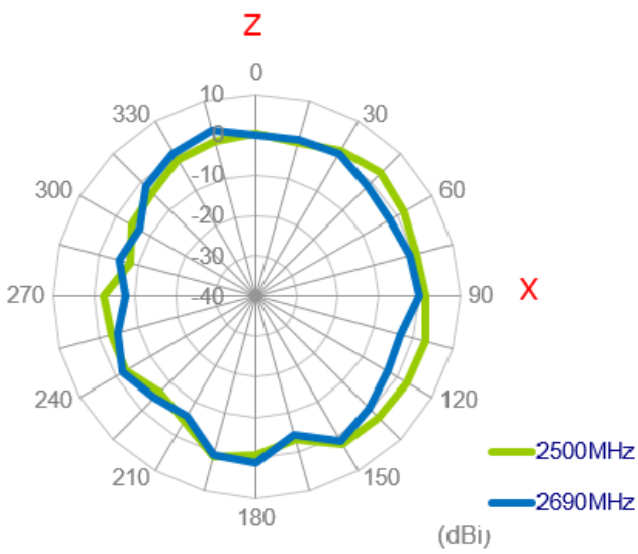
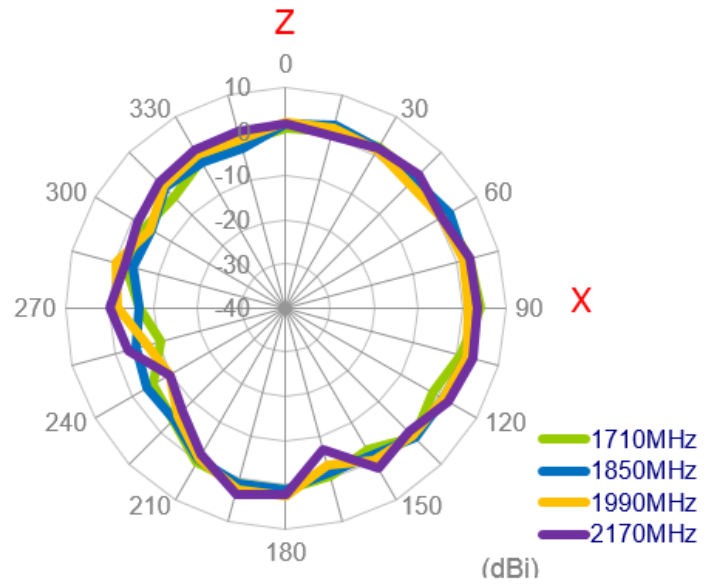
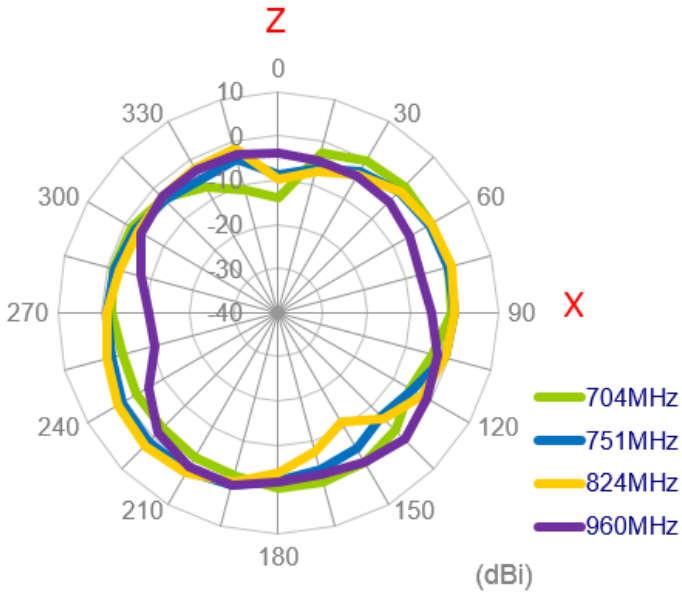

YZ Plane

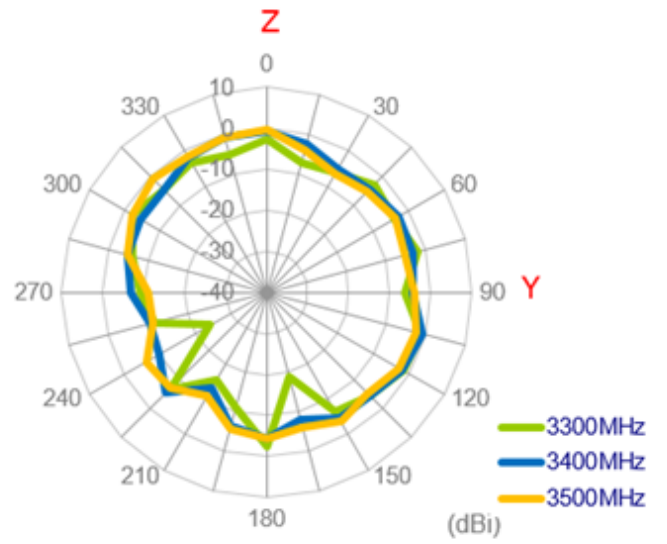
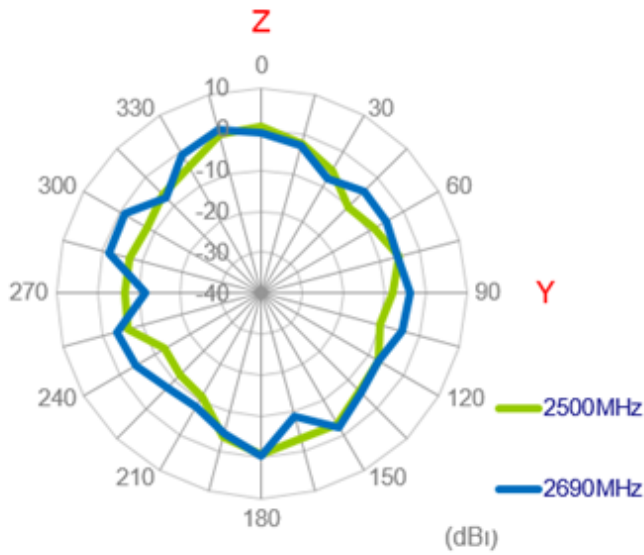
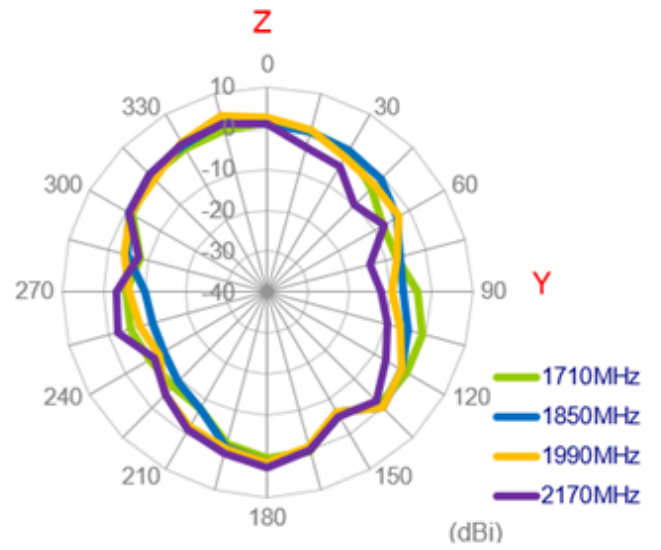
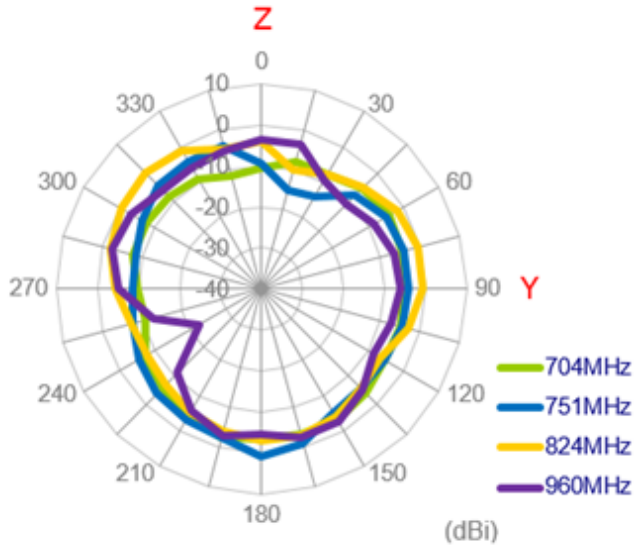

3.2.21. 3D Radiation Pattern (LTE_MIMO1 with 1M cable length in free space)

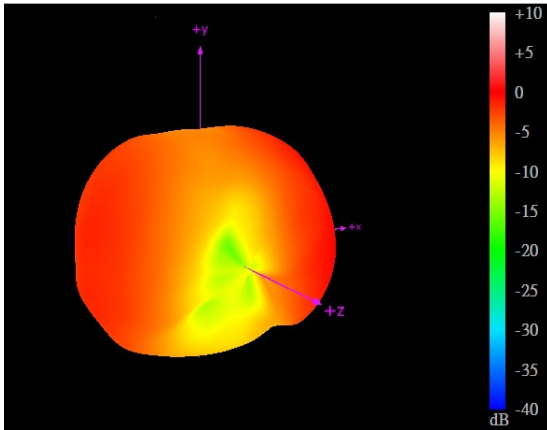

704MHz

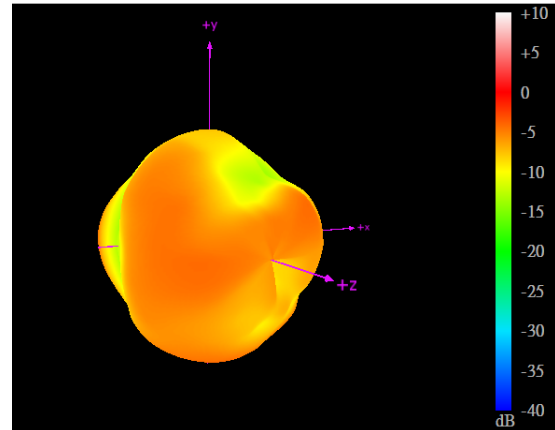

960MHz

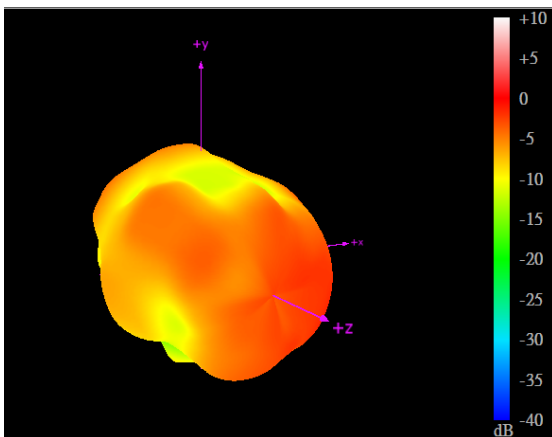

1710MHz

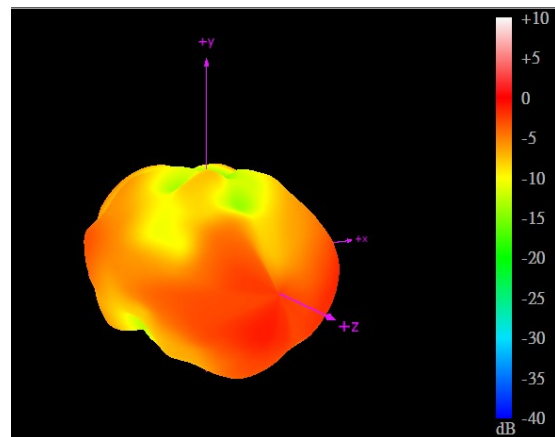

2170MHz

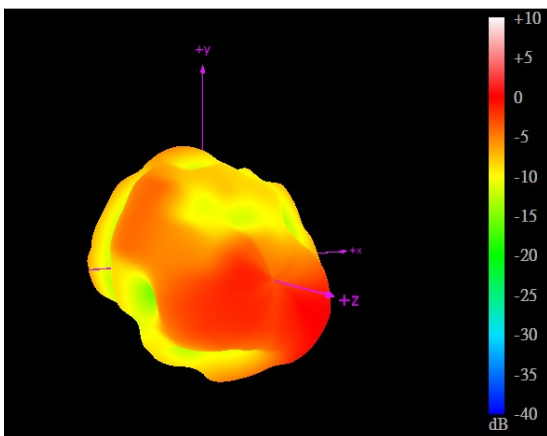

2690MHz

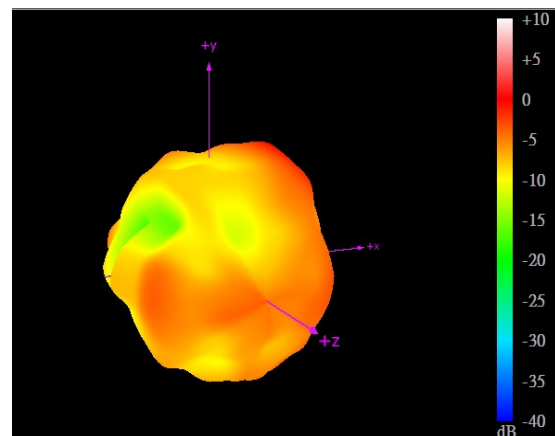

3500MHz

3.2.22. 2D Radiation Pattern (LTE_MIMO2 with 1M cable length in free space)

XY Plane

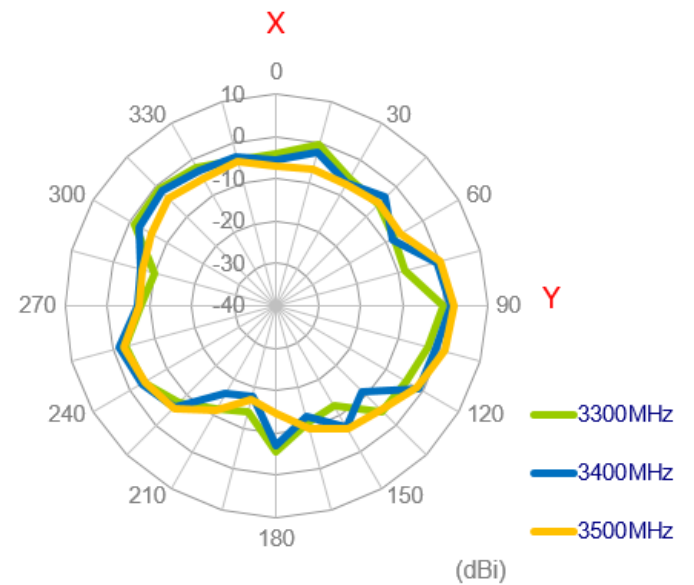
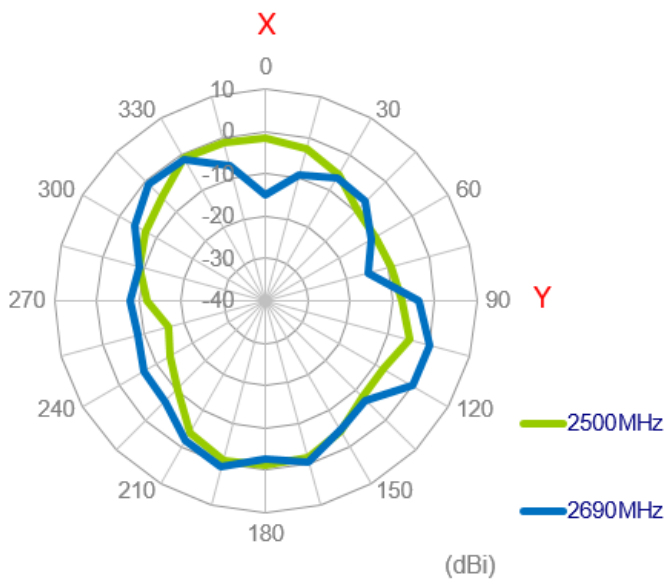
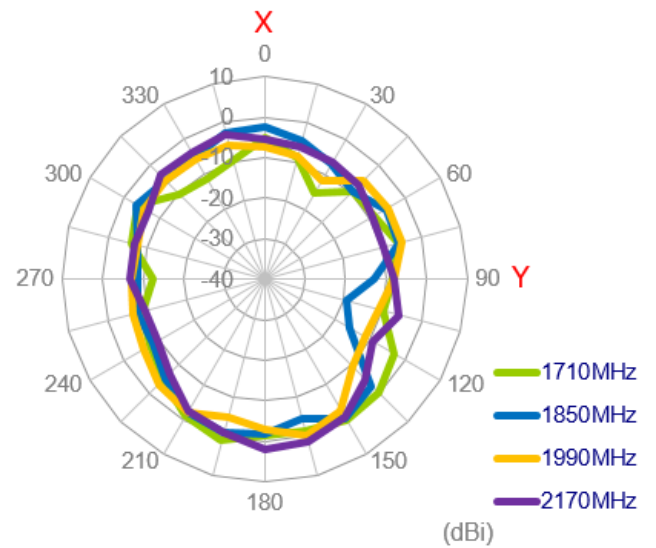
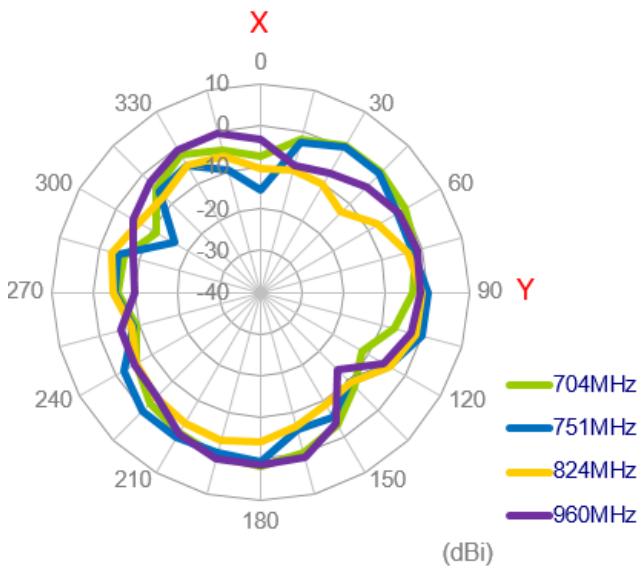

XZ Plane

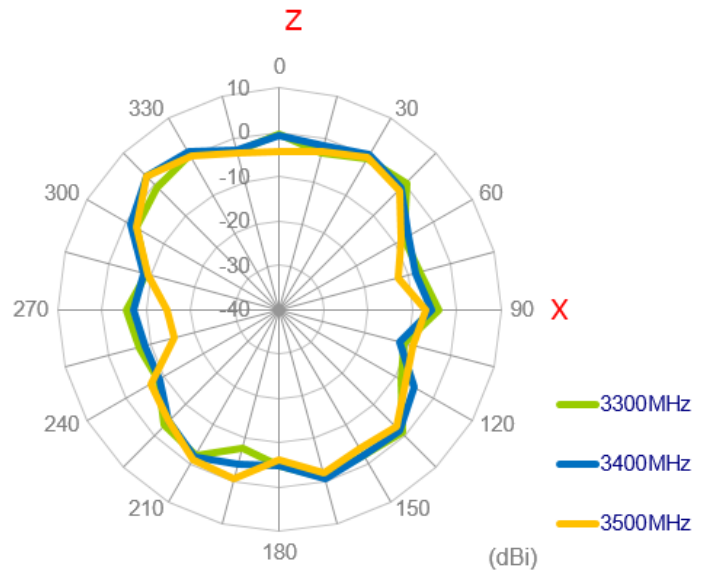
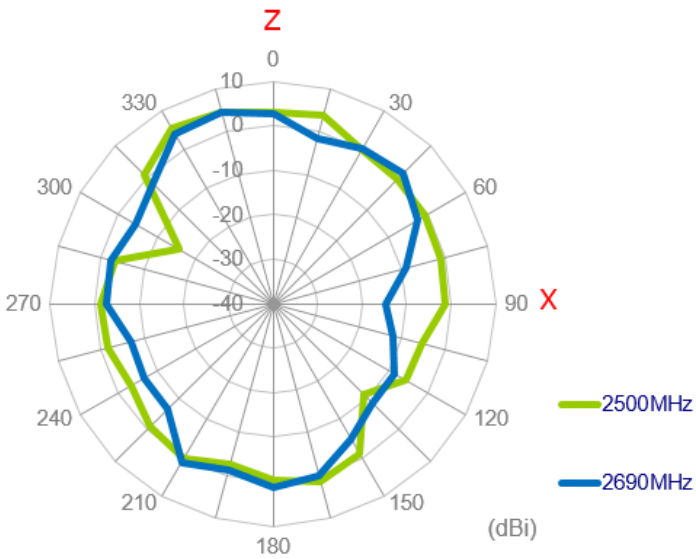
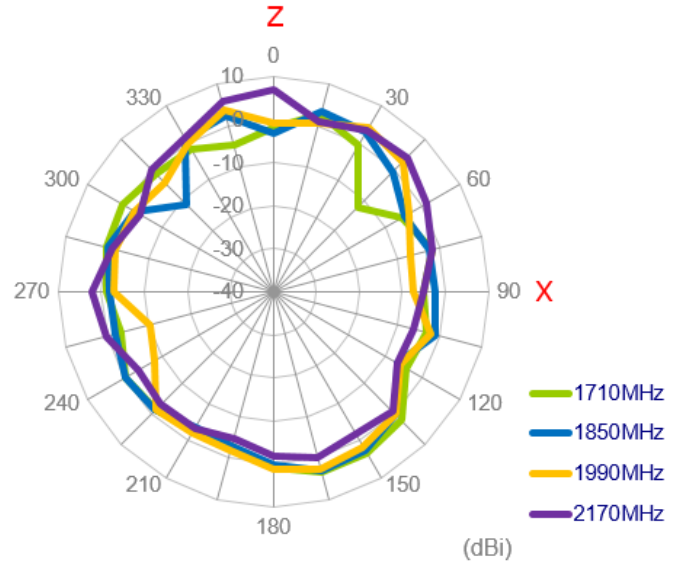
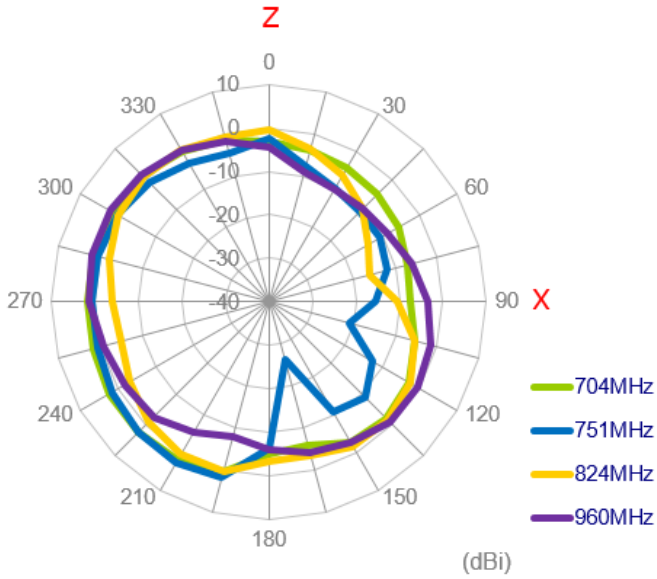

YZ Plane

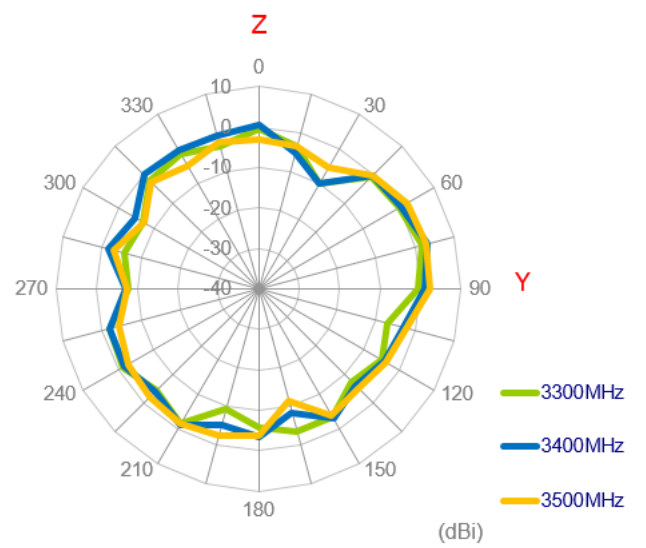
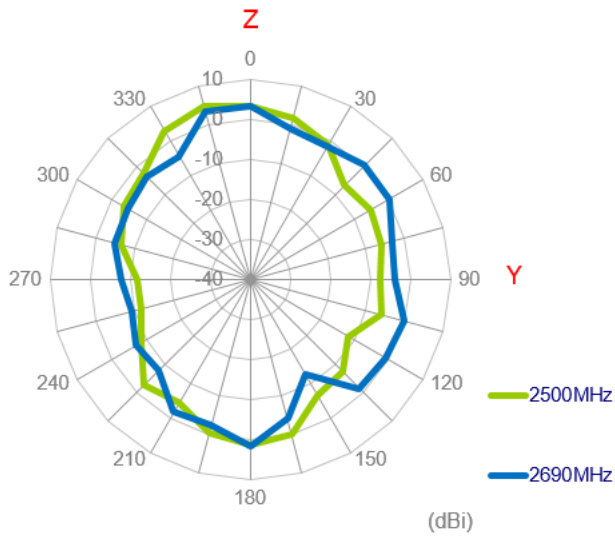
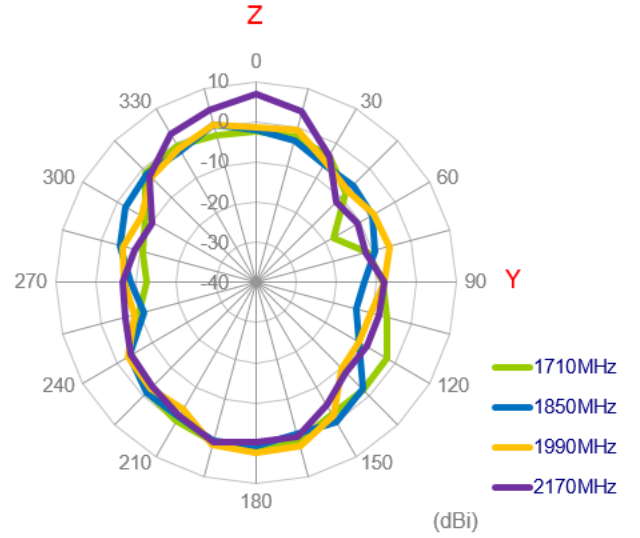
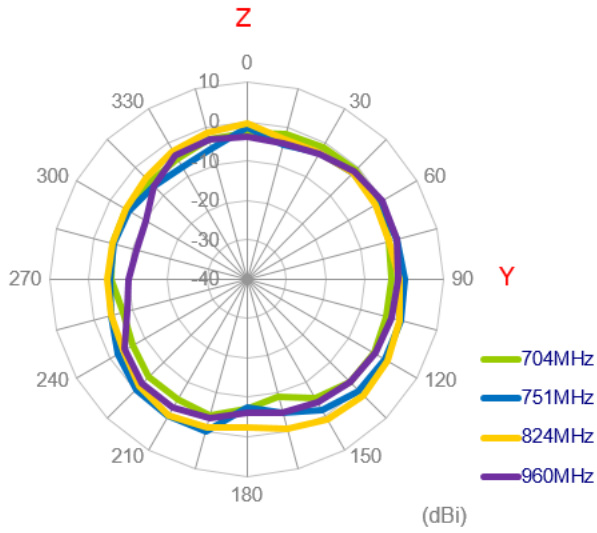

3.2.23. 3D Radiation Pattern (LTE_MIMO2 with 1M cable length in free space)

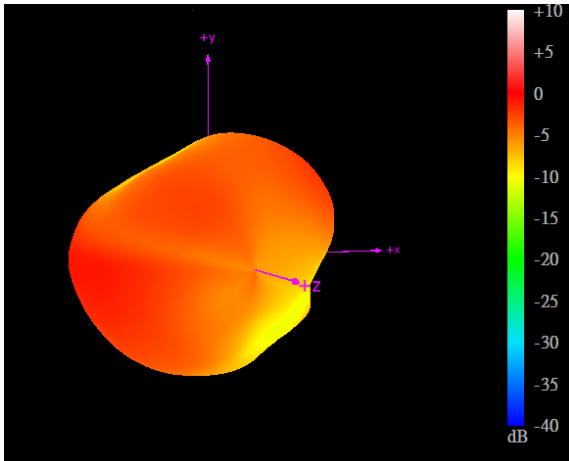

704MHz

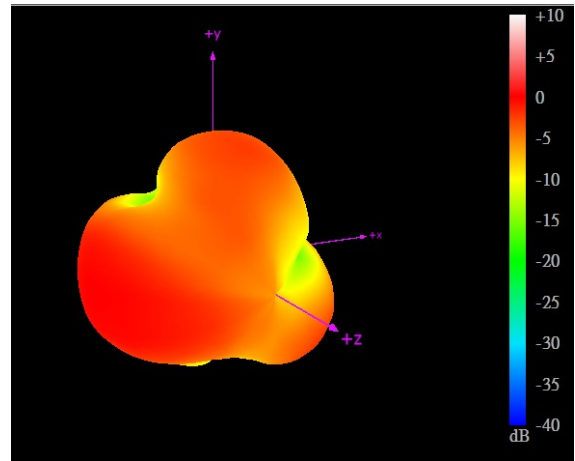

960MHz

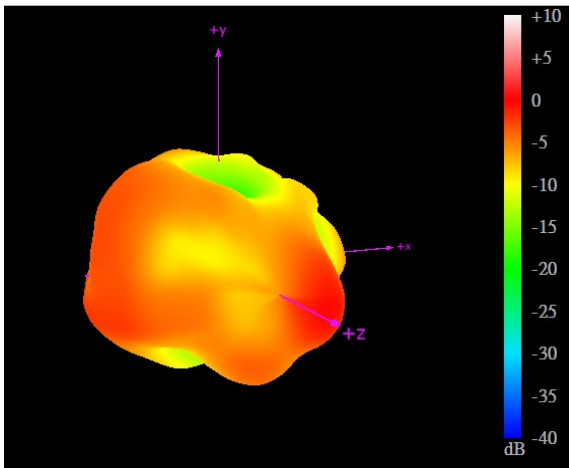

1710MHz

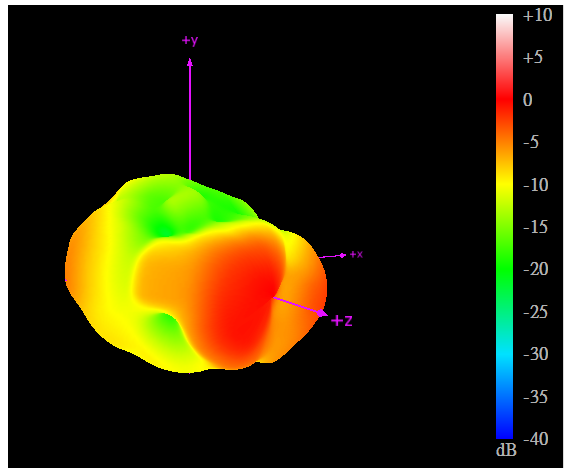

2170MHz

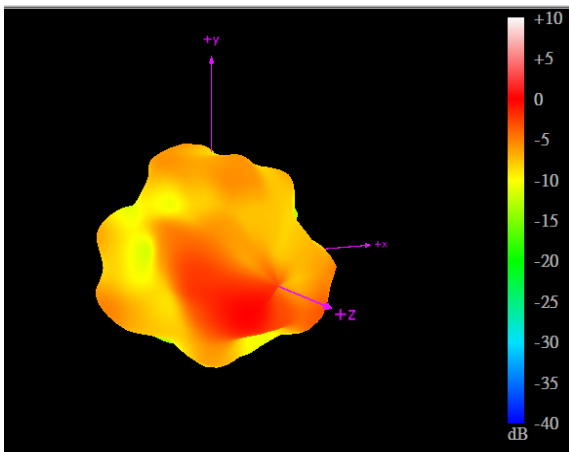

2690MHz

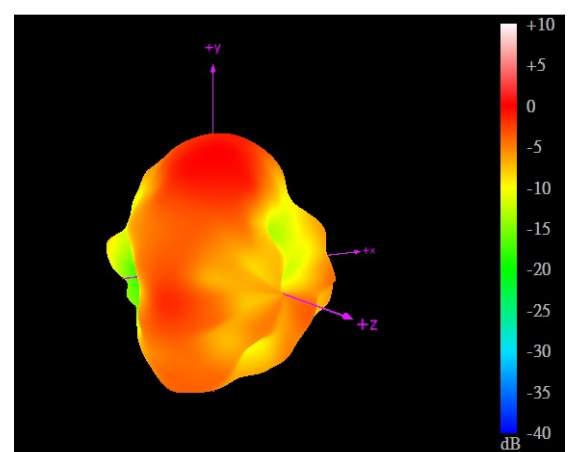

3500MHz

3.2.24. 2D Radiation Pattern (Wi-Fi_MIMO1 with 1M cable length in free space)

XY Plane

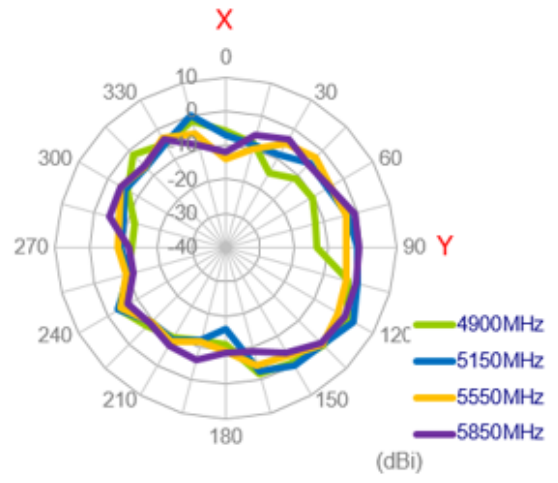
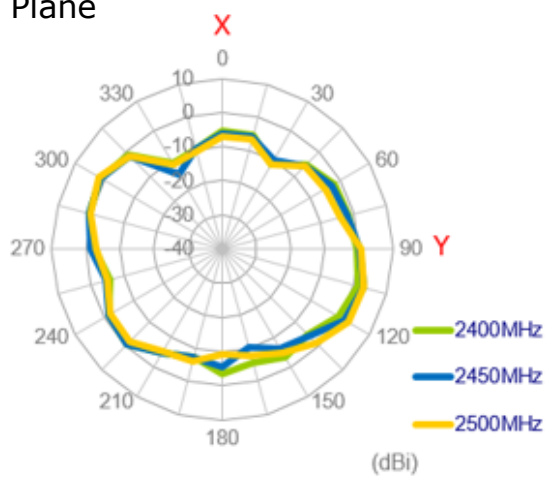

XZ Plane

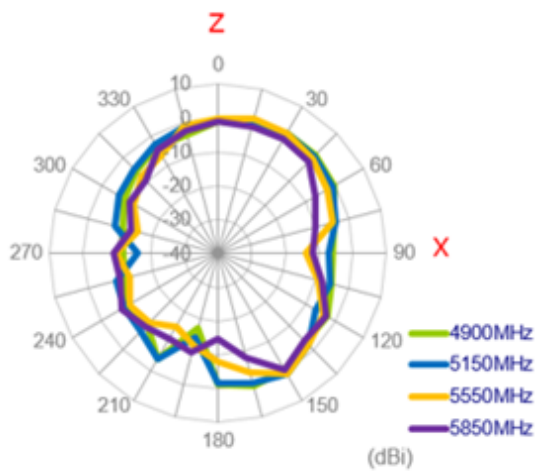
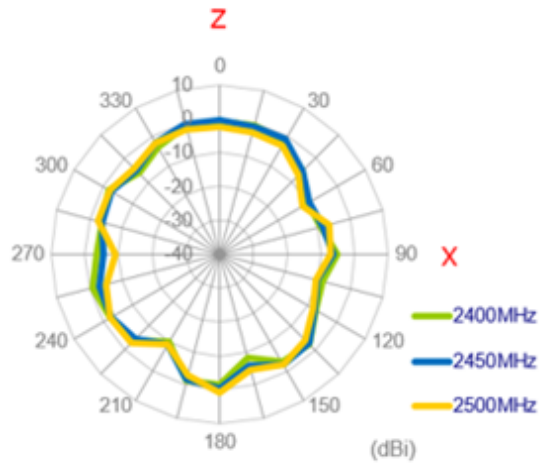

YZ Plane

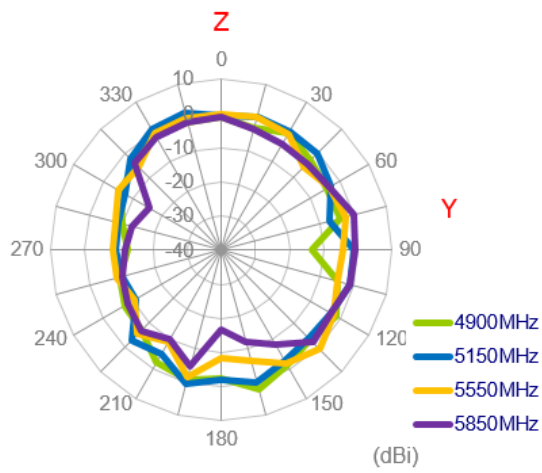
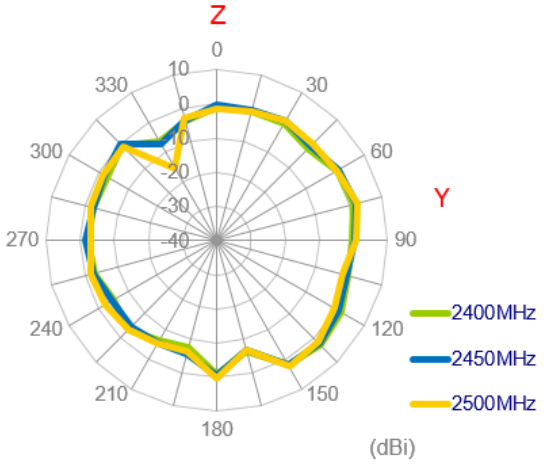

3.2.25. 3D Radiation Pattern (Wi-Fi_MIMO1 with 1M cable length in free space)

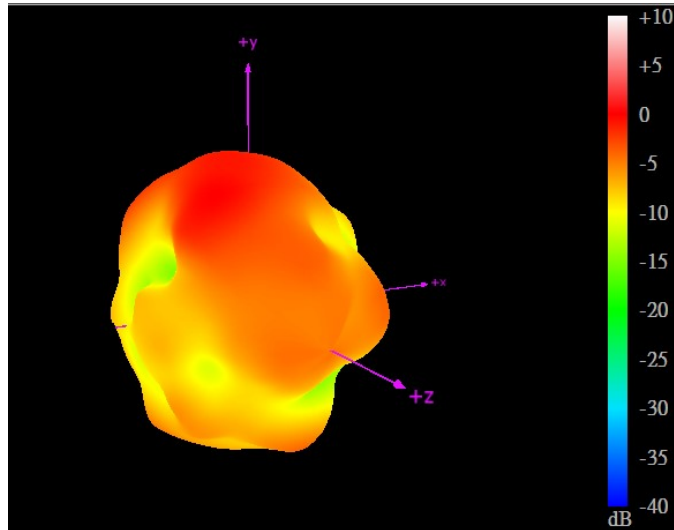

2450MHz

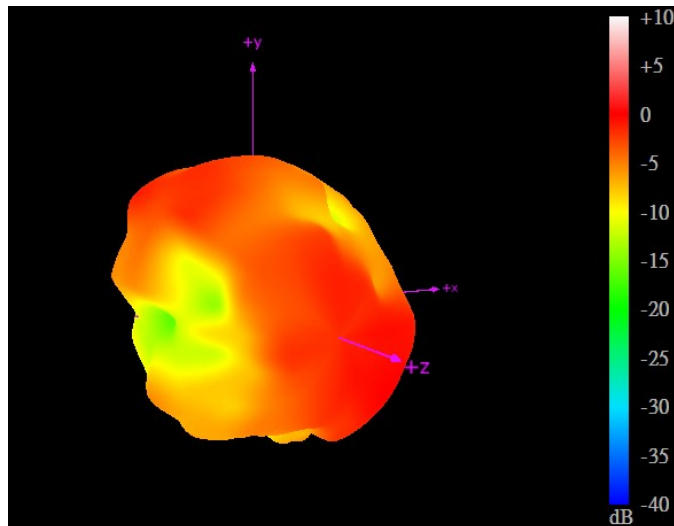

5550MHz

3.2.26. 2D Radiation Pattern (Wi-Fi_MIMO2 with 3M cable length in free space)

XY Plane

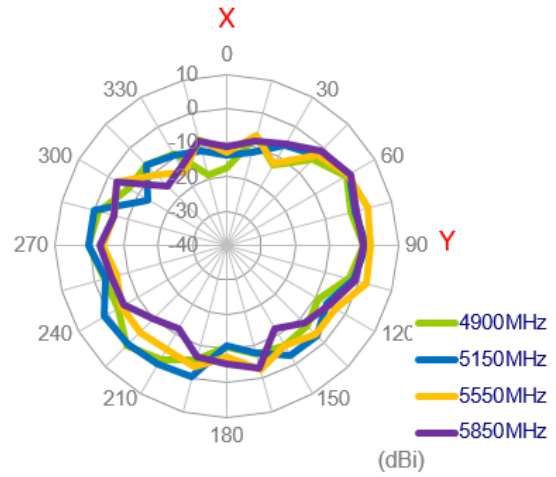
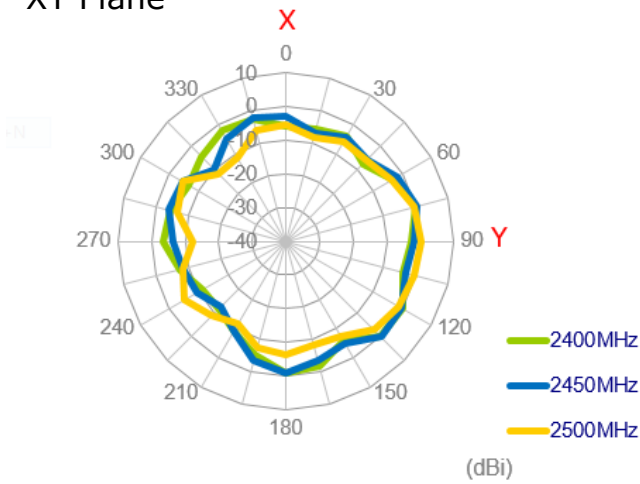

XZ Plane

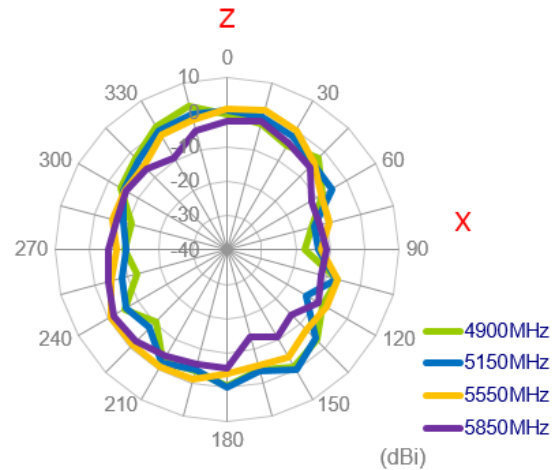
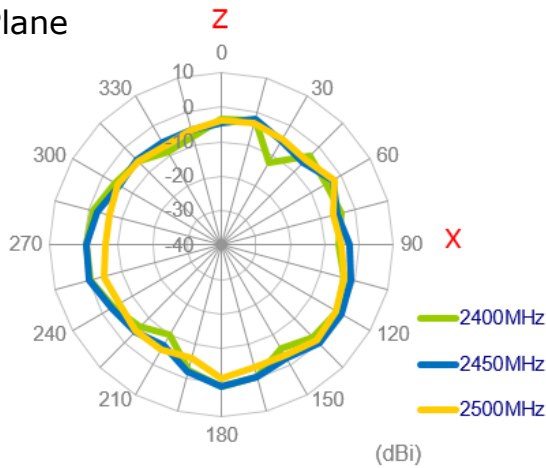

YZ Plane

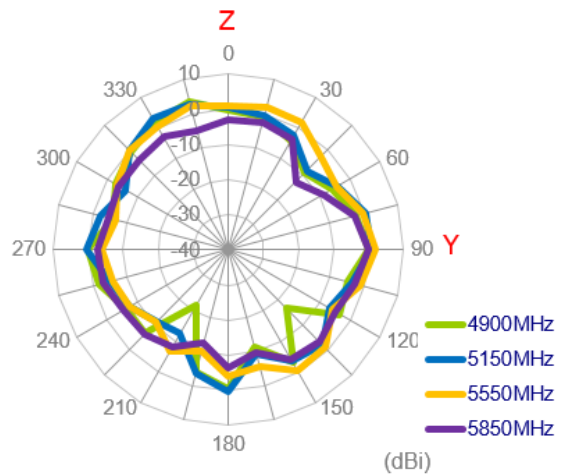
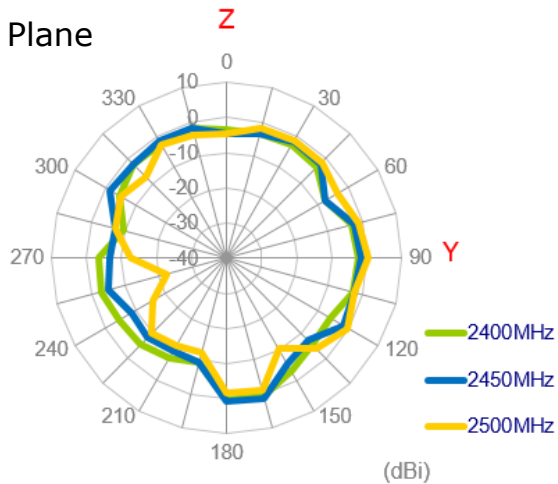

3.2.27. 3D Radiation Pattern (Wi-Fi_MIMO2 with 1M cable length in free space)

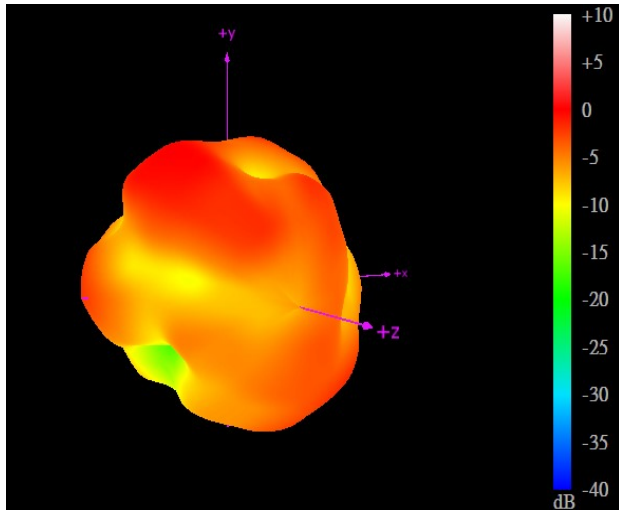

2450MHz

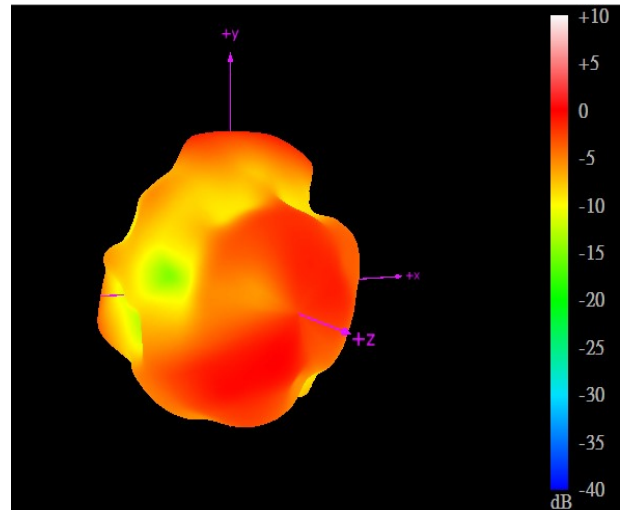

5550MHz

3.2.28. Test Setup for Antenna Radiation Pattern

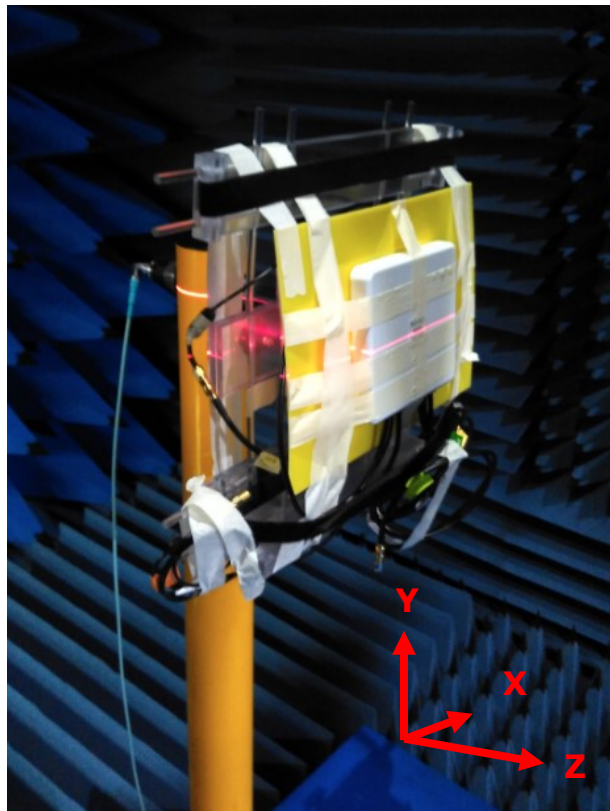

On the AB

3.2.29. 2D Radiation Pattern (LTE_MIMO1 with 1M cable length on ABS)

XY Plane

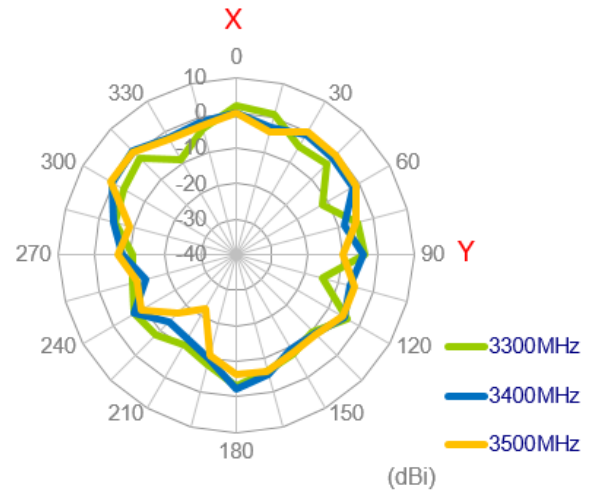
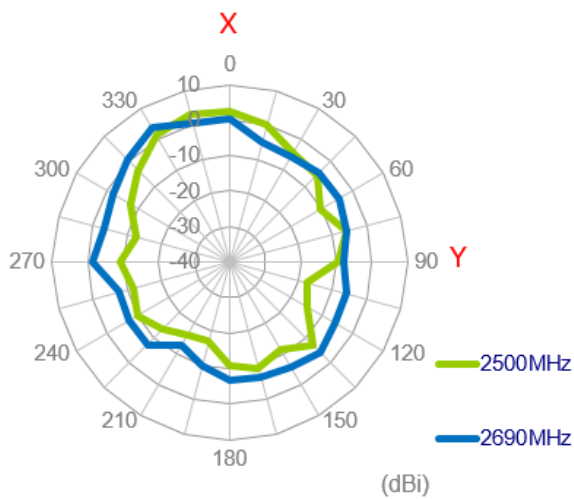
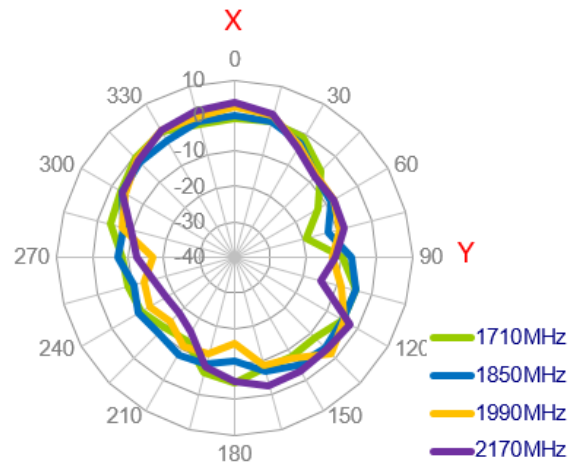
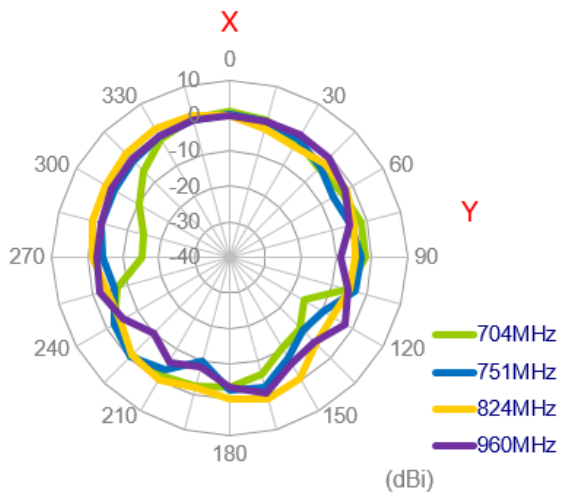

XZ Plane

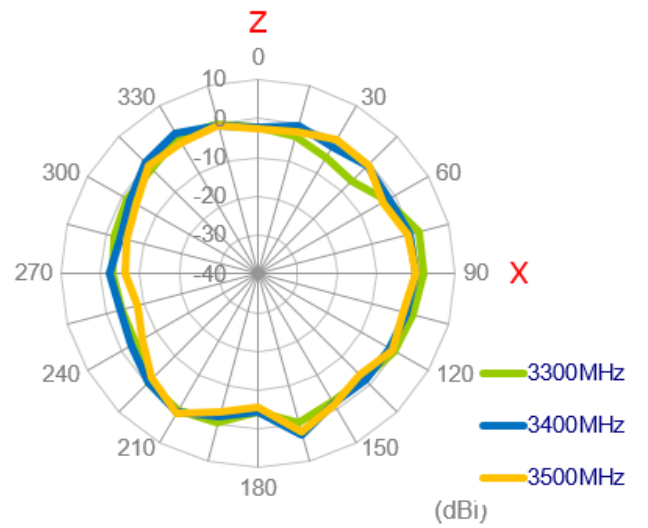
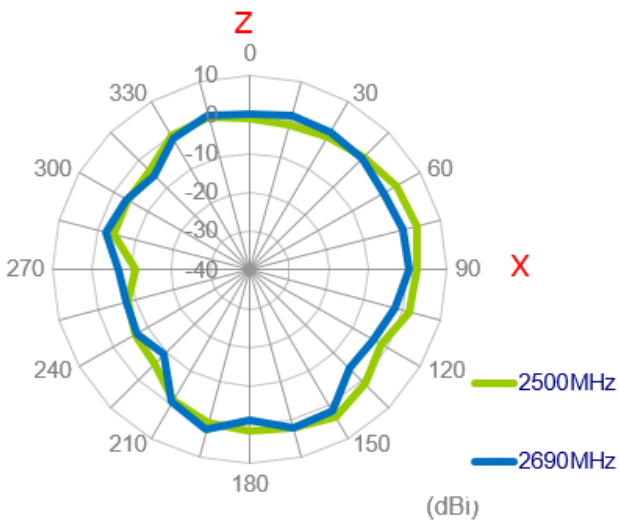
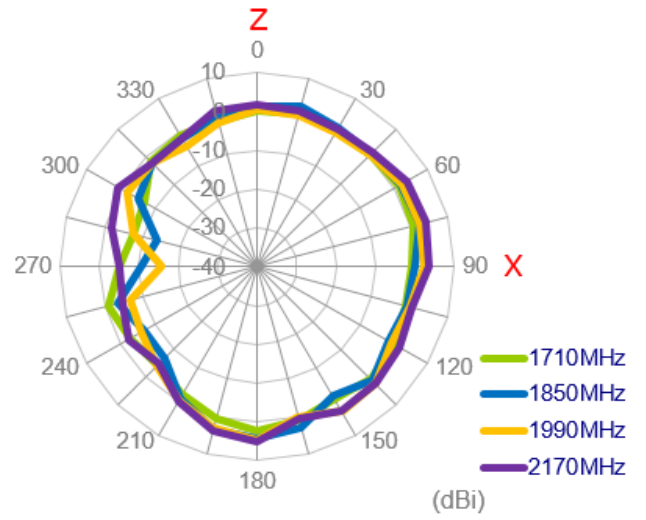
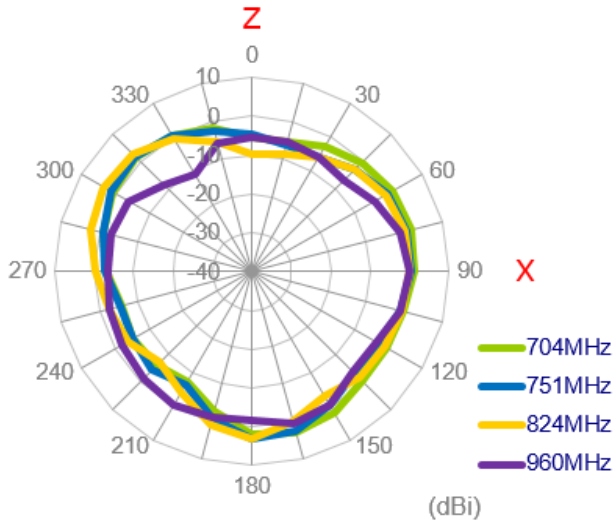

YZ Plane

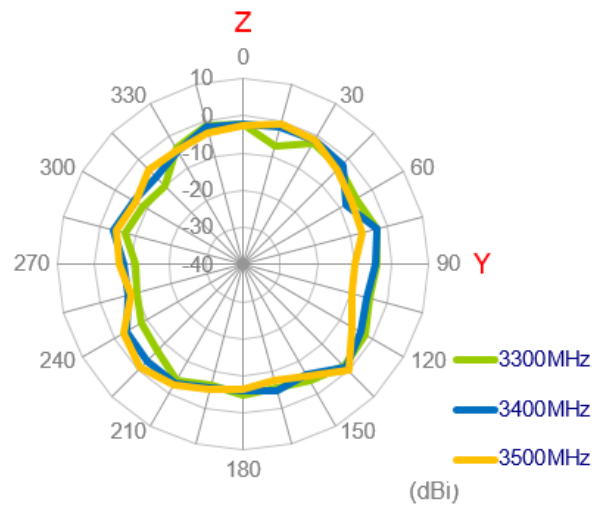
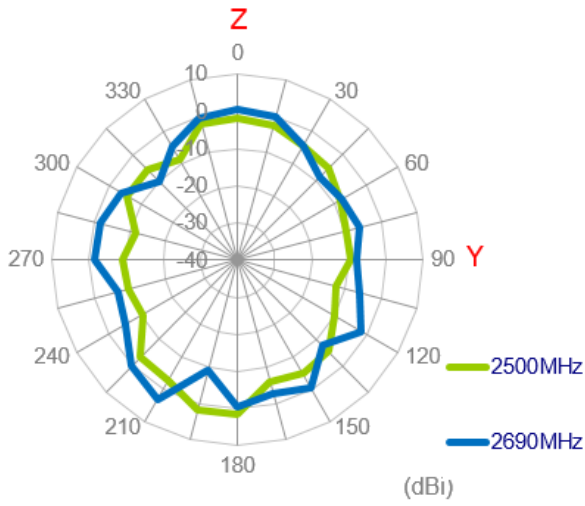
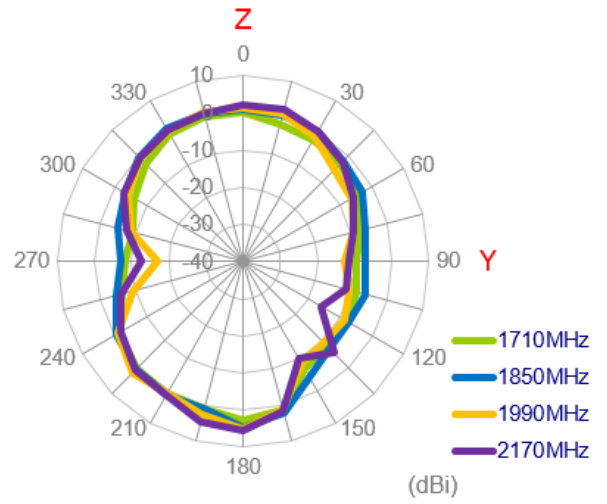
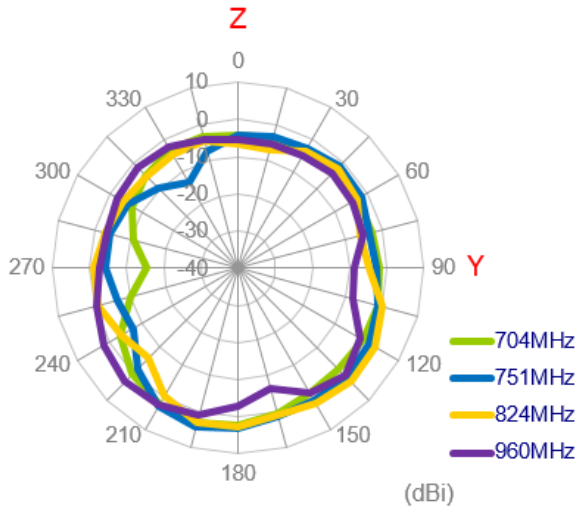

3.2.30. 3D Radiation Pattern (LTE_MIMO1 with 1M cable length on ABS)

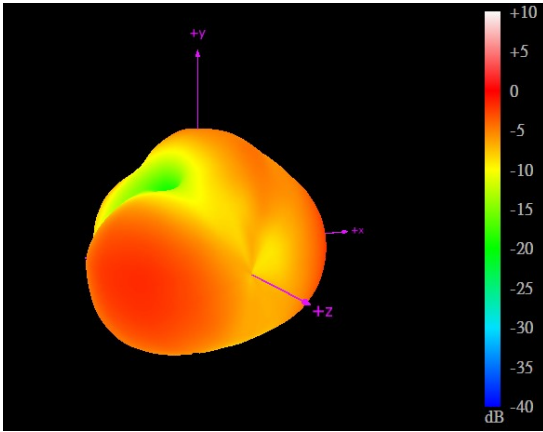

704MHz

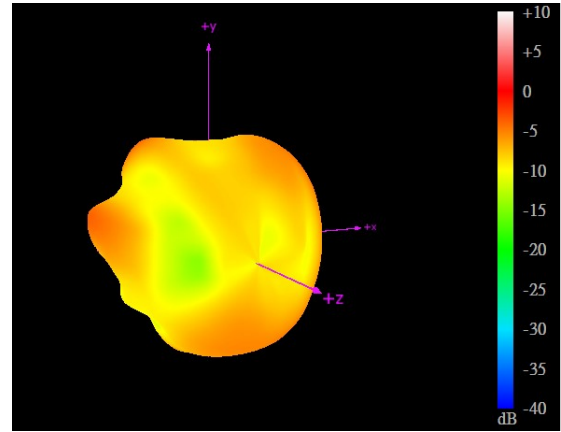

960MHz

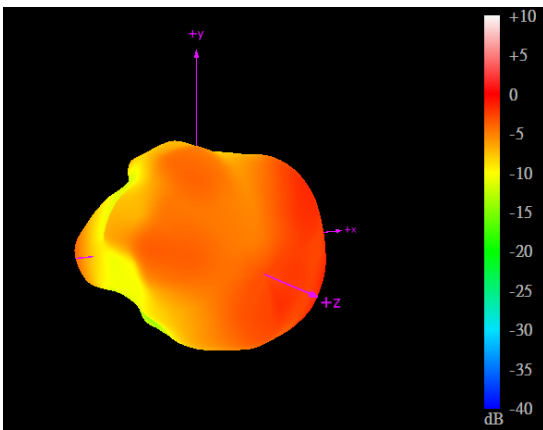

1710MHz

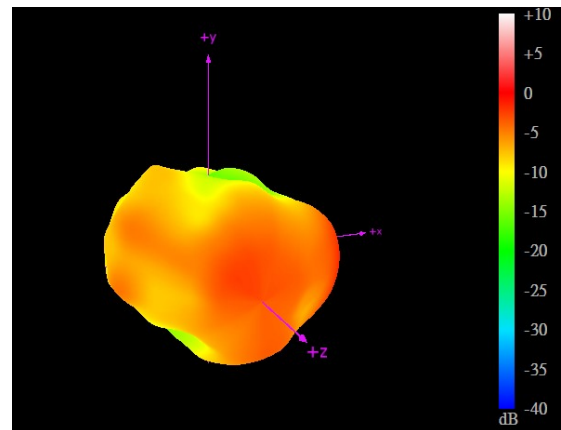

2170MHz

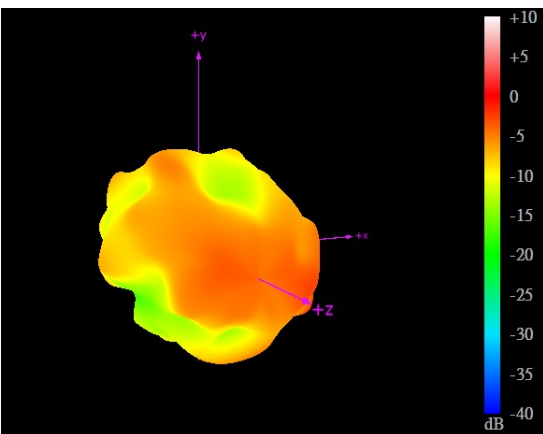

2690MHz

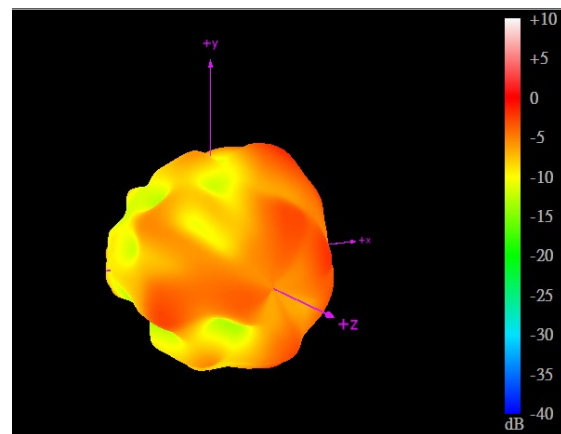

3500MHz

3.2.31. 2D Radiation Pattern (LTE_MIMO2 with 1M cable length on ABS)

XY Plane

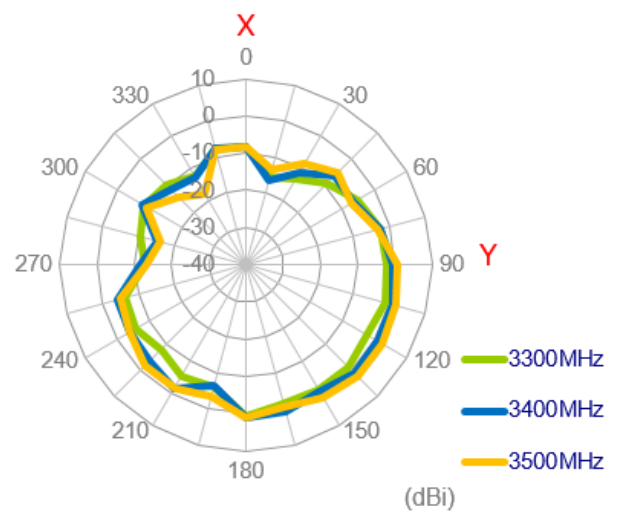
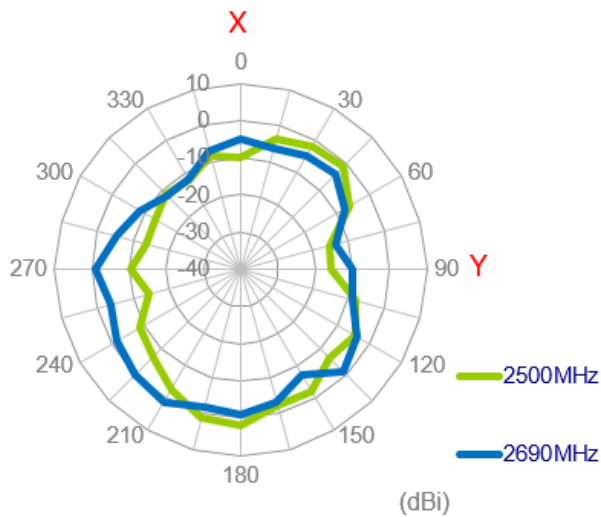
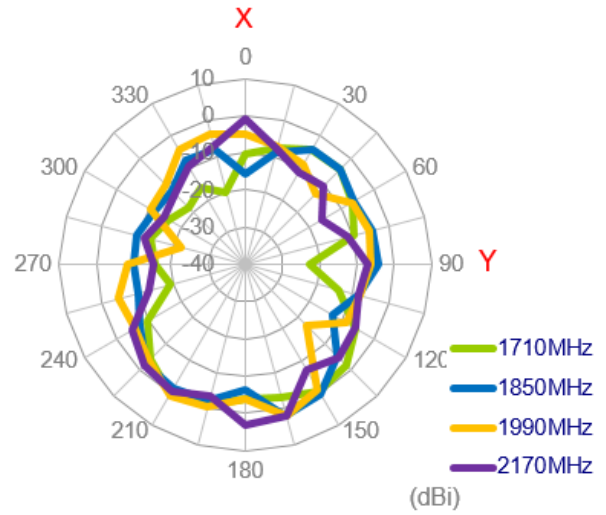
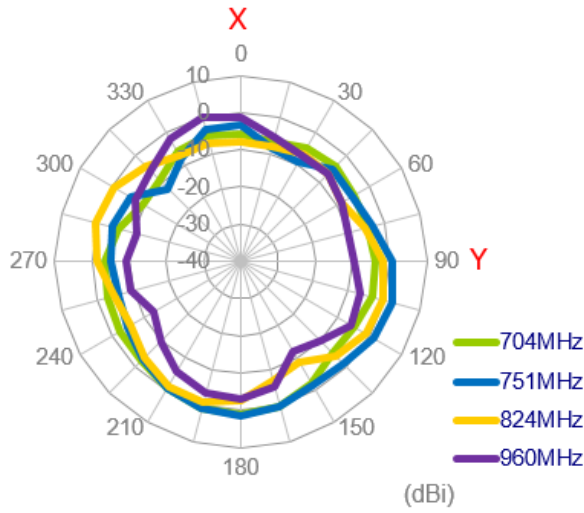

XZ Plane

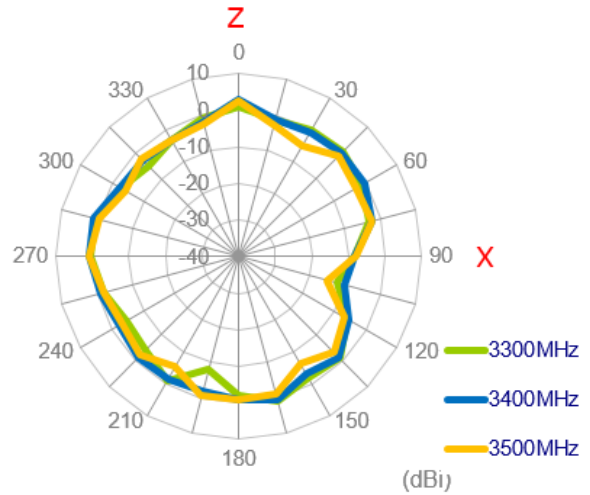
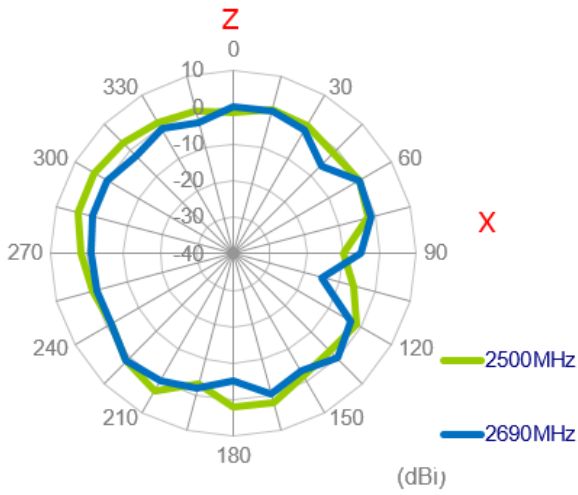
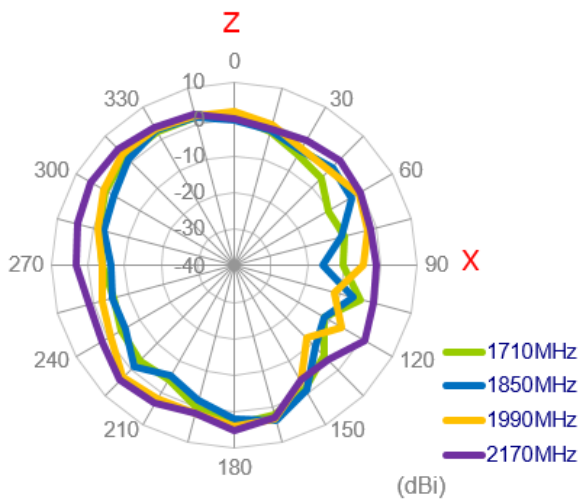
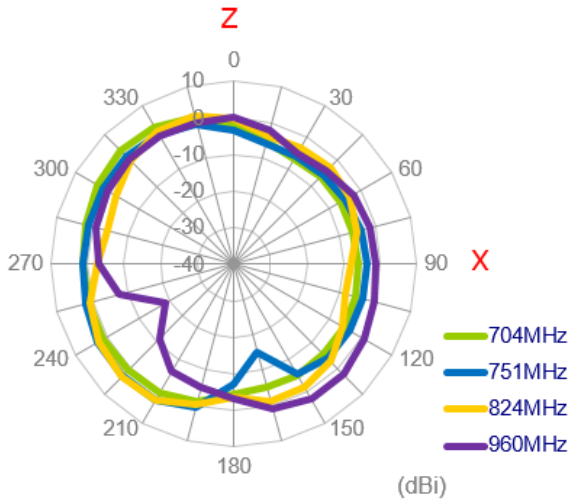

YZ Plane

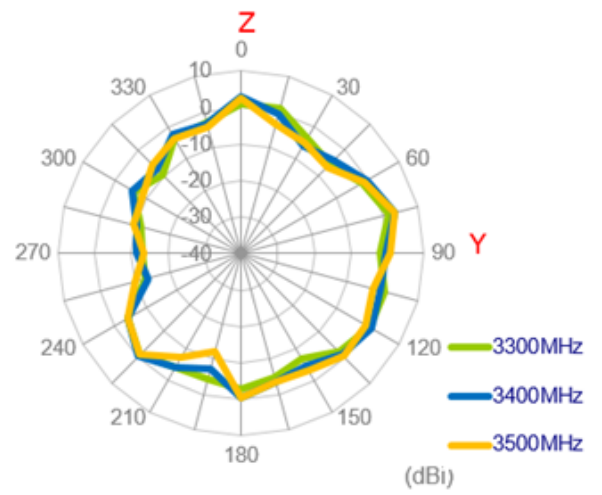
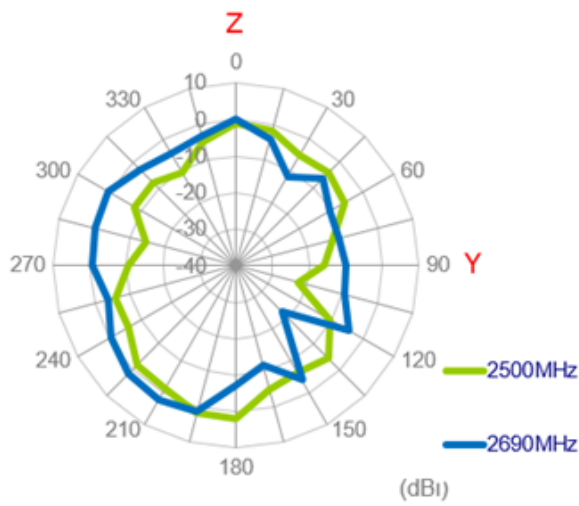
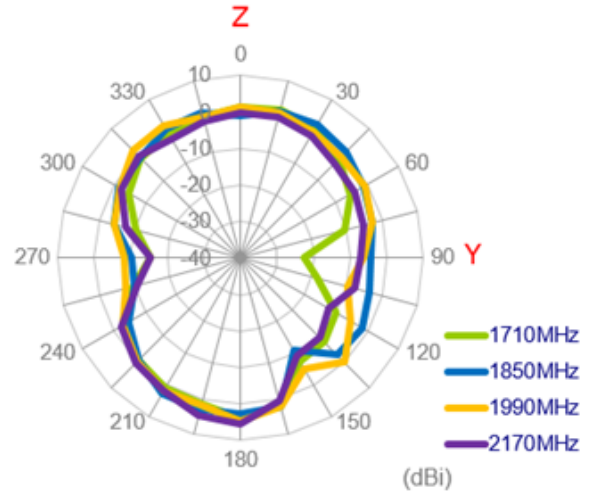
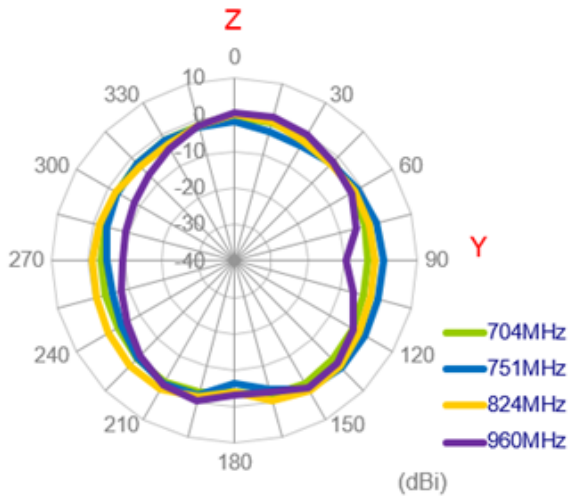

3.2.32. 3D Radiation Pattern (LTE_MIMO2 with 1M cable length on ABS)

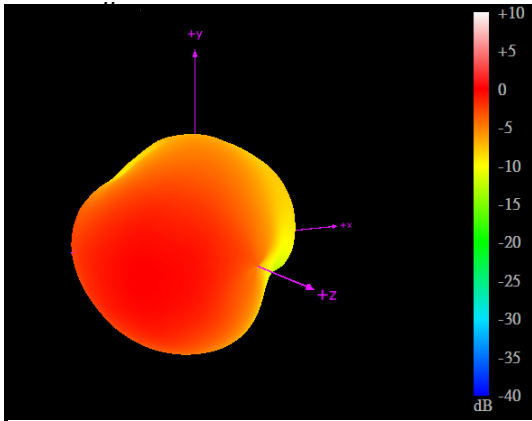

704MHz

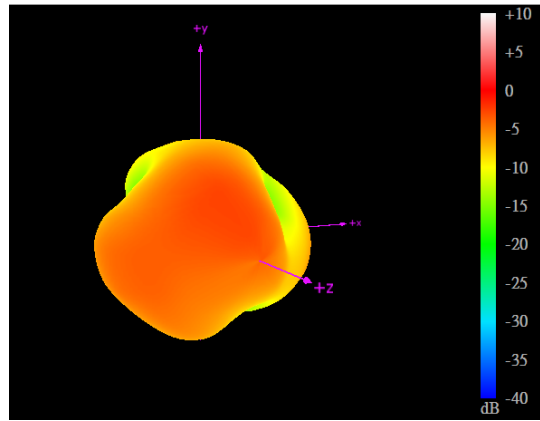

960MHz

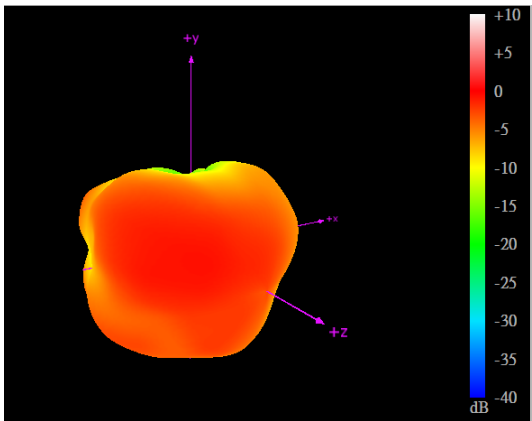

1710MHz

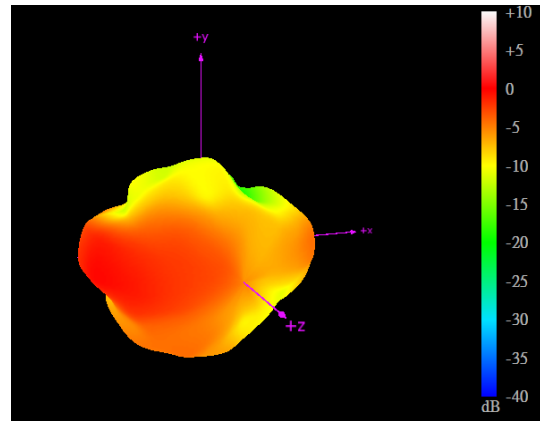

2170MHz

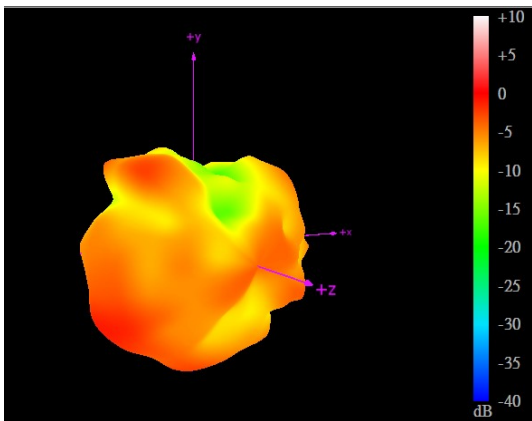

2690MHz

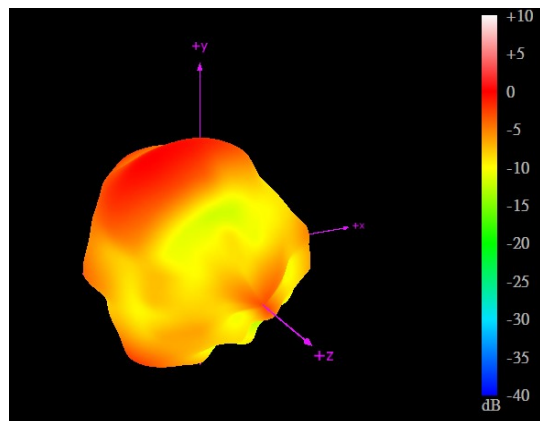

3500MHz

3.2.33. 2D Radiation Pattern (Wi-Fi_MIMO1 with 1M cable length on ABS)

XY Plane

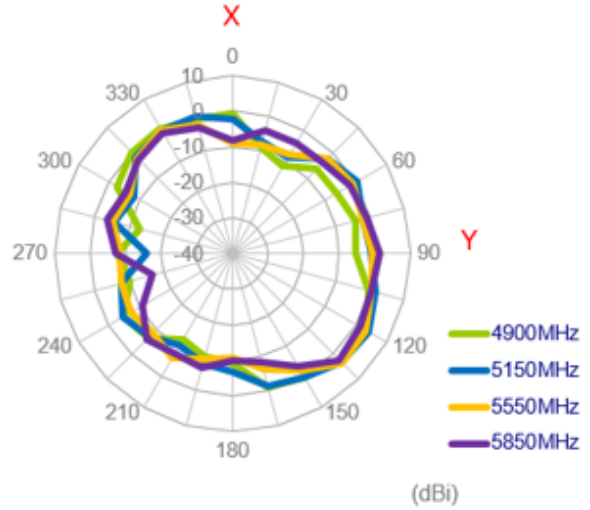
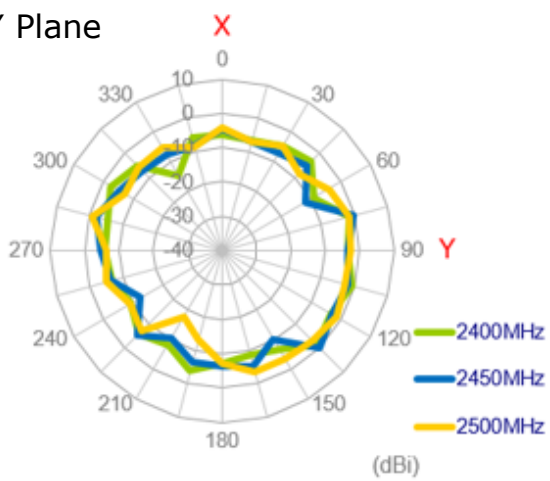

XZ Plane

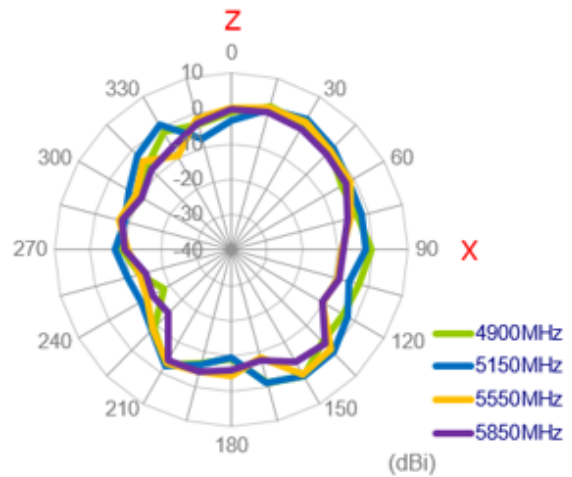
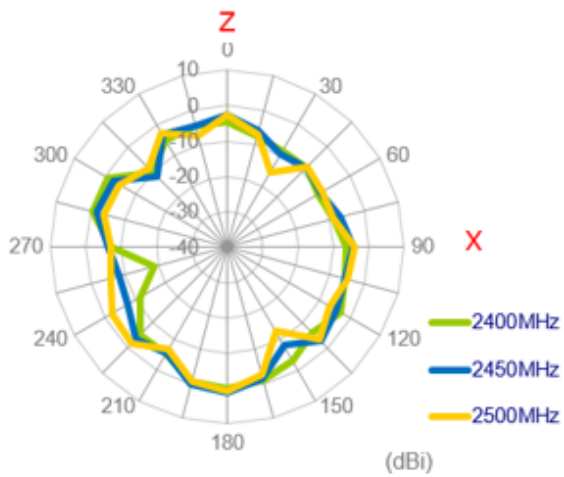

YZ Plane

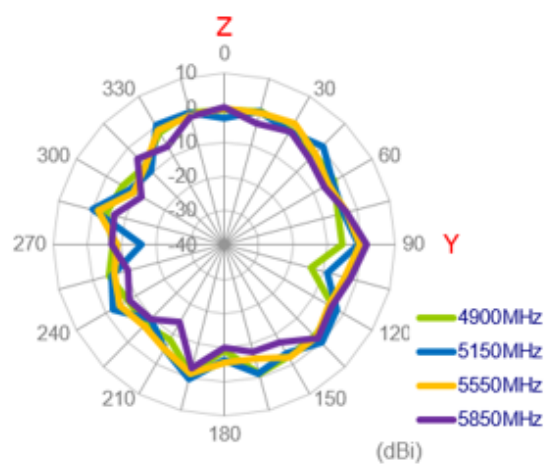
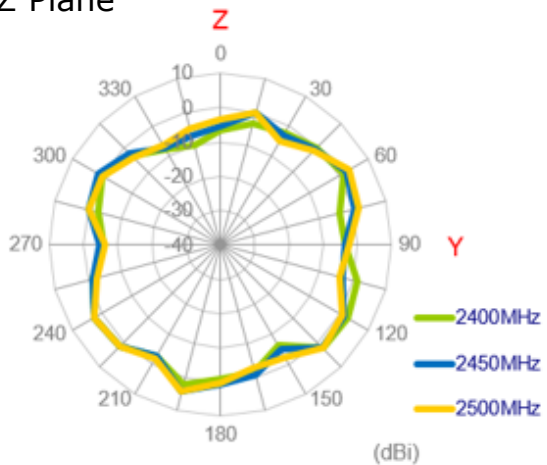

3.2.34. 3D Radiation Pattern (Wi-Fi_MIMO1 with 1M cable length on ABS)

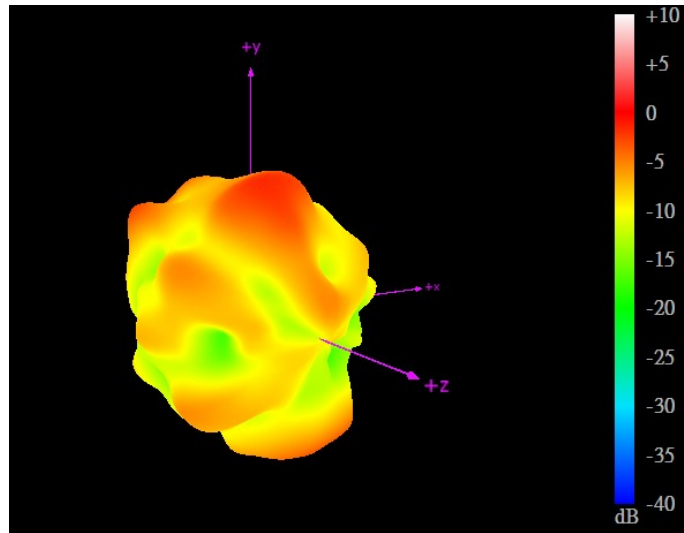

2450MHz

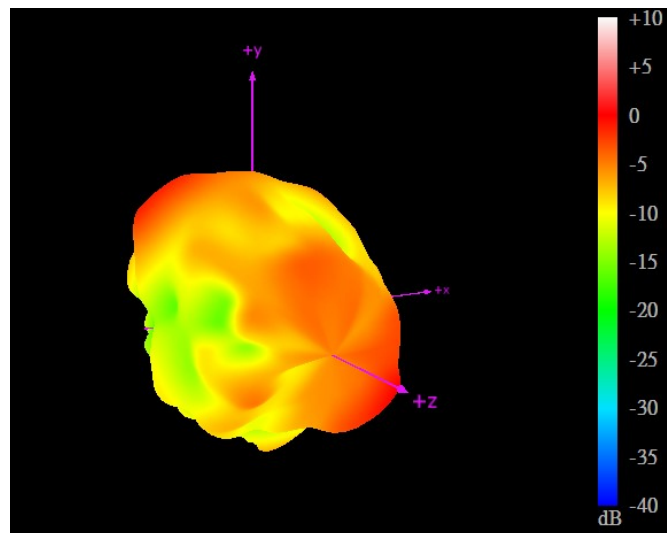

5550MHz

3.2.35. 2D Radiation Pattern (Wi-Fi_MIMO2 with 3M cable length on ABS)

XY Plane

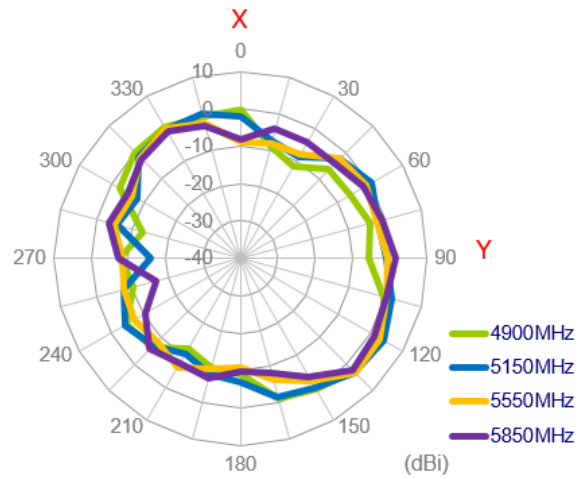
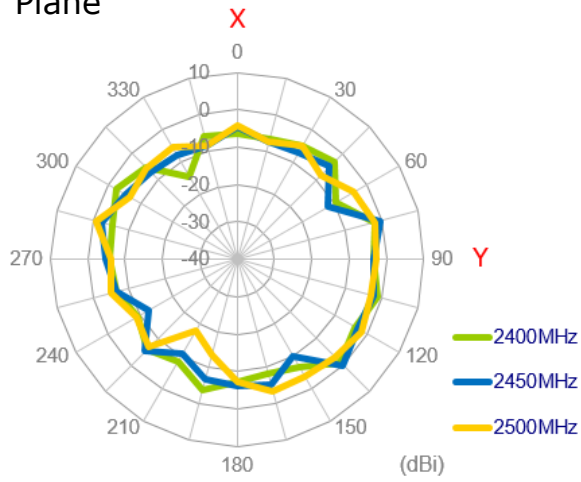

XZ Plane

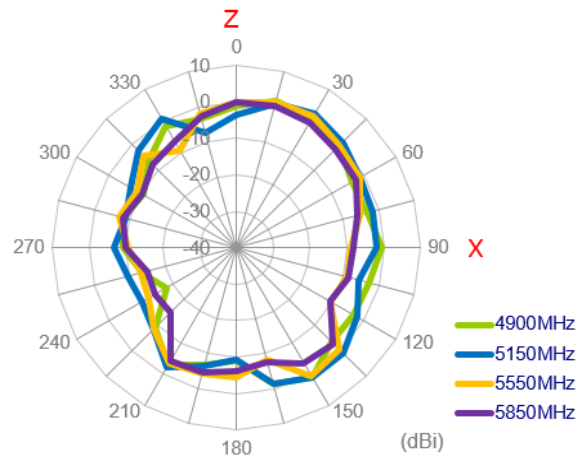
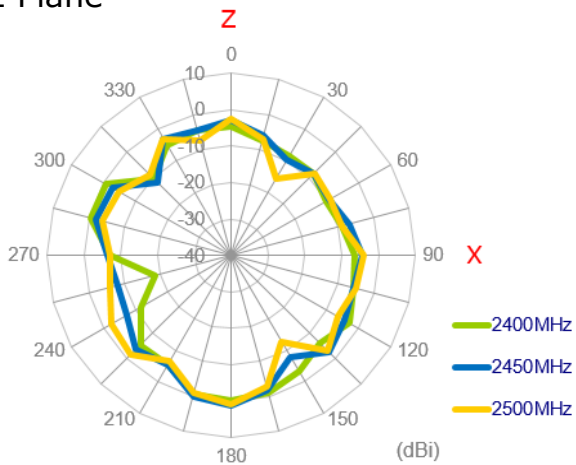

YZ Plane

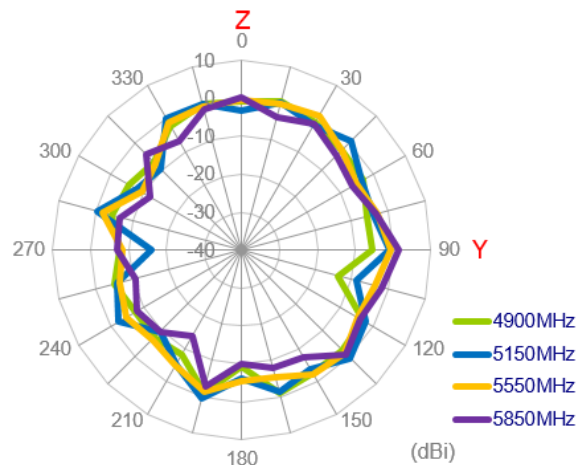
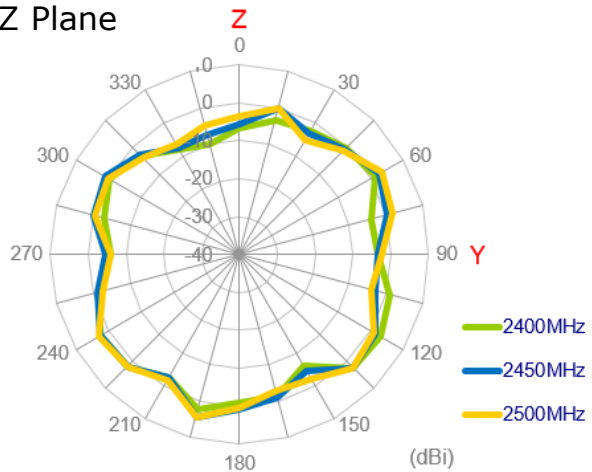

3.2.36. 3D Radiation Pattern (Wi-Fi_MIMO2 with 1M cable length on ABS)

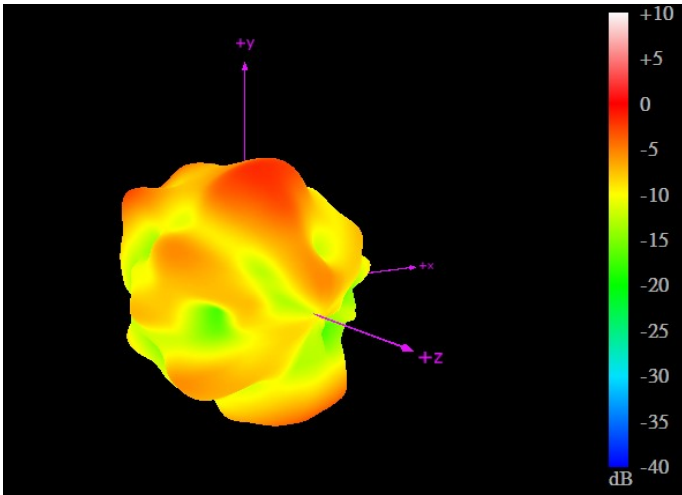

2450MHz

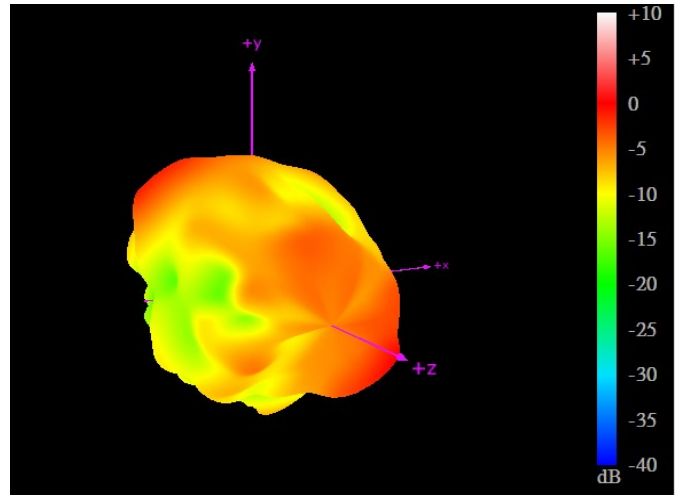

5550MHz

3.2.37. Test Setup for Antenna Radiation Pattern



On glass

3.2.38. 2D Radiation Pattern (LTE_MIMO1 with 1M cable length on glass)

XY Plane

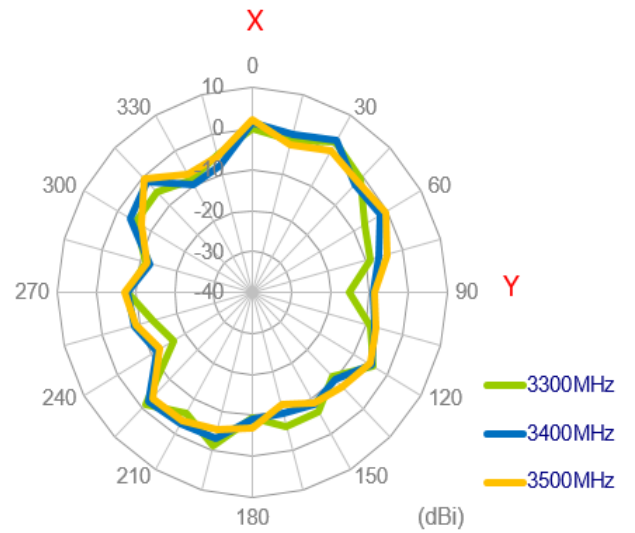
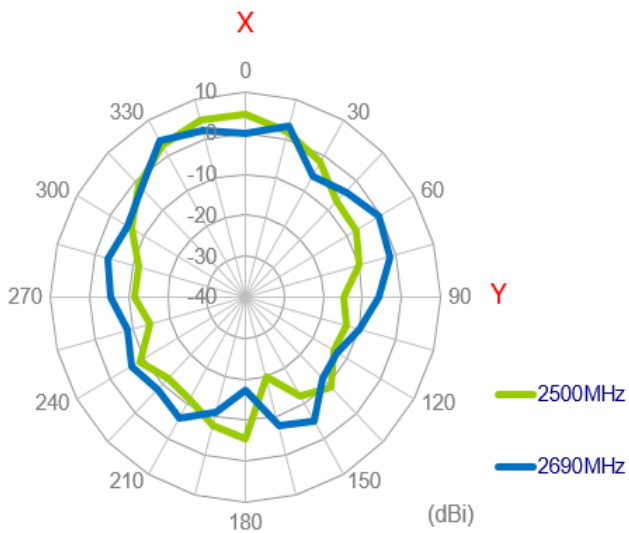
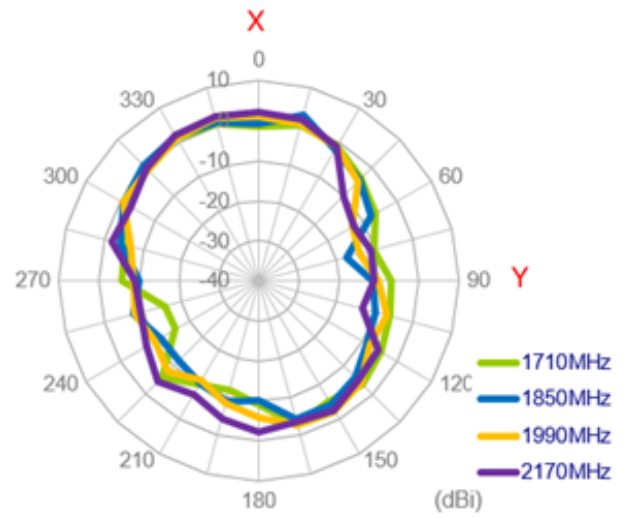
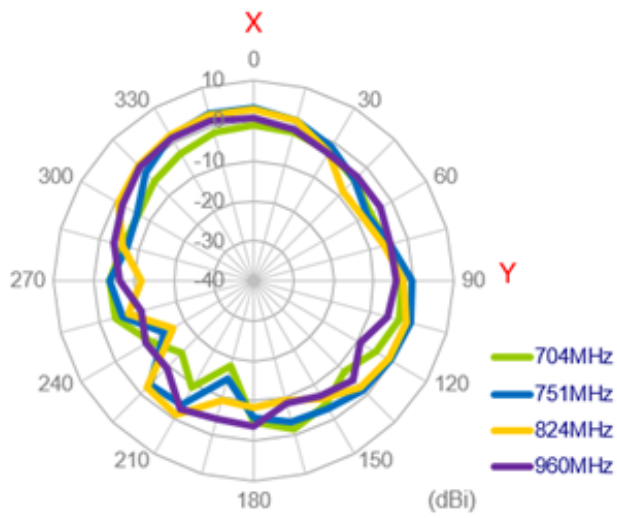

XZ Plane

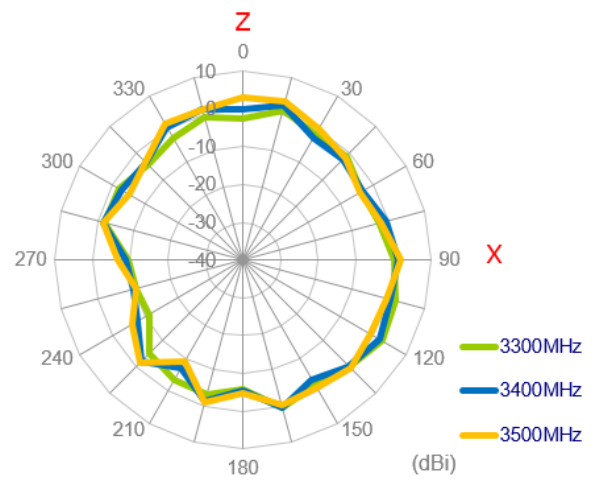
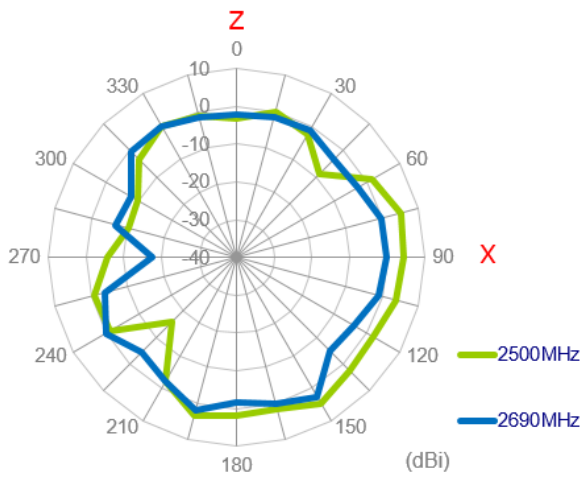
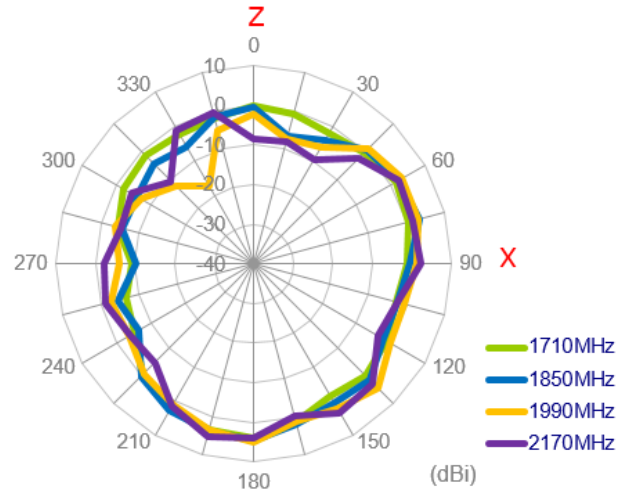
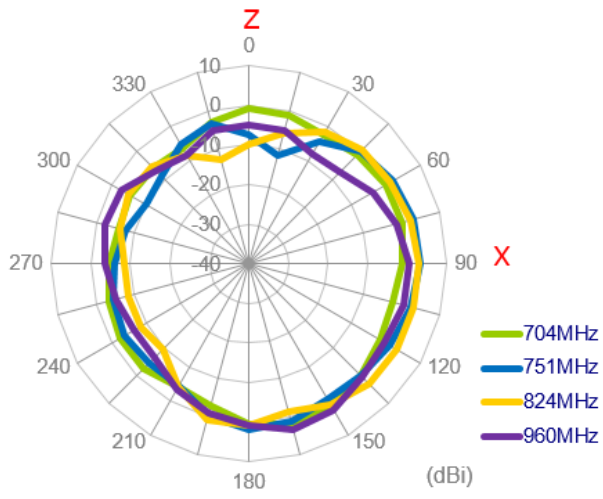

YZ Plane

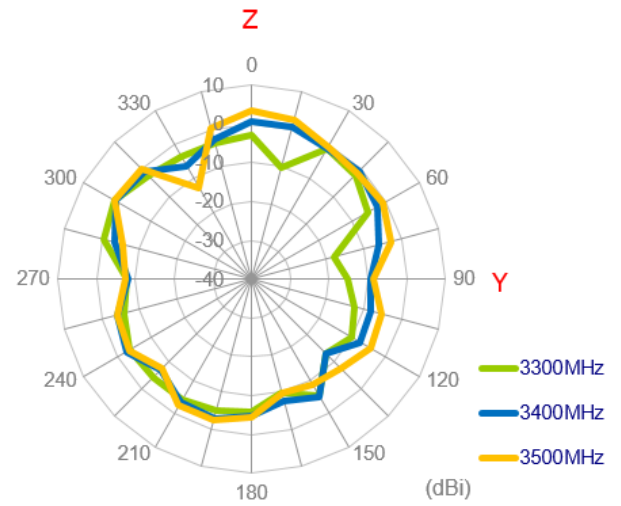
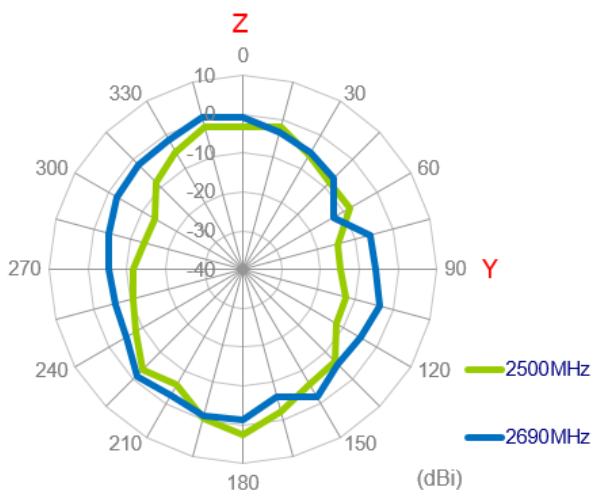
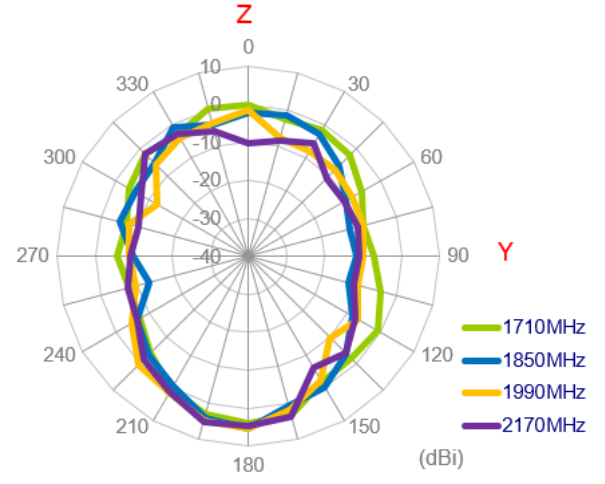
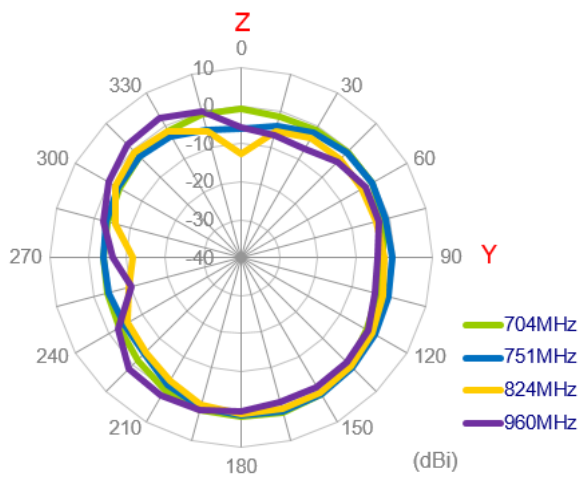

3.2.39. 3D Radiation Pattern (LTE_MIMO1 with 1M cable length o glass)

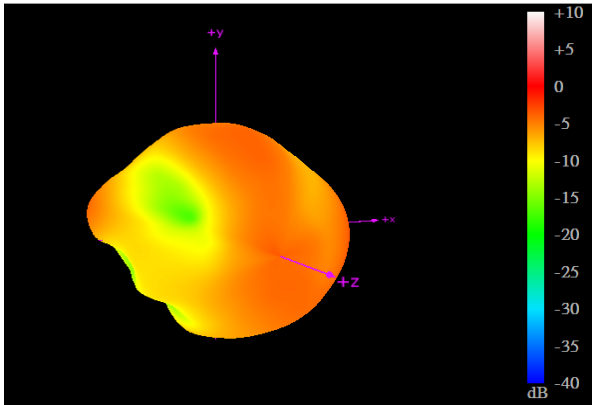

704MHz

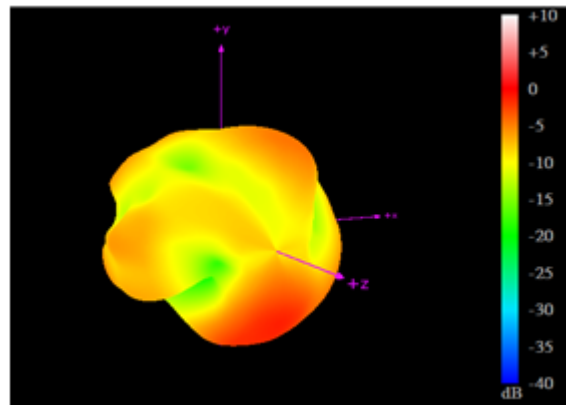

960MHz

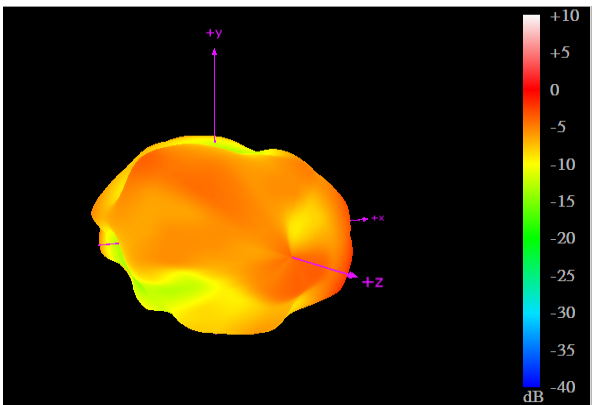

1710MHz

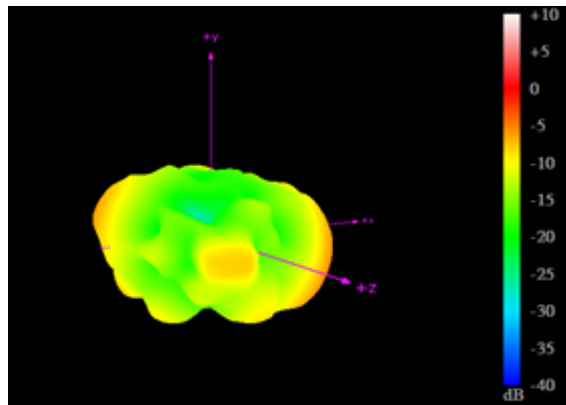

2170MHz

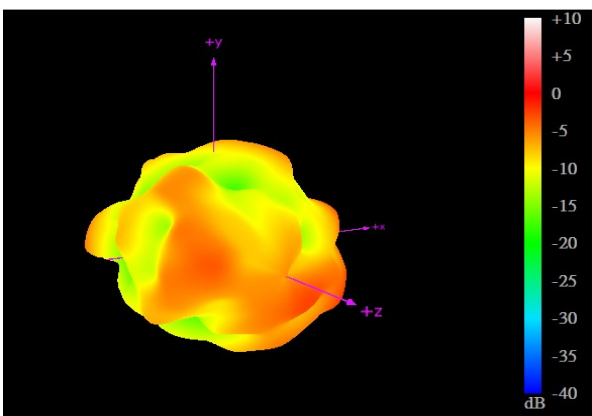

2690MHz

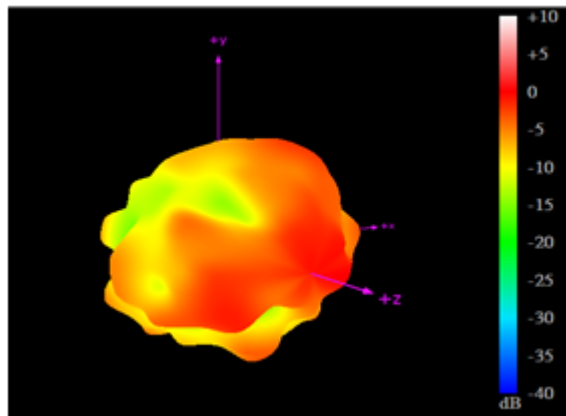

3500MHz

3.2.40. 2D Radiation Pattern (LTE_MIMO2 with 1M cable length on glass)

XY Plane

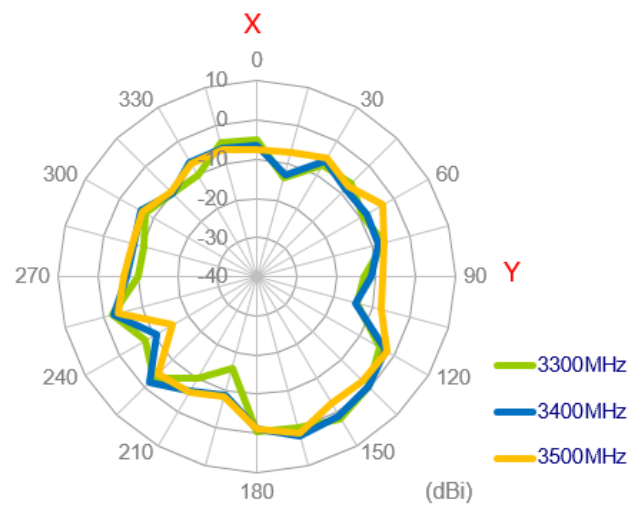
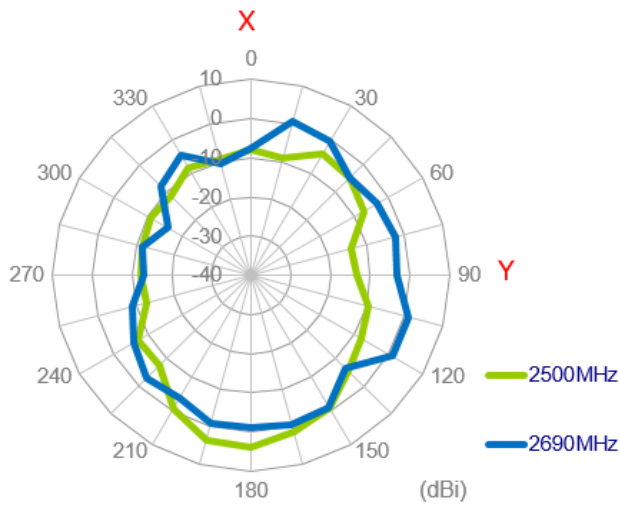
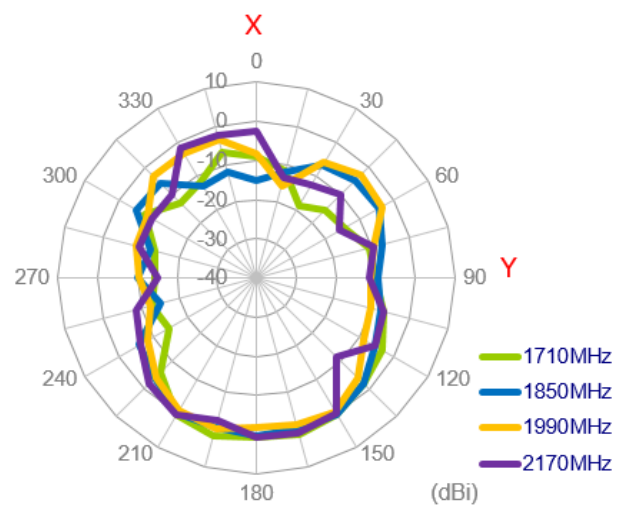
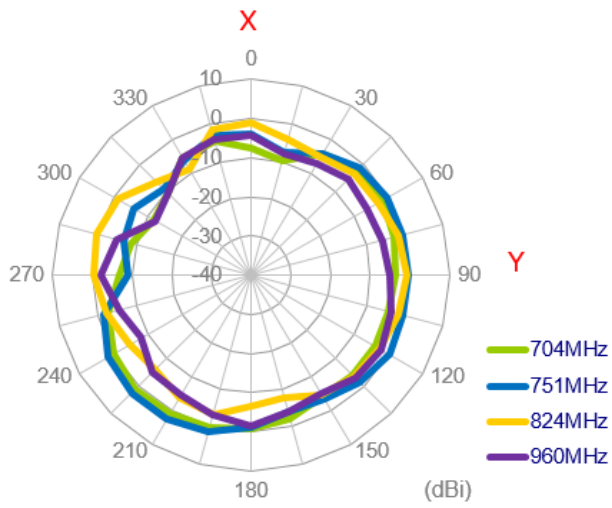

XZ Plane

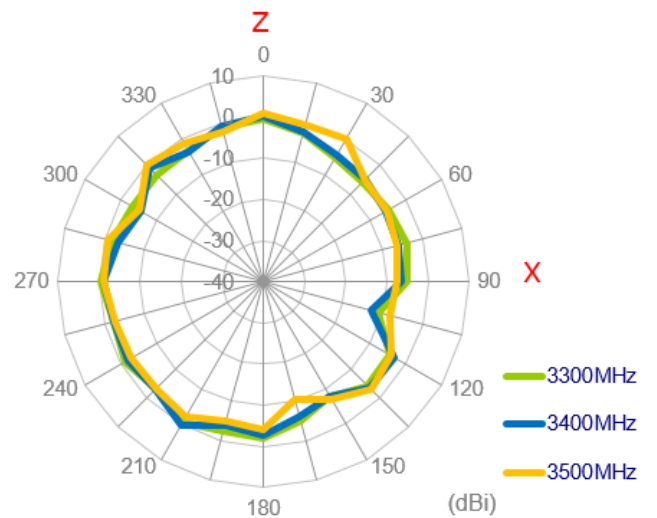
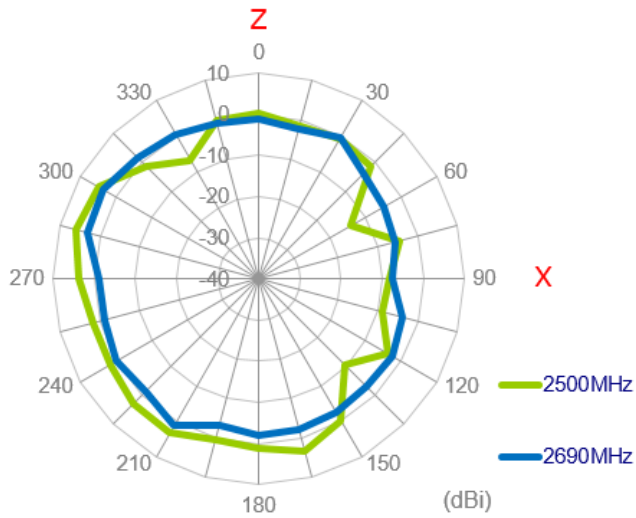
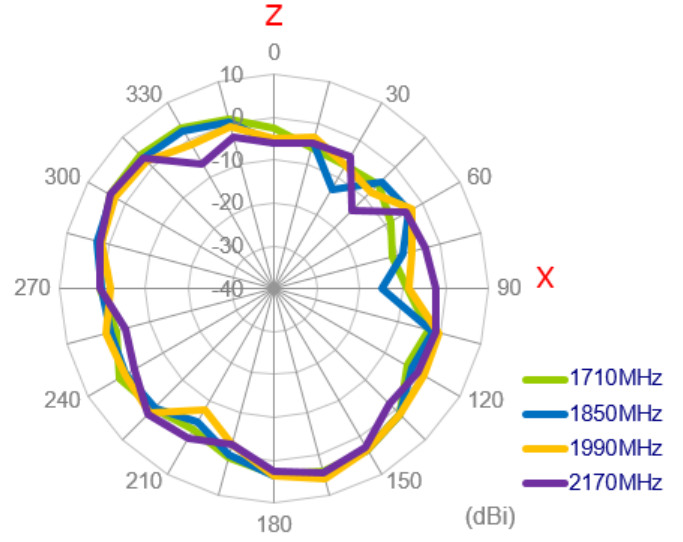
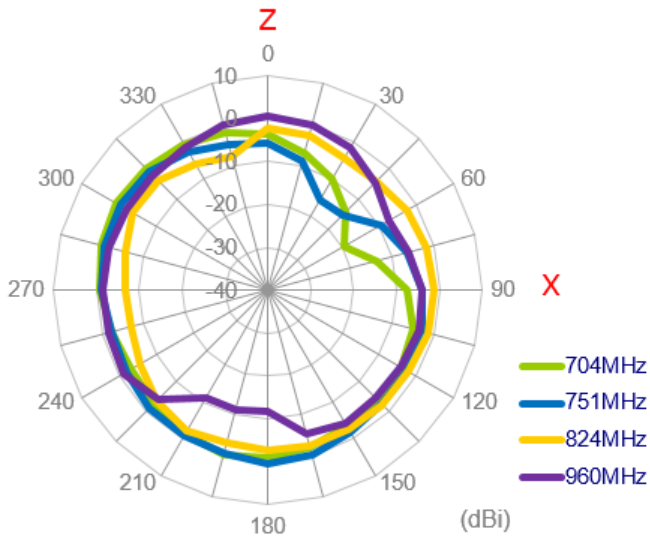

YZ Plane

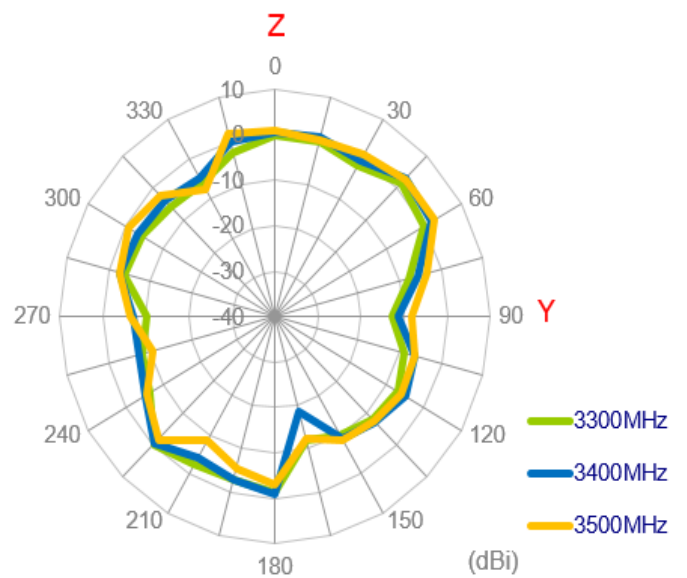
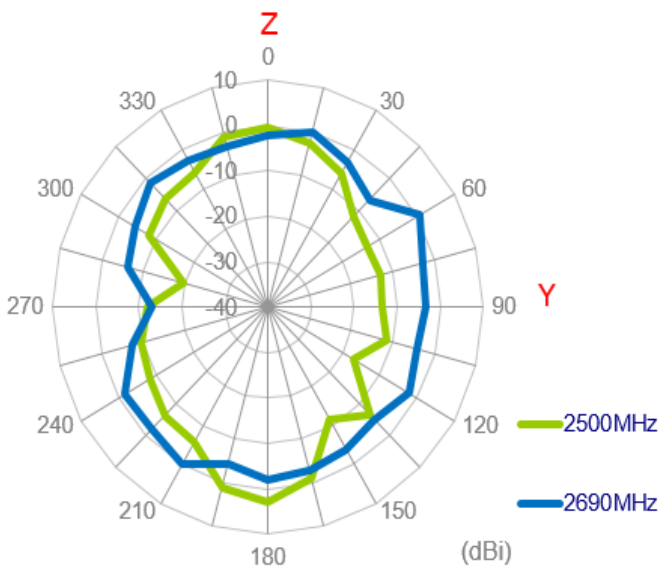
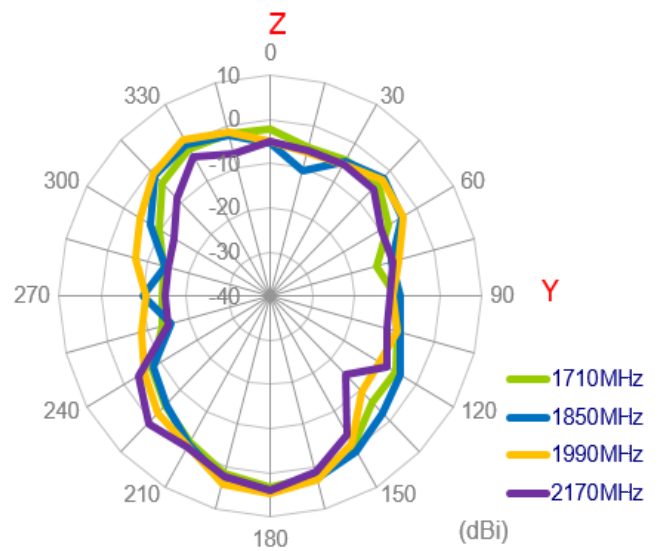
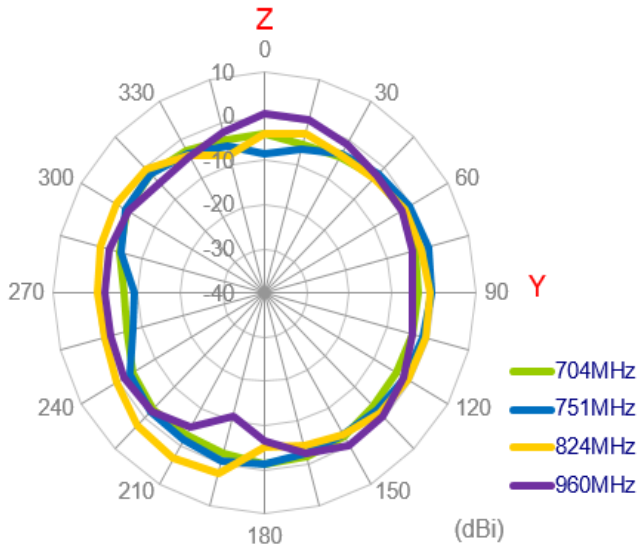

3.2.41. 3D Radiation Pattern (LTE_MIMO2 with 1M cable length on glass)

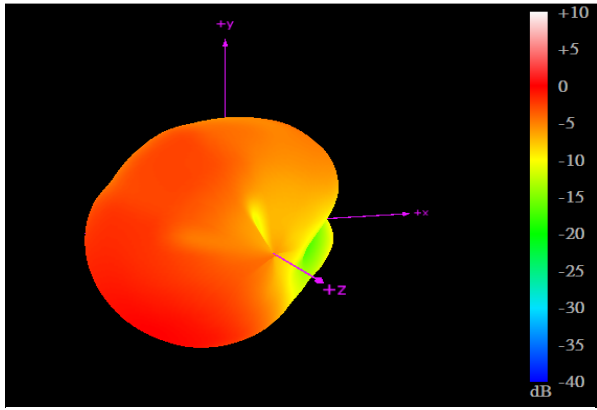

704MHz

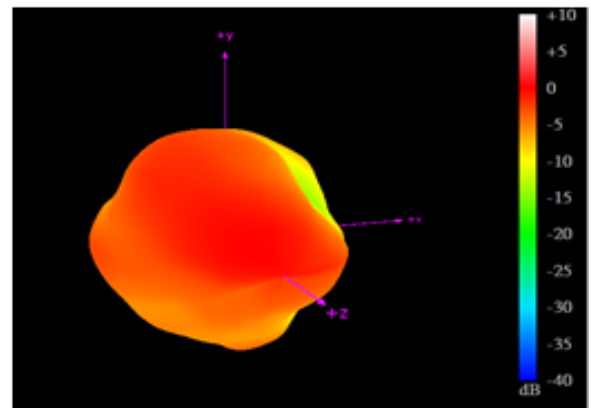

960MHz

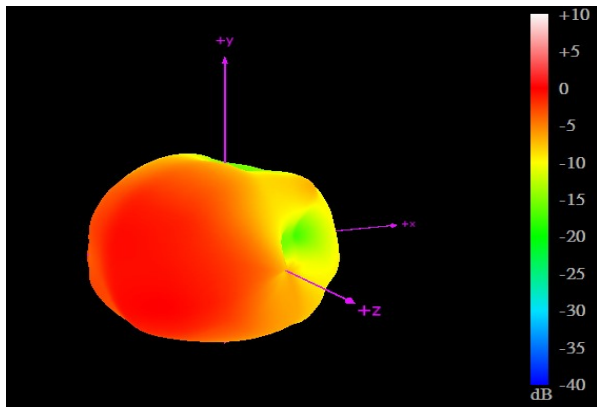

1710MHz

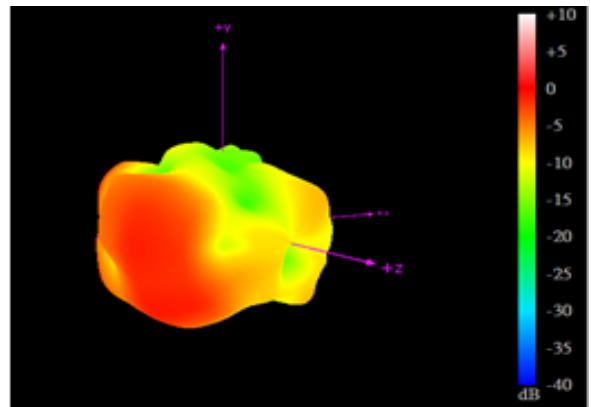

2170MHz

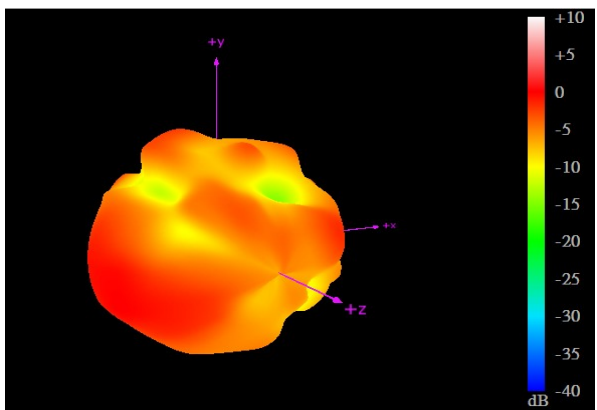

2690MHz

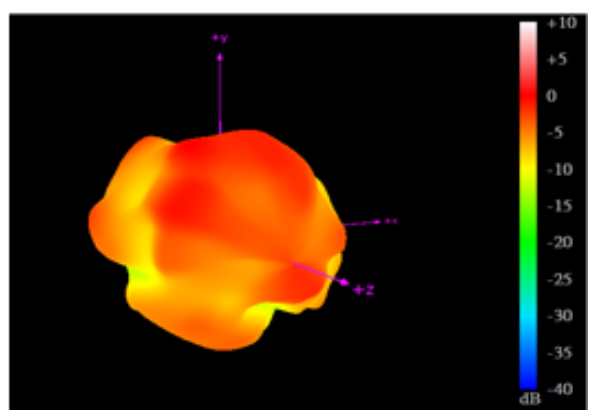

3500MHz

3.2.42. 2D Radiation Pattern (Wi-Fi_MIMO1 with 1M cable length on glass)

XY Plane

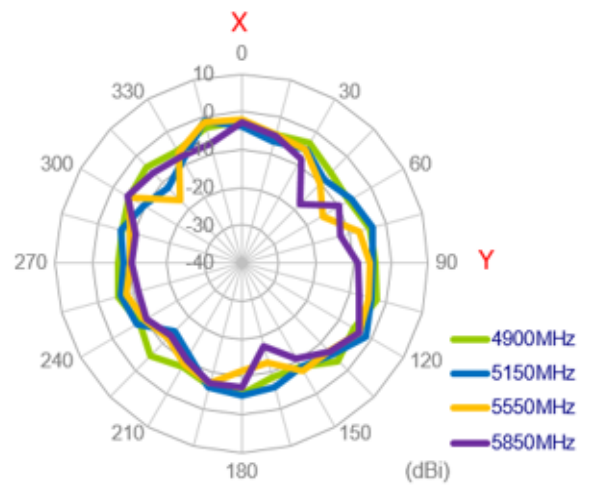
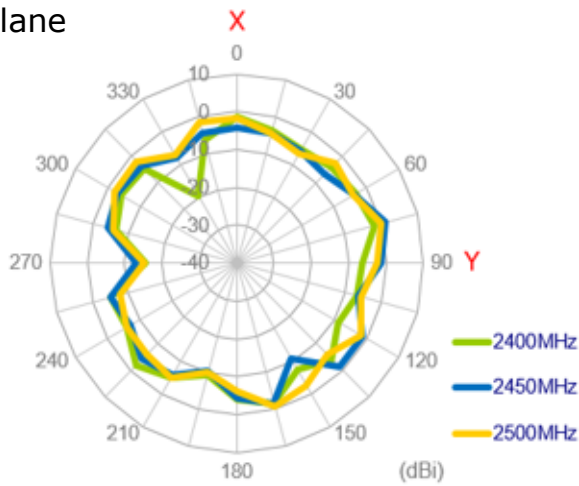

XZ Plane

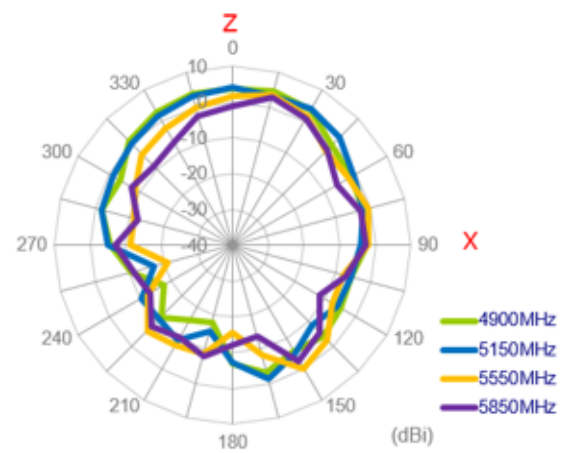
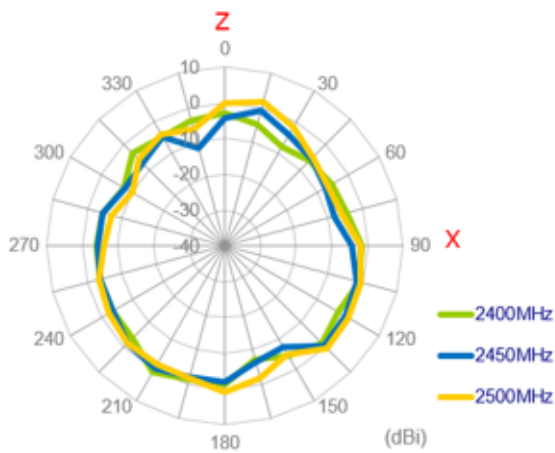

YZ Plane

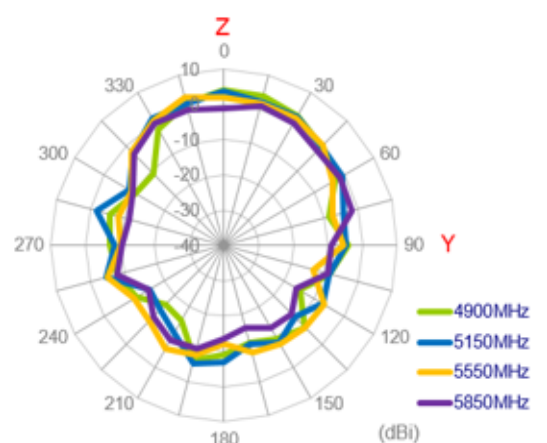
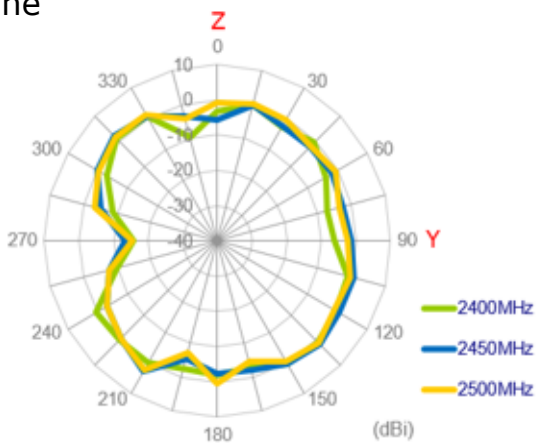

3.2.43. 3D Radiation Pattern (Wi-Fi_MIMO1 with 1M cable length on glass)

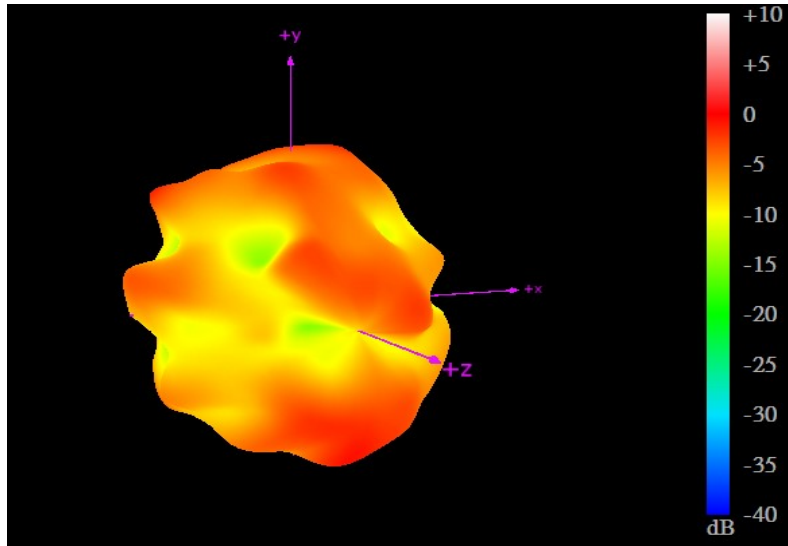

2450MHz

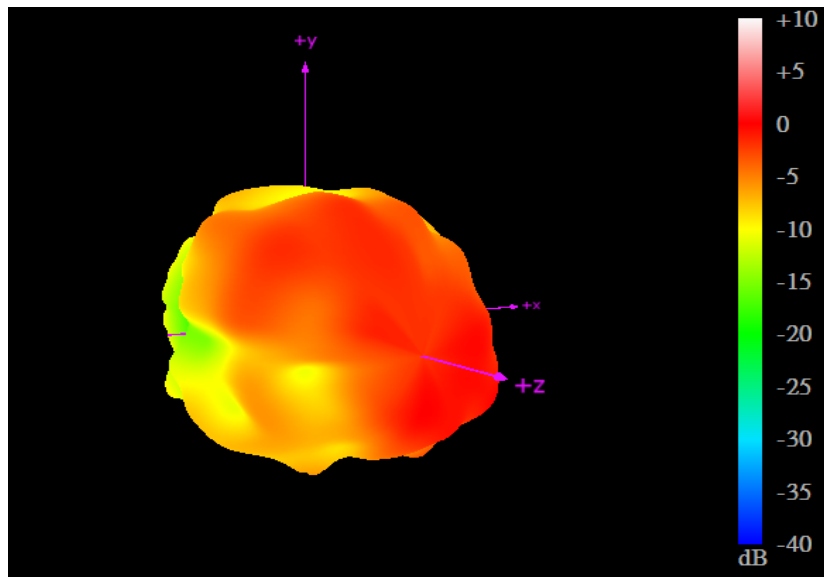

5550MHz

3.2.44. 2D Radiation Pattern (Wi-Fi_MIMO2 with 3M cable length on glass)

XY Plane

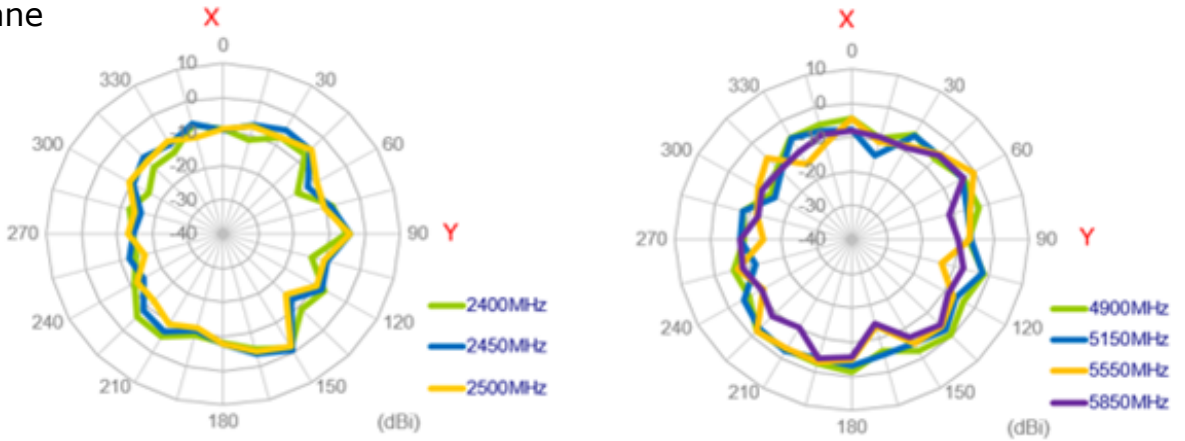

XZ Plane

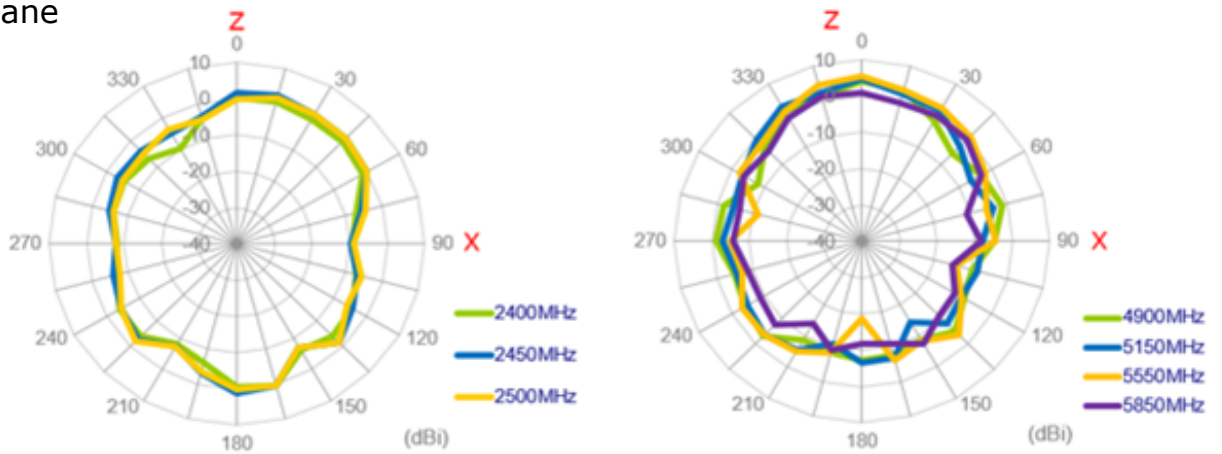

YZ Plane

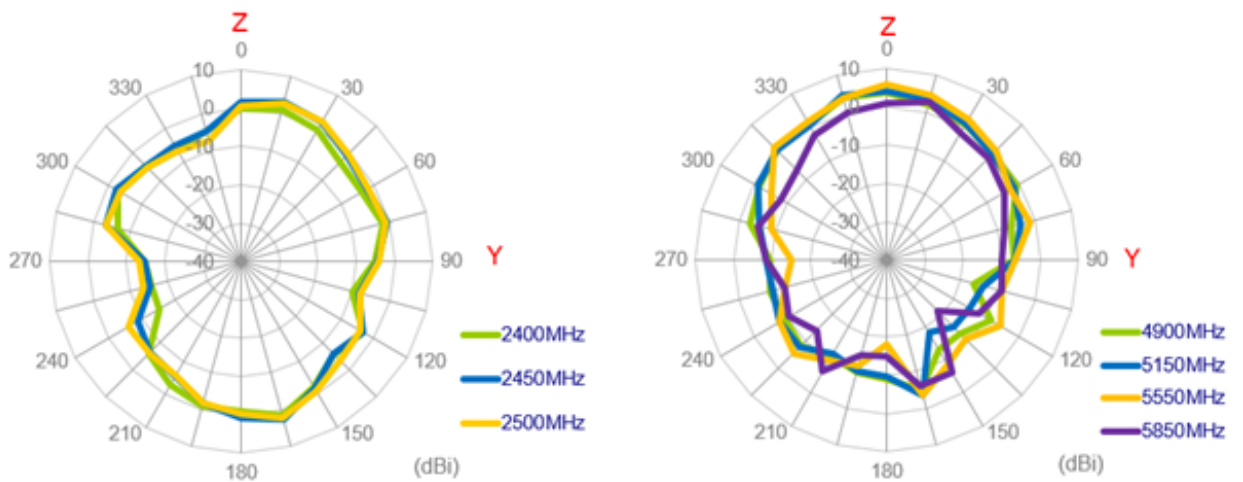

3.2.45. 3D Radiation Pattern (Wi-Fi_MIMO2 with 1M cable length on glass)

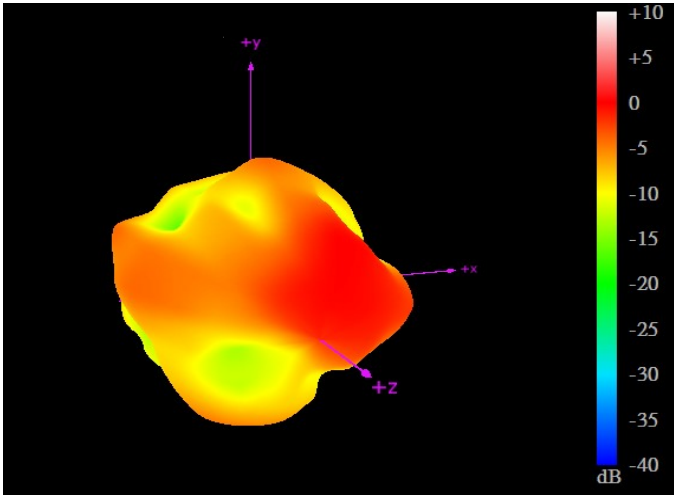

2450MHz

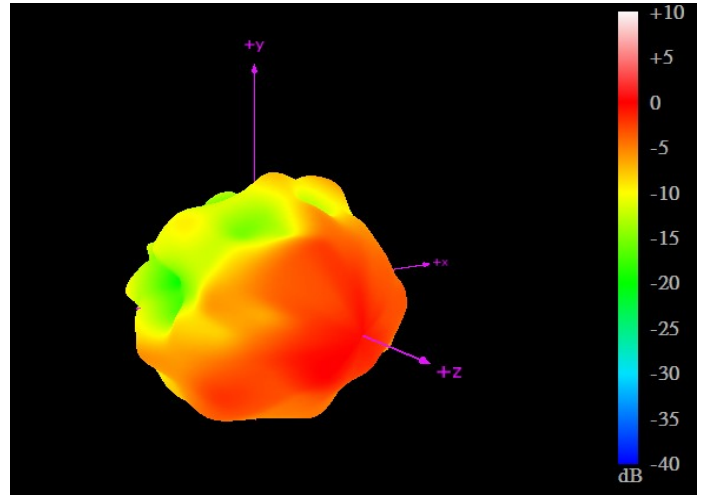

5550MHz

3.2.46. Test Setup for Antenna Radiation Pattern

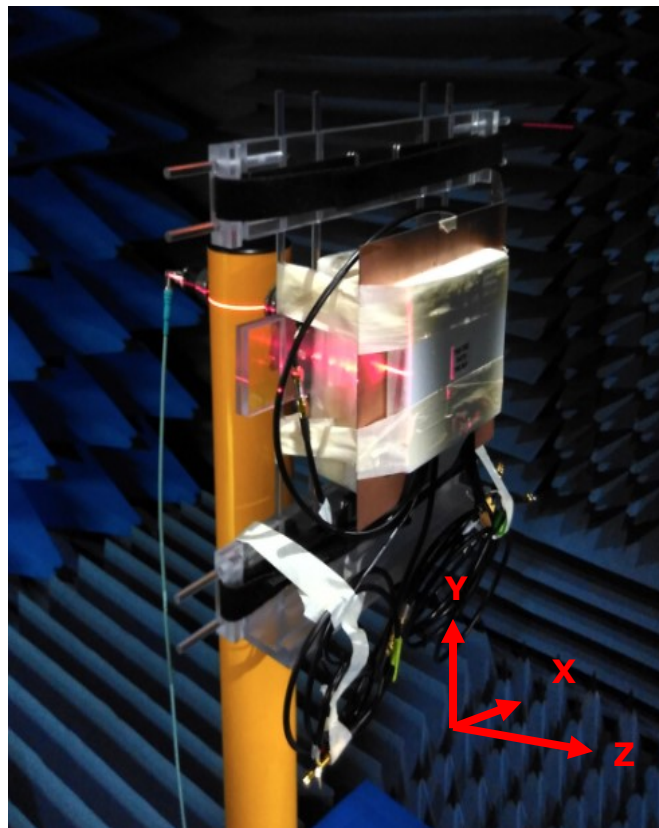

On metal

3.2.47. 2D Radiation Pattern (LTE_MIMO1 with 1M cable length on metal)

XY Plane

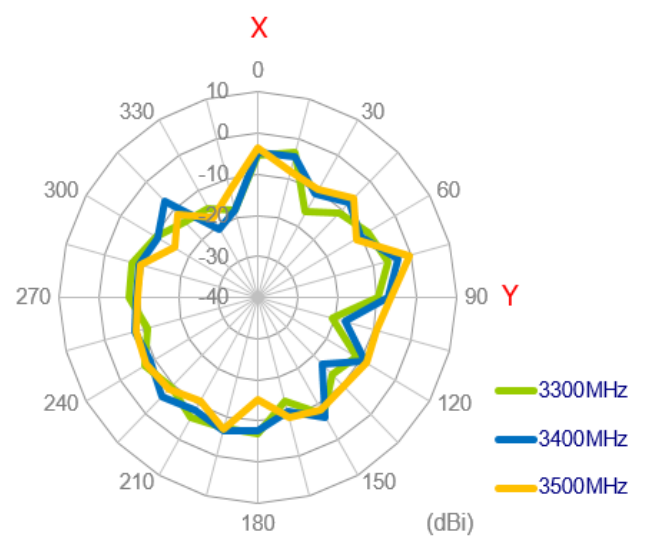
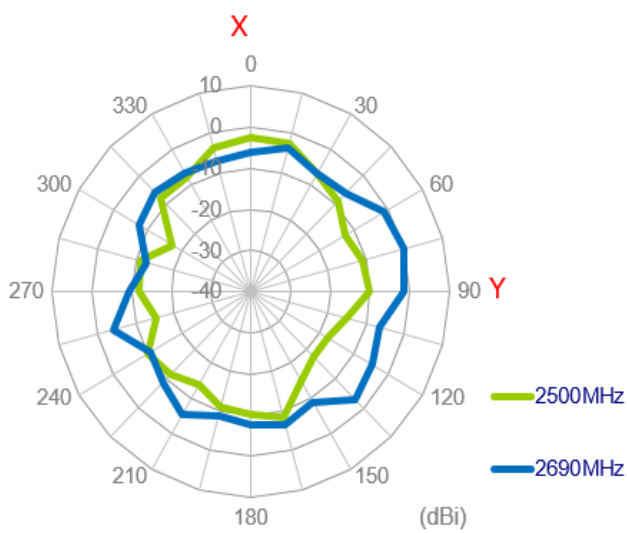
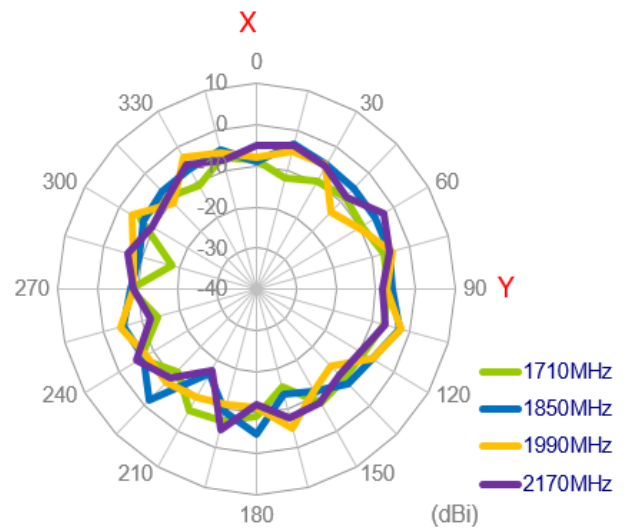
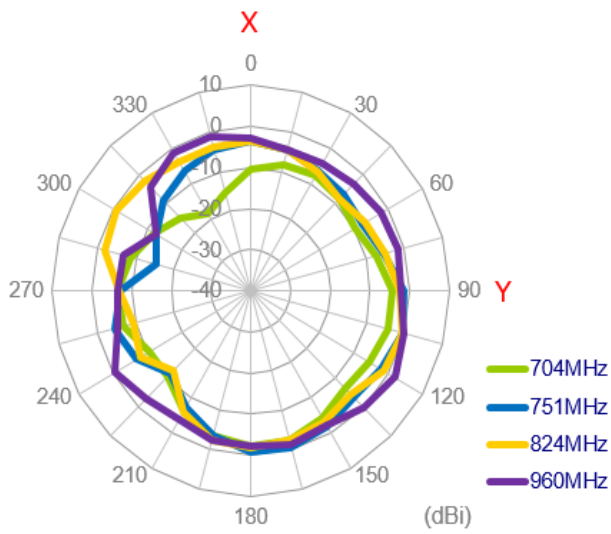

XZ Plane

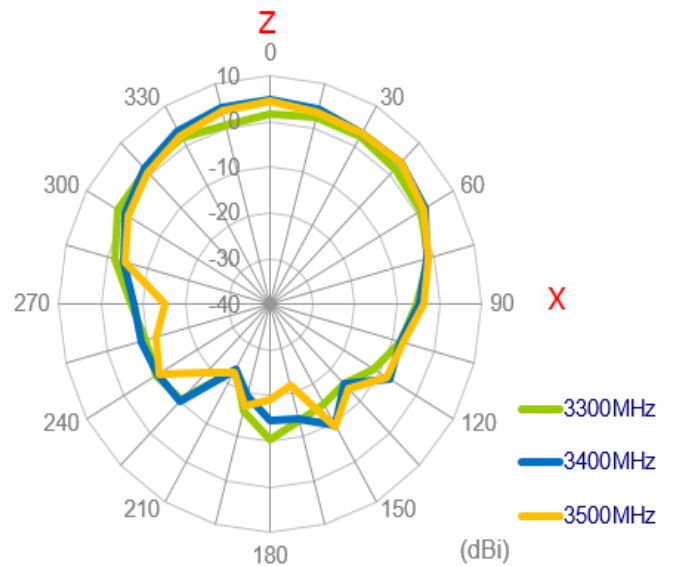
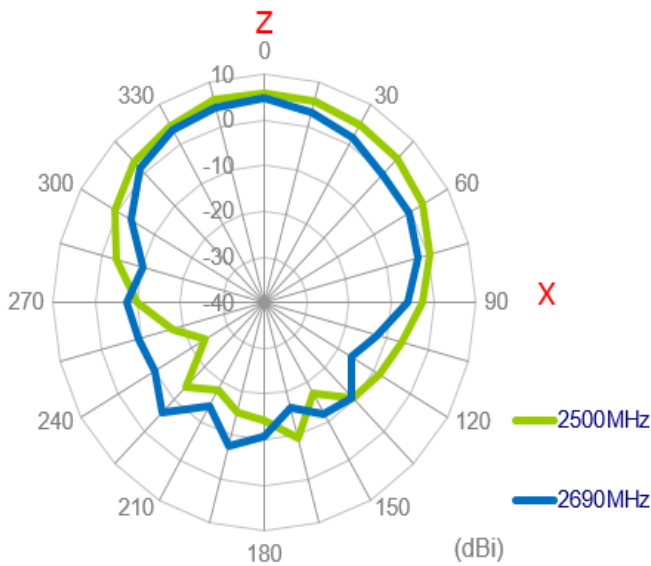
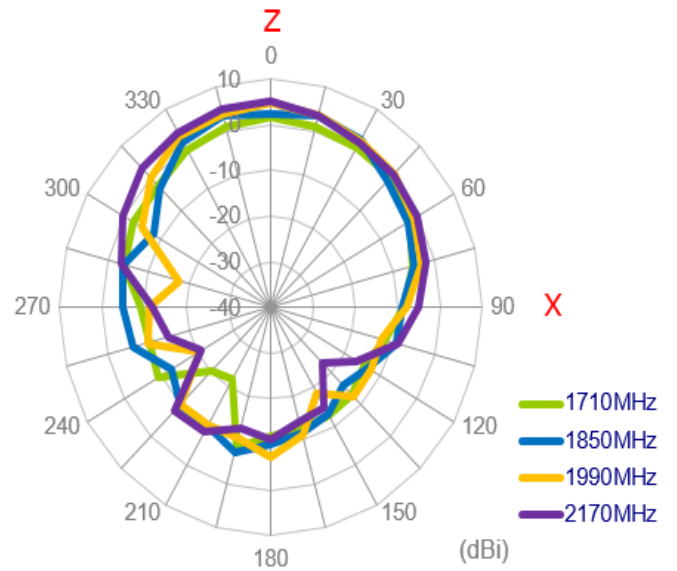
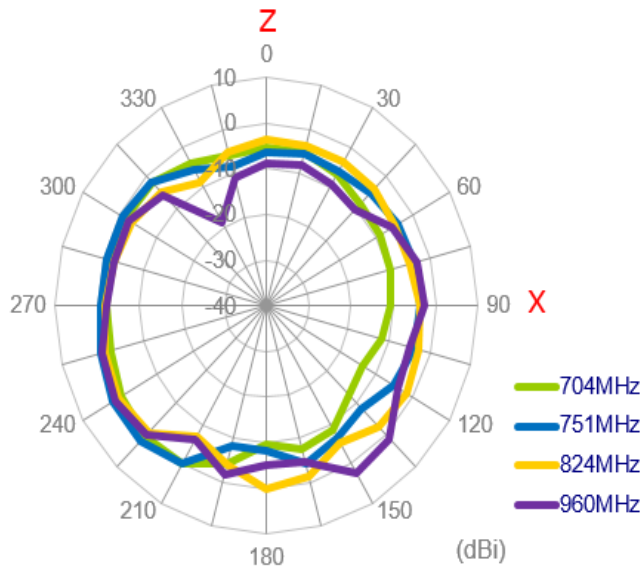

3.2.48. 3D Radiation Pattern (LTE_MIMO1 with 1M cable length on metal)

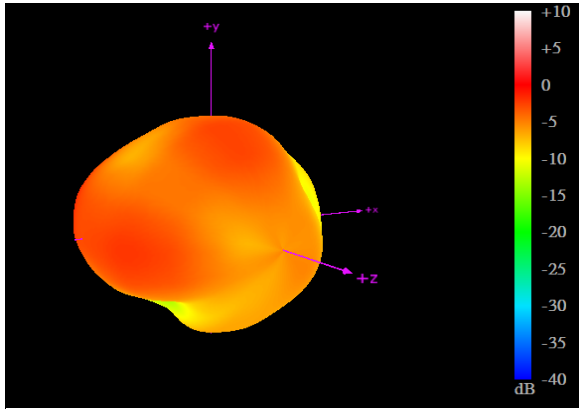

704MHz

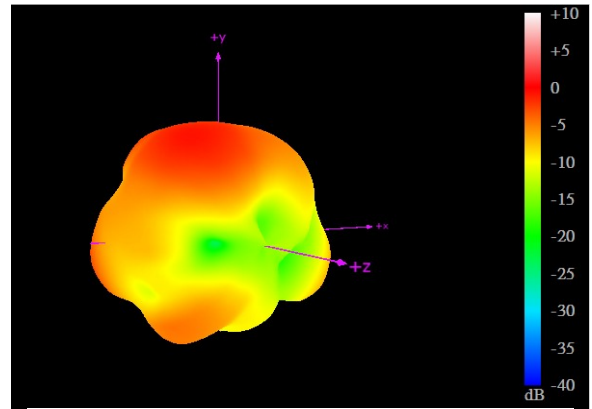

960MHz

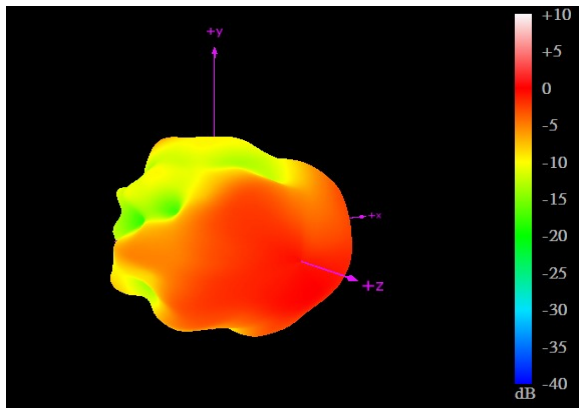

1710MHz

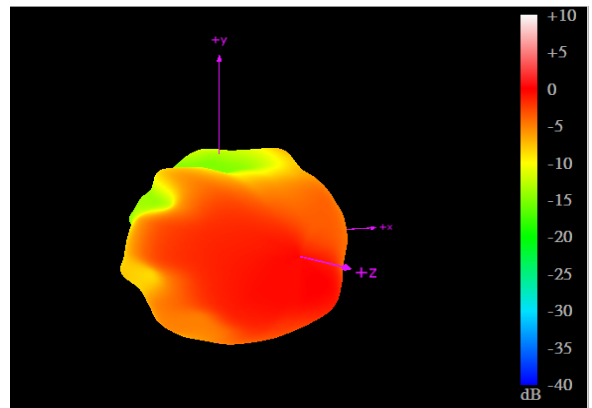

2170MHz

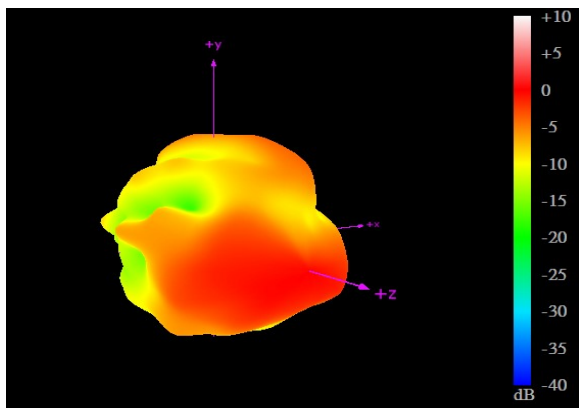

2690MHz

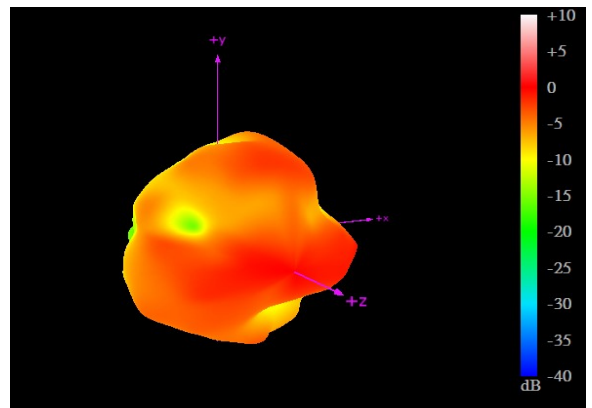

3500MHz

3.2.49. 2D Radiation Pattern (LTE_MIMO2 with 1M cable length on metal) XY Plane

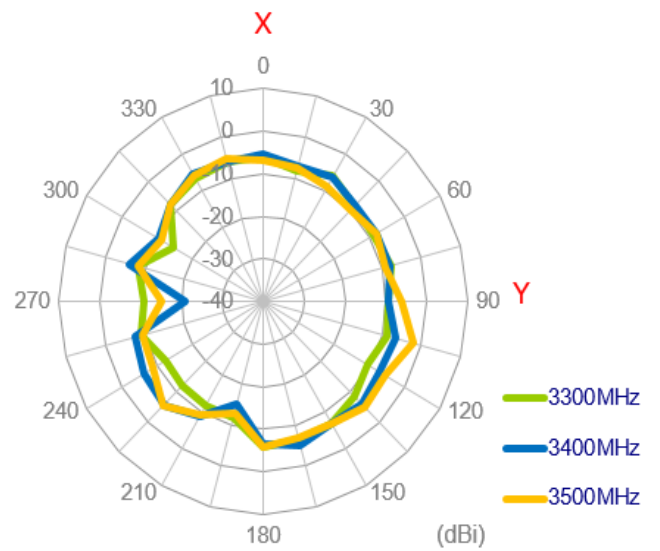
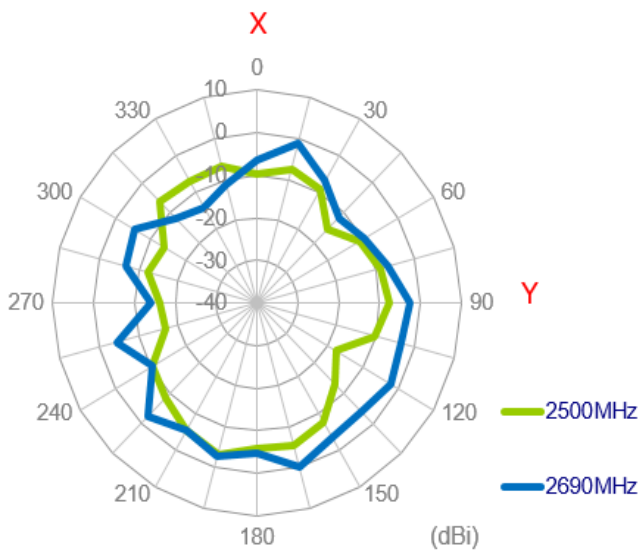
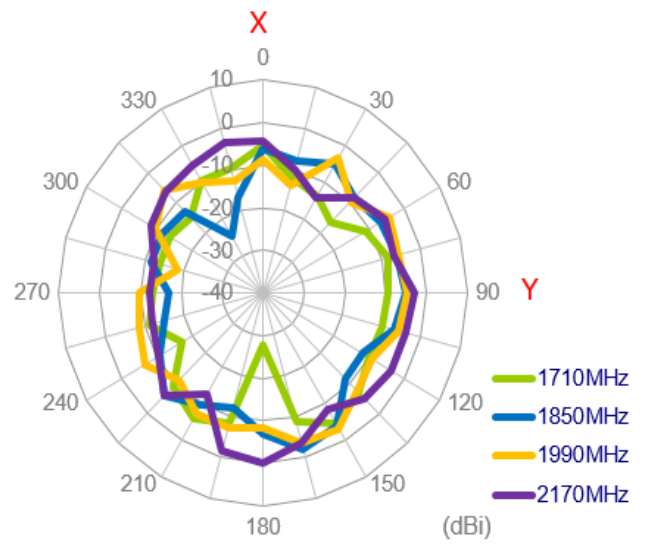
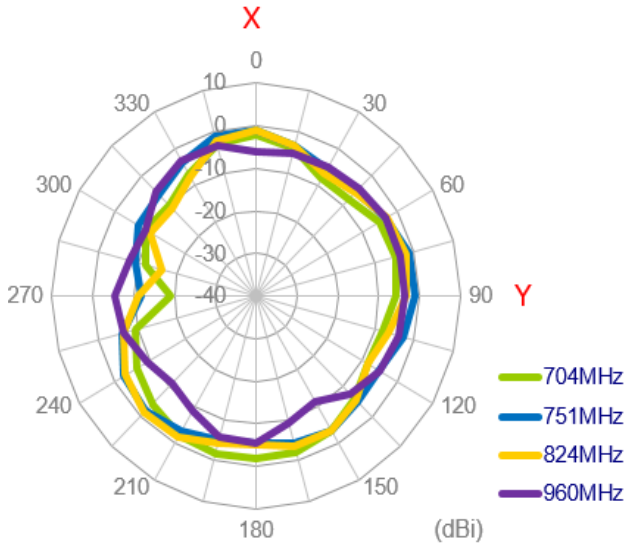

XZ Plane

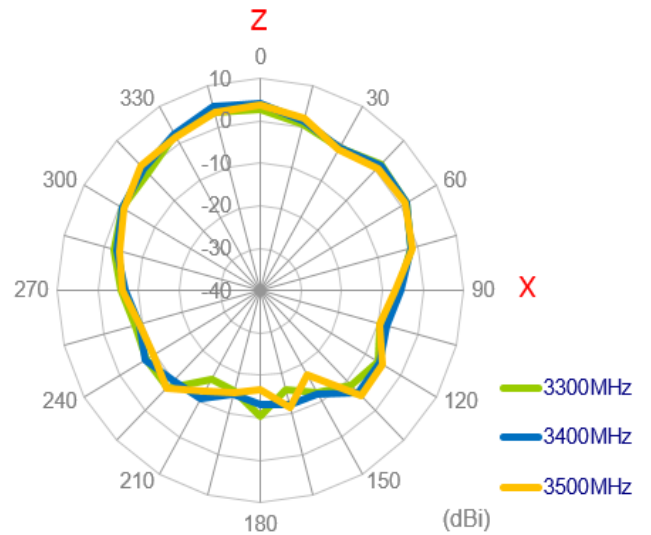
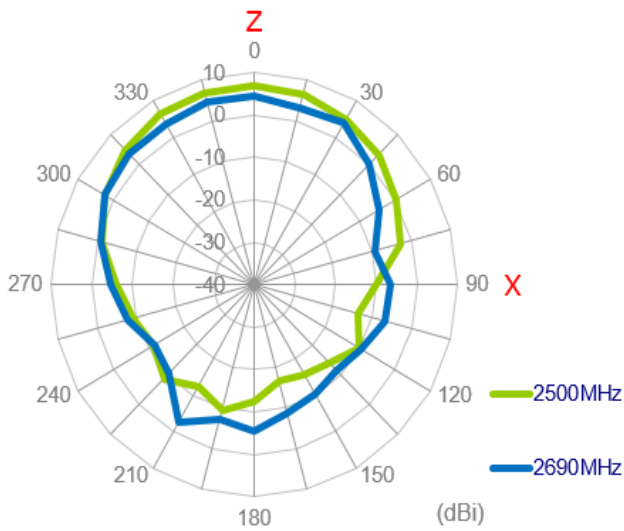
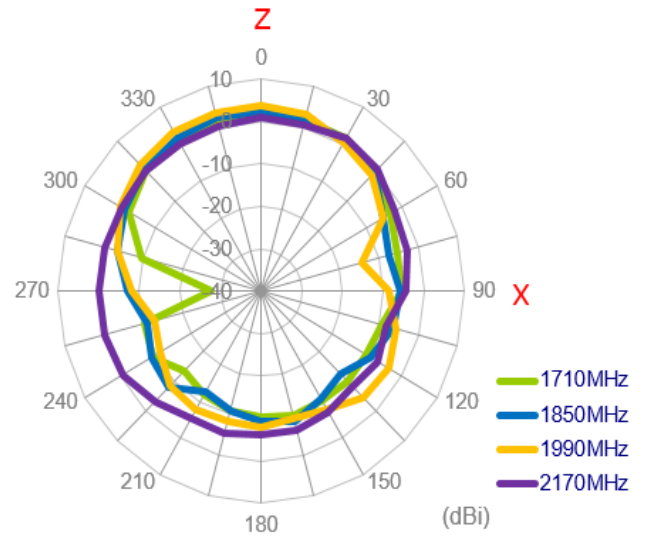
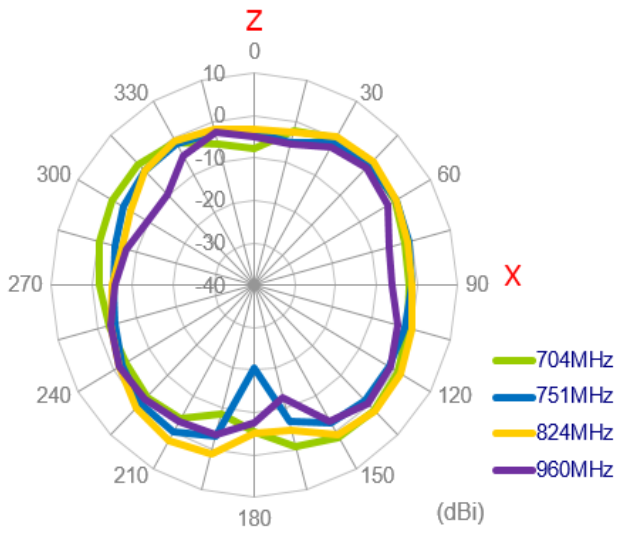

YZ Plane

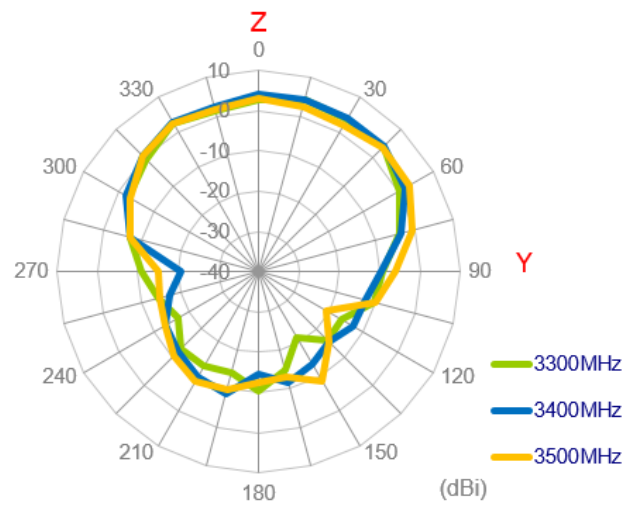
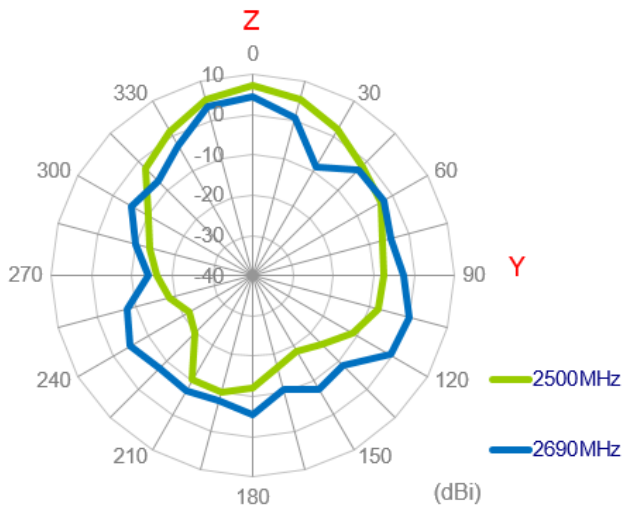
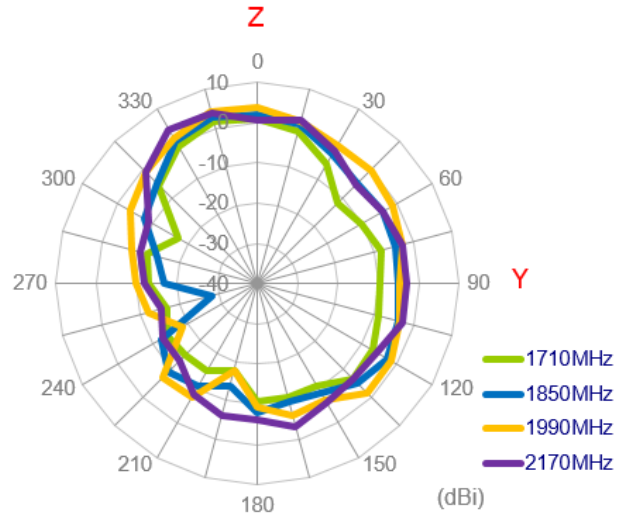
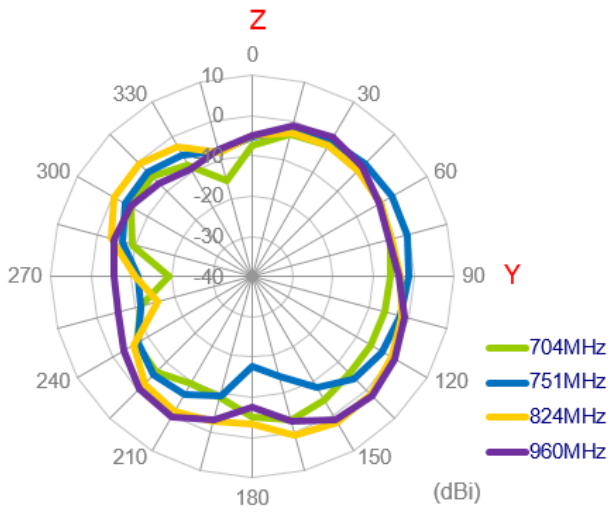

3.2.50. 3D Radiation Pattern (LTE_MIMO2 with 1M cable length on metal)

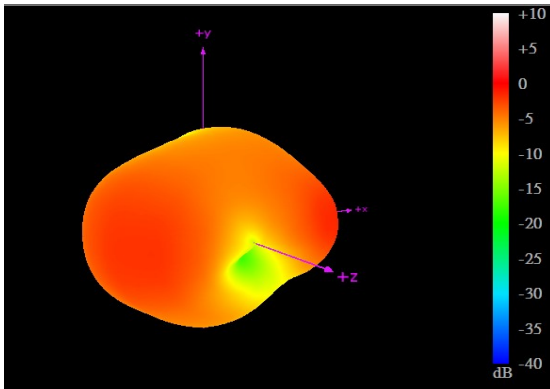

704MHz

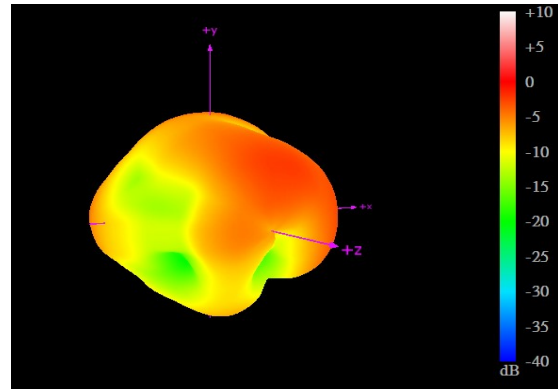

960MHz

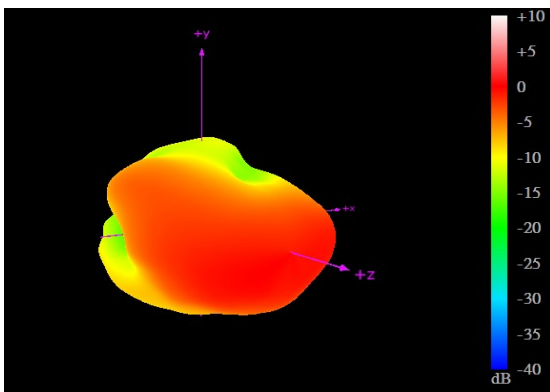

1710MHz

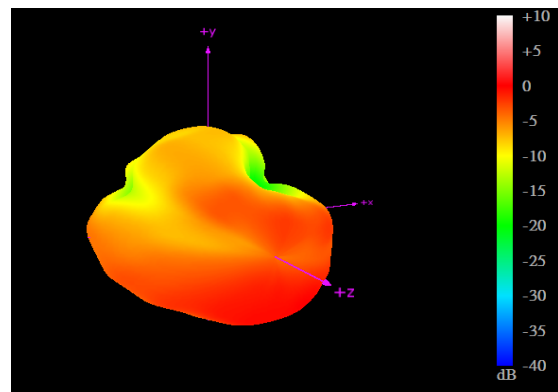

2170MHz

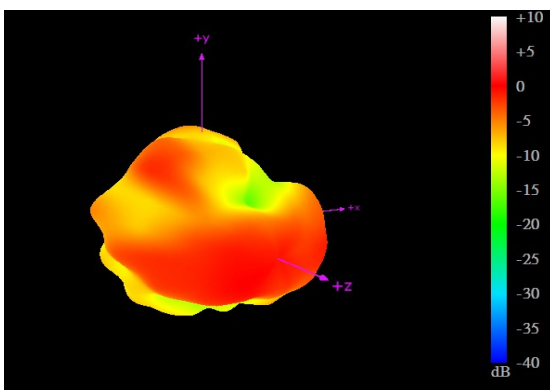

2690MHz

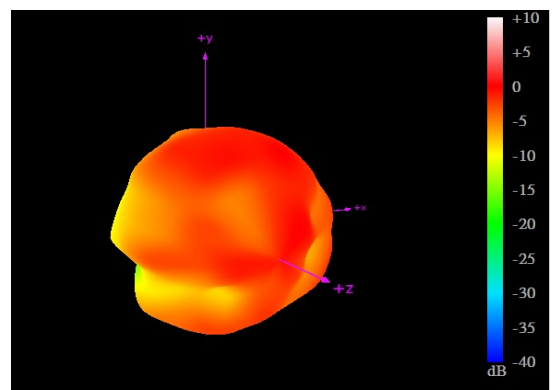

3500MHz

3.2.51. 2D Radiation Pattern (Wi-Fi_MIMO1 with 1M cable length on metal)

XY Plane

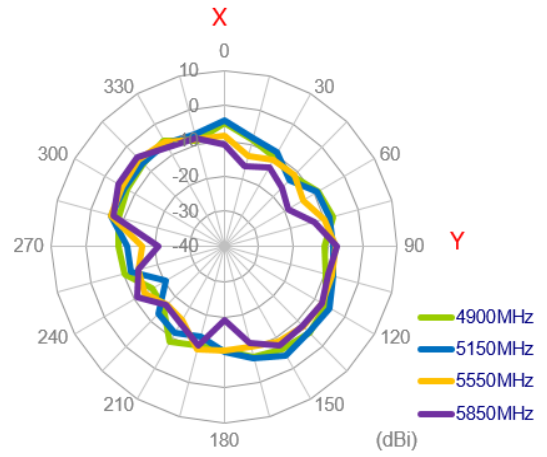
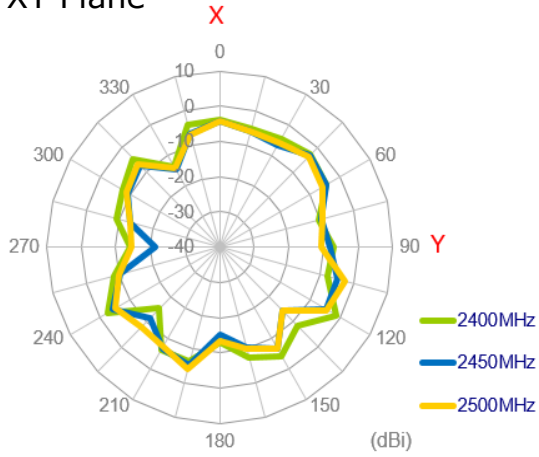

XZ Plane

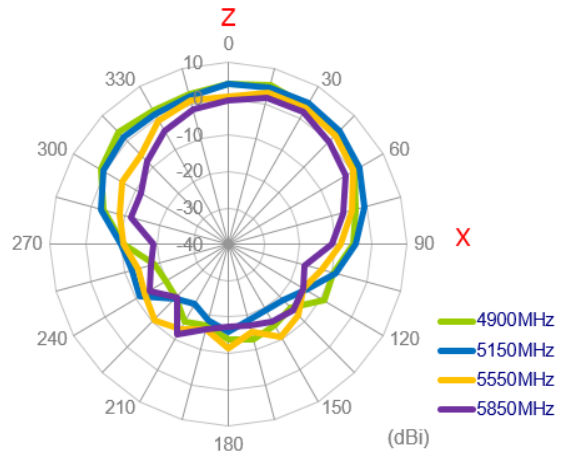
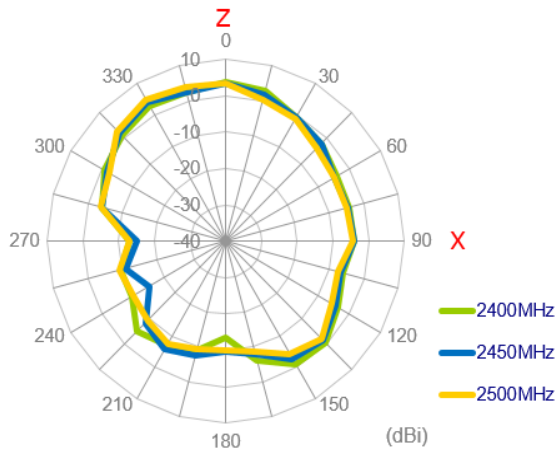

YZ Plane

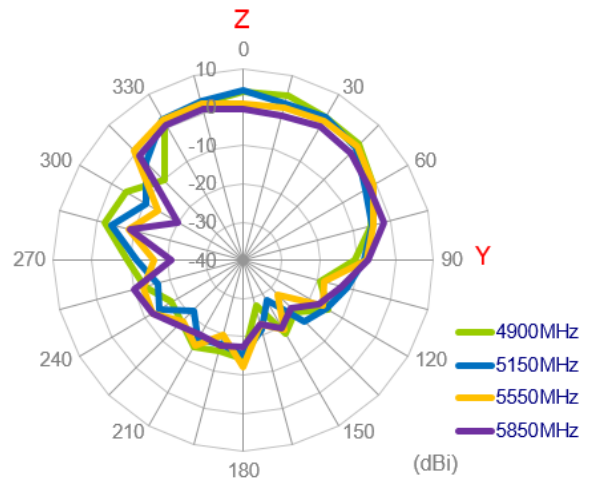
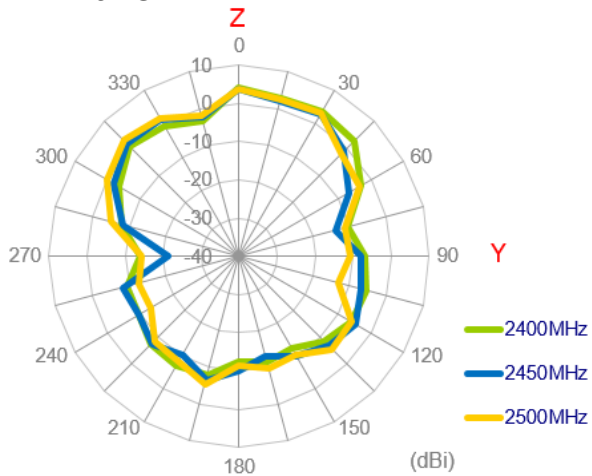

3.2.52. 3D Radiation Pattern (Wi-Fi_MIMO1 with 1M cable length on metal)

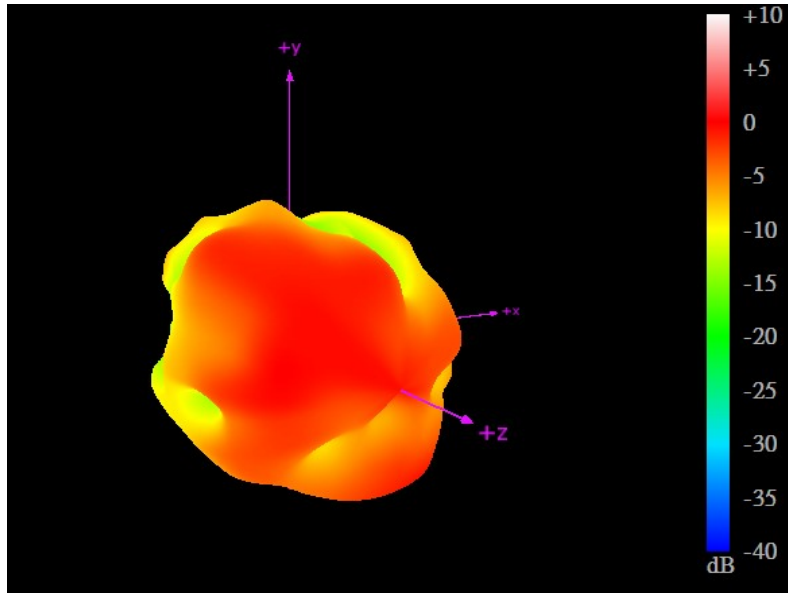

2450MHz

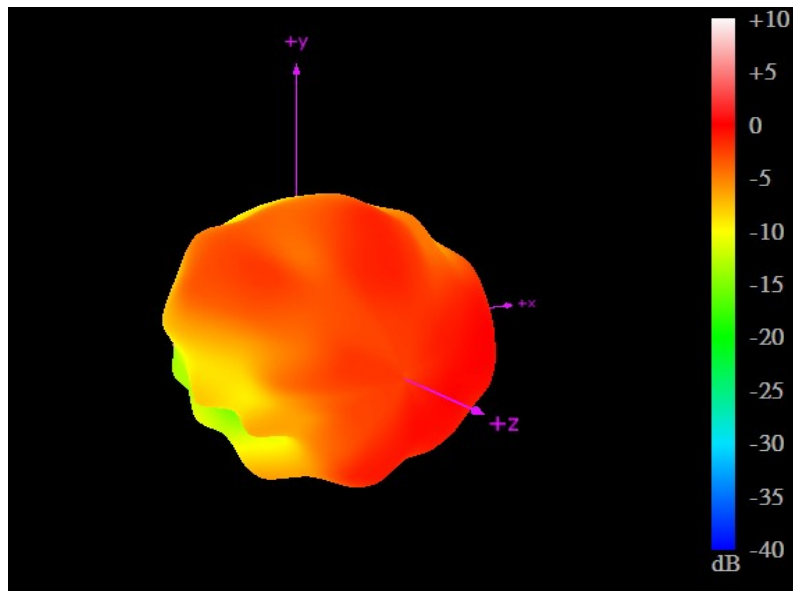

5550MHz

3.2.53. 2D Radiation Pattern (Wi-Fi_MIMO2 with 3M cable length on metal)

XY Plane

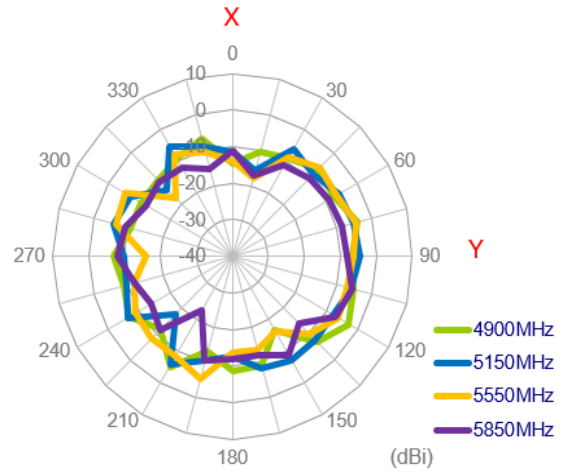
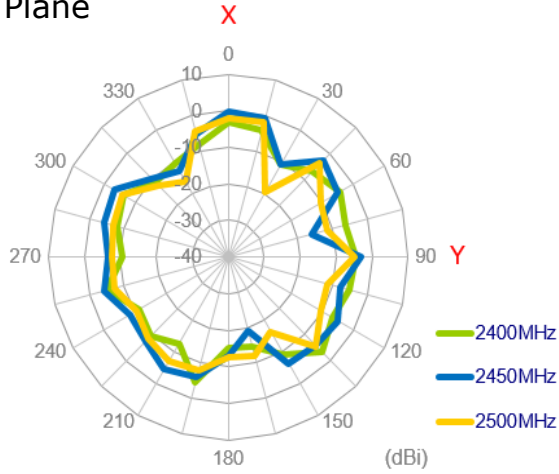

XZ Plane

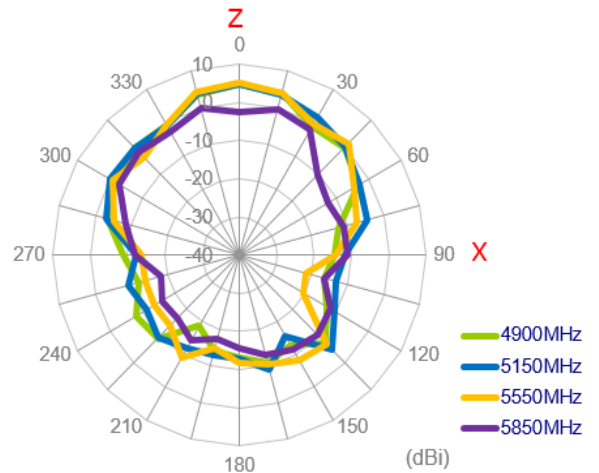
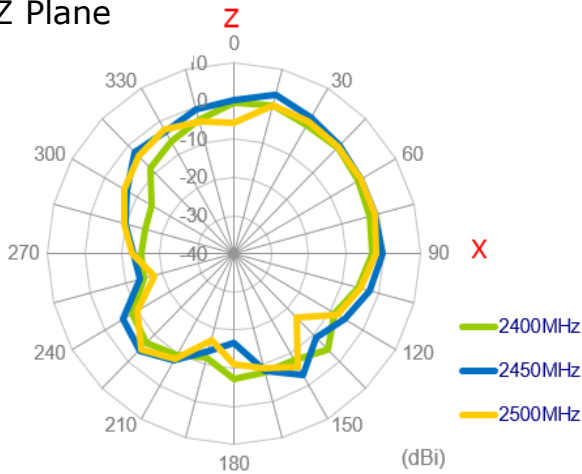

YZ Plane

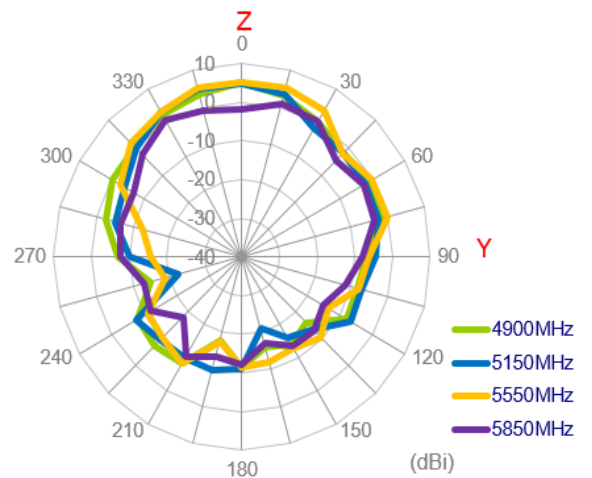
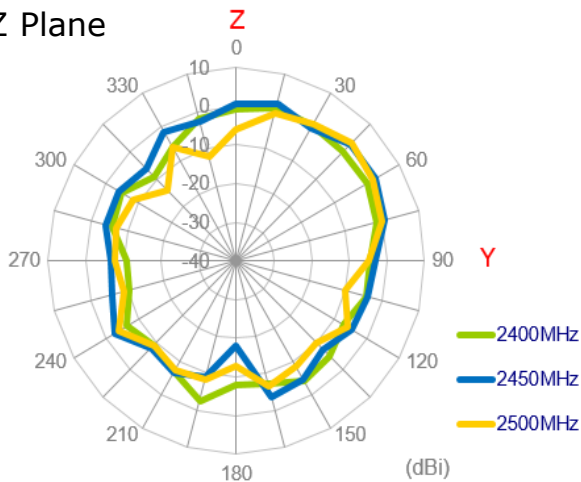

3.2.54. 3D Radiation Pattern (Wi-Fi_MIMO2 with 1M cable length on metal)

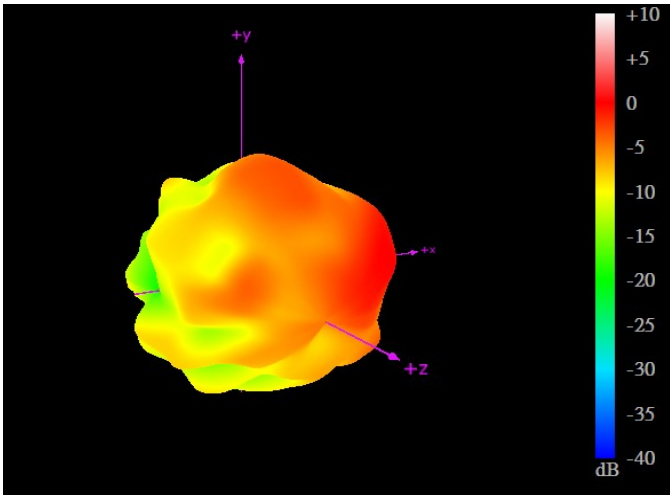

2450MHz

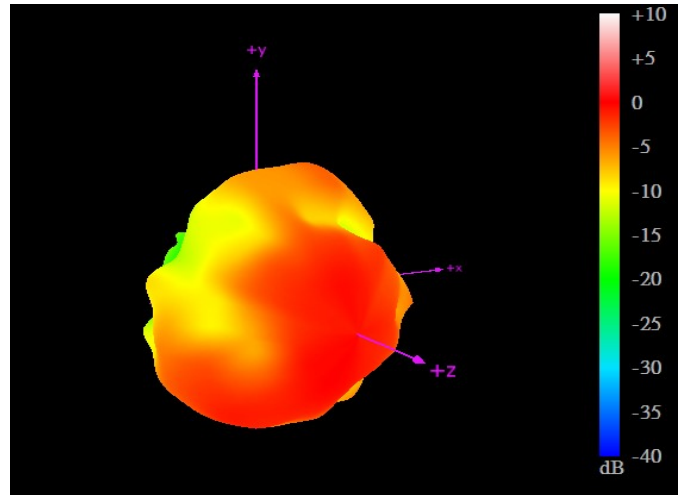

5550MHz

3.2.55. Test Setup for Antenna Radiation Pattern

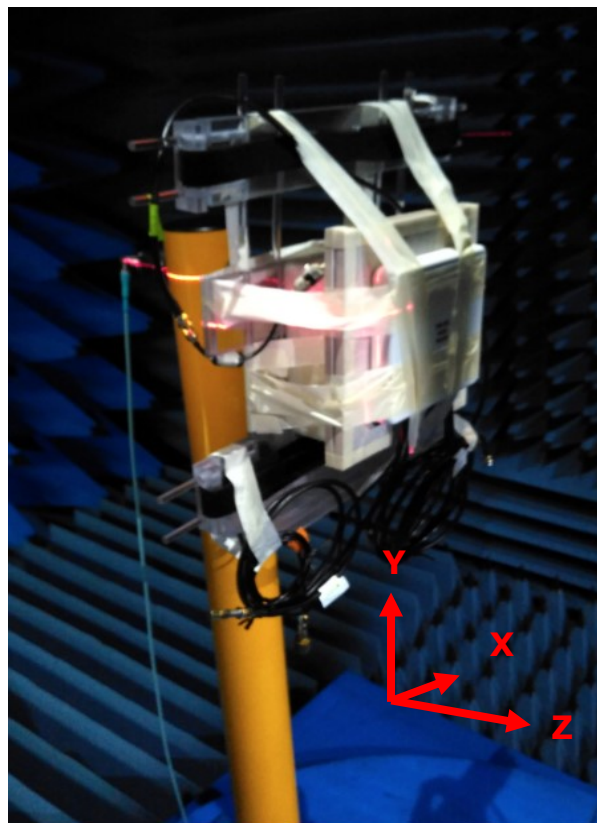

On the Wall

3.2.56. 2D Radiation Pattern (LTE_MIMO1 with 1M cable length on the wall)

XY Plane

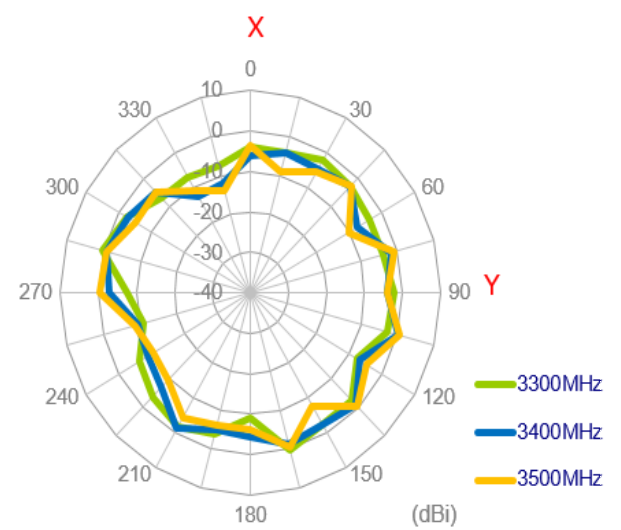
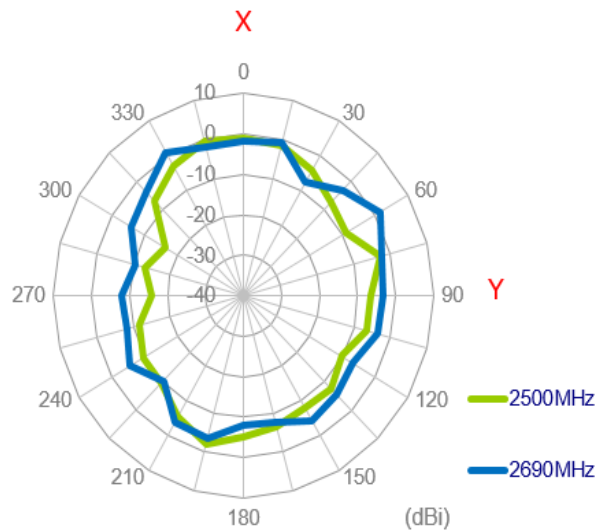
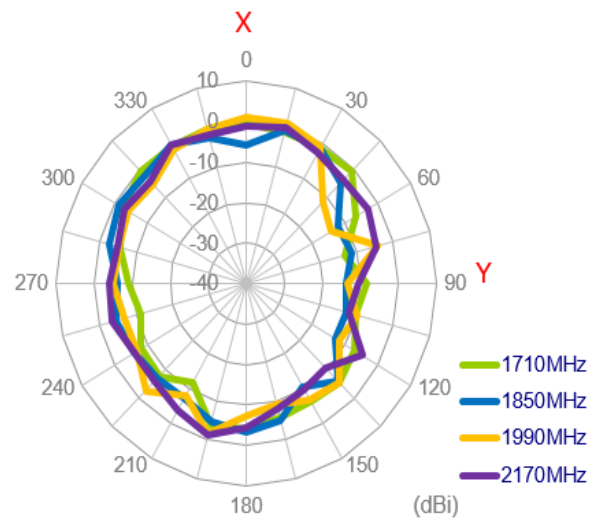
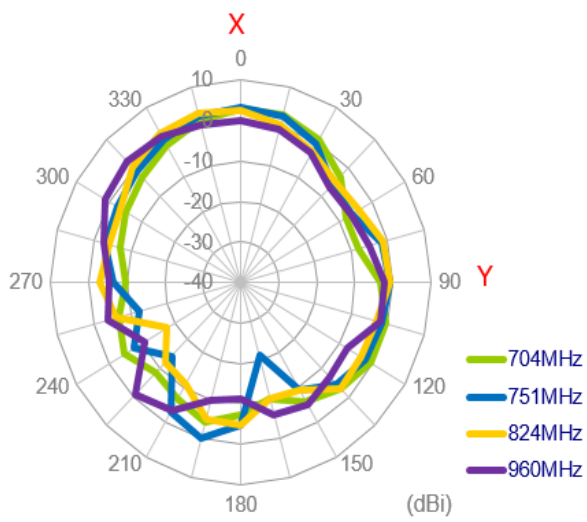

XZ Plane

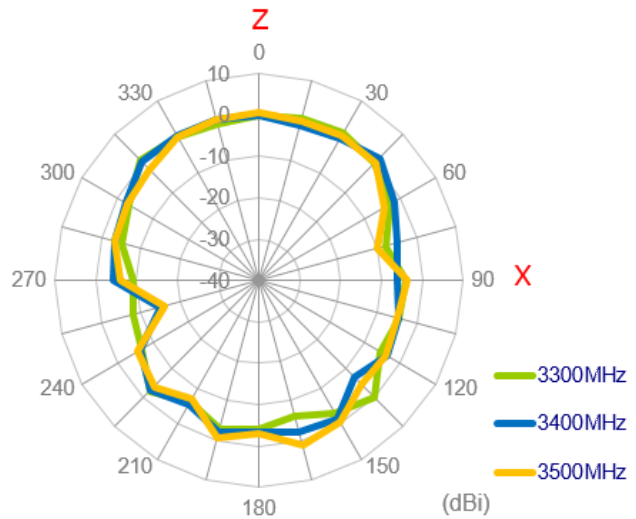
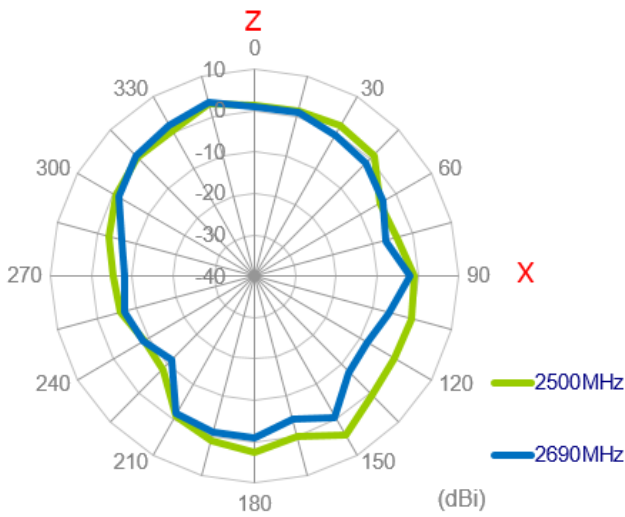
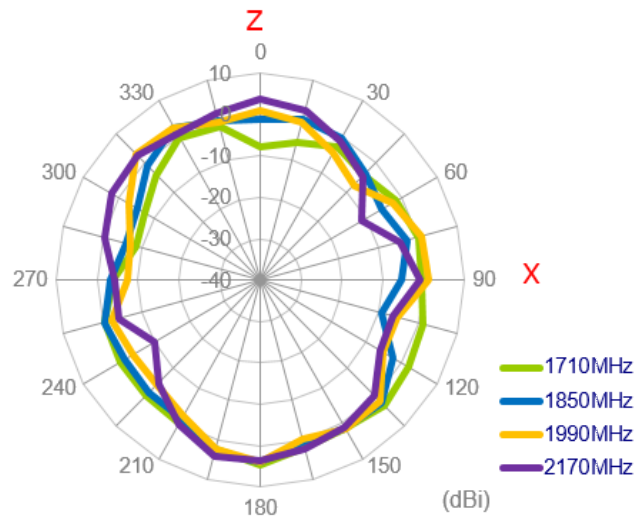
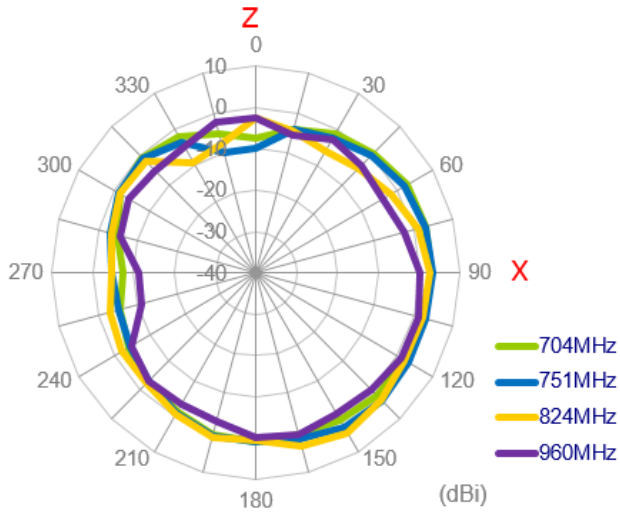

YZ Plane

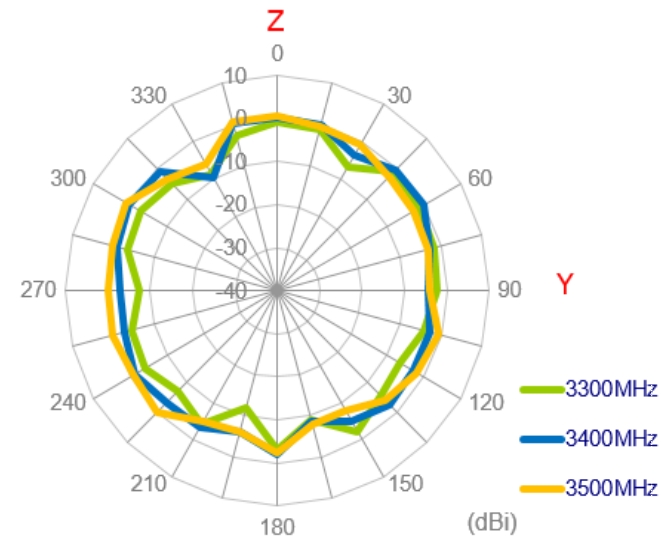
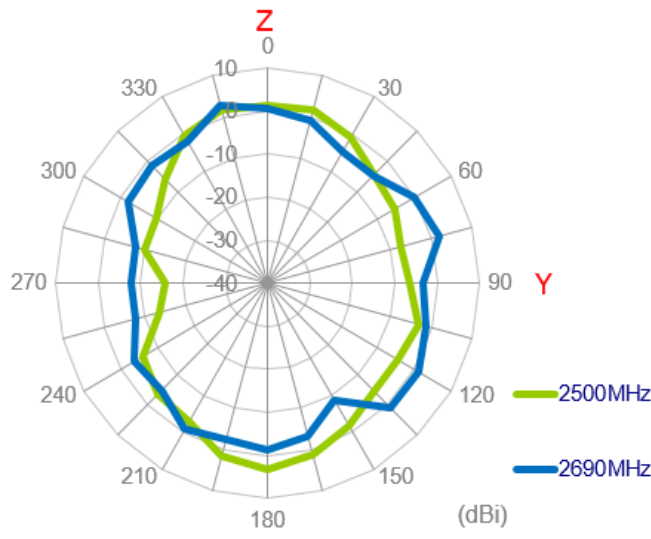
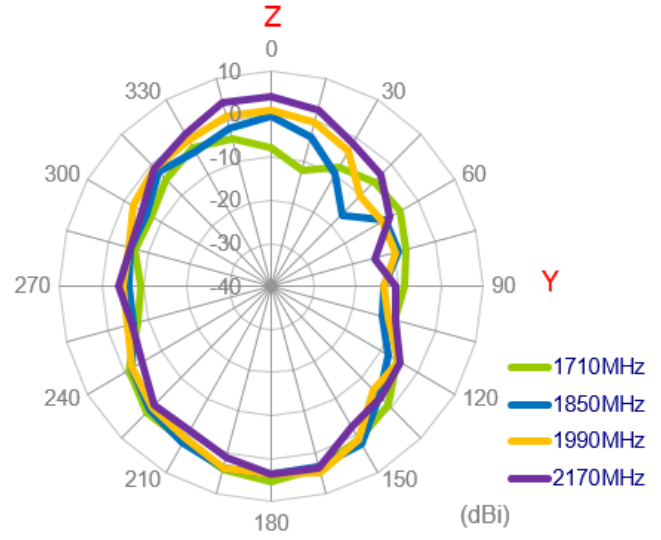
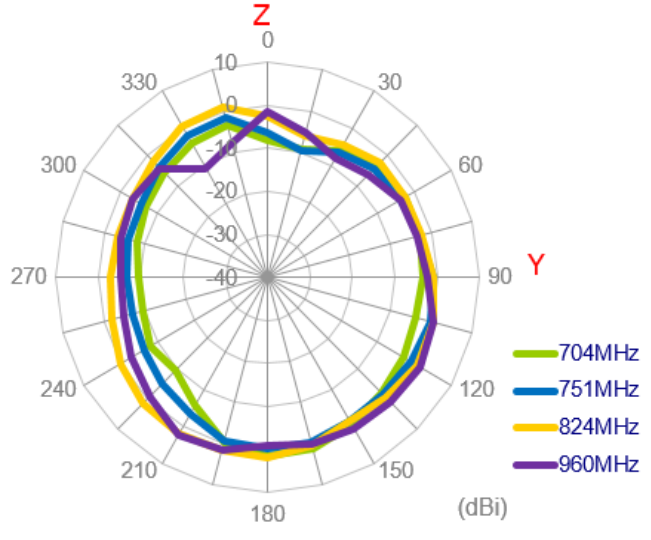

3.2.57. 3D Radiation Pattern (LTE_MIMO1 with 1M cable length on the wall)

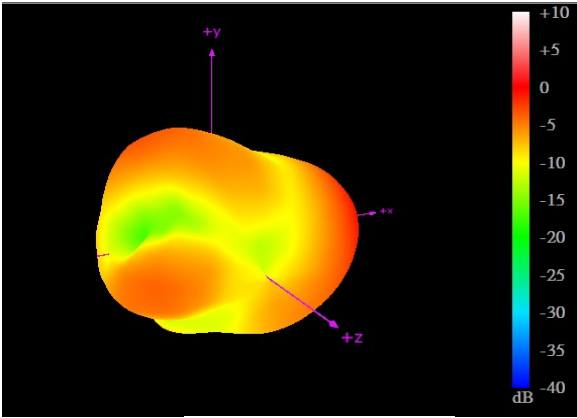

704MHz

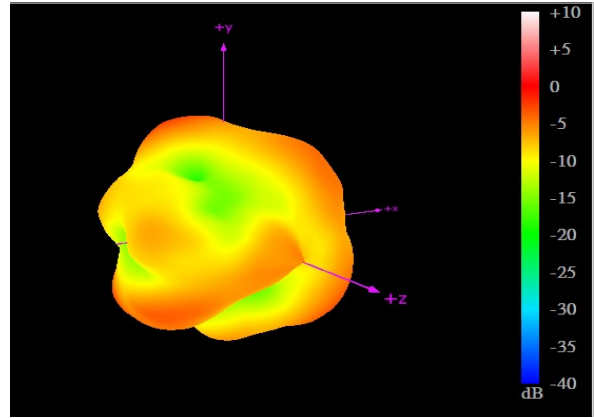

960MHz

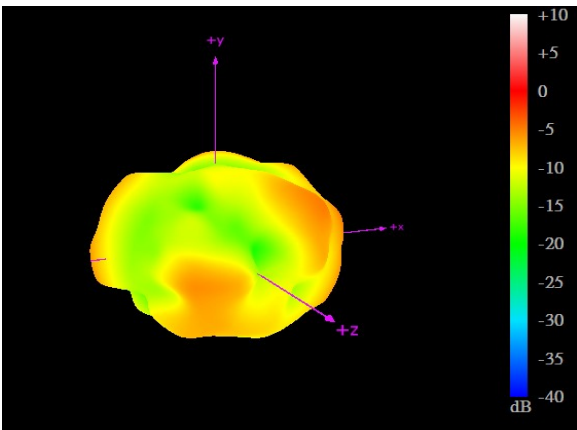

1710MHz

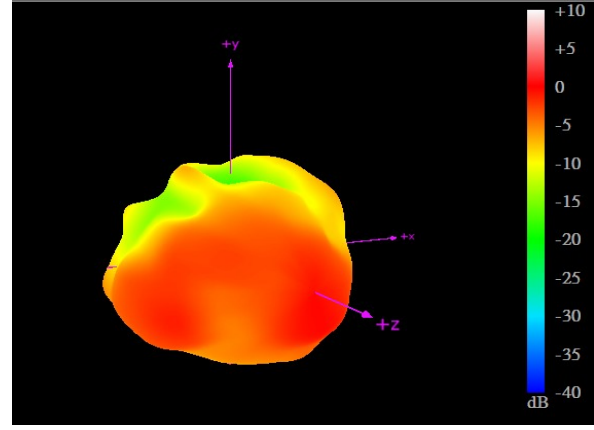

2170MHz

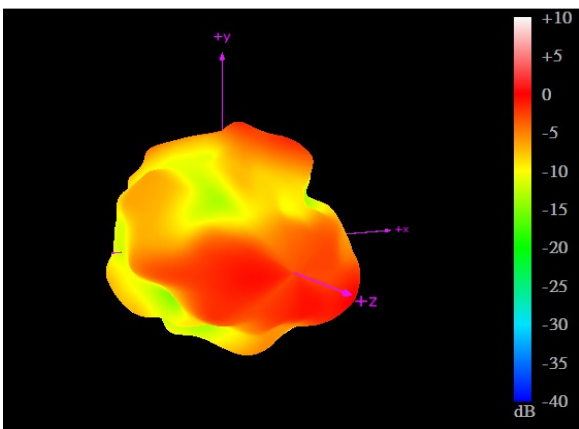

2690MHz

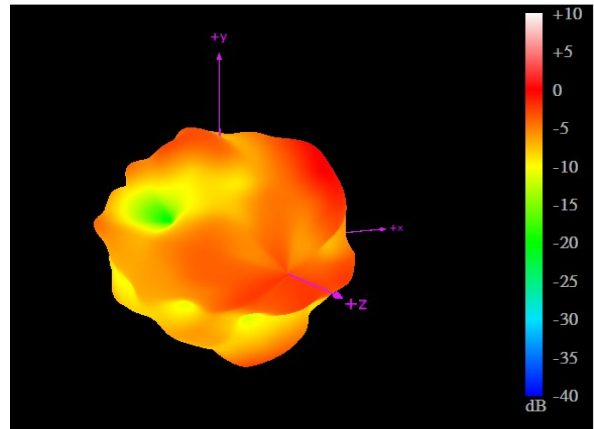

3500MHz

3.2.58. 2D Radiation Pattern (LTE_MIMO2 with 1M cable length on the wall)

XY Plane

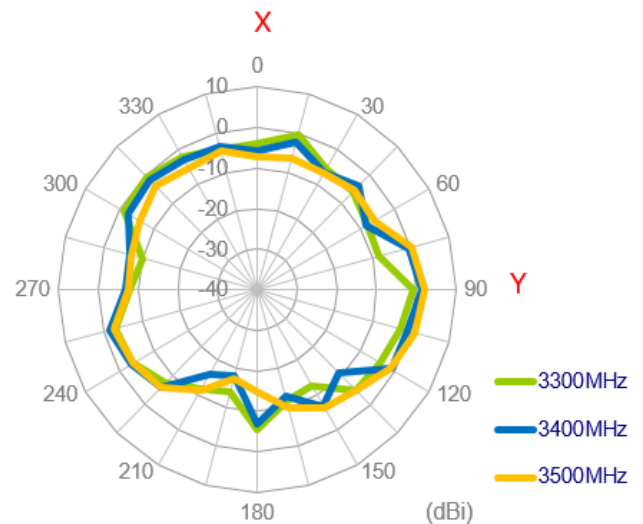
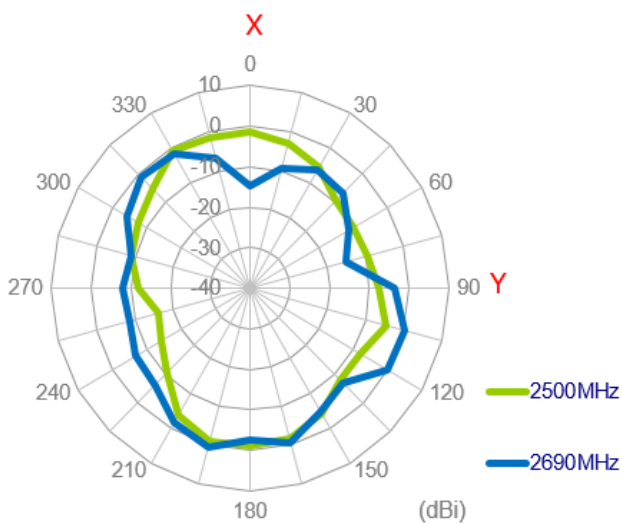
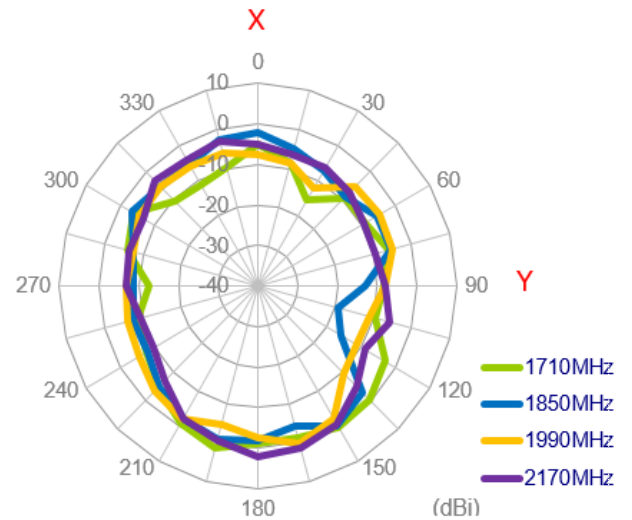
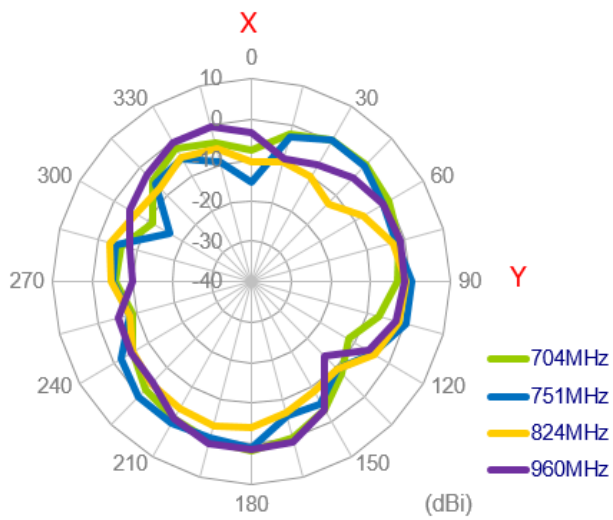

XZ Plane

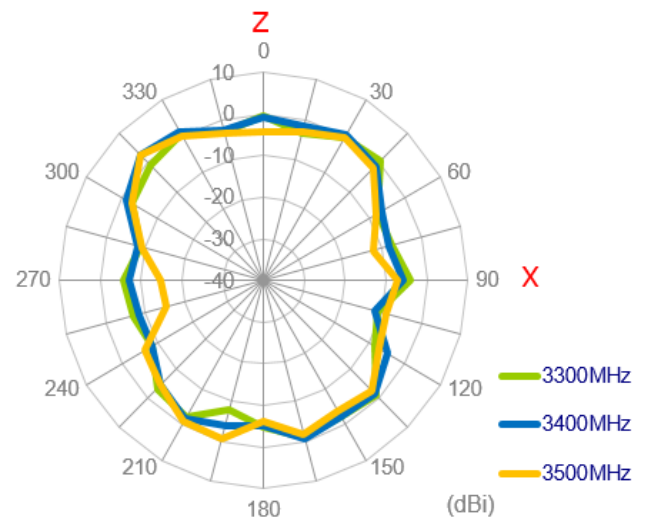
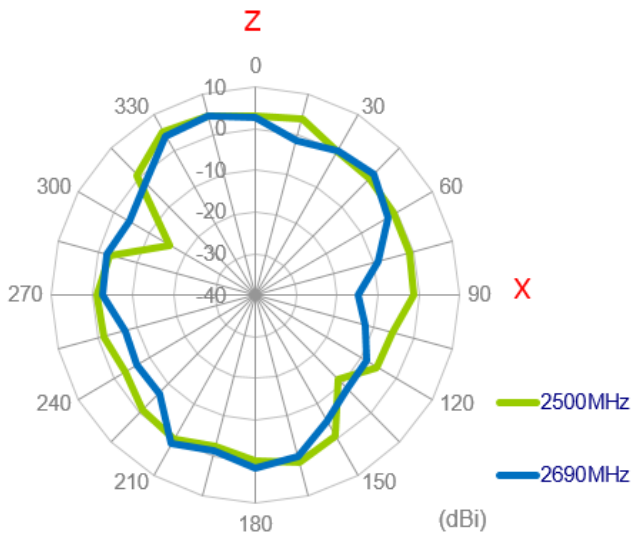
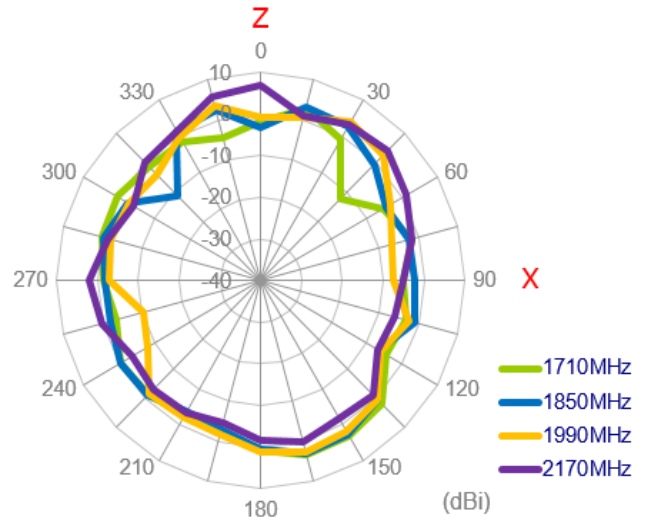
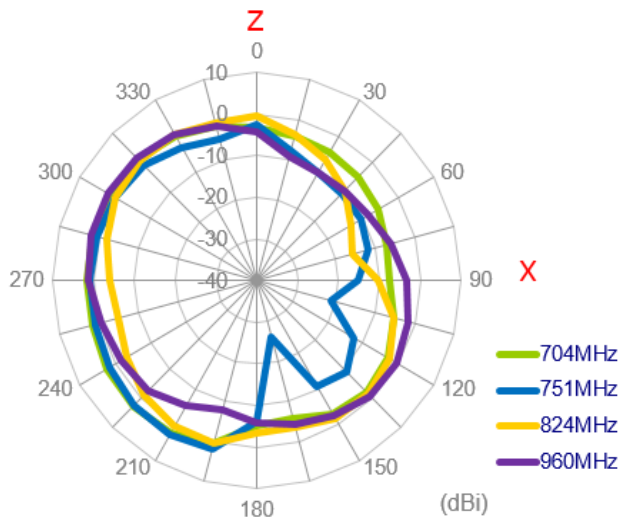

YZ Plane

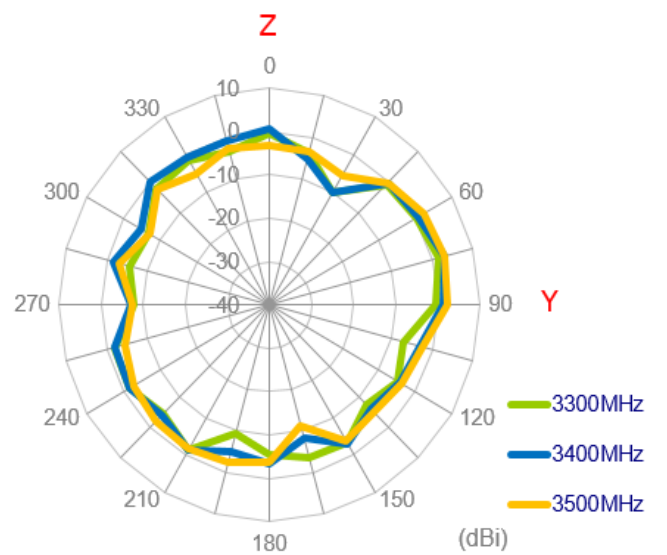
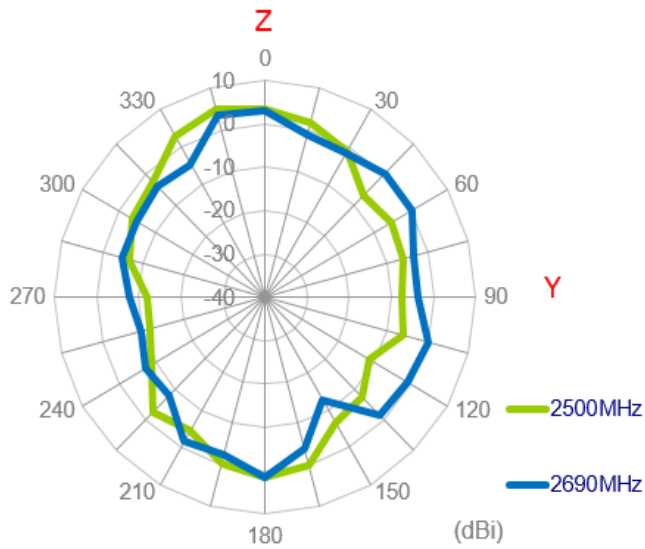
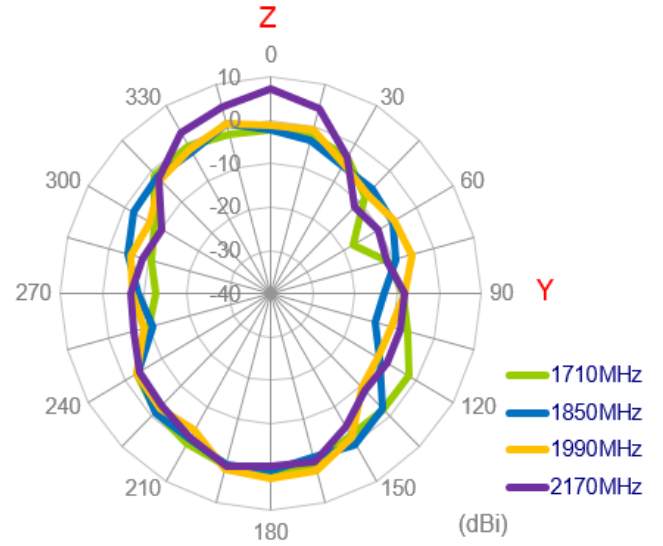
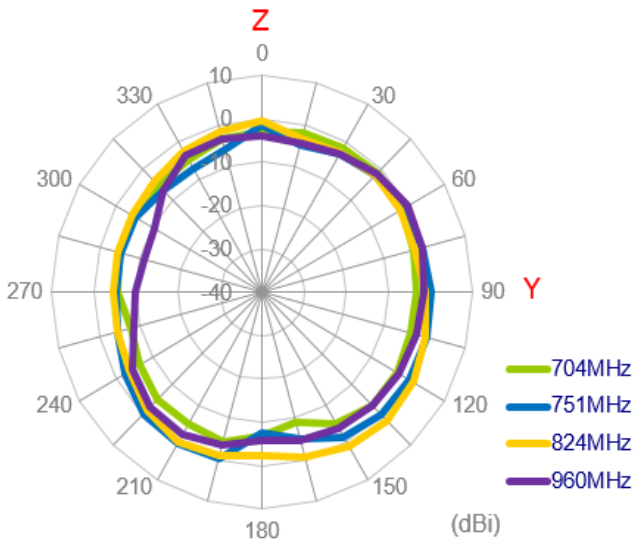

3.2.59. 3D Radiation Pattern (LTE_MIMO2 with 1M cable length on the wall)

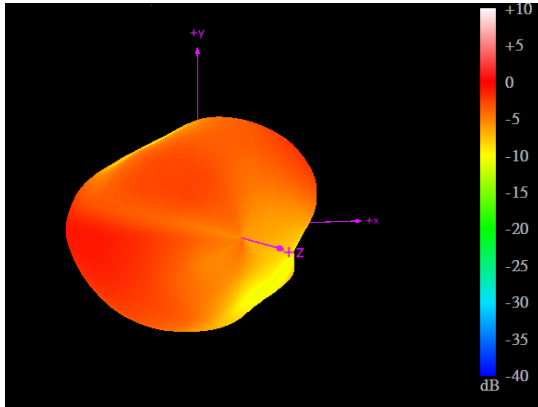

704MHz

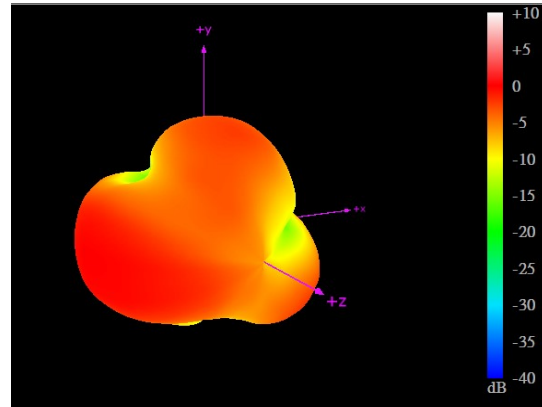

960MHz

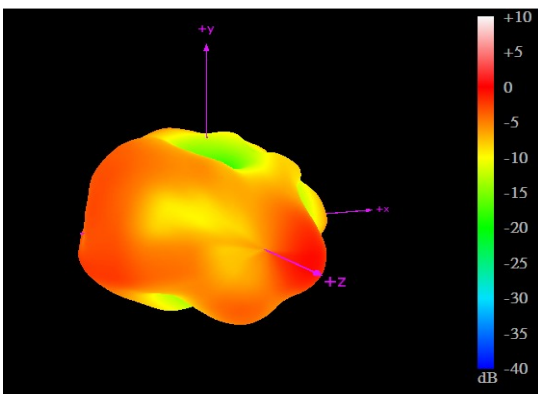

1710MHz

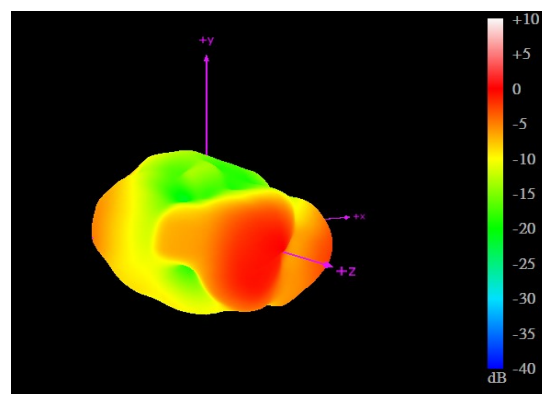

2170MHz

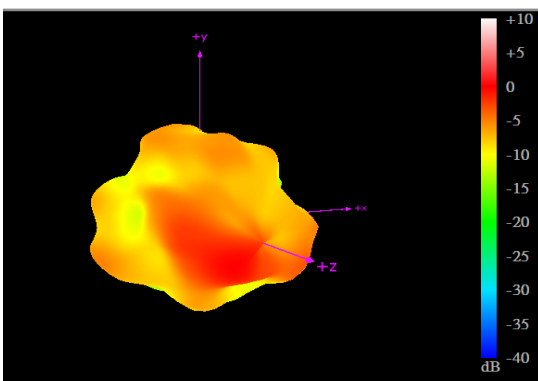

2690MHz

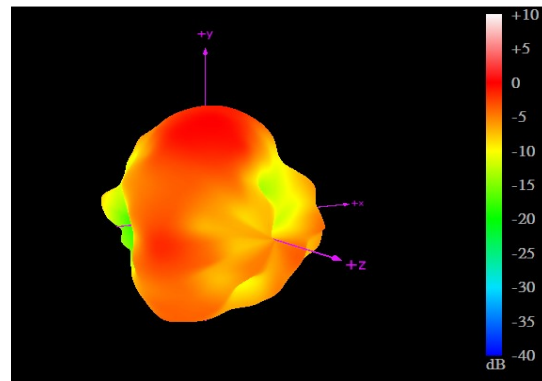

3500MHz

3.2.60. 2D Radiation Pattern (Wi-Fi_MIMO1 with 1M cable length in free space)

XY Plane

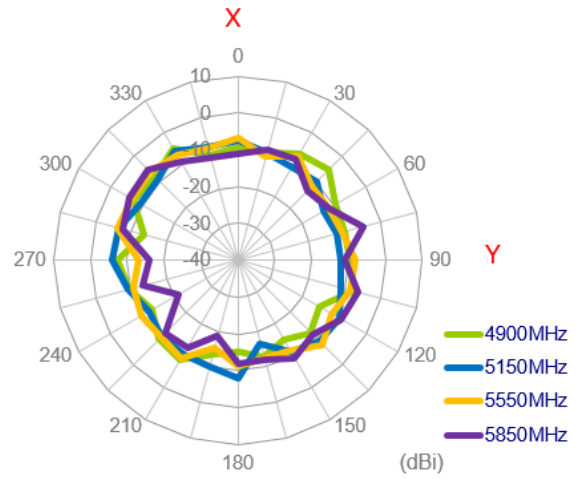
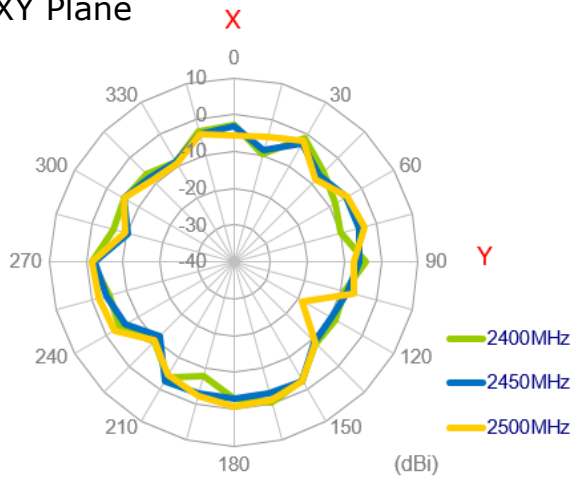

XZ Plane

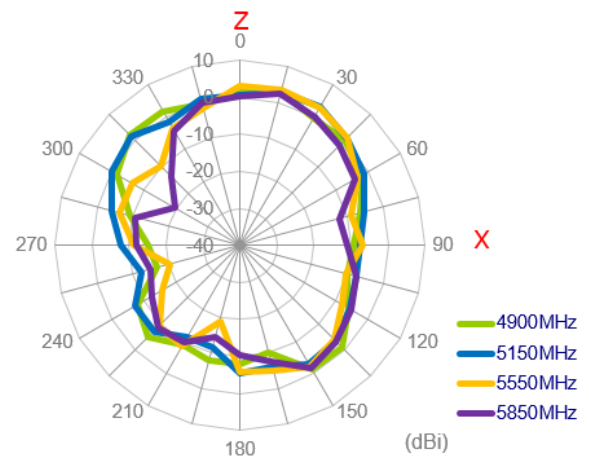
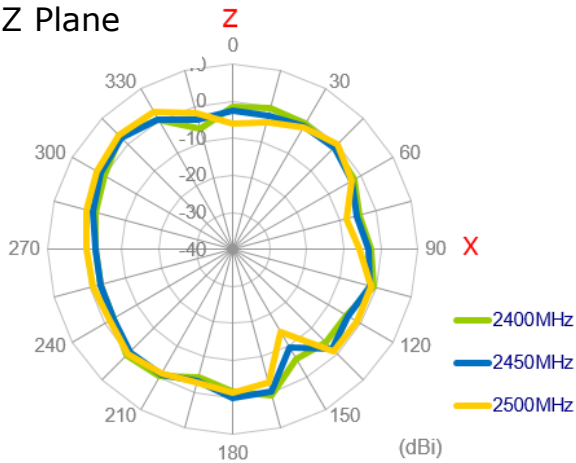

YZ Plane

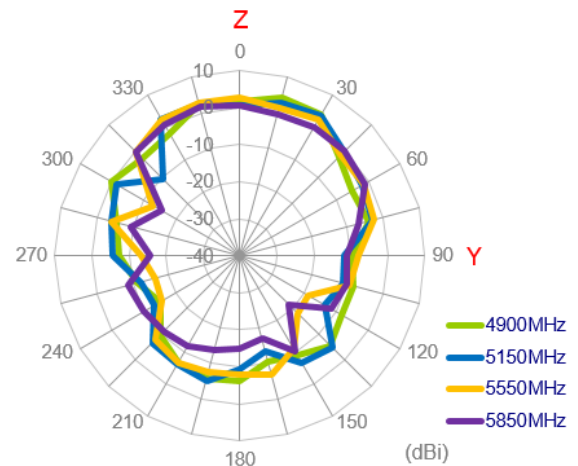
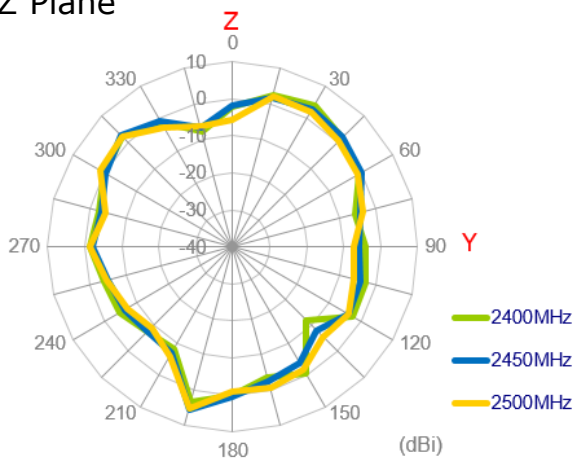

3.2.61 3D Radiation Pattern (Wi-Fi_MIMO1 with 1M cable length in free space)

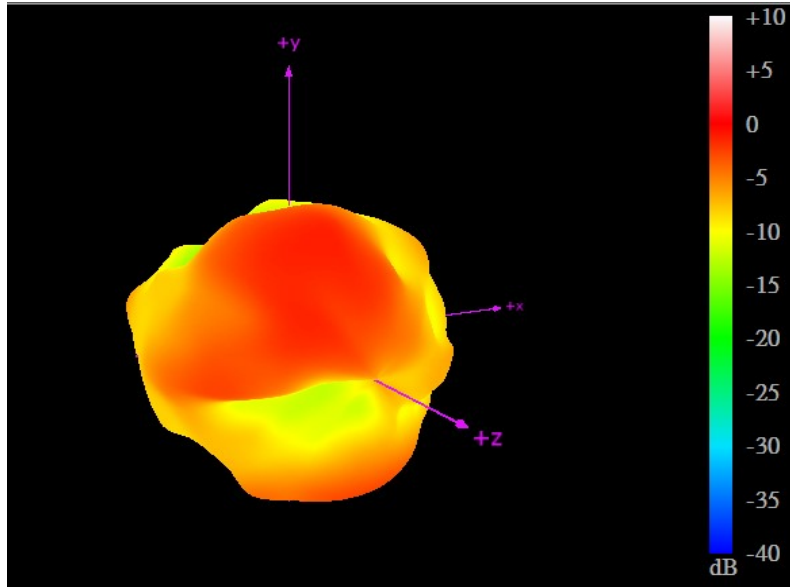

2450MHz

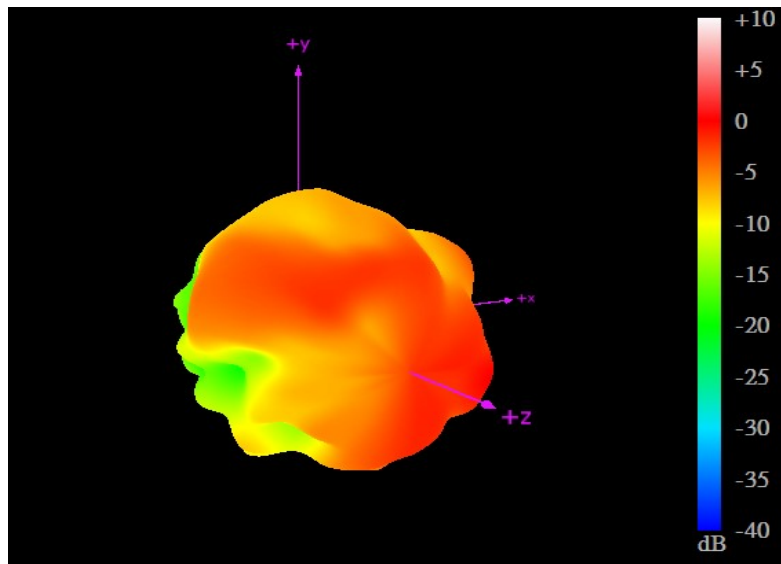

5550MHz

3.2.61. 2D Radiation Pattern (Wi-Fi_MIMO2 with 3M cable length in free space)

XY Plane

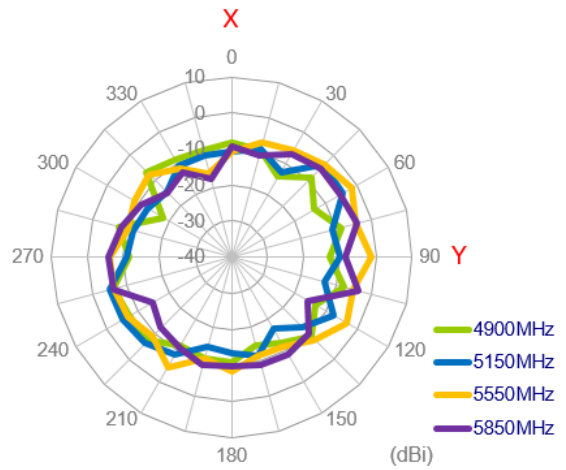
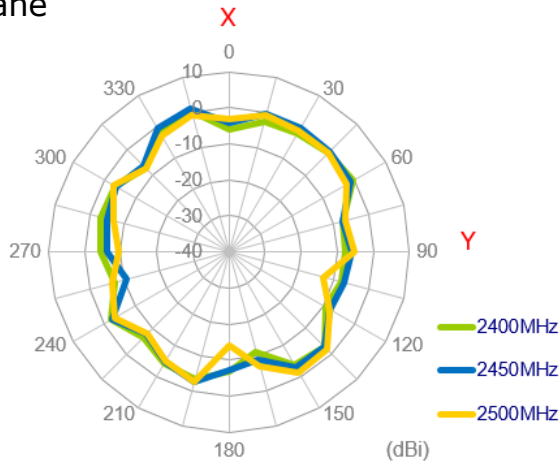

XZ Plane

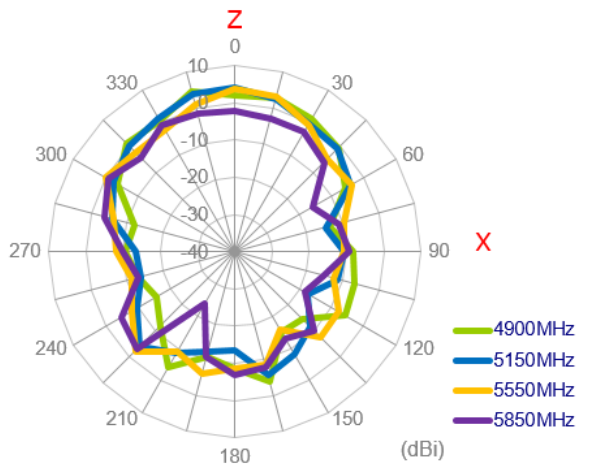
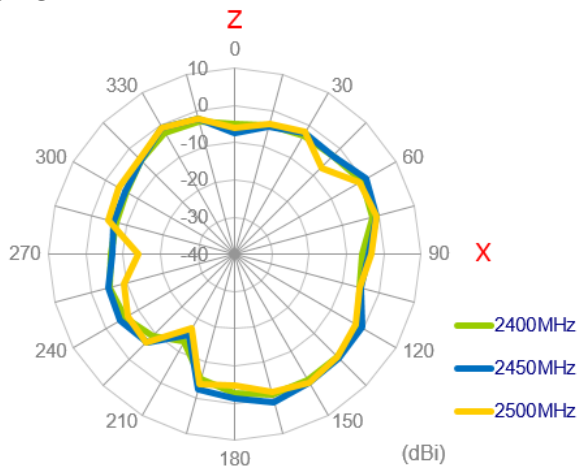

YZ Plane

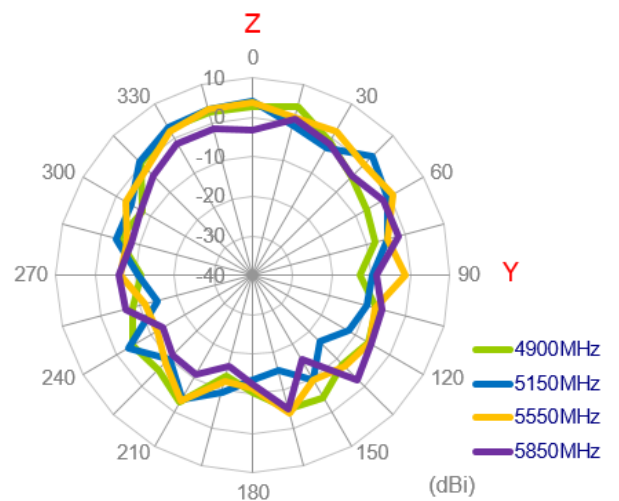
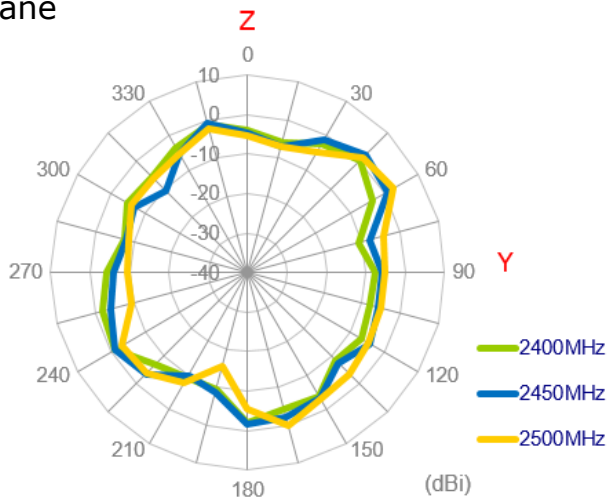

3.2.62. 3D Radiation Pattern (Wi-Fi_MIMO2 with 1M cable length in free space)

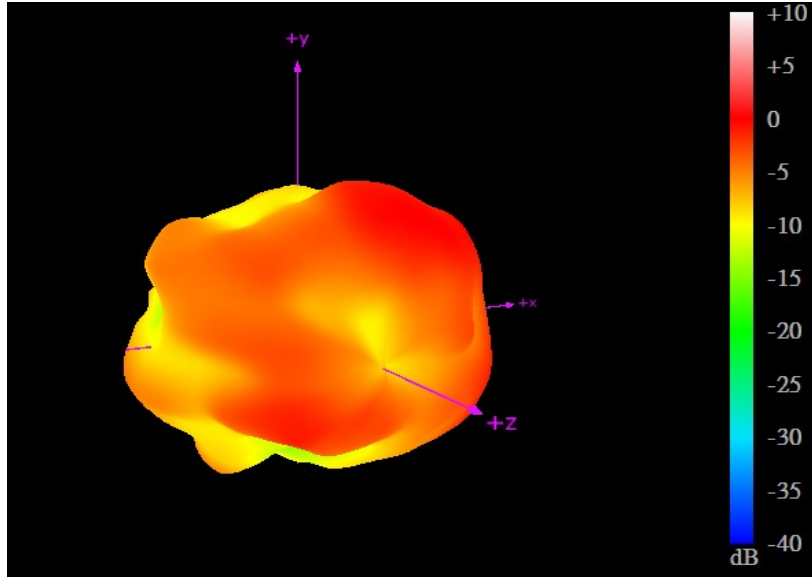

2450MHz

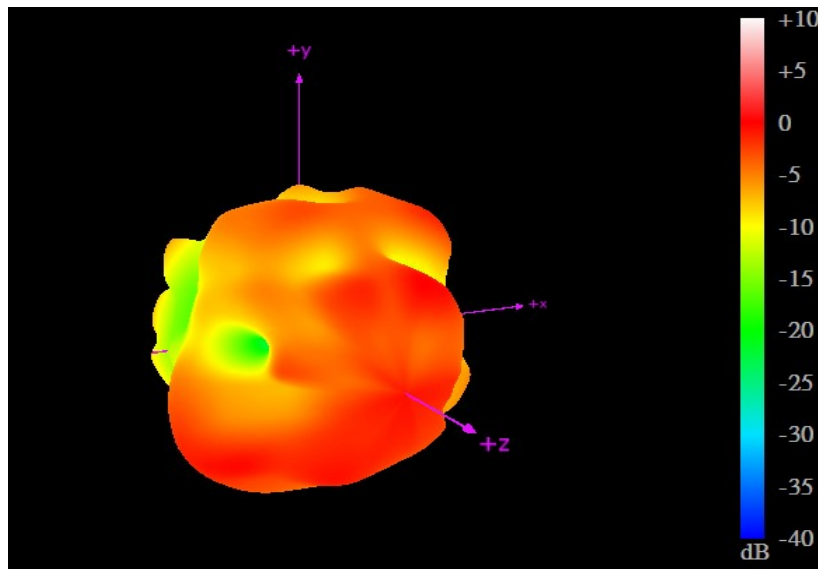

5550MHz

4. Mechanical Drawing (Unit: mm)

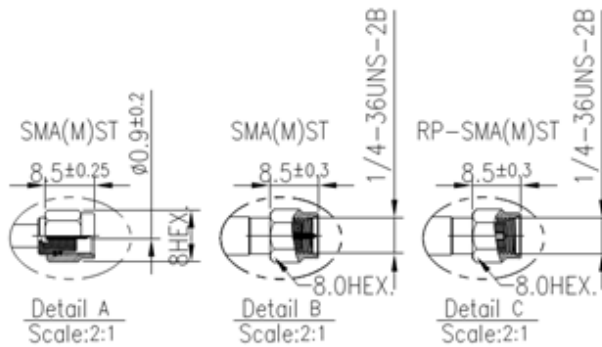
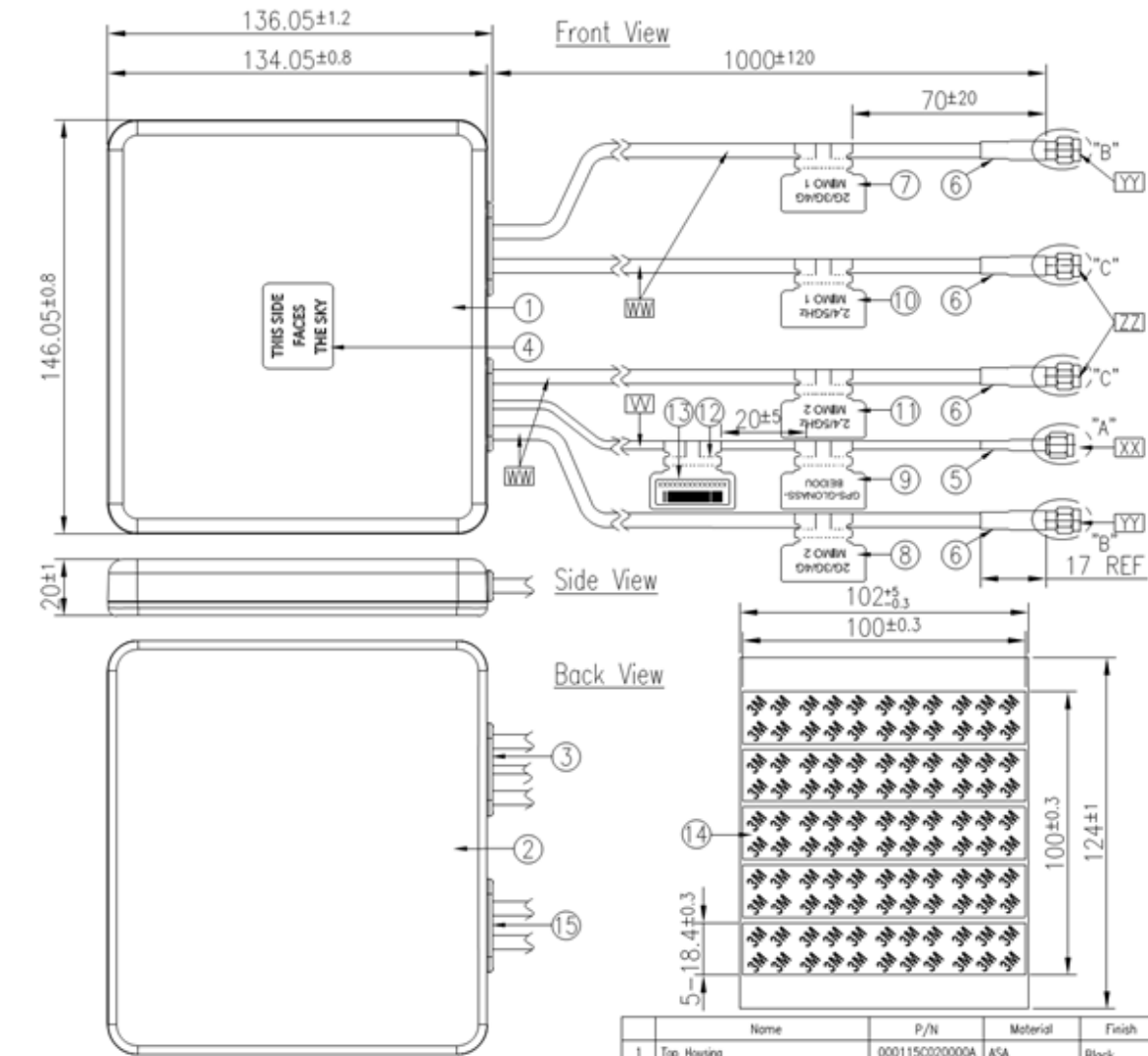

NOTES:

- All material must be RoHS compliant.
- The connector orientation has a fixed position to the antenna as per drawing.
- Part No.:MA950.WA.L101111.B10PP111.10PP111.C10PP151.G10PP151

Name	P/N	Material	Finish	QTY
1 Top Housing	000115C020000A	ASA	Black	1
2 Bottom Housing	000115C030000A	ASA	Black	1
3 Rubber-3 Holes	000715G000000A	Silicone Rubber	Black	1
4 Clear Label	001015H030000A	PET	Transparent	1
5 Heat Shrink Tube	001315C020000A	PE	Black	1
6 Heat Shrink Tube	001315C030000A	PE	Black	4
7 2G/3G/4G MIMO1 Label	001016B000000A	PEPA	Light Gray	1
8 2G/3G/4G MIMO2 Label	001016B010000A	PEPA	White	1
9 GPS-GLONASS-BEIDOU Label	001016B020000A	PEPA	Orange	1
10 2.4/5 GHz MIMO1 Label	001016B030000A	PEPA	Dark Green	1
11 2.4/5 GHz MIMO2 Label	001016B040000A	PEPA	Green Yellow	1
12 Empty Label(48*30)	001015G000000A	PEPA	White	1
13 Barcode Label(25*9)	001015G010000A	PET	White	1
14 Double sided Adhesive	001015C010000A	3M VHB 4615	White Liner	1
15 Rubber-2 Holes	000715H010000A	Silicone Rubber	Black	1

Name	P/N	Material	Finish	QTY
W Cable Type	301315C000000A	RG174	Black	1
WW Cable Type	305416B000000A	KSR200-P	Black	4
XX Connector Type(RG174)	200216B00005BA	SMA(M)ST	Au Plated	1
YY Connector Type(KSR200-P)	200215K00004BA	SMA(M)ST	Au Plated	2
ZZ Connector Type(KSR200-P)	200215K01004BA	RP-SMA(M)ST	Au Plated	2

5. Packaging

MA950.W.A.LBICG.005

Packaging Specifications

1 No. MA950.W.A.LBICG.005 per small box
 Box Dimensions - 250 x 210 x 100mm
 Weight - 640g

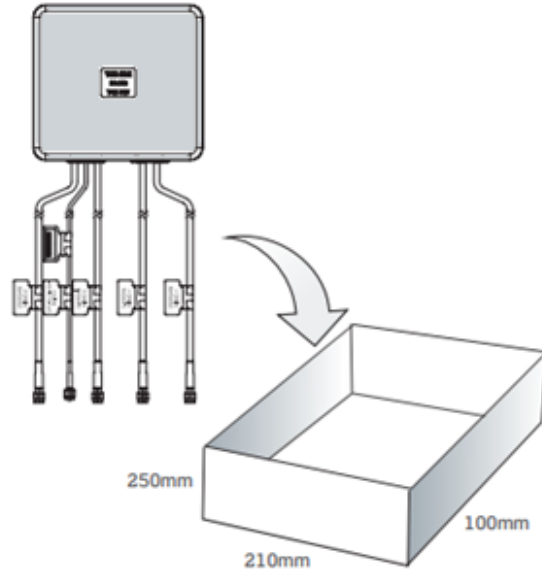

1 Outer Carton
 Carton Dimensions - 440 x 440 x 300mm
 8 pcs MA950.W.A.LBICG.005 per carton
 Weight - 5.5Kg

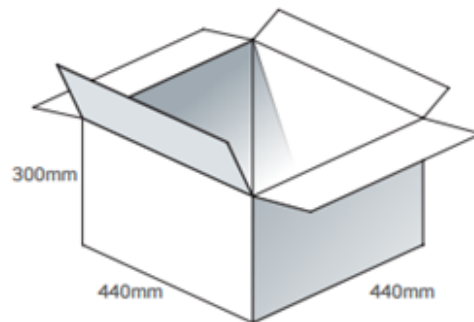

Pallet Dimensions 1200*1000*1100mm
 12 Cartons per Pallet
 6 Cartons per layer
 2 Layers

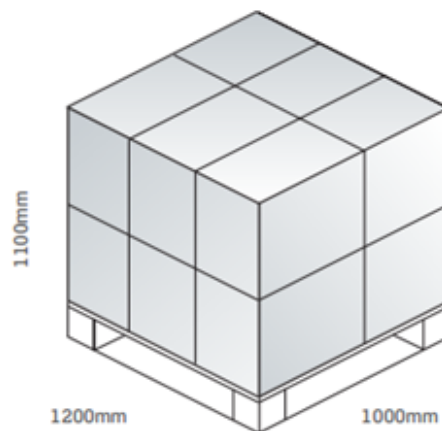

6. Application Note

The MA950 antenna performance with different cable lengths is shown below.

6.1. In free space (LTE)

6.1.1. Return Loss (LTE_MIMO_1)

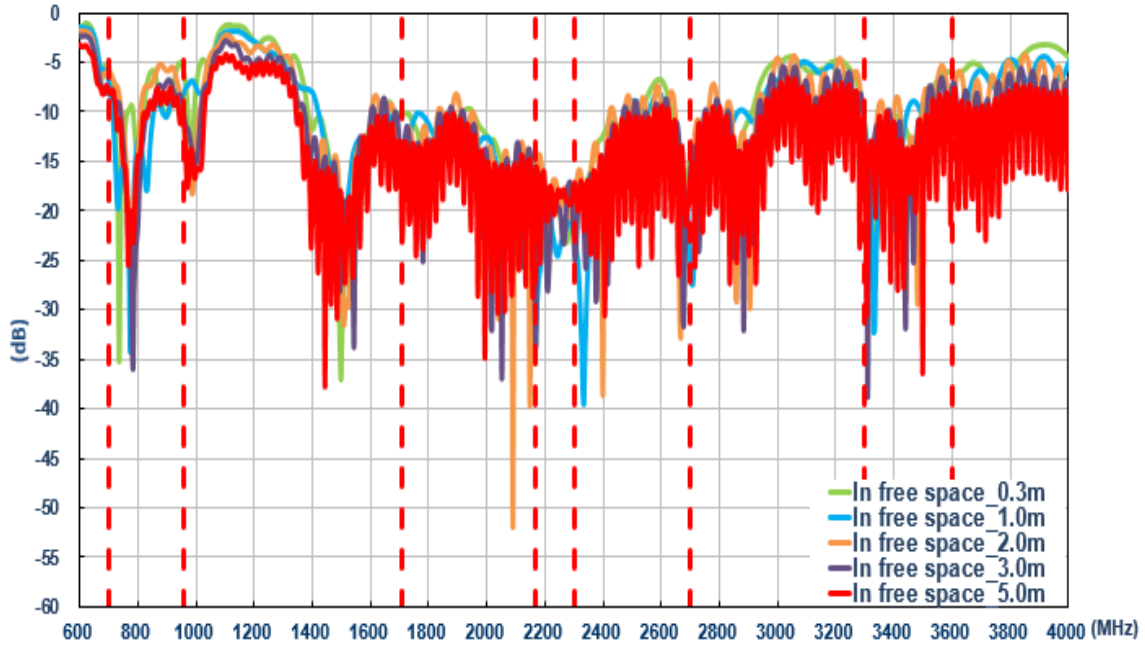

6.1.2. Return Loss (LTE_MIMO_2)

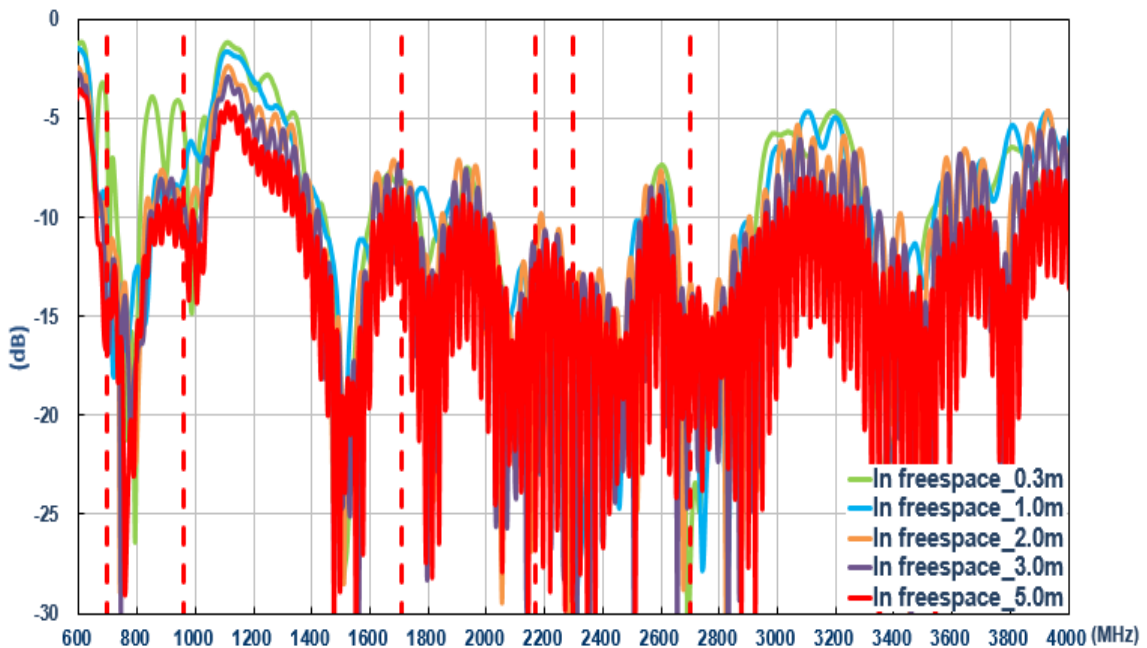

6.1.3. Isolation (LTE antenna)

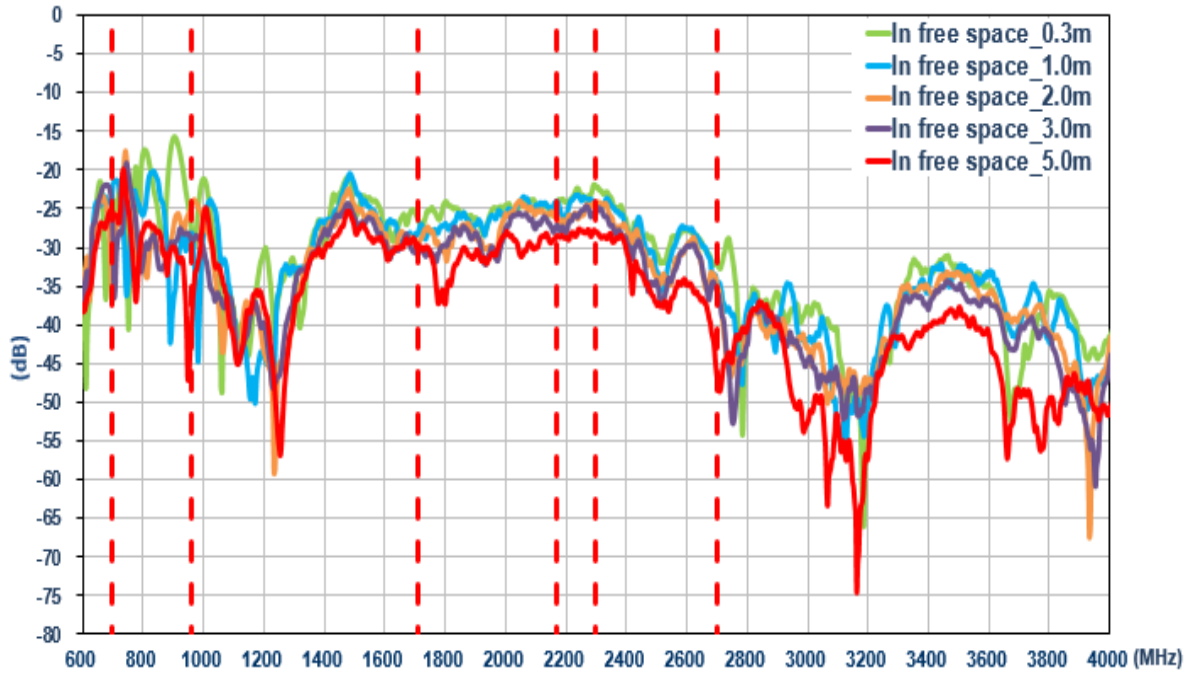

6.1.4. Efficiency (LTE MIMO_1)

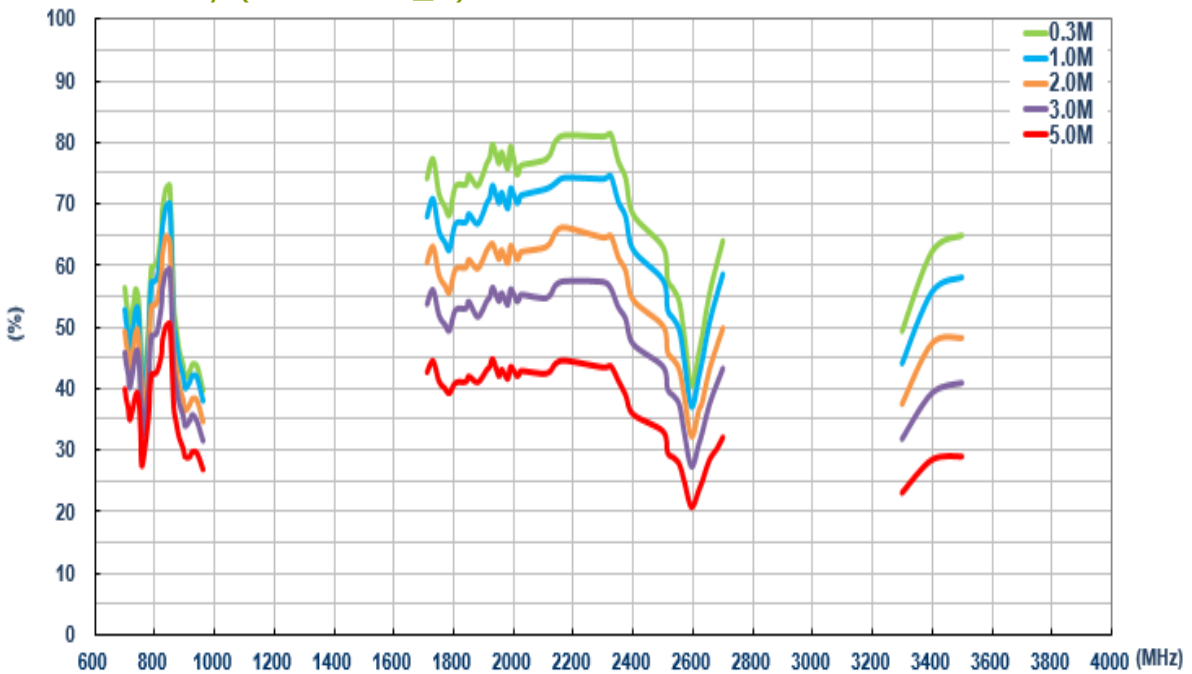

6.1.5. Efficiency (LTE MIMO_2)

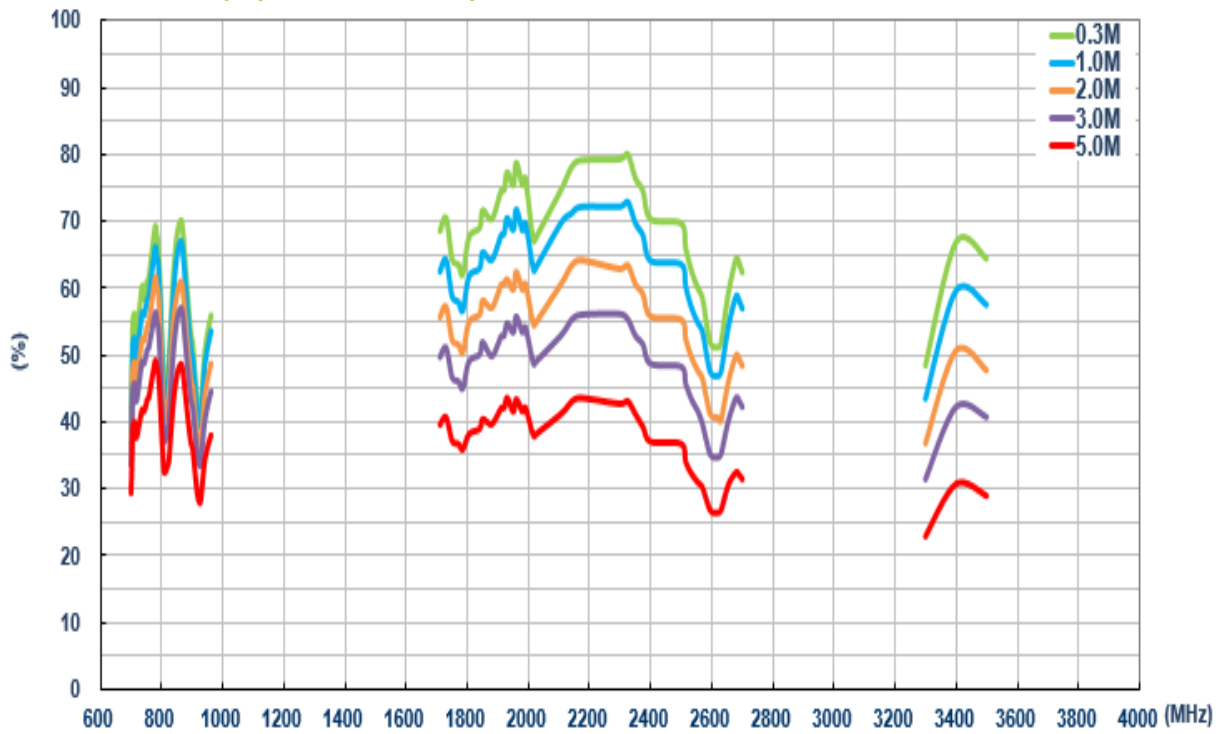

6.1.6. Average Gain (LTE MIMO_1)

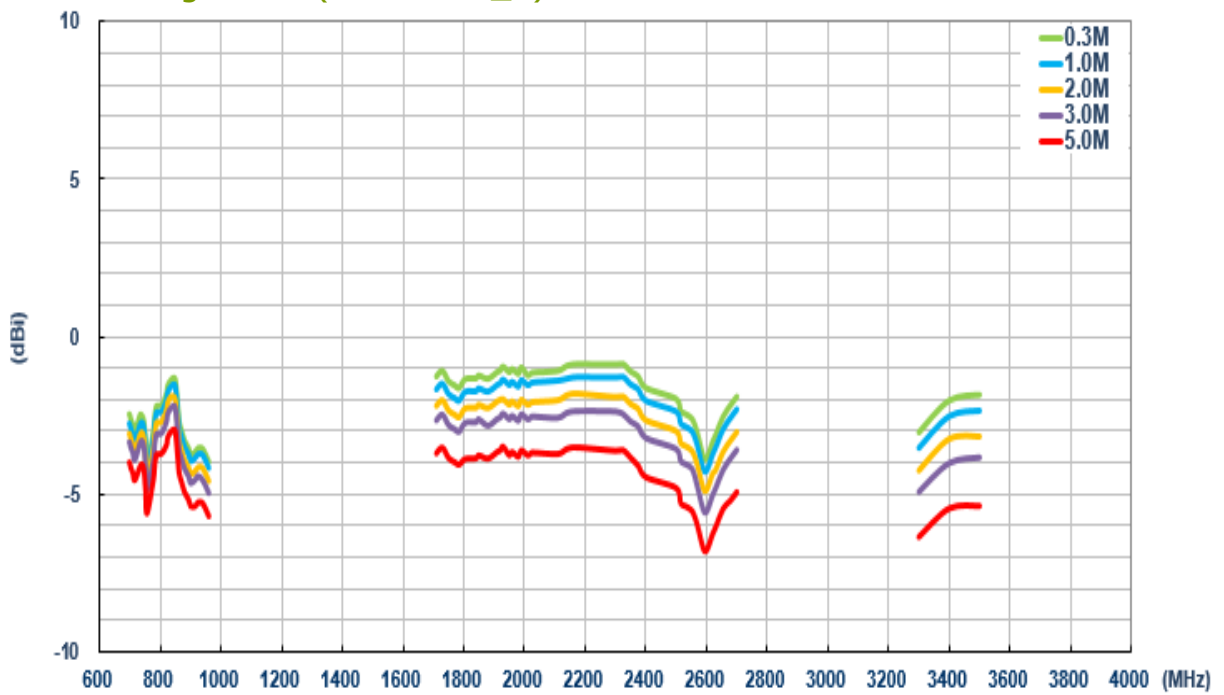

6.1.7. Average Gain (LTE MIMO_2)

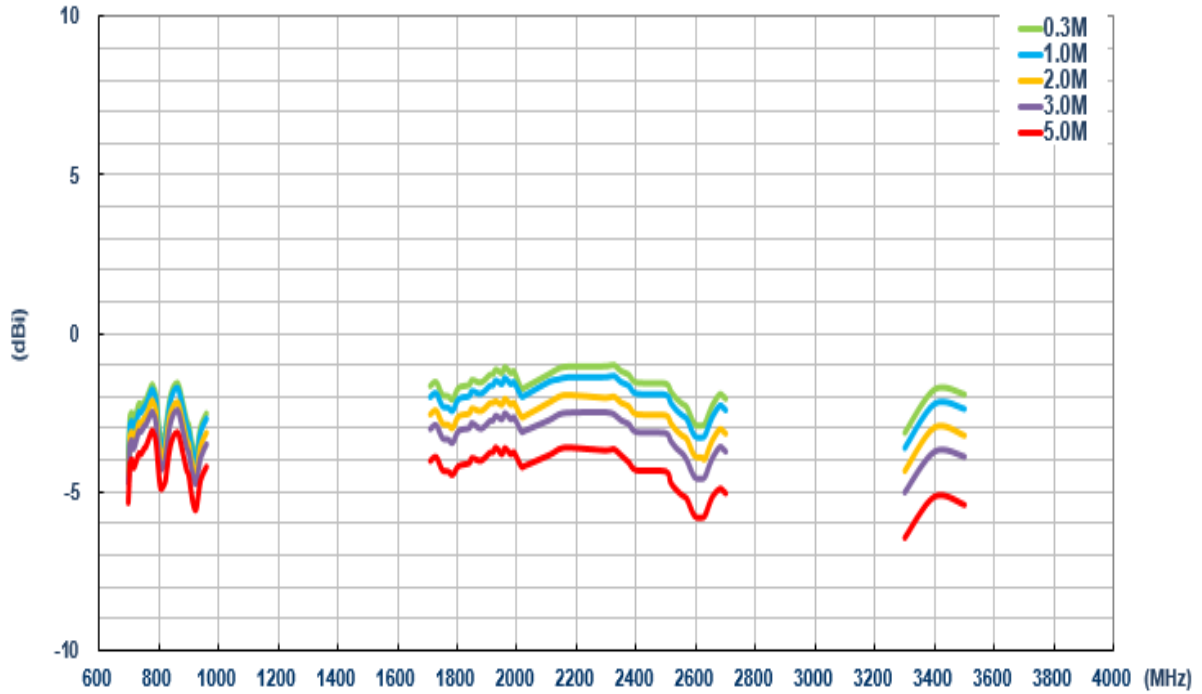

6.1.8. Peak Gain (LTE MIMO_1)

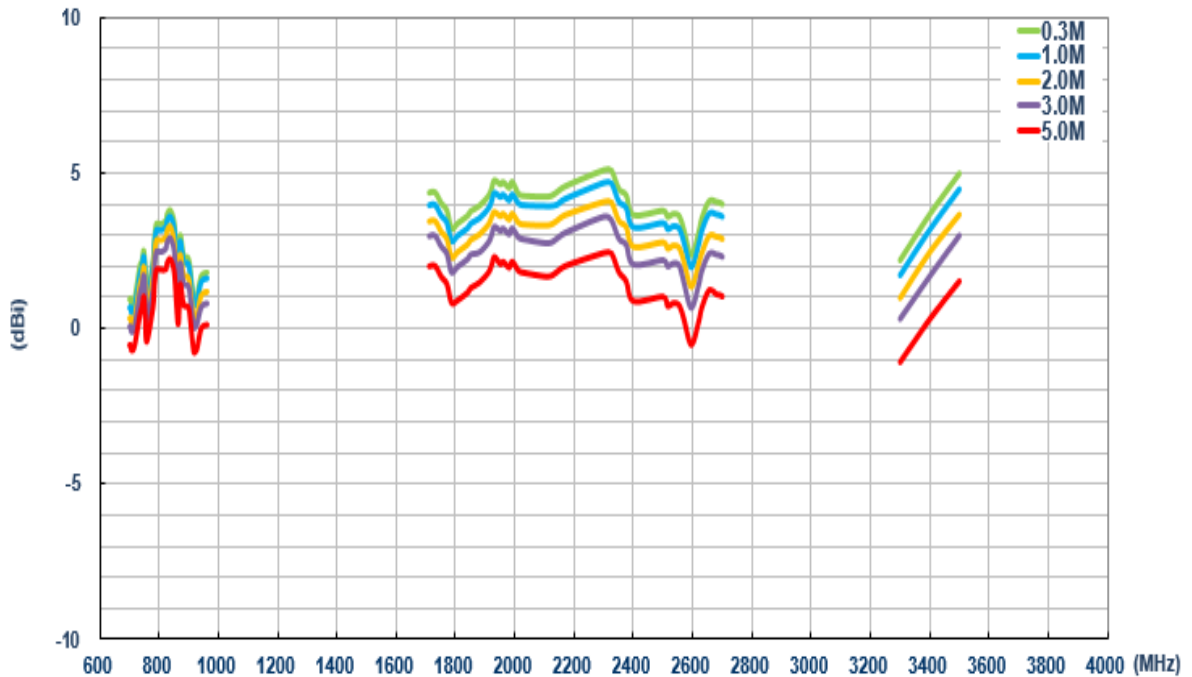

6.1.9. Peak Gain (LTE MIMO_2)

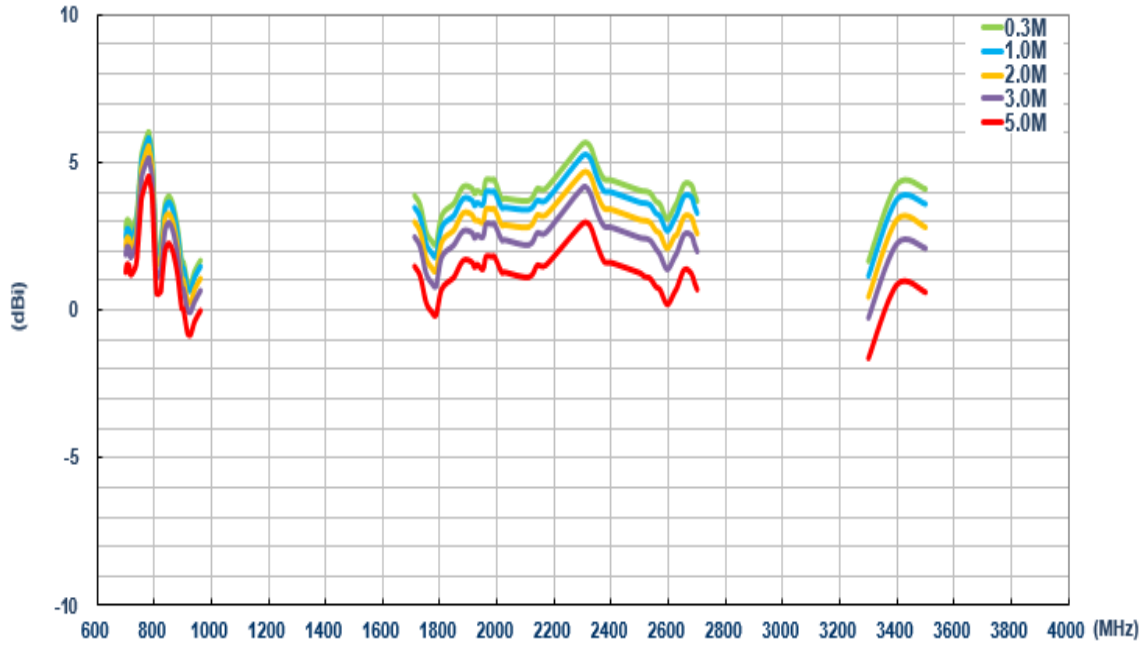

6.2. In free space (Wi-Fi)

6.2.1. Return Loss (Wi-Fi_MIMO_1)

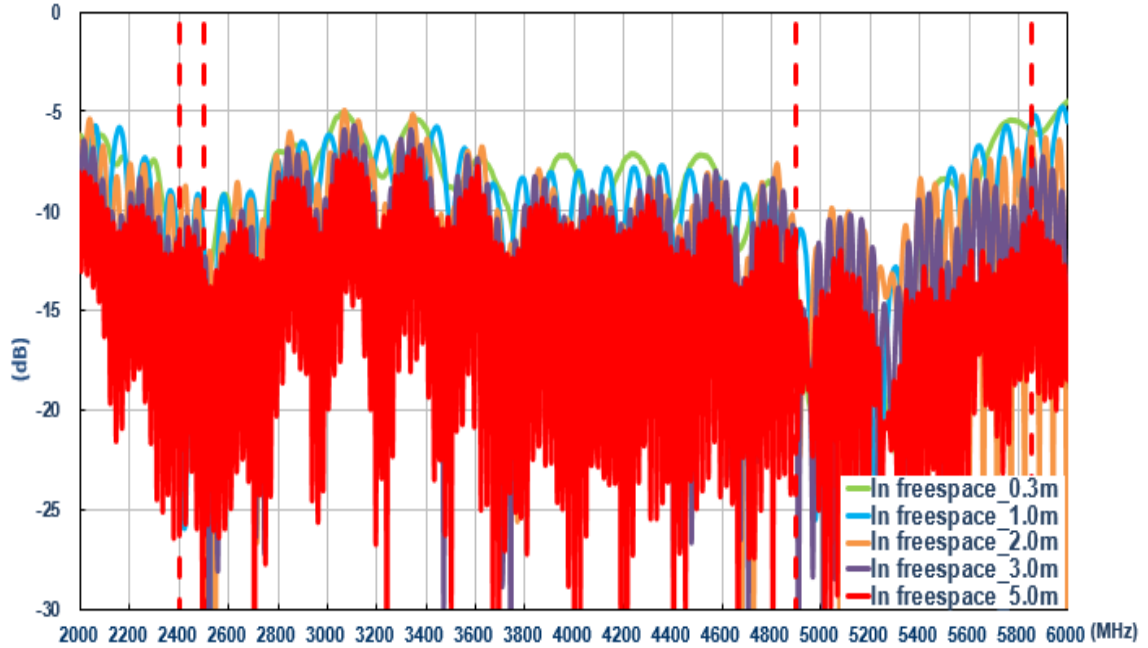

6.2.2. Return Loss (Wi-Fi_MIMO_2)

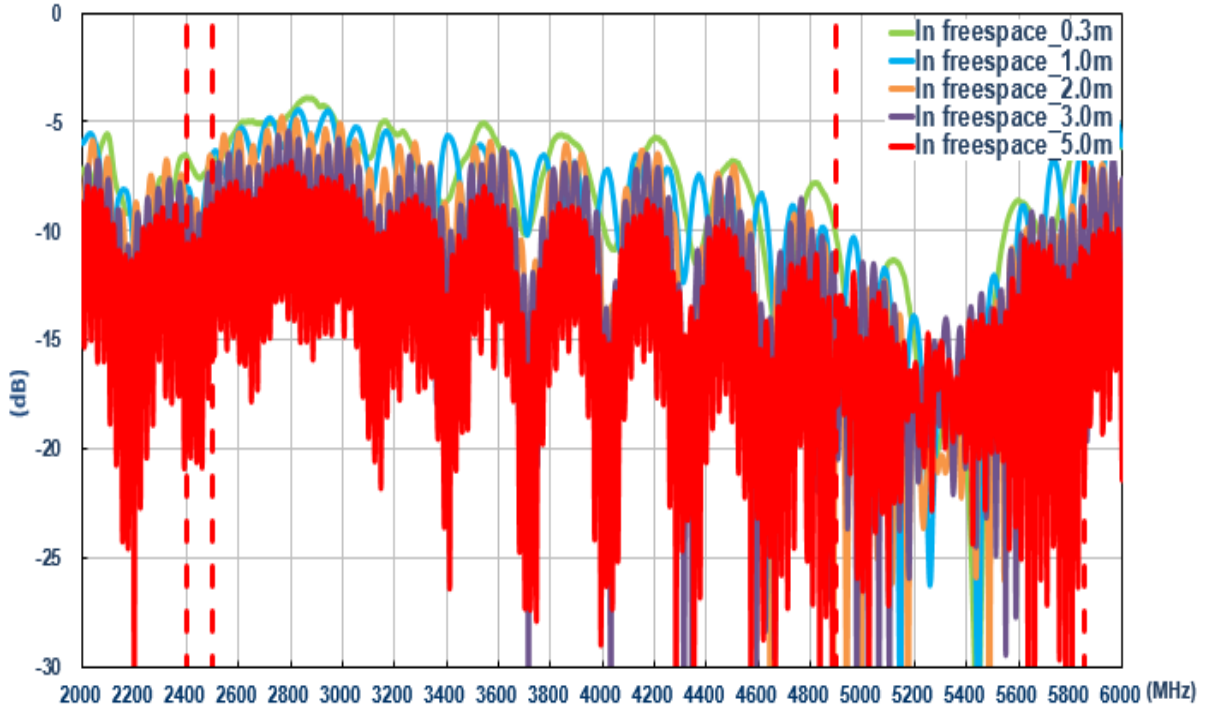

6.2.3. Isolation (Wi-Fi)

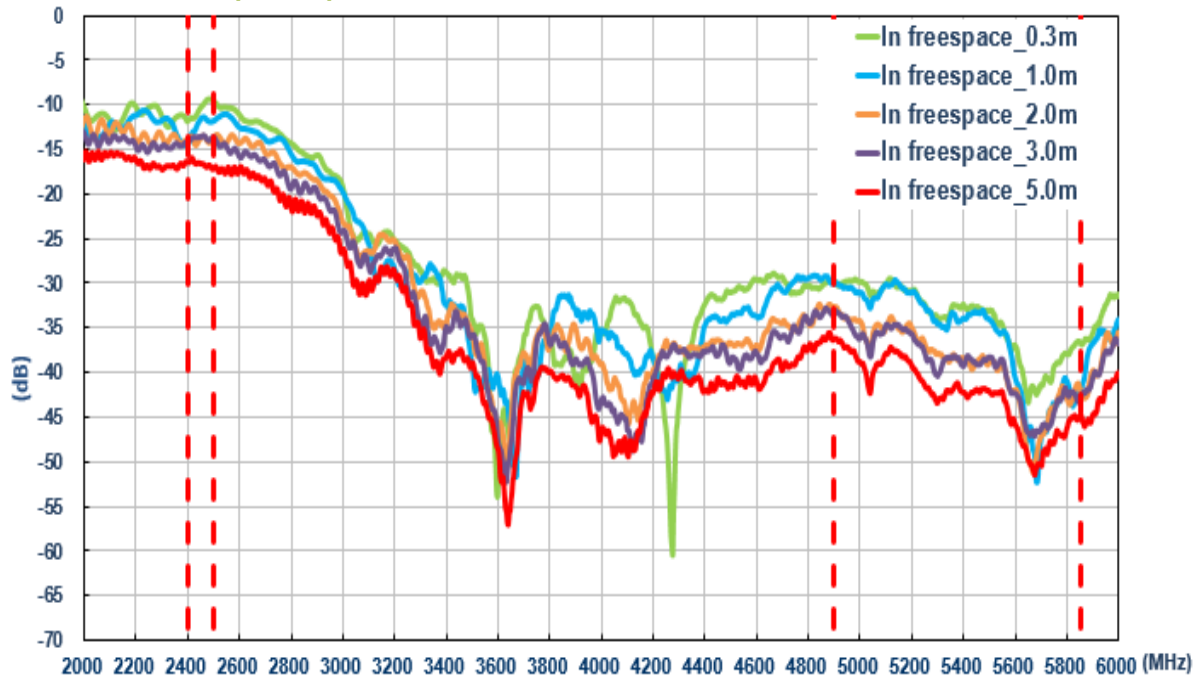

6.2.4. Efficiency (Wi-Fi MIMO_1)

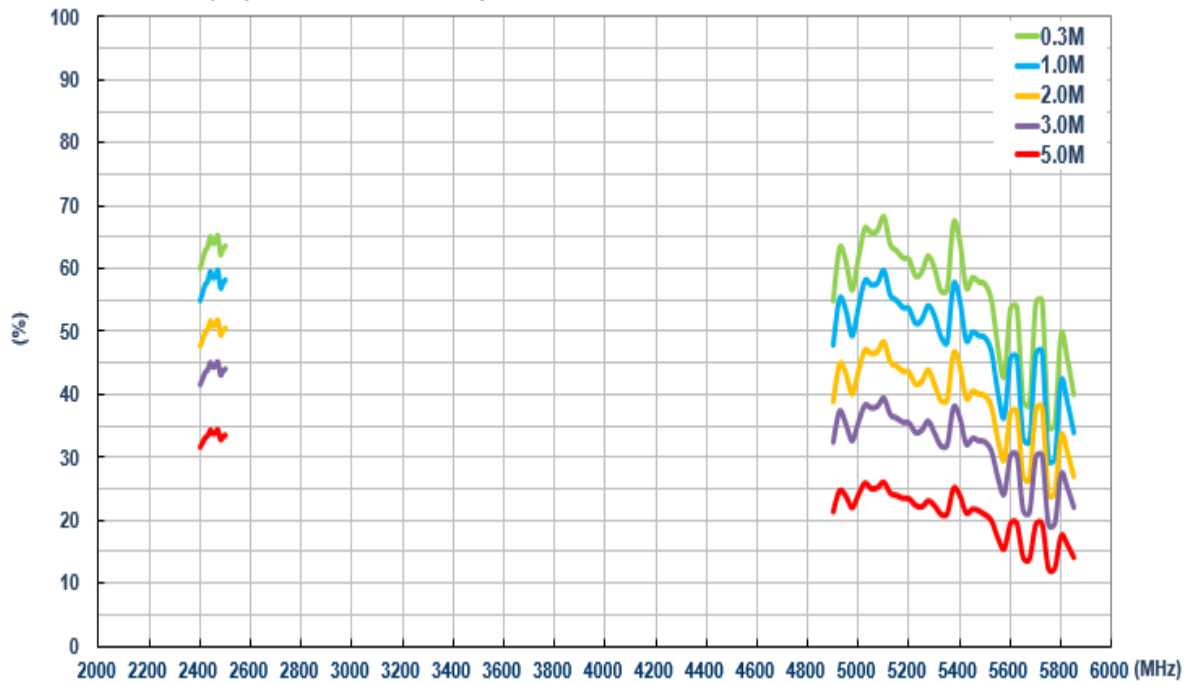

6.2.5. Efficiency (Wi-Fi MIMO_2)

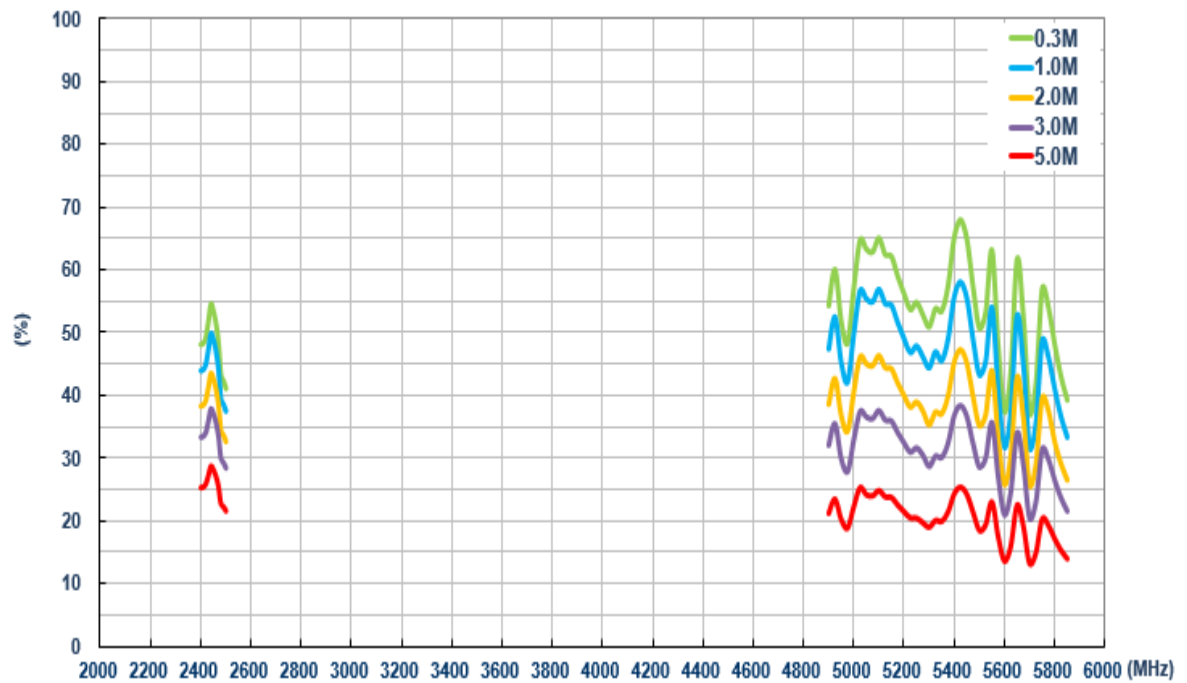

6.2.6. Average Gain (Wi-Fi MIMO_1)

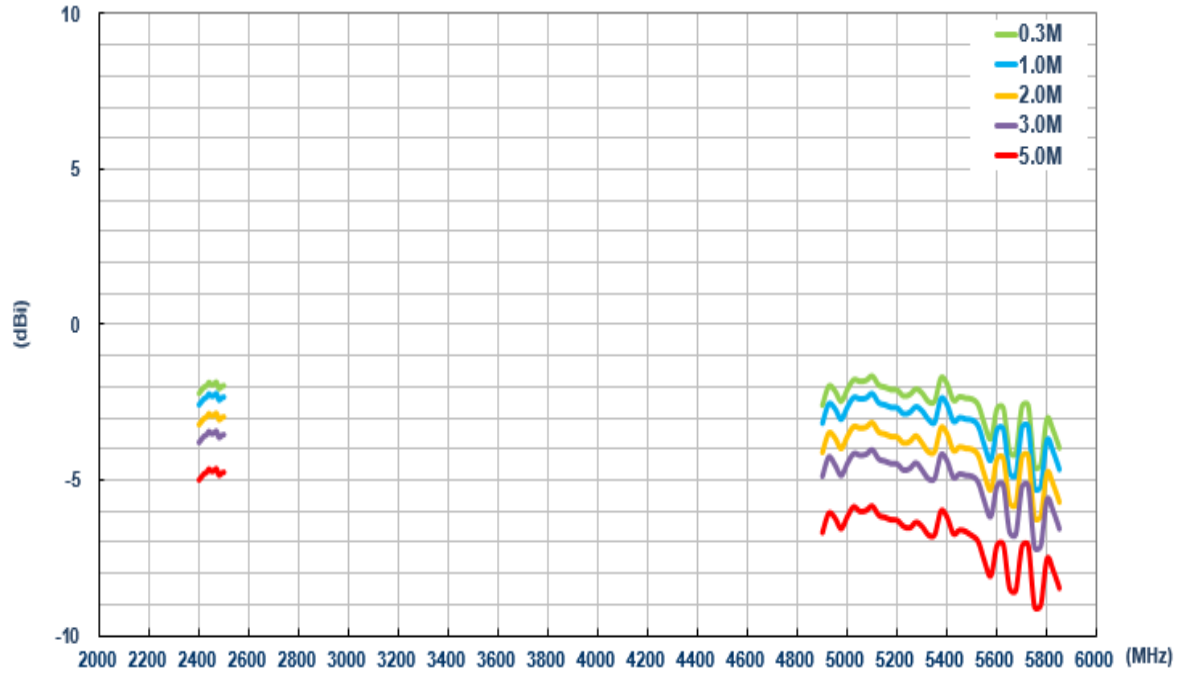

6.2.7. Average Gain (Wi-Fi MIMO_2)

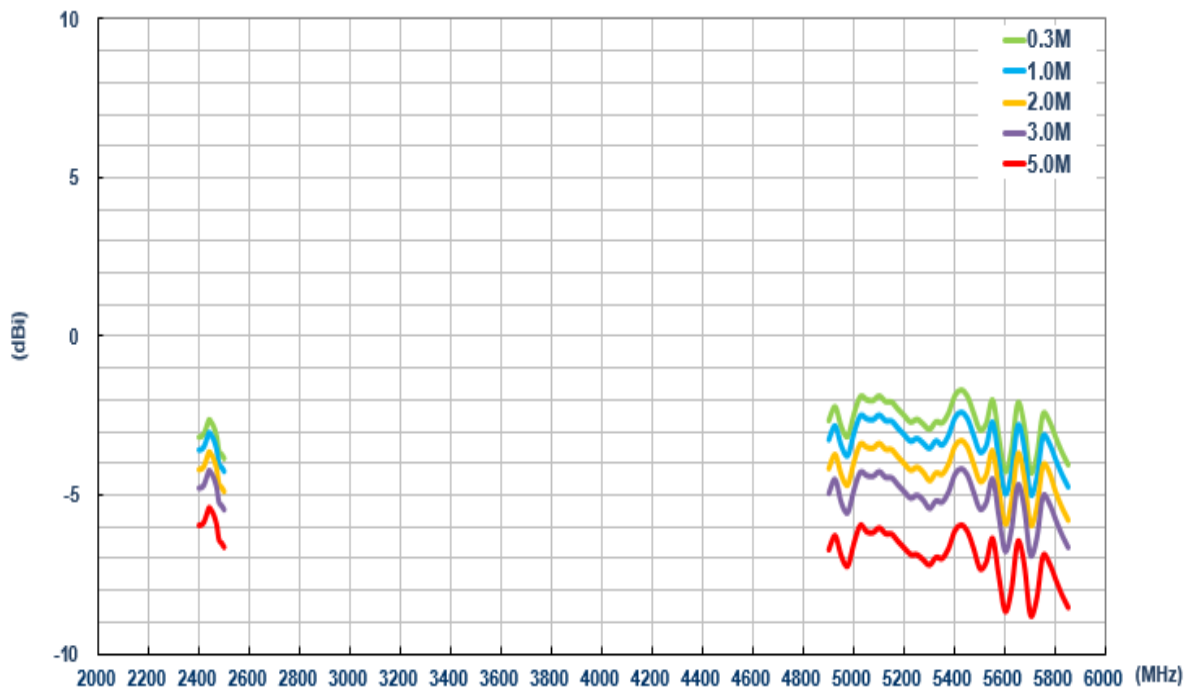

6.2.8. Peak Gain (Wi-Fi MIMO_1)

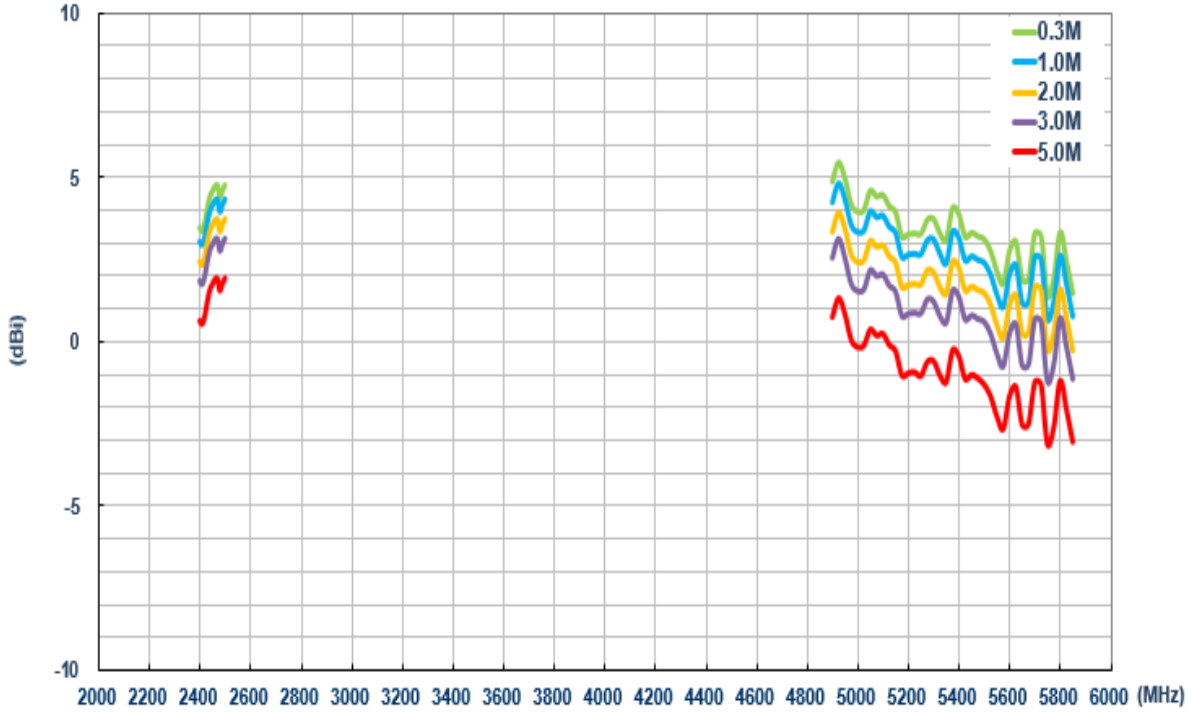

6.2.9. Peak Gain (Wi-Fi MIMO_2)

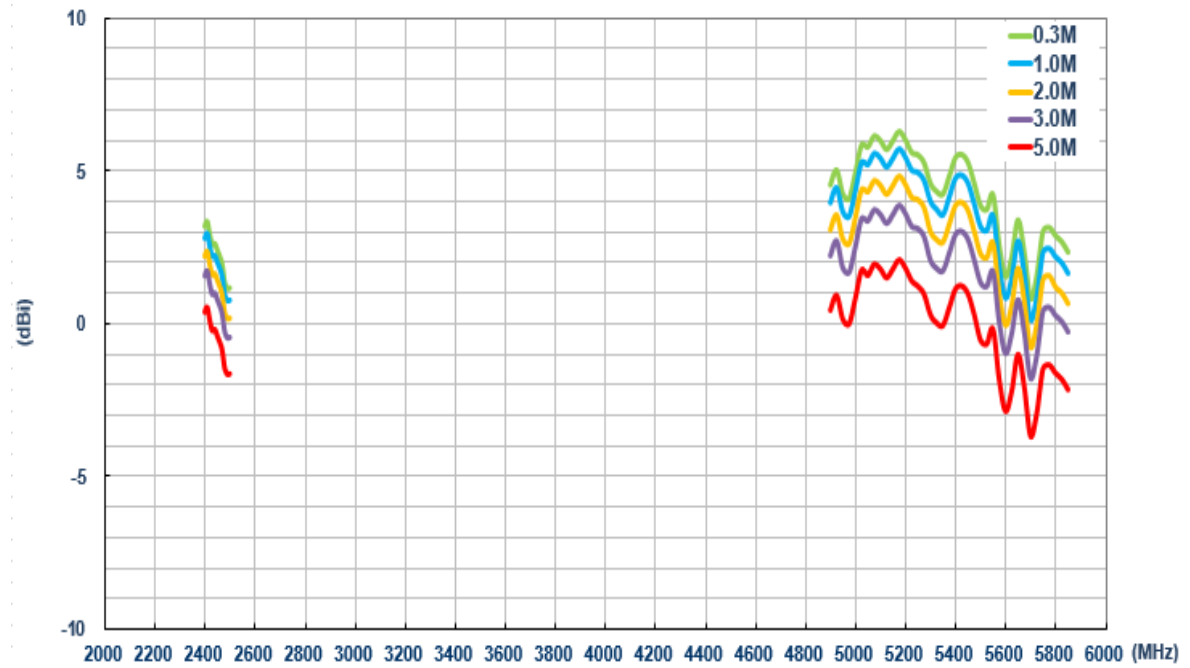

6.3. On the ABS (LTE)

6.3.1. Return Loss (LTE_MIMO_1)

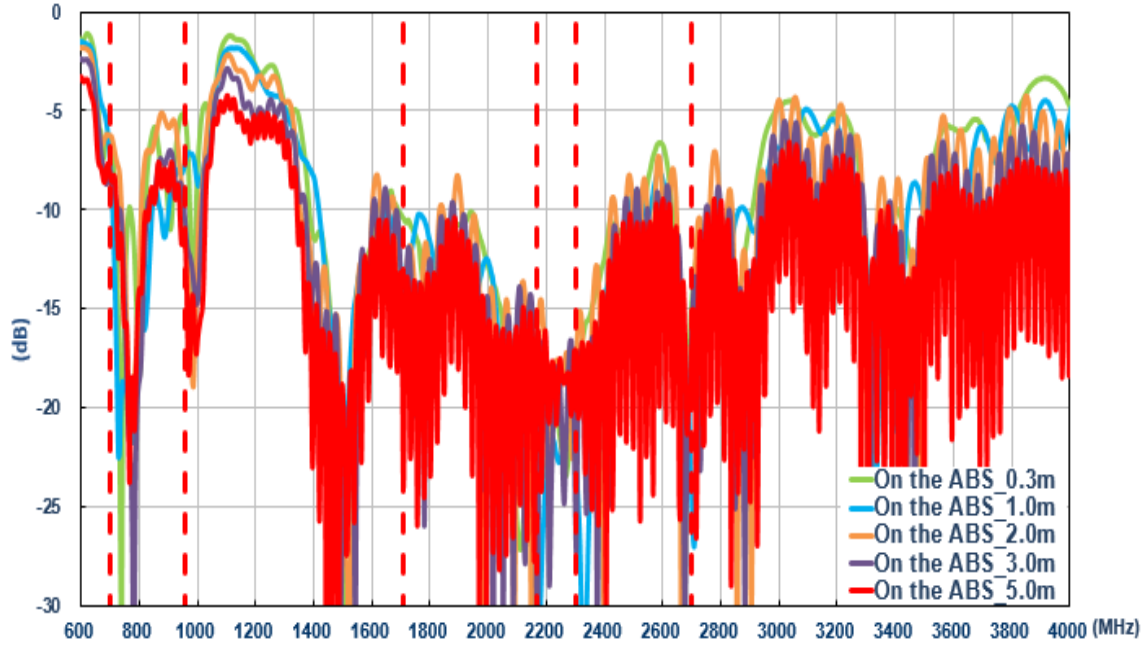

6.3.2. Return Loss (LTE_MIMO_2)

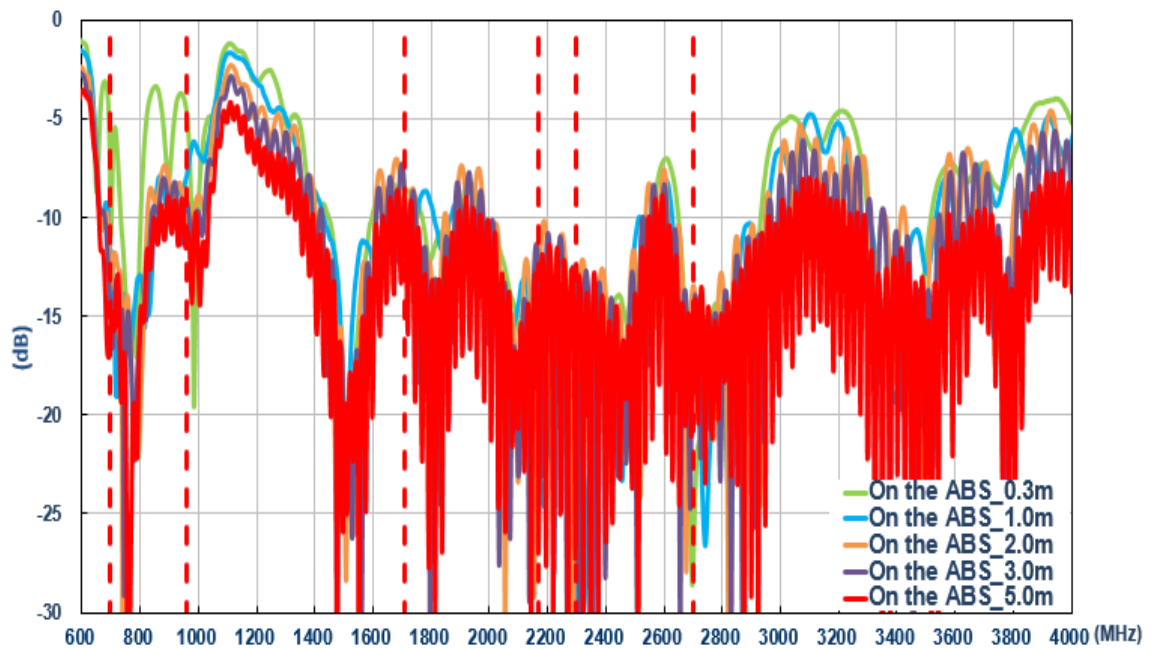

6.3.3. Isolation (LTE antenna)

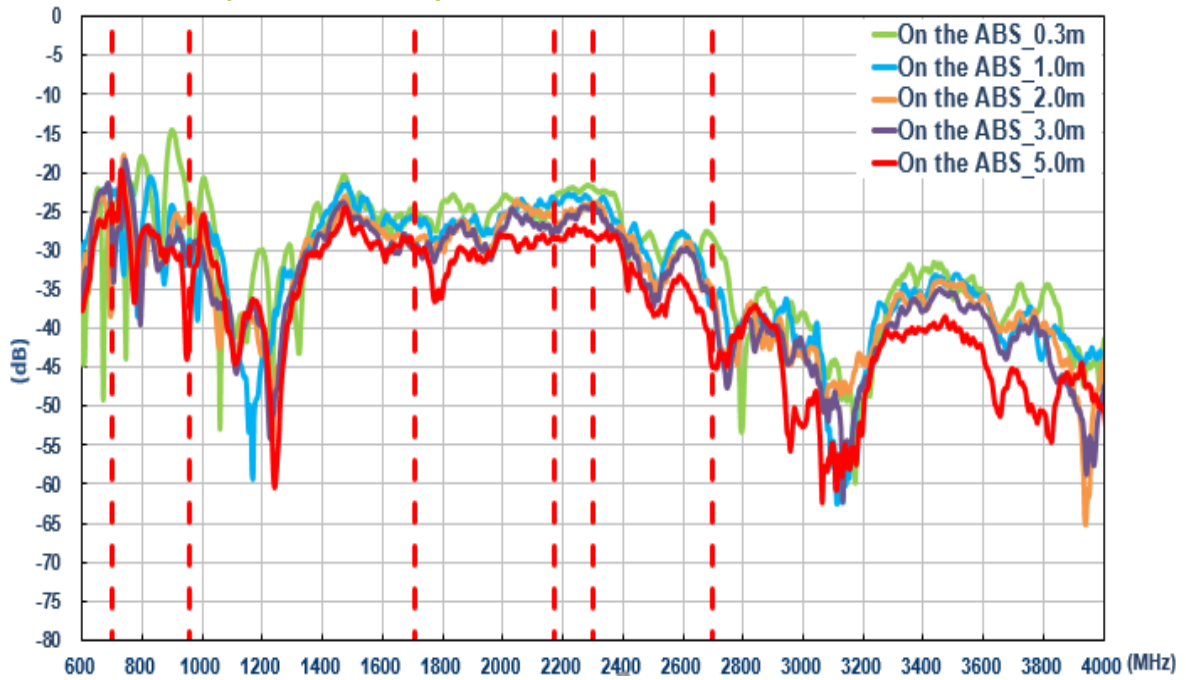

6.3.4. Efficiency (LTE MIMO_1)

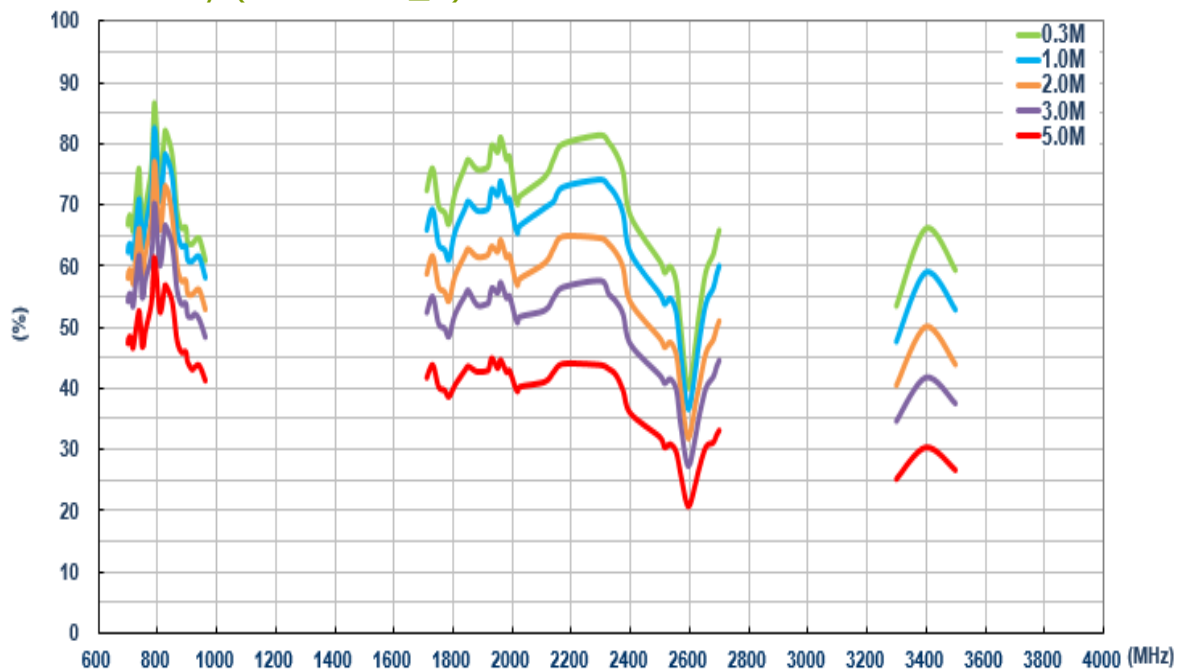

6.3.5. Efficiency (LTE MIMO_2)

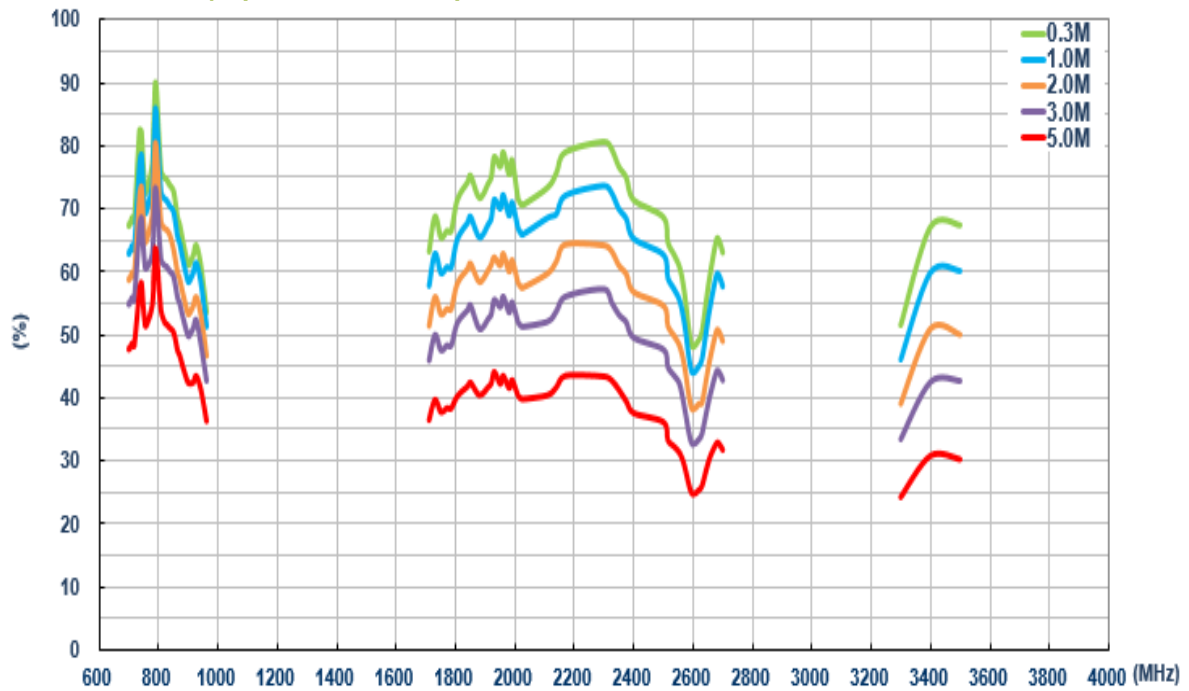

6.3.6. Average Gain (LTE MIMO_1)

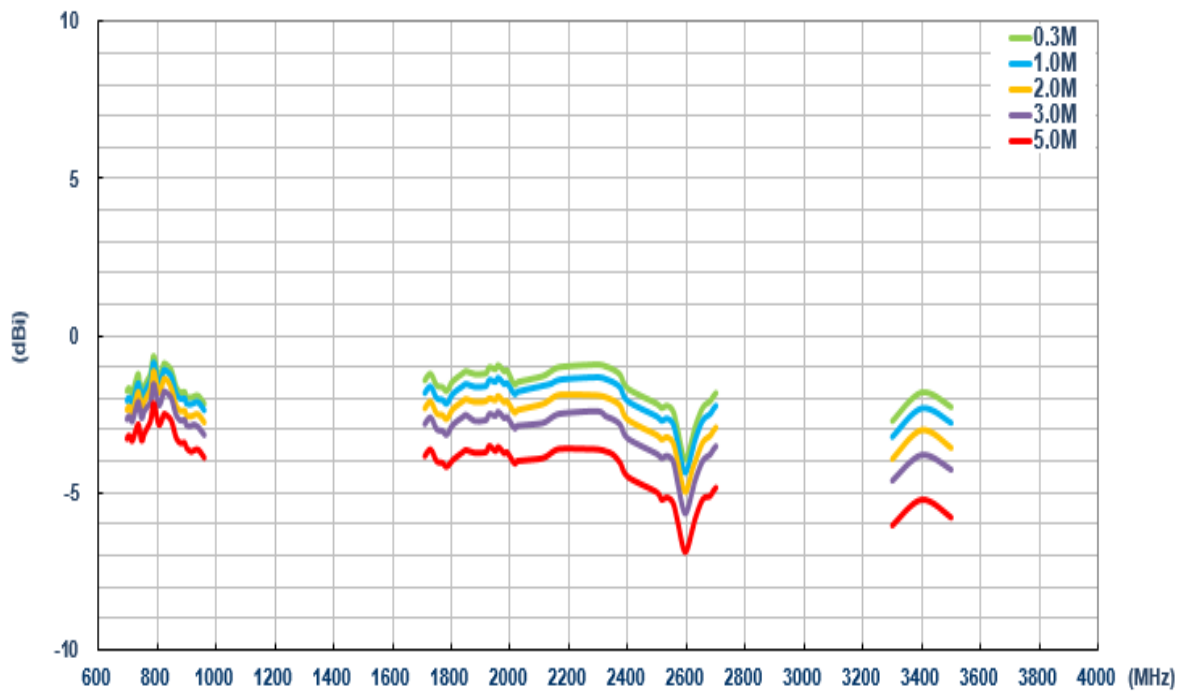

6.3.7. Average Gain (LTE MIMO_2)

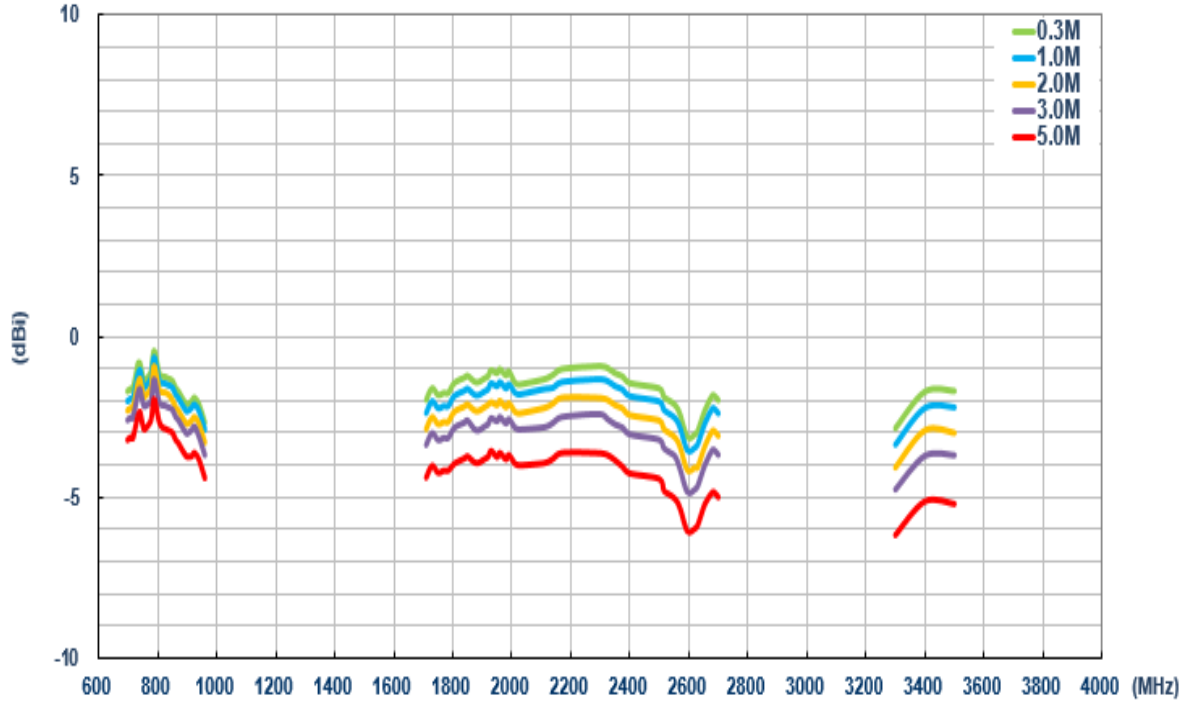

6.3.8. Peak Gain (LTE MIMO_1)

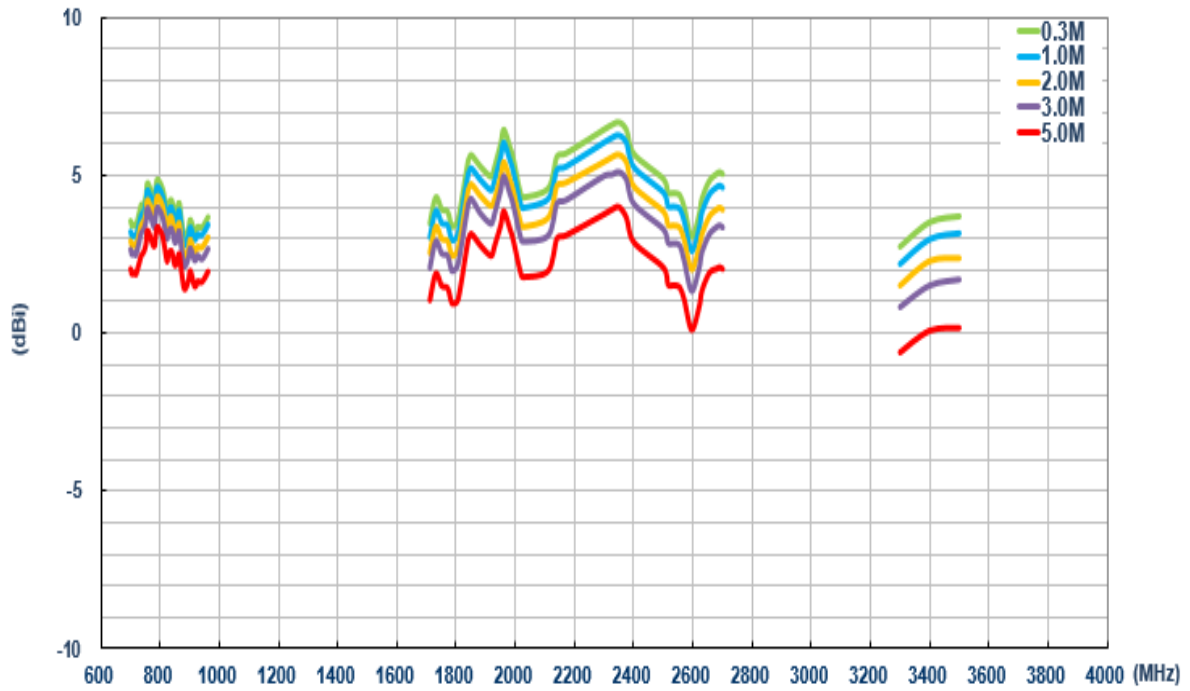

6.3.9. Peak Gain (LTE MIMO_2)

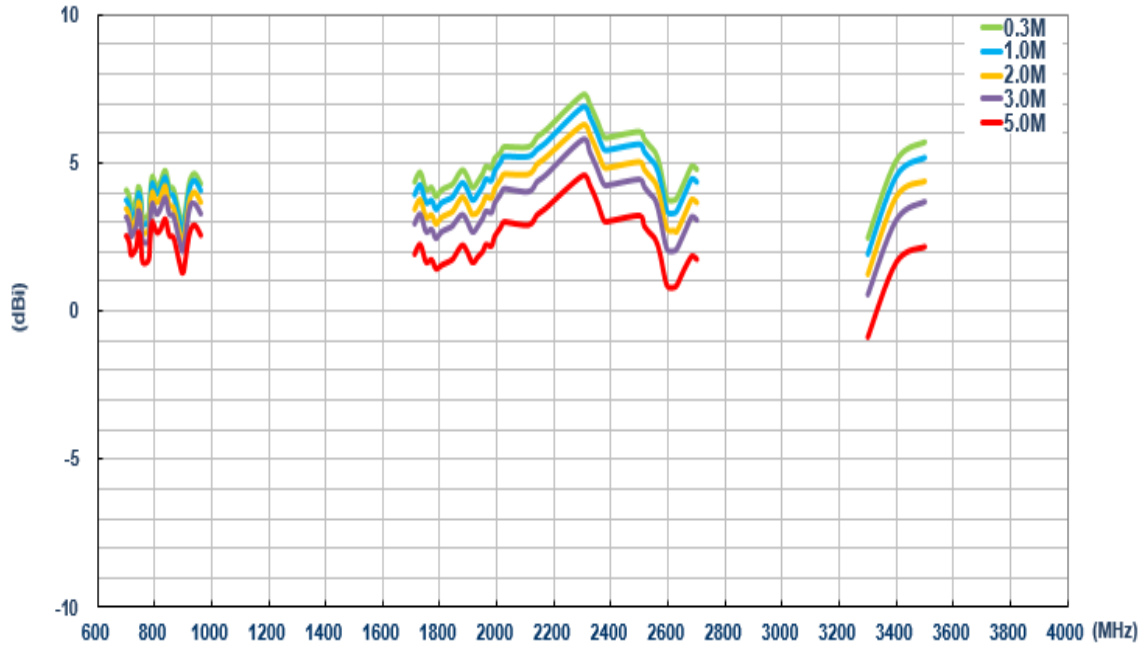

6.4. On ABS (Wi-Fi)

6.4.1. Return Loss (Wi-Fi_MIMO_1)

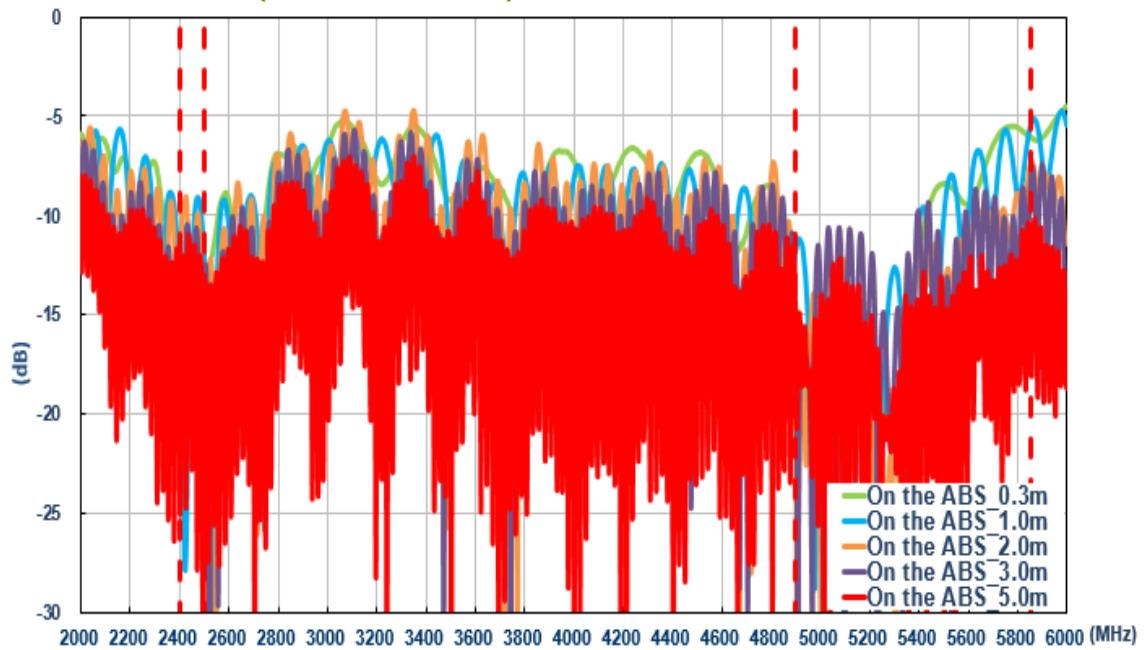

6.4.2. Return Loss (Wi-Fi_MIMO_2)

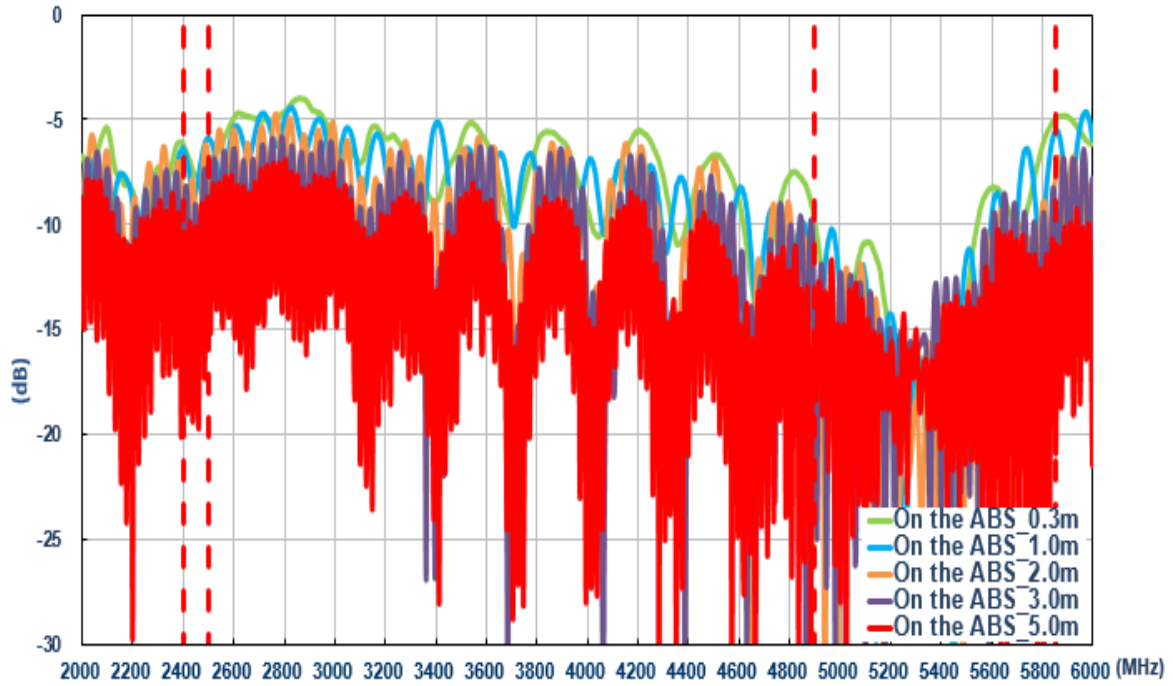

6.4.3. Isolation (Wi-Fi)

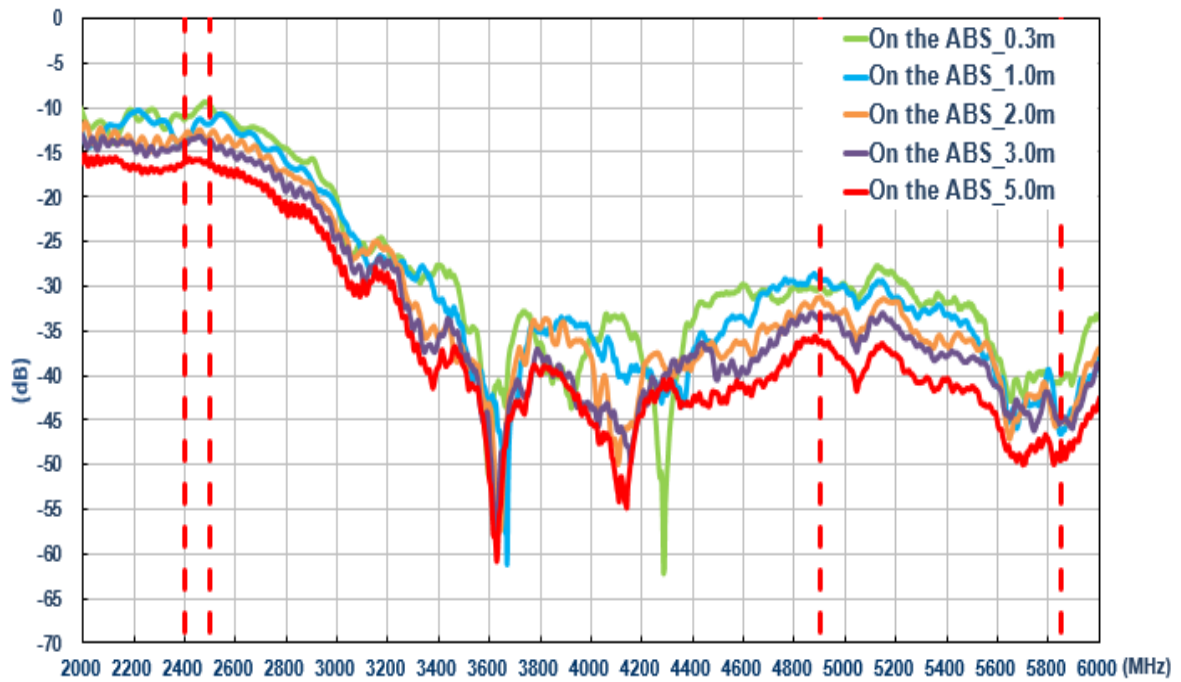

6.4.4. Efficiency (Wi-Fi MIMO_1)

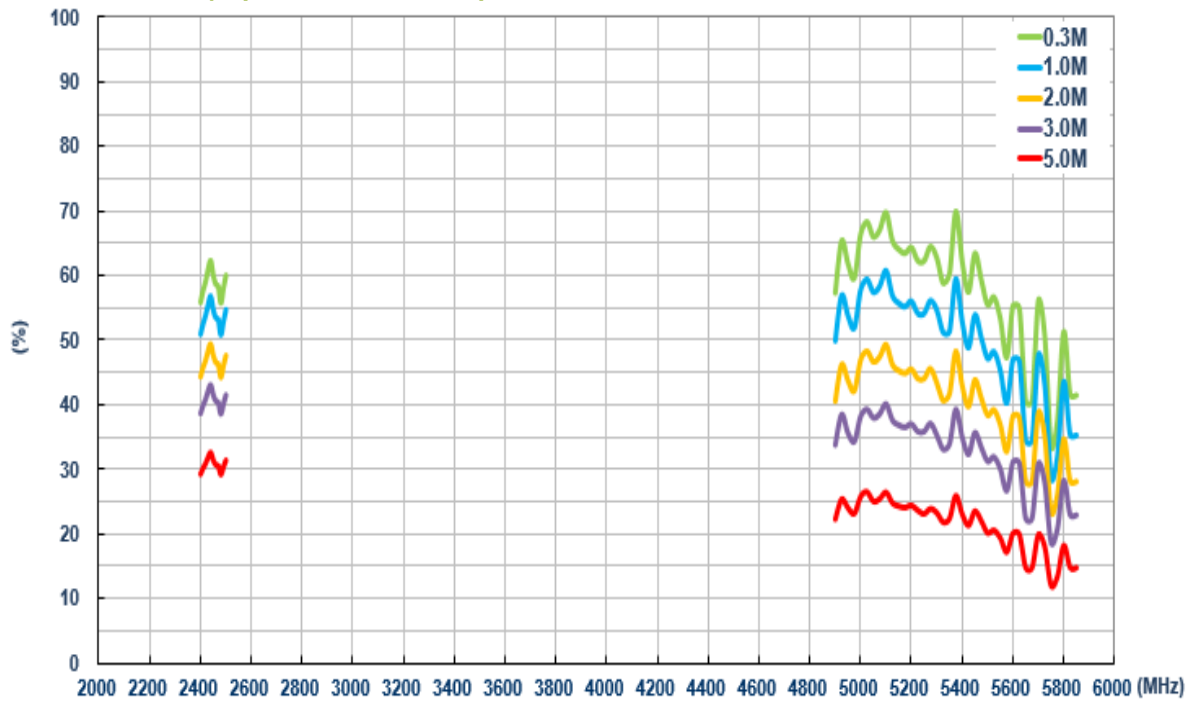

6.4.5. Efficiency (Wi-Fi MIMO_2)

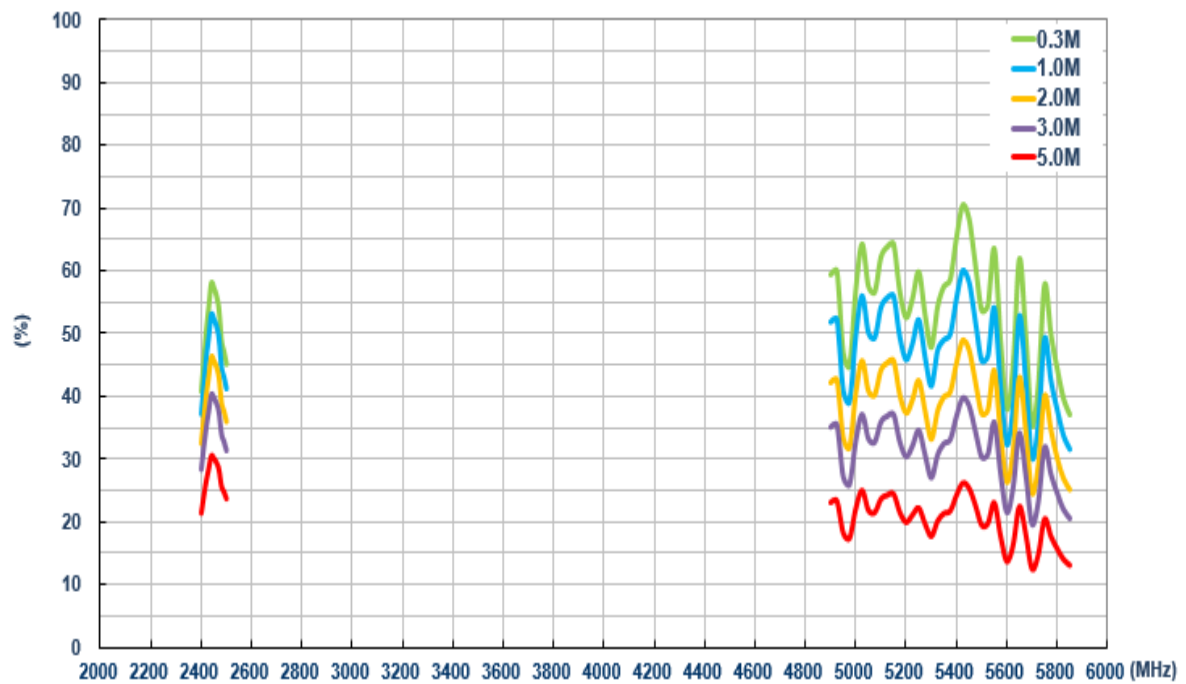

6.4.6. Average Gain (Wi-Fi MIMO_1)

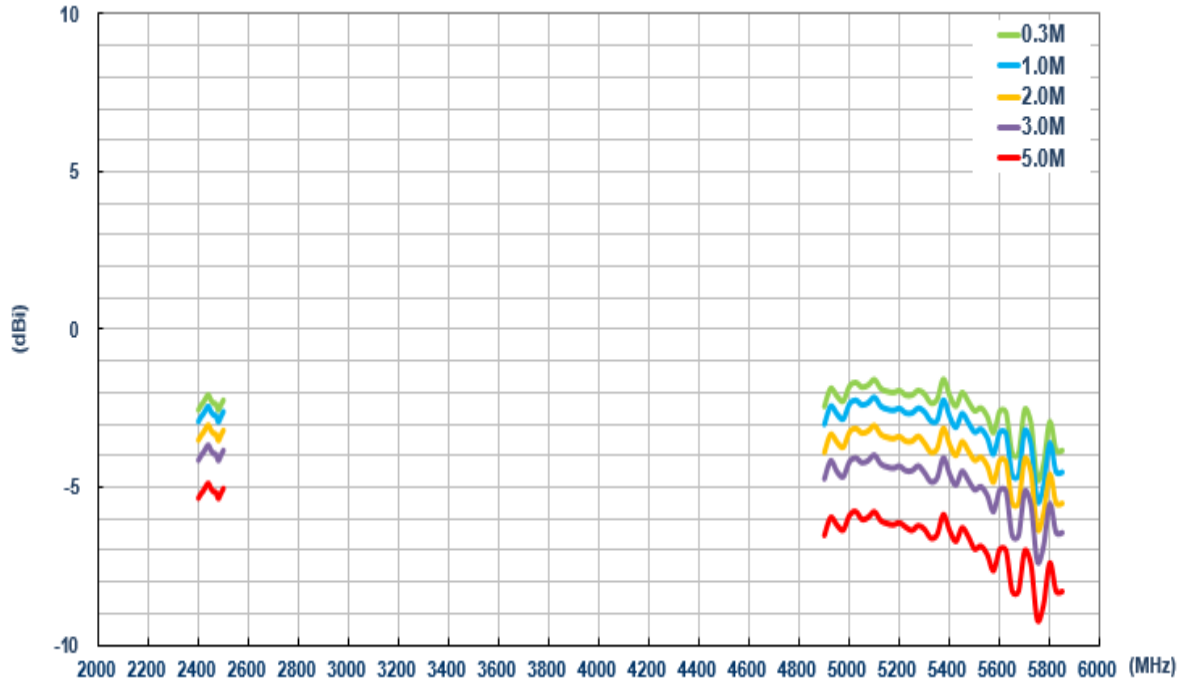

6.4.7. Average Gain (Wi-Fi MIMO_2)

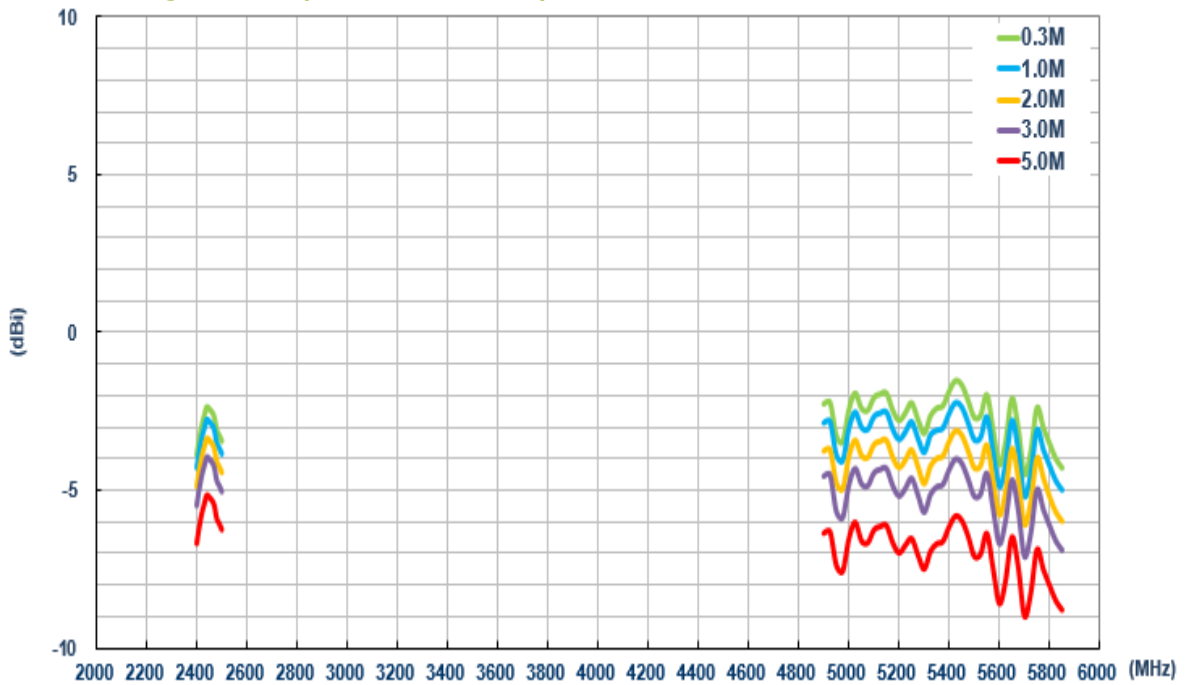

6.4.8. Peak Gain (Wi-Fi MIMO_1)

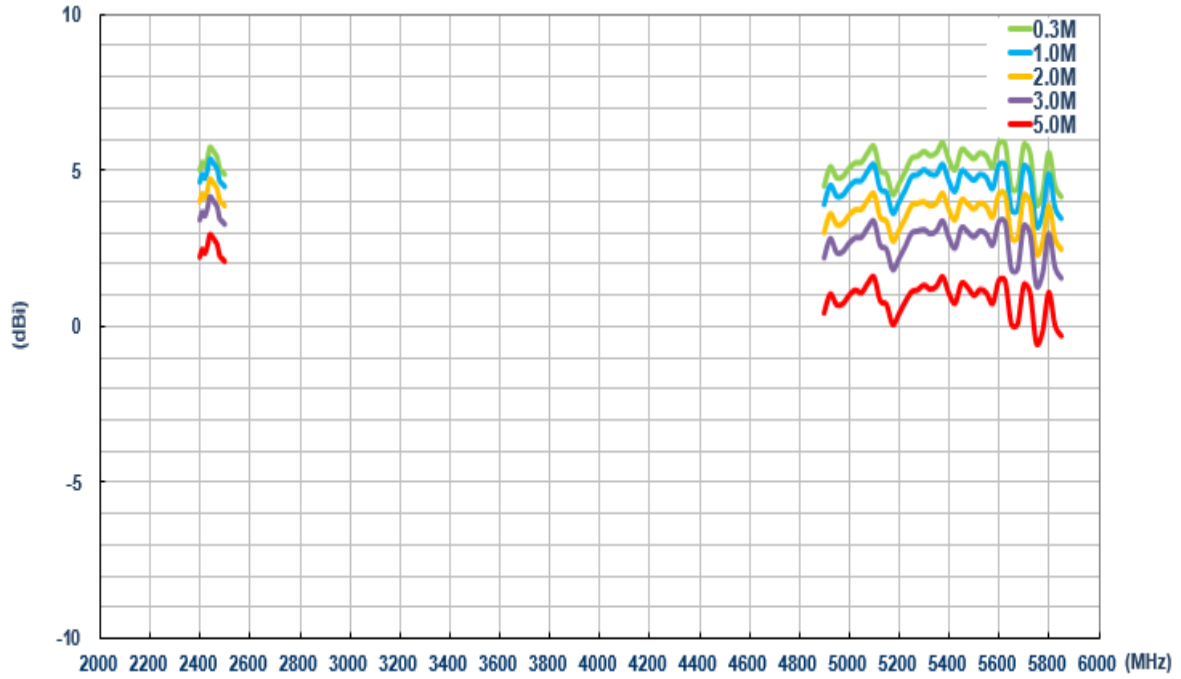

6.4.9. Peak Gain (Wi-Fi MIMO_2)

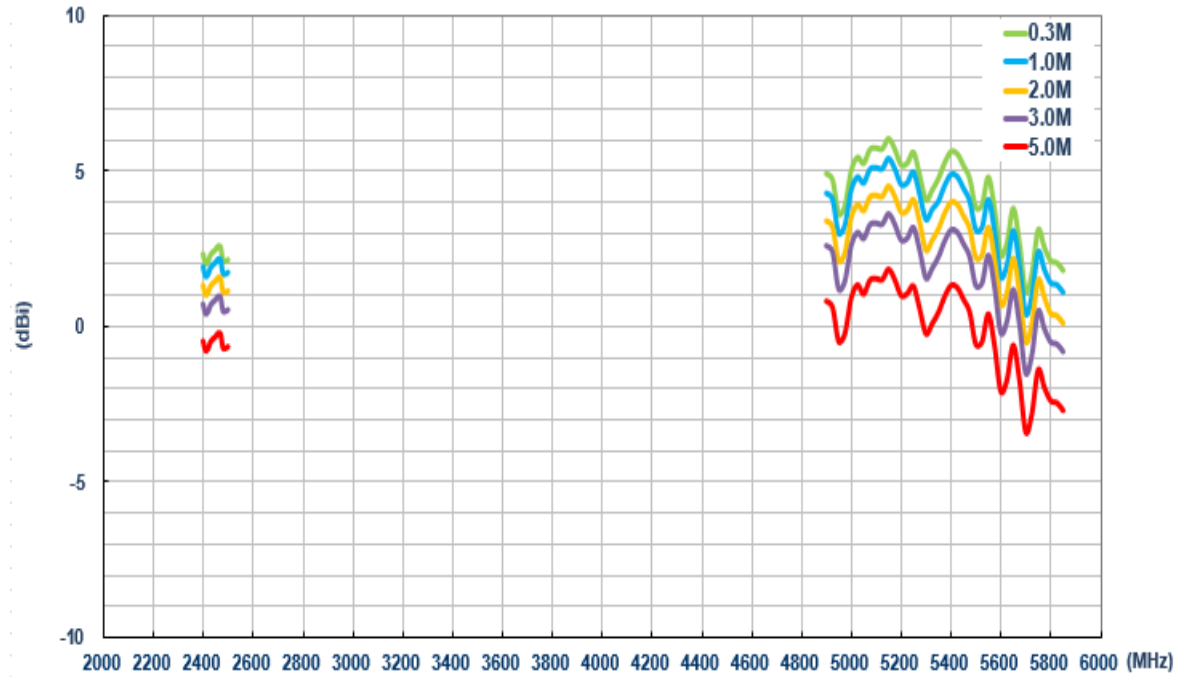

6.5. On glass (LTE)

6.5.1. Return Loss (LTE_MIMO_1)

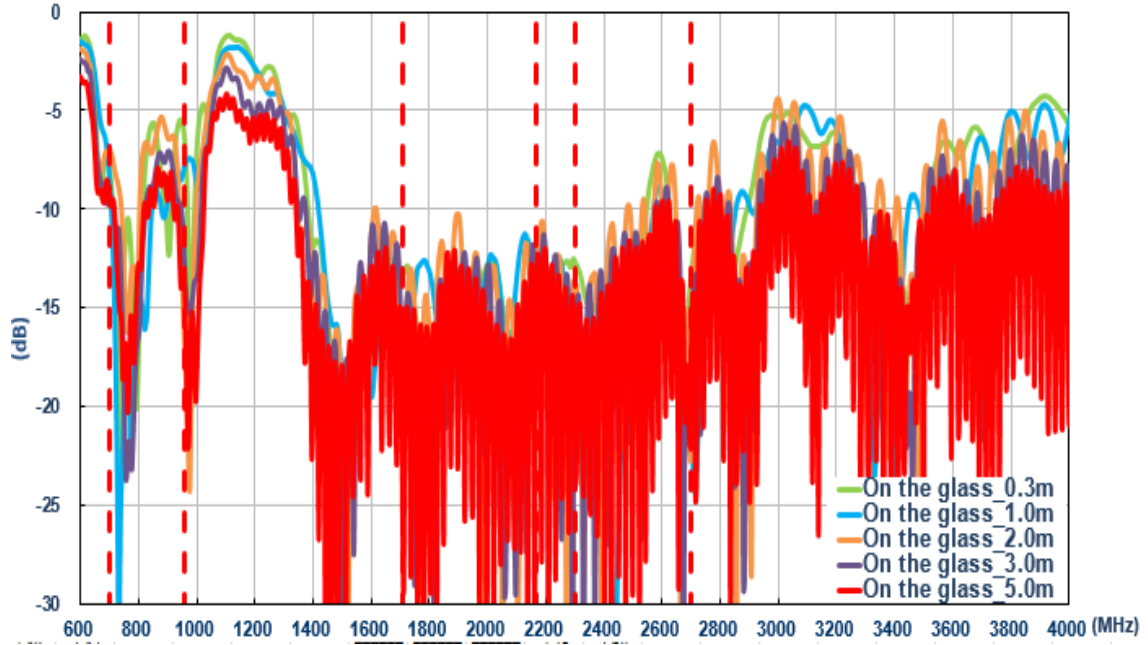

6.5.2. Return Loss (LTE_MIMO_2)

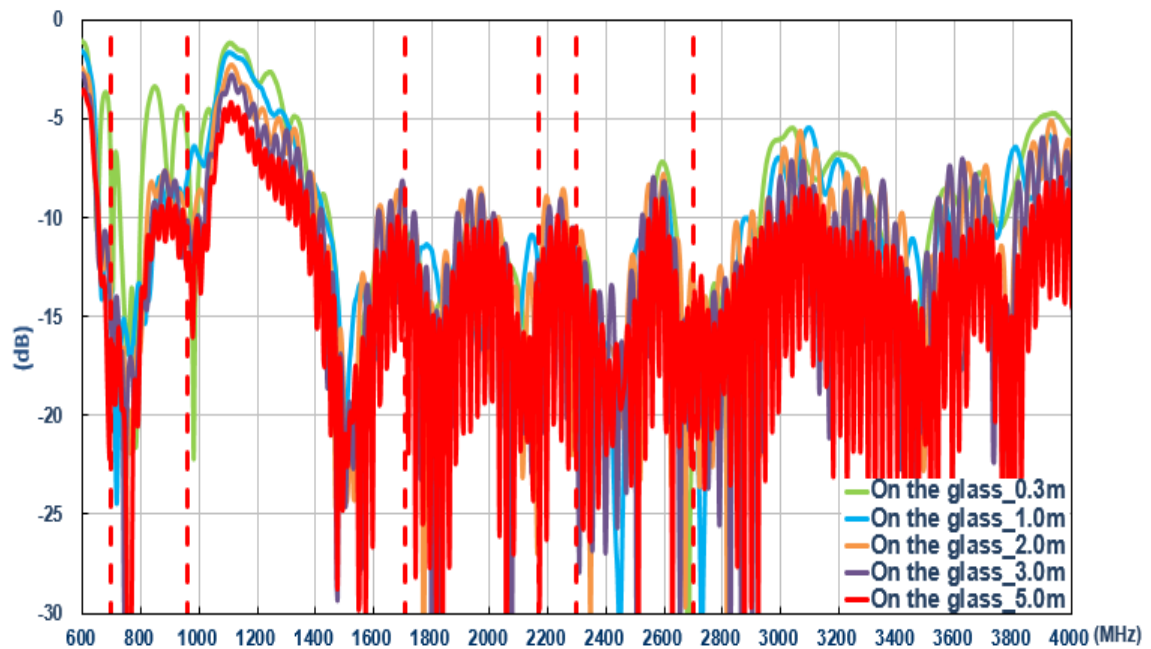

6.5.3. Isolation (LTE antenna)

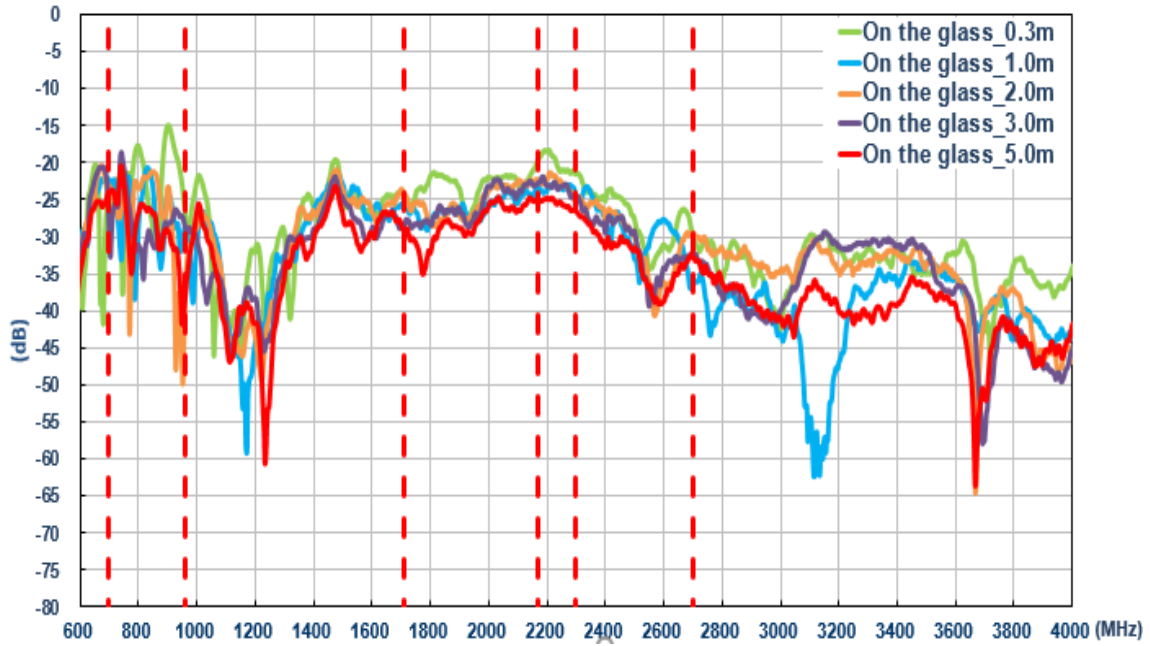

6.5.4. Efficiency (LTE MIMO_1)

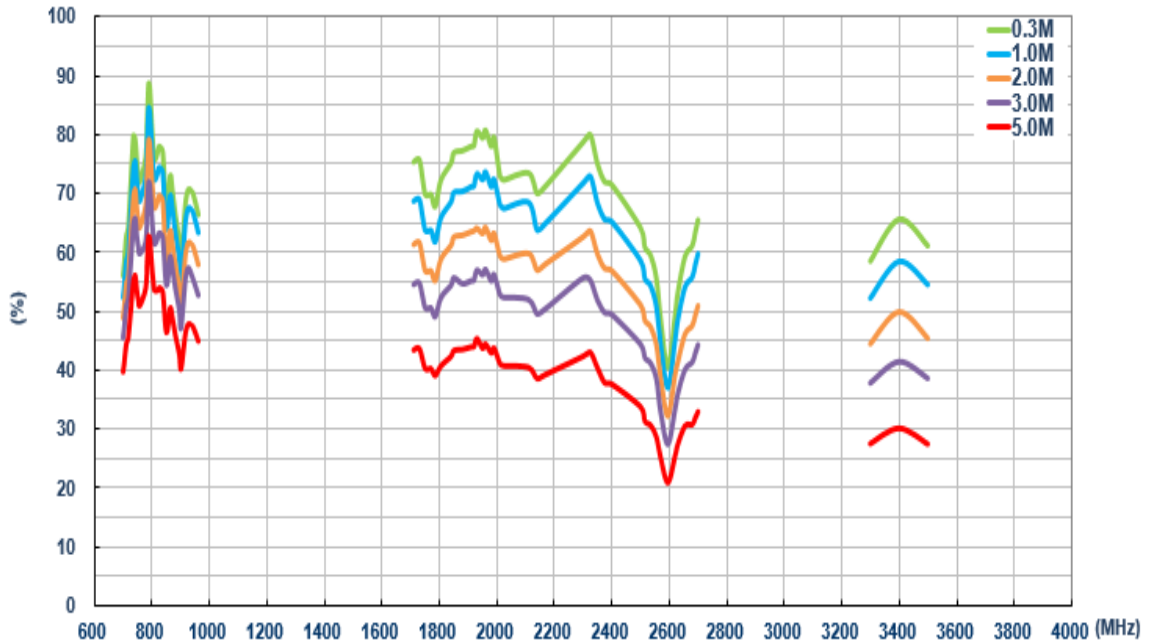

6.5.5. Efficiency (LTE MIMO_2)

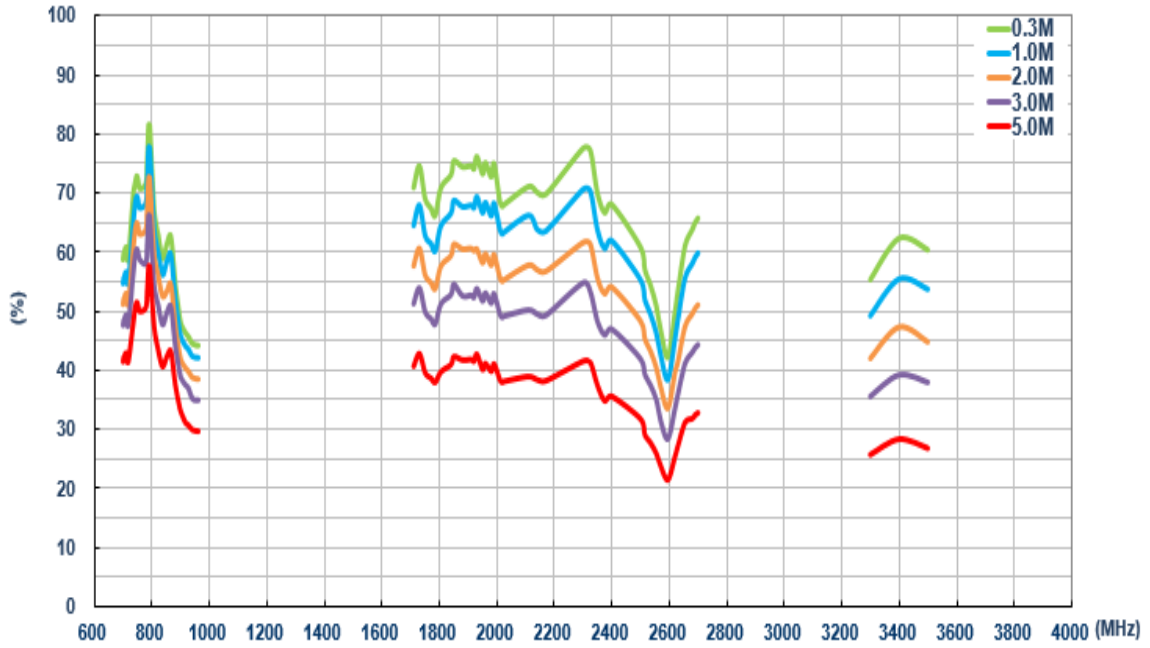

6.5.6. Average Gain (LTE MIMO_1)

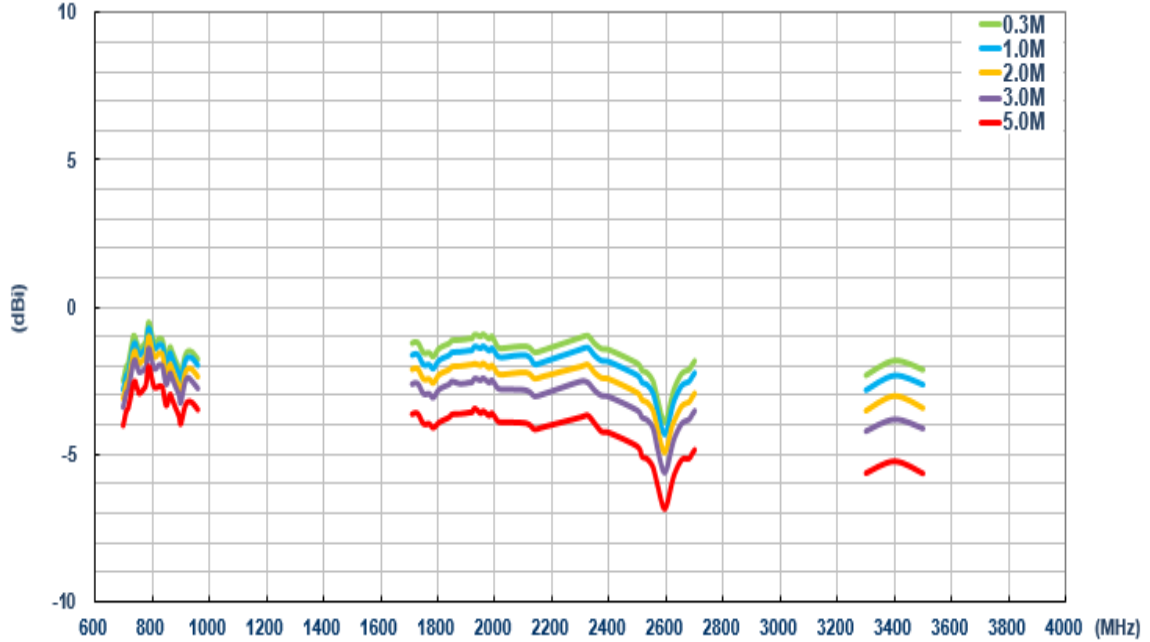

6.5.7. Average Gain (LTE MIMO_2)

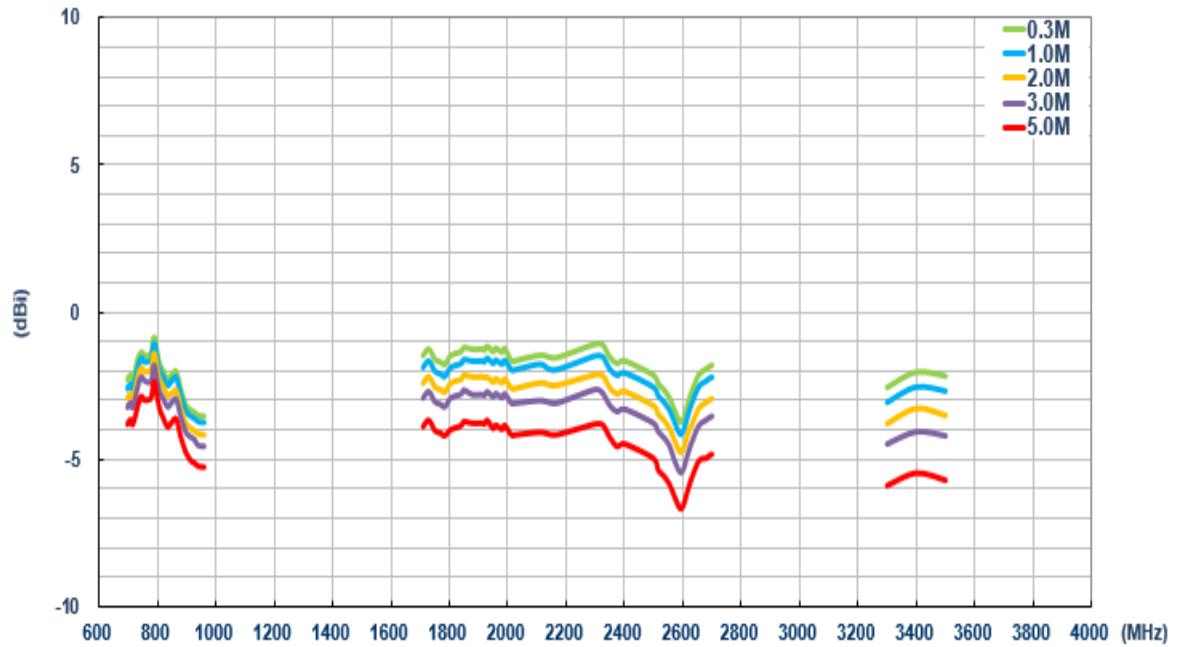

6.5.8. Peak Gain (LTE MIMO_1)

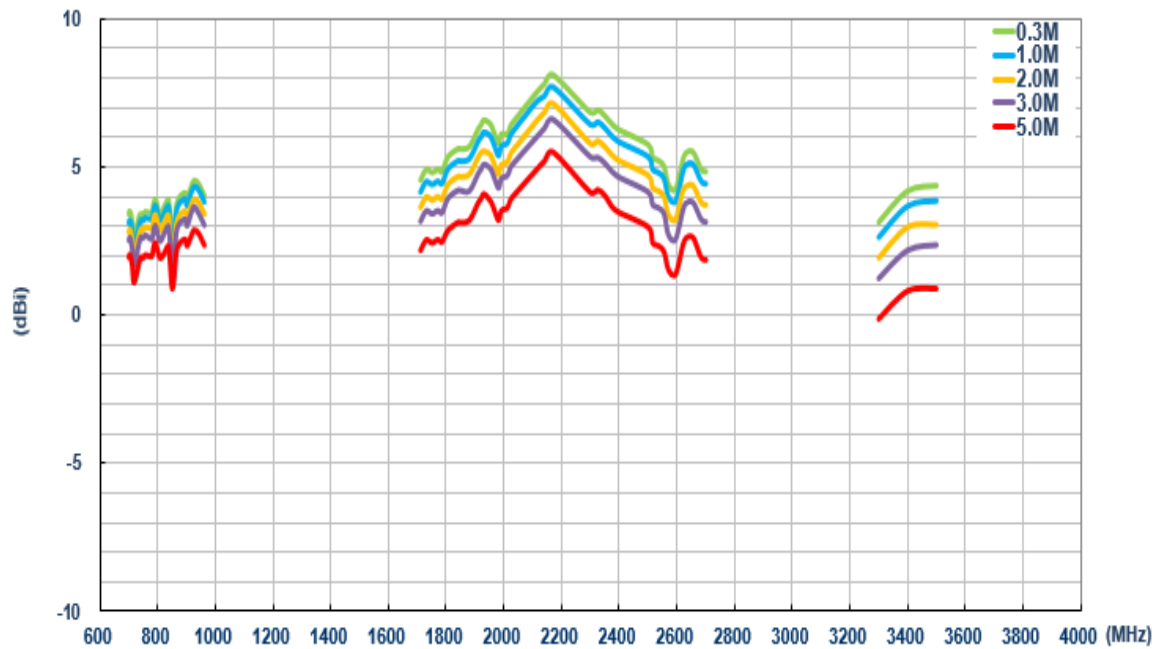

6.5.9. Peak Gain (LTE MIMO_2)

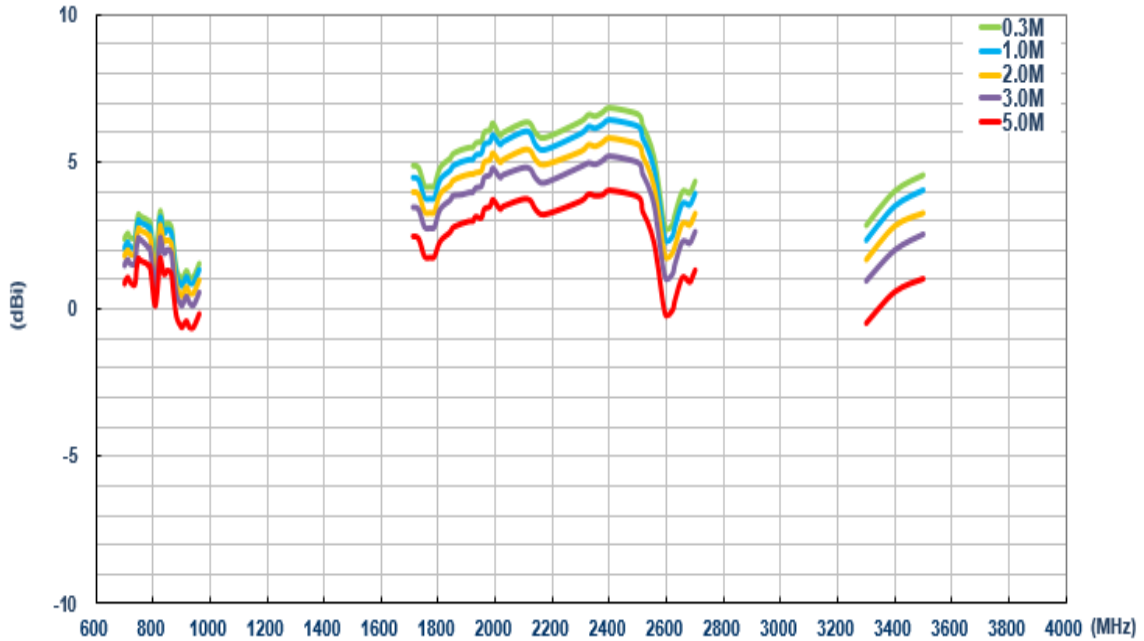

6.6. On glass (Wi-Fi)

6.6.1. Return Loss (Wi-Fi _MIMO_1)

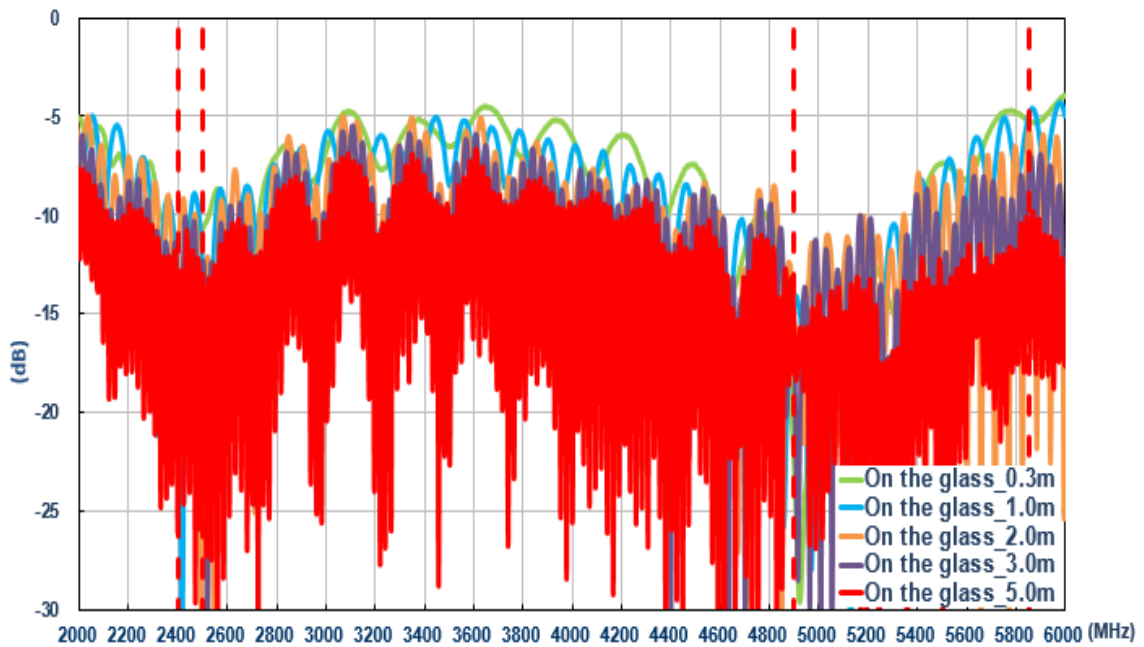

6.6.2. Return Loss (Wi-Fi _MIMO_2)

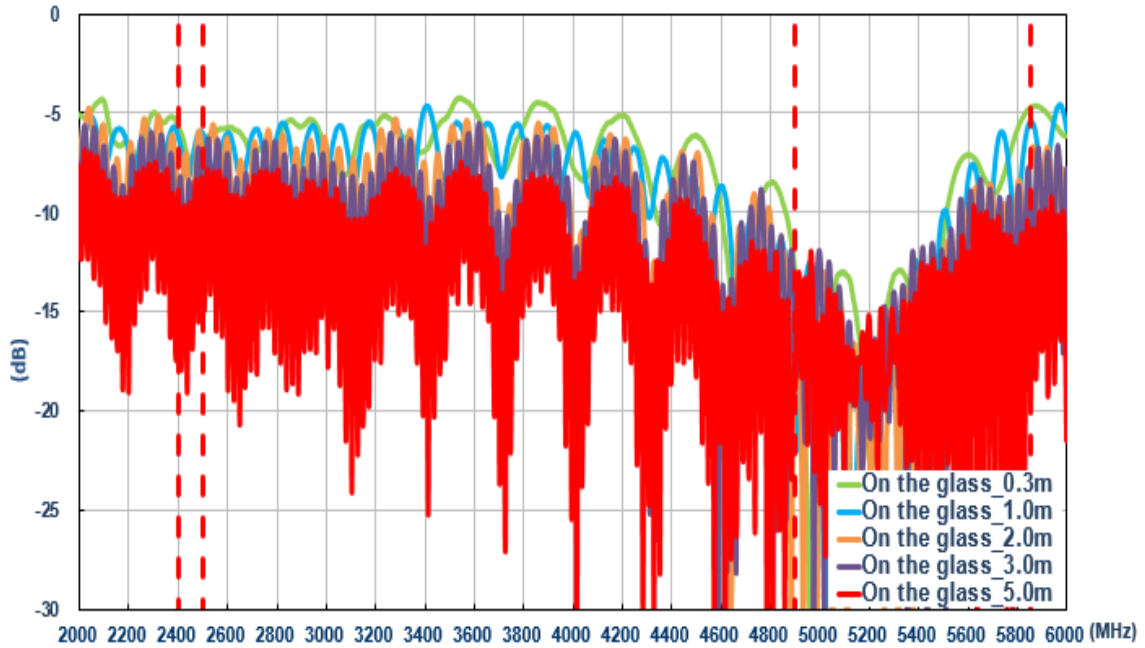

6.6.3. Isolation (Wi-Fi)

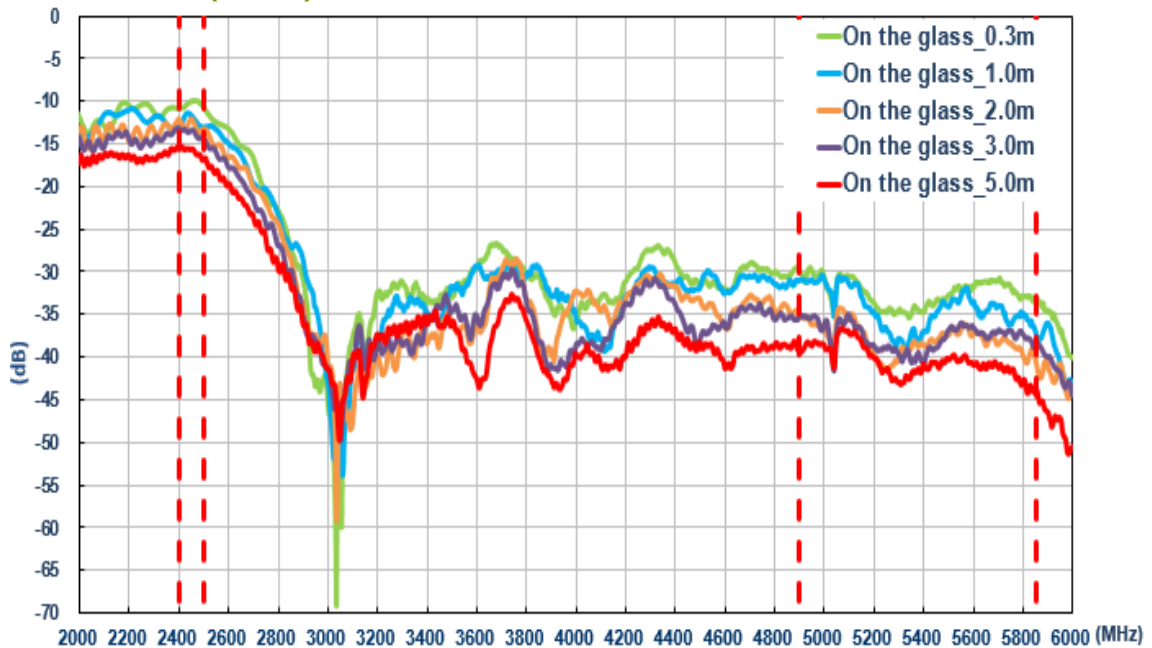

6.6.4. Efficiency (Wi-Fi_MIMO_1)

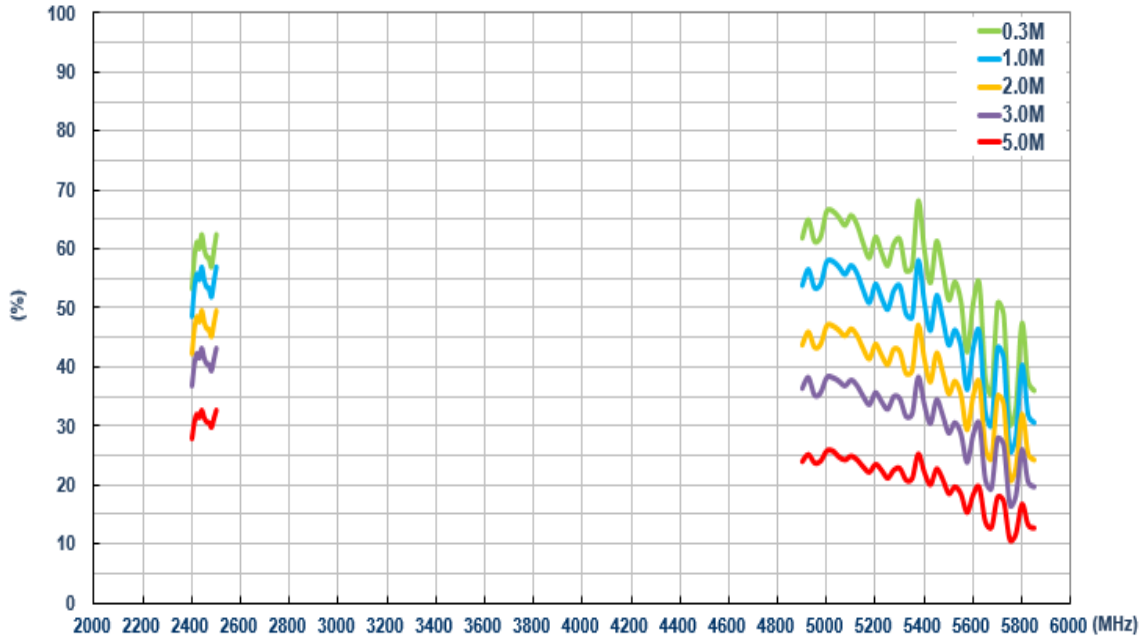

6.6.5. Efficiency (Wi-Fi_MIMO_2)

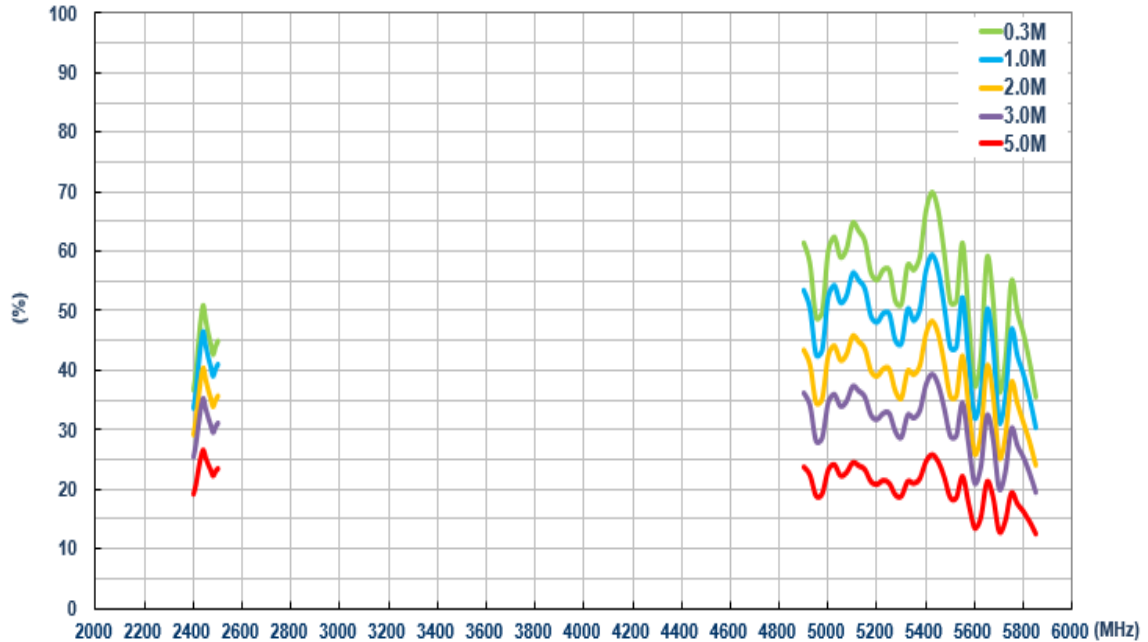

6.6.6. Average Gain (Wi-Fi_MIMO_1)

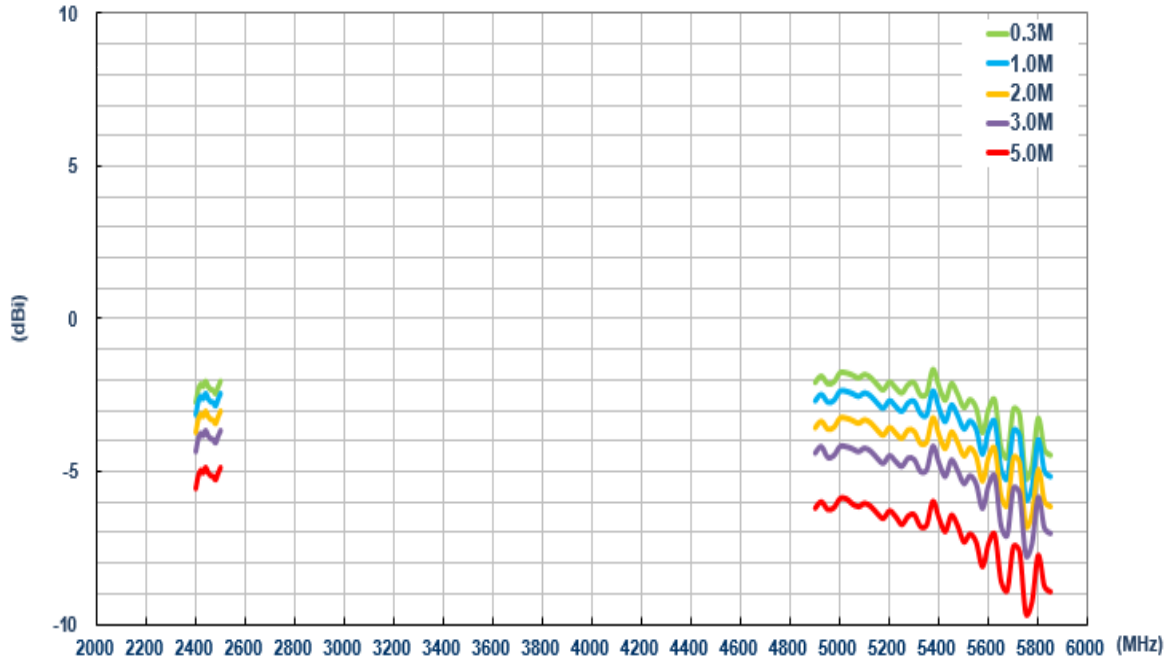

6.6.7. Average Gain (Wi-Fi_MIMO_2)

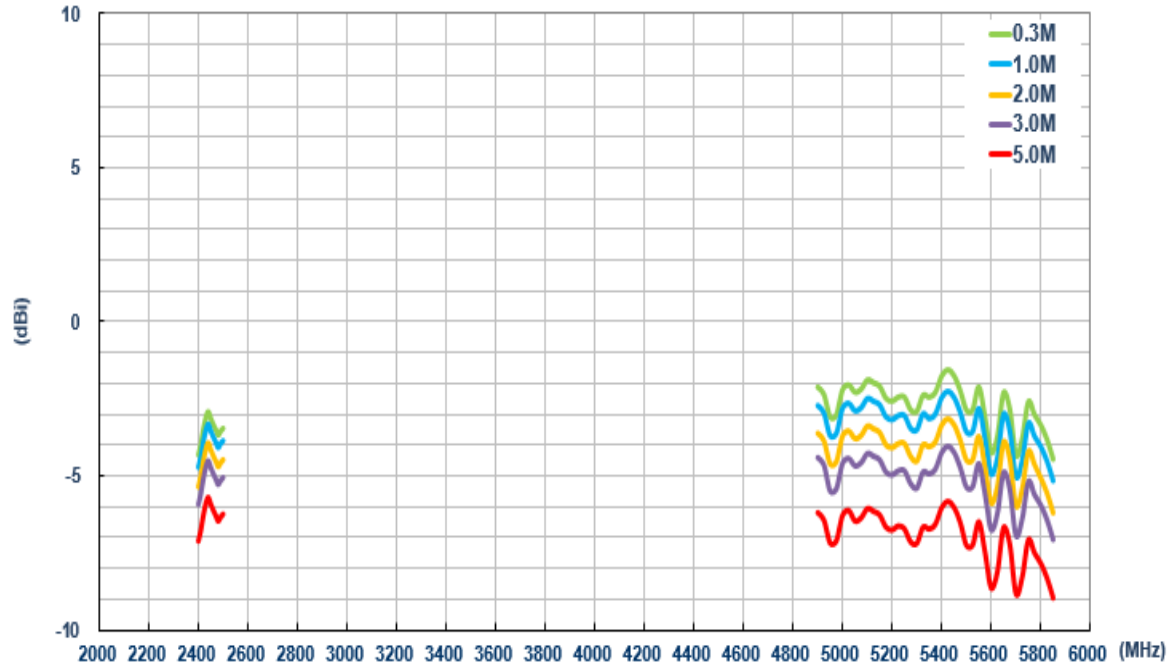

6.6.8. Peak Gain (Wi-Fi _MIMO_1)

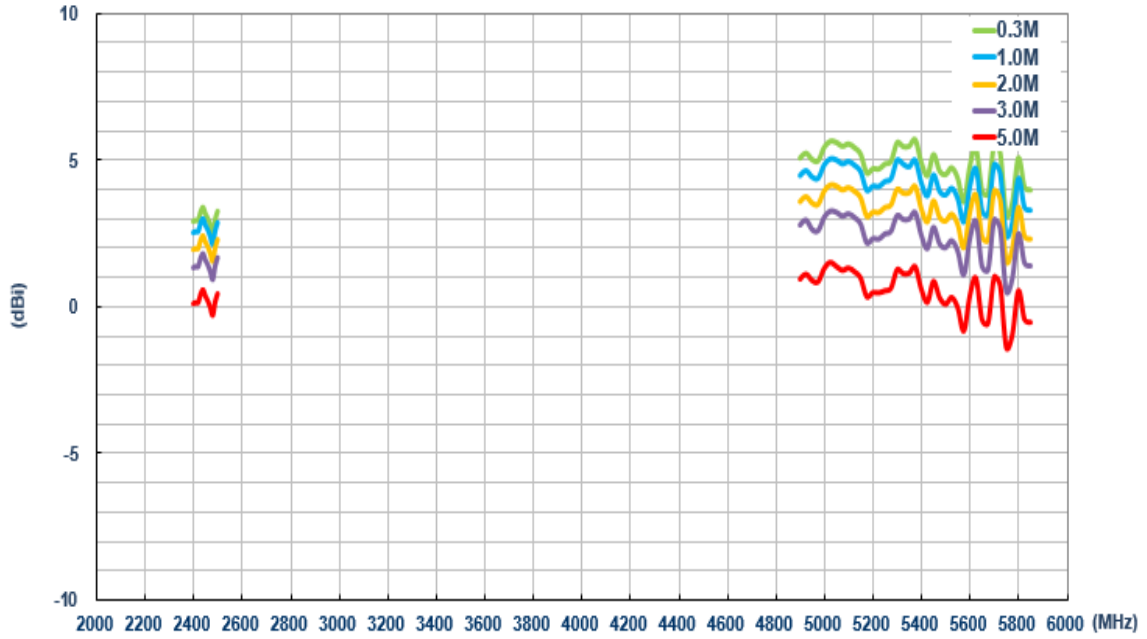

6.6.9. Peak Gain (Wi-Fi _MIMO_2)

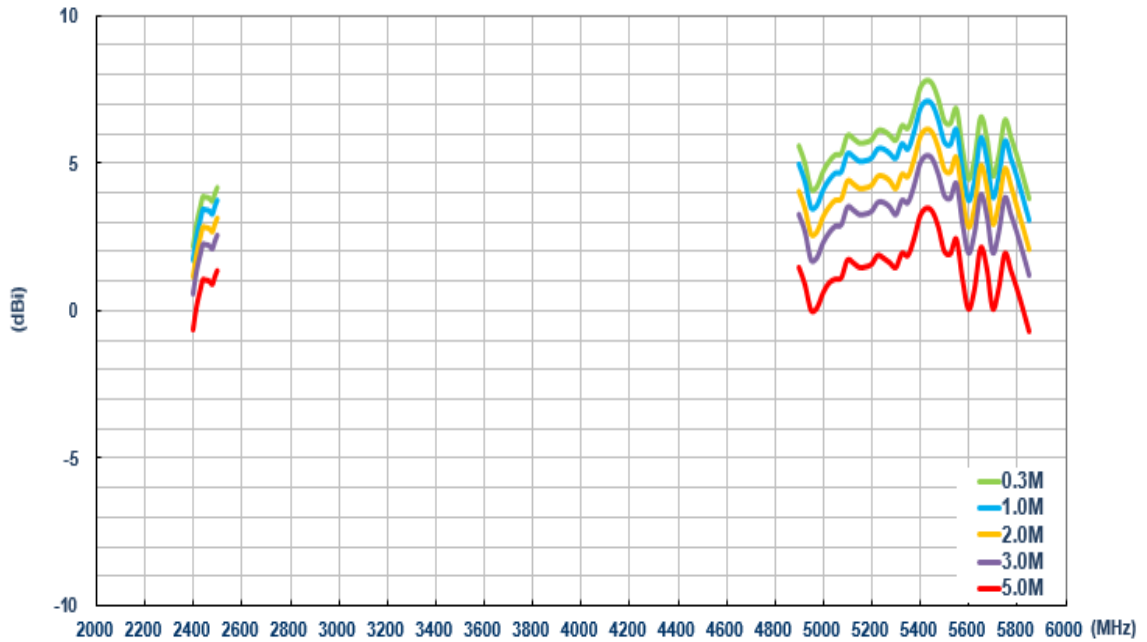

6.7. On metal (LTE)

6.7.1. Return Loss (LTE_MIMO_1)

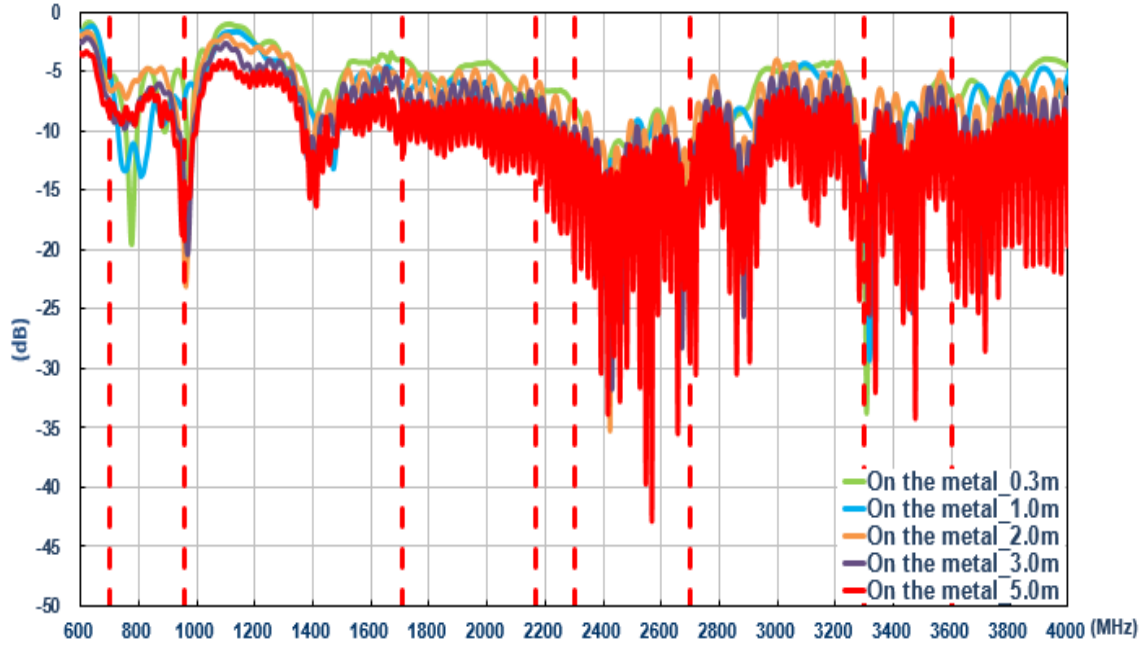

6.7.2. Return Loss (LTE_MIMO_2)

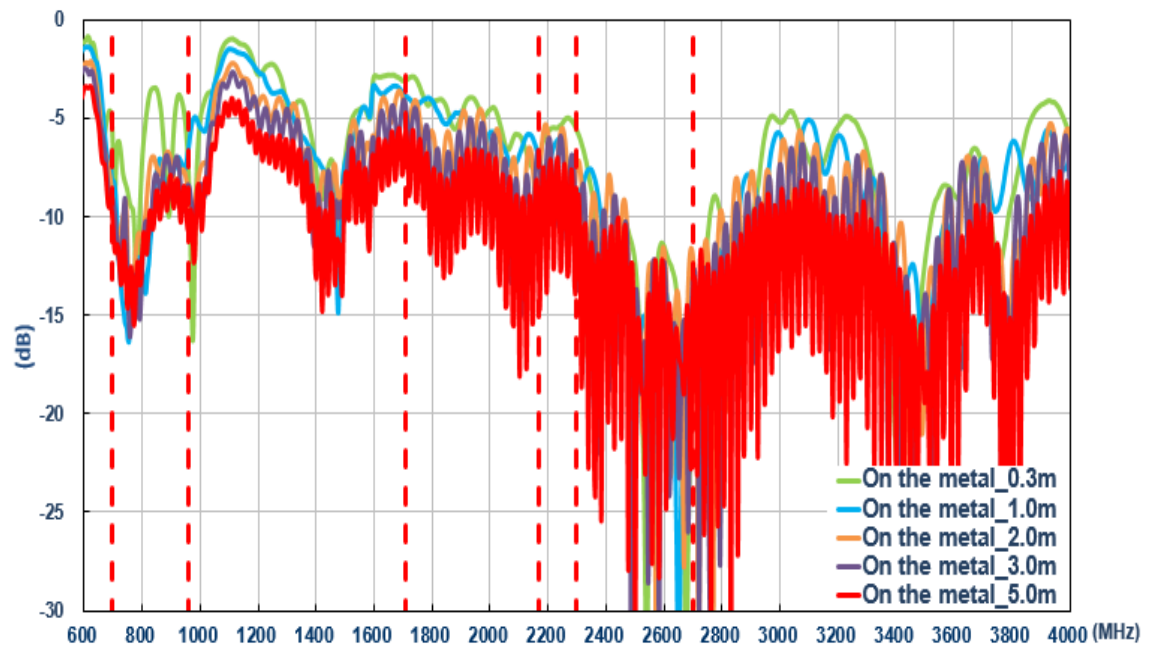

6.7.3. Isolation (LTE antenna)

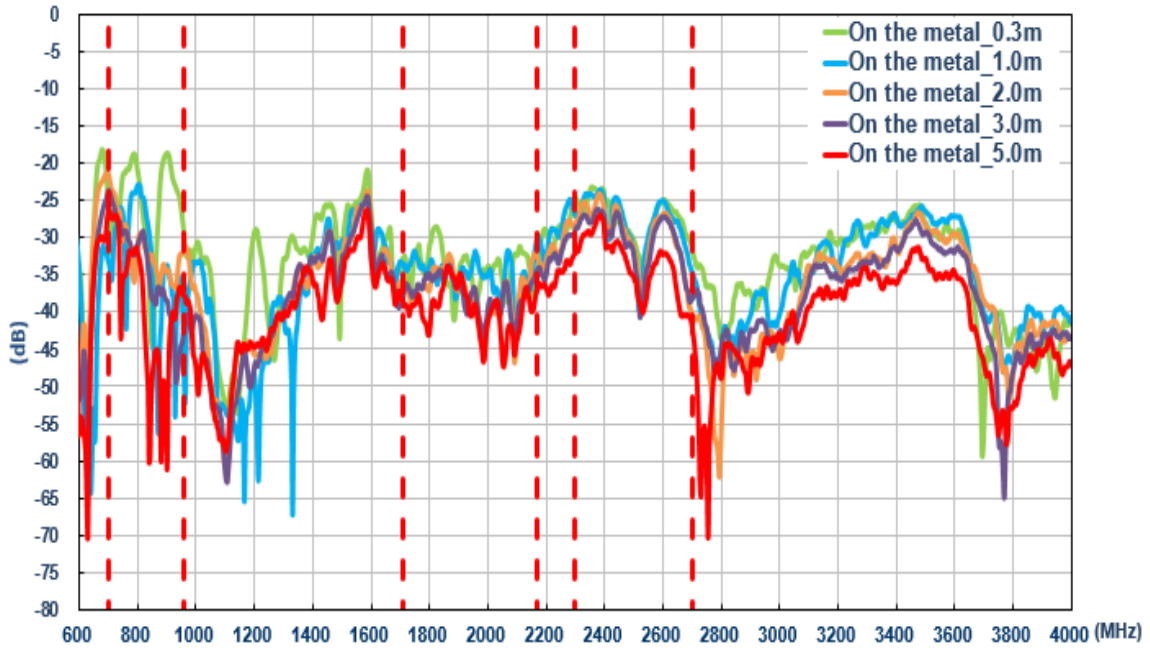

6.7.4. Efficiency (LTE_MIMO_1)

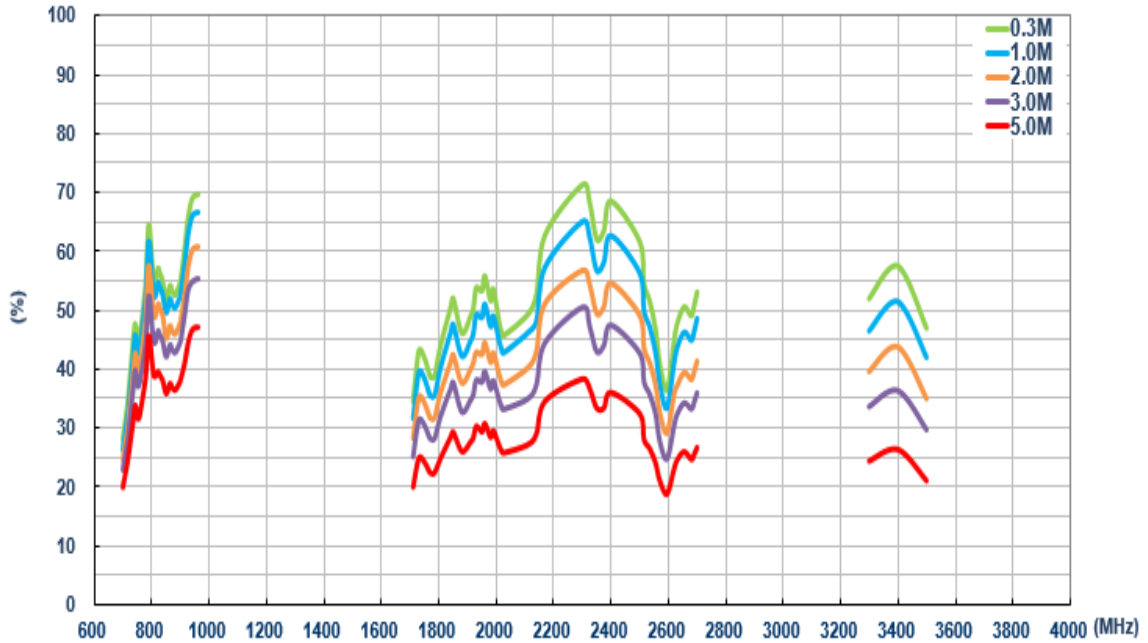

6.7.5. Efficiency (LTE_MIMO_2)

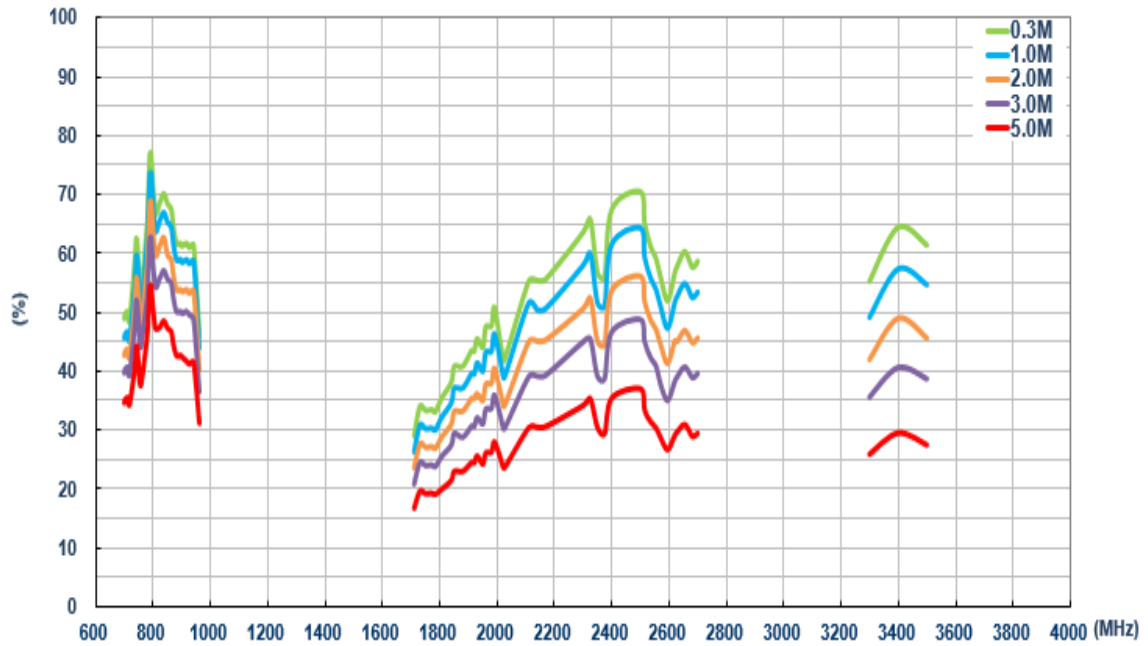

6.7.6. Average Gain (LTE_MIMO_1)

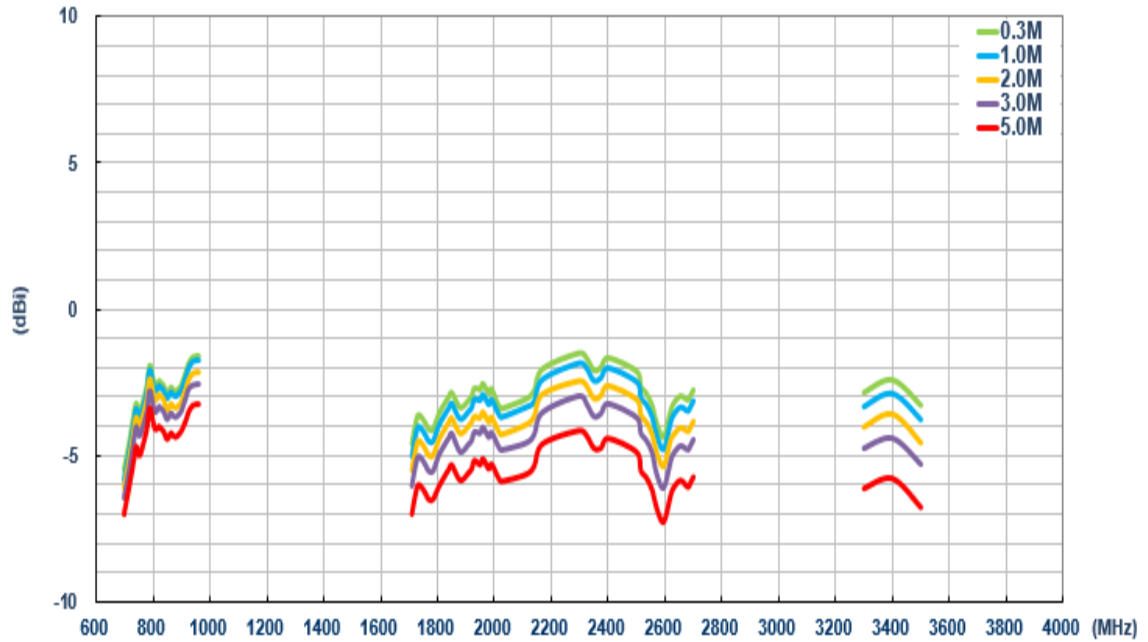

6.7.7. Average Gain (LTE_MIMO_2)

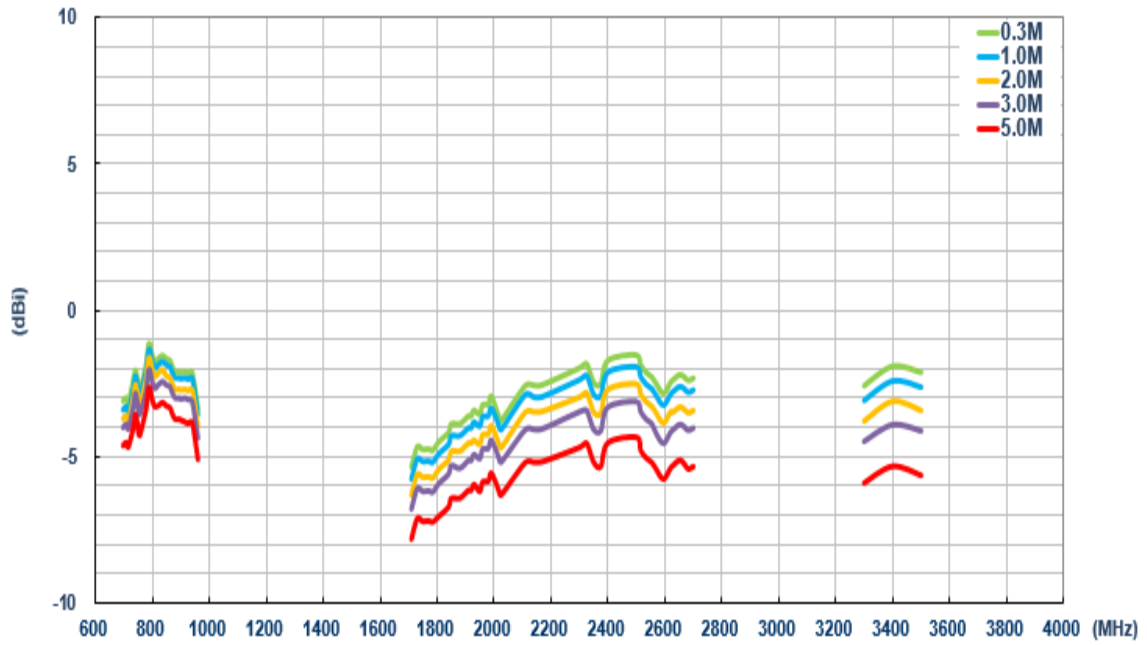

6.7.8. Peak Gain (LTE_MIMO_1)

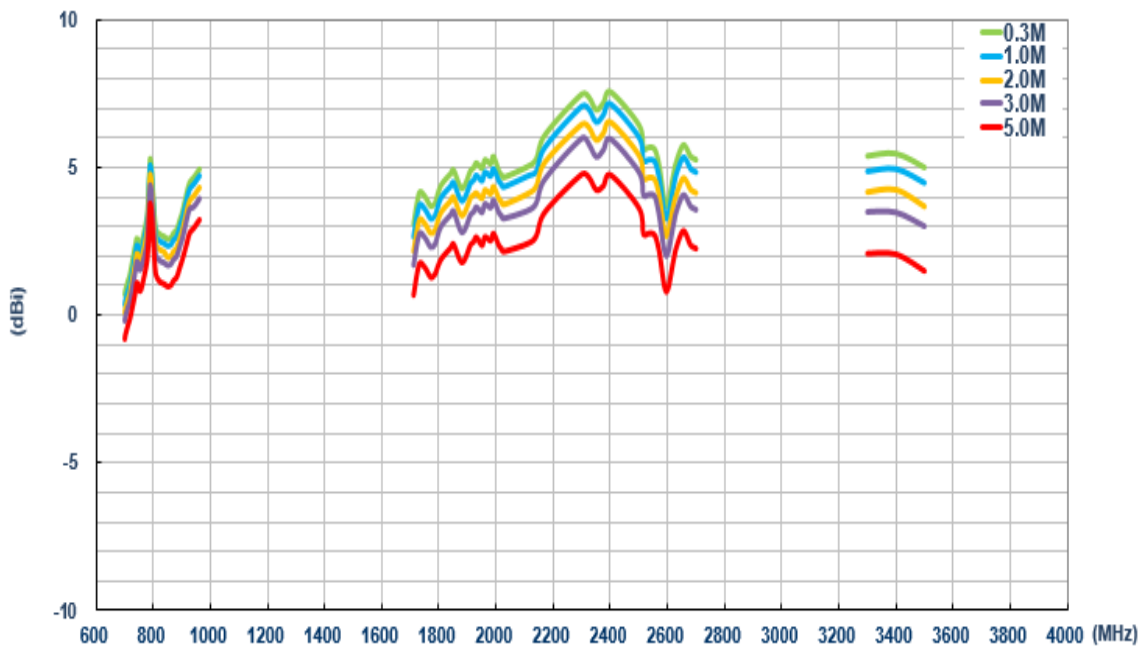

6.7.9. Peak Gain (LTE_MIMO_2)

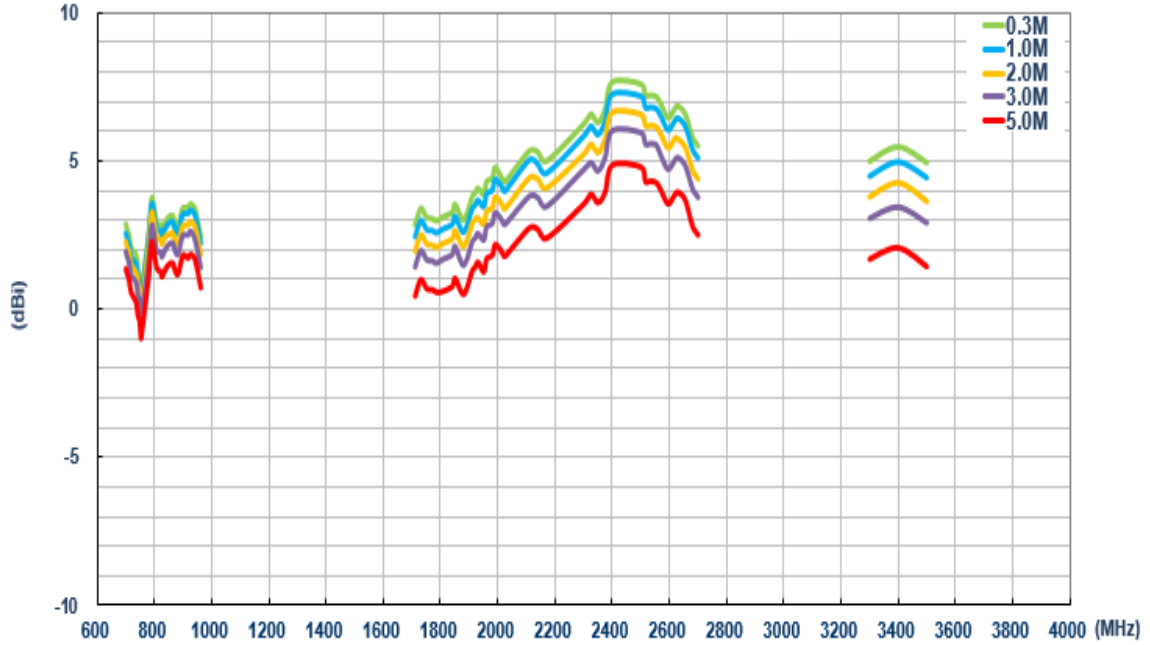

6.8. On metal (Wi-Fi)

6.8.1. Return Loss (Wi-Fi _MIMO_1)

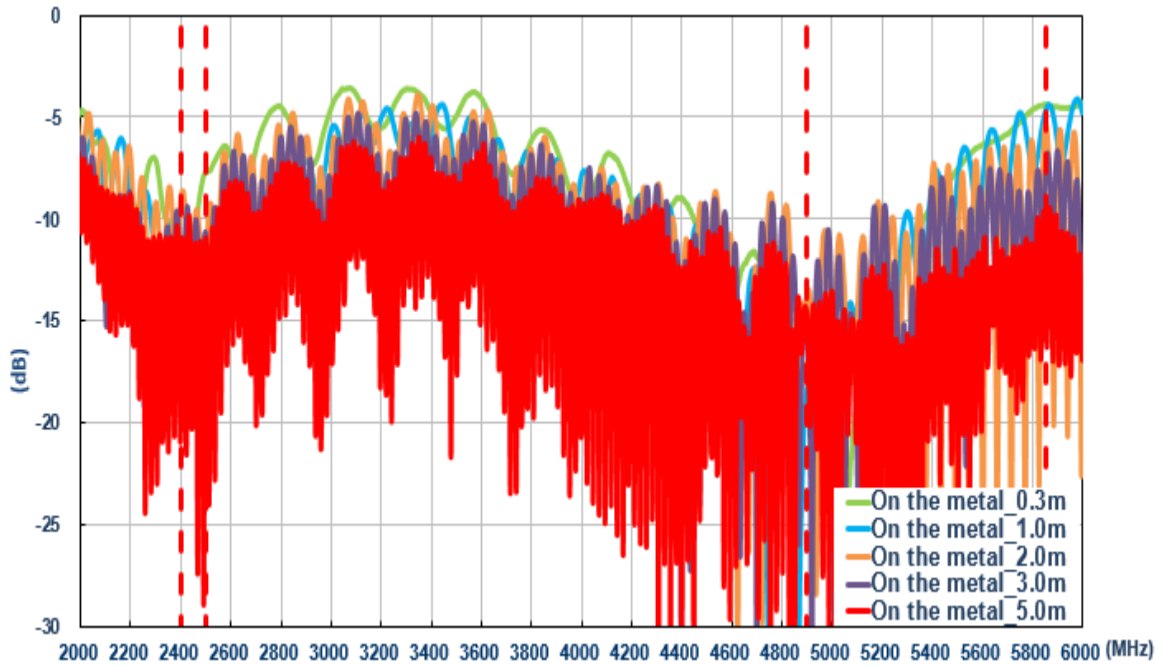

6.8.2. Return Loss (Wi-Fi_MIMO_2)

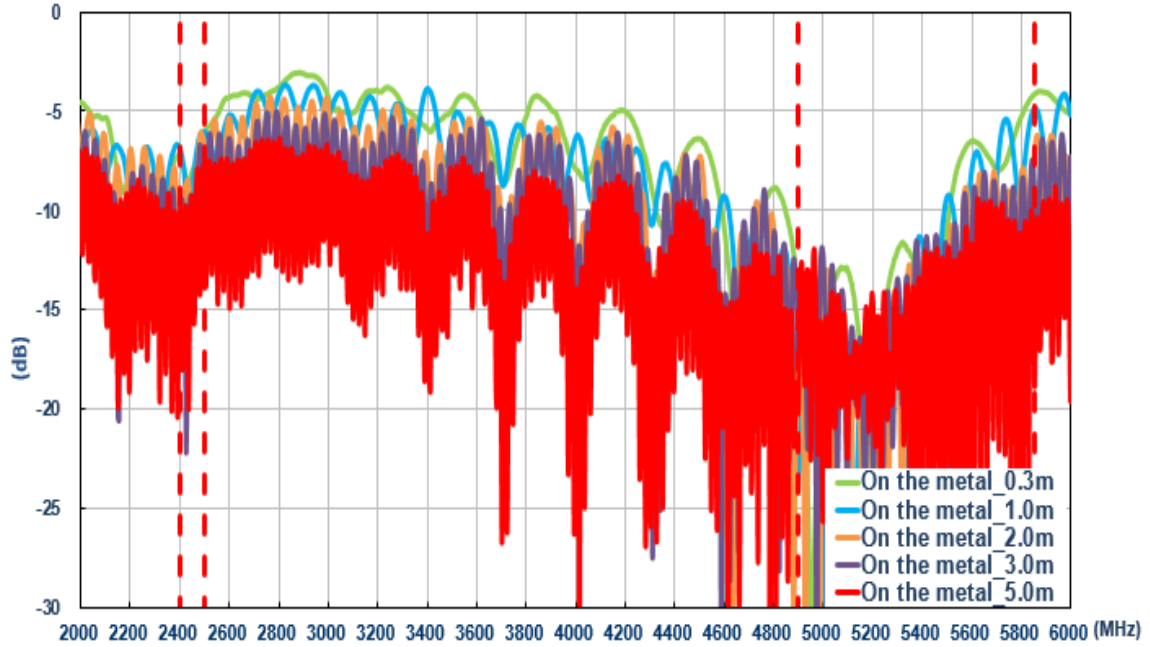

6.8.3. Isolation (Wi-Fi)

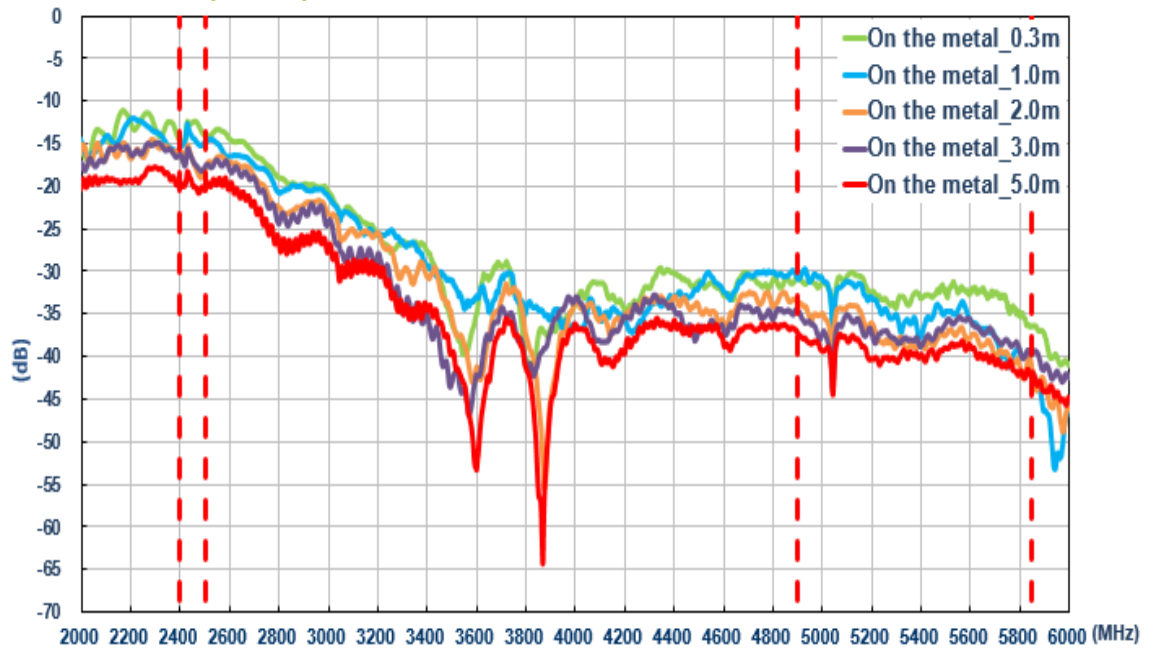

6.8.4. Efficiency (Wi-Fi_MIMO_1)

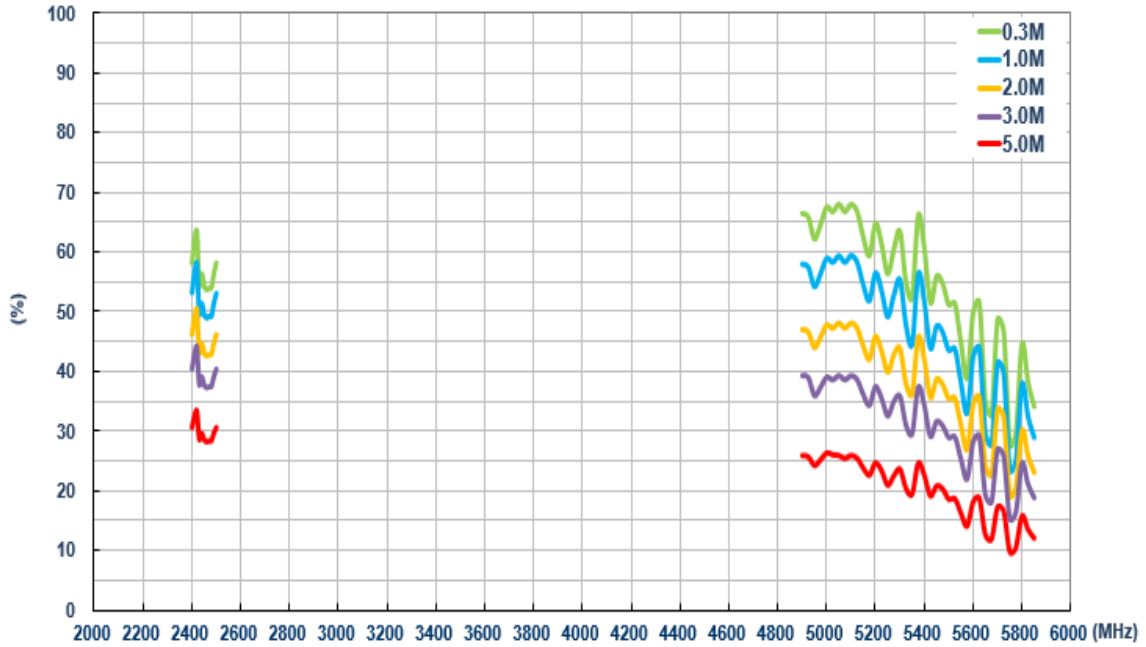

6.8.5. Efficiency (Wi-Fi_MIMO_2)

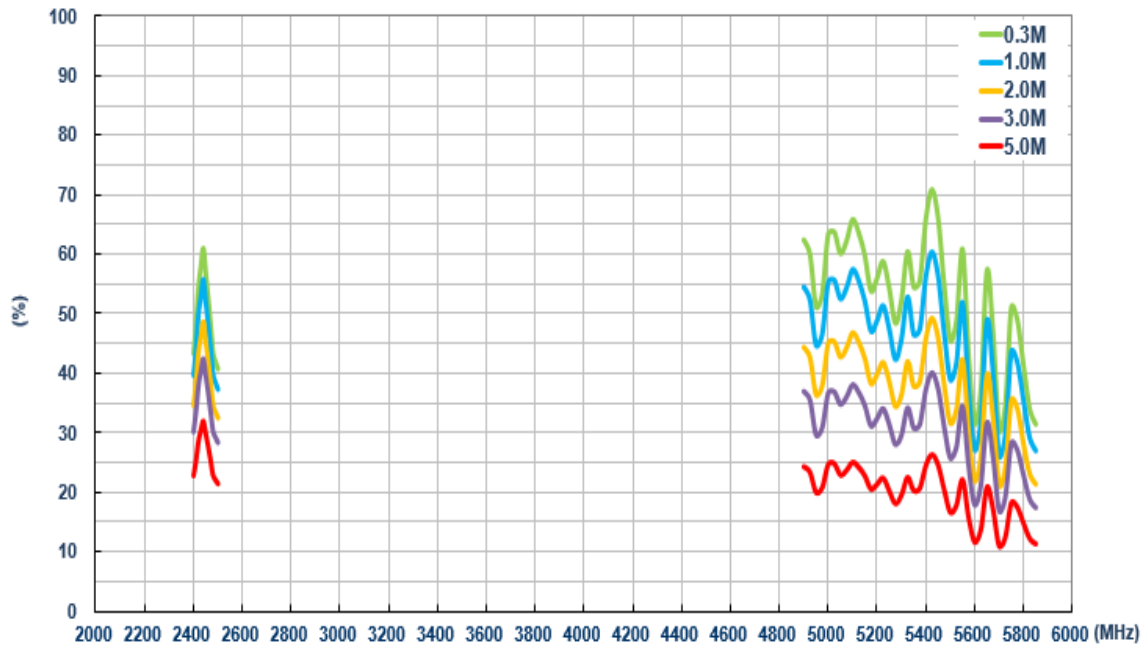

6.8.6. Average Gain (Wi-Fi_MIMO_1)

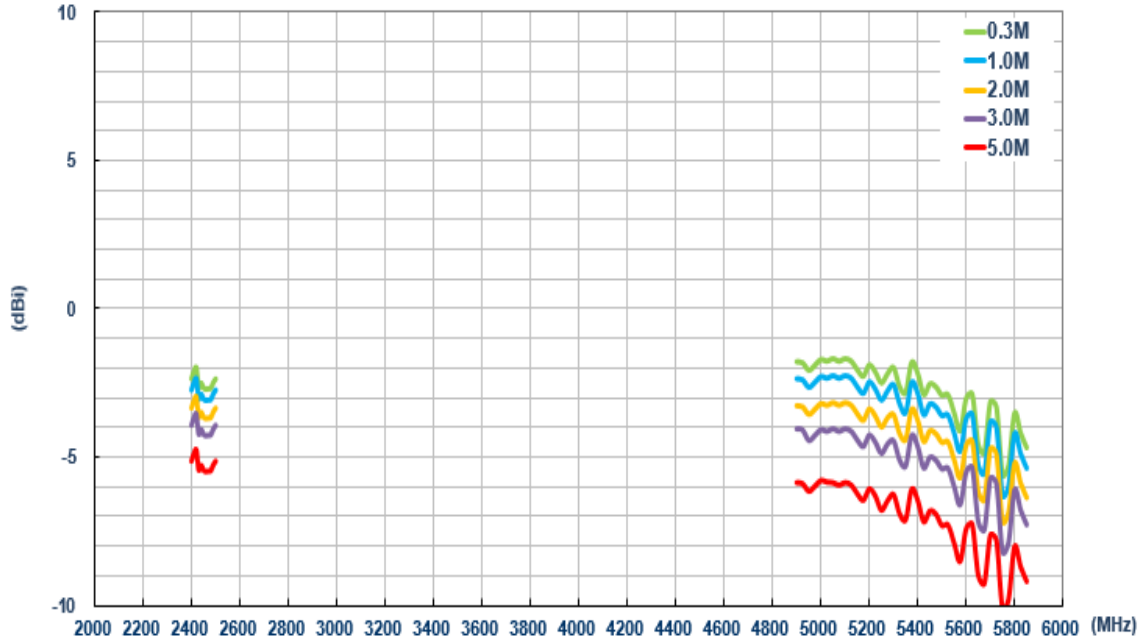

6.8.7. Average Gain (Wi-Fi_MIMO_2)

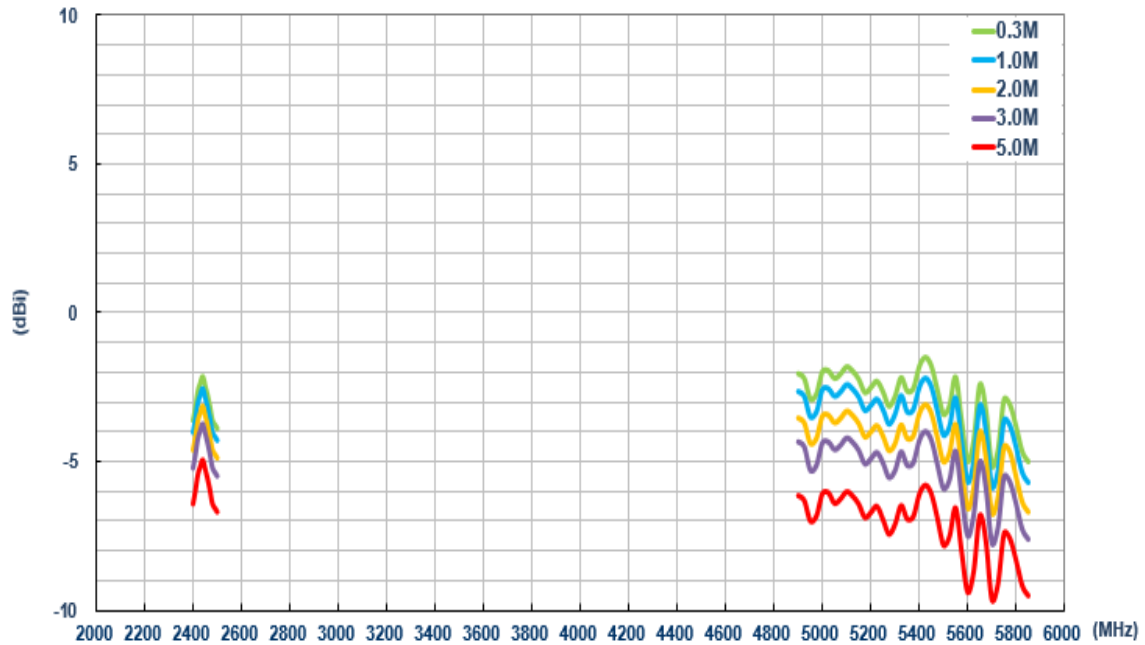

6.8.8. Peak Gain (Wi-Fi_MIMO_1)

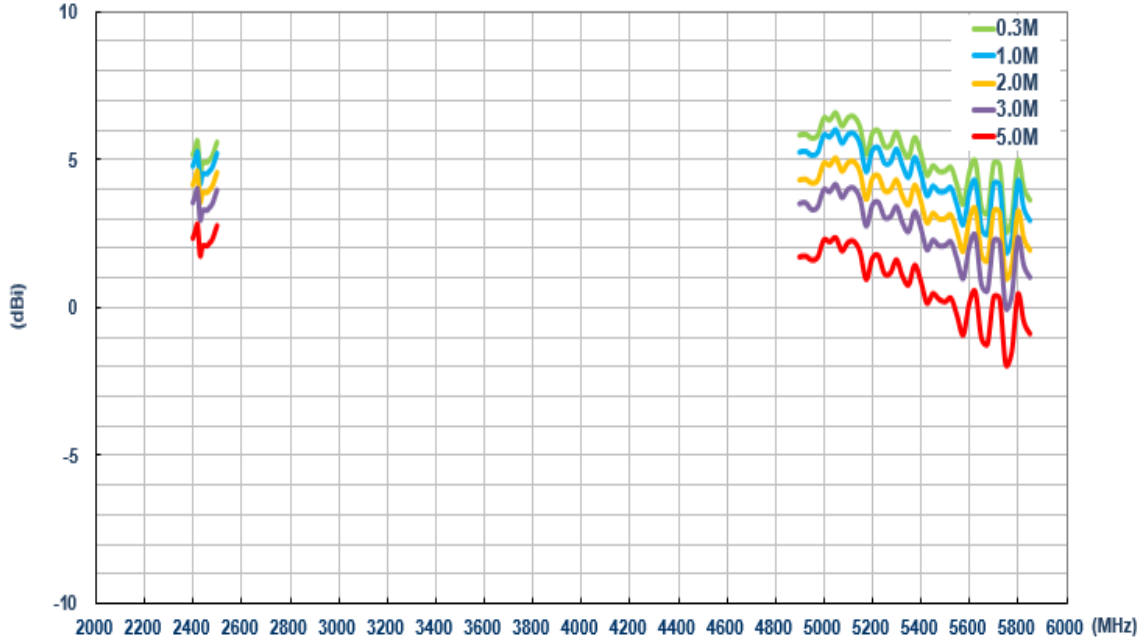

6.8.9. Peak Gain (Wi-Fi_MIMO_2)

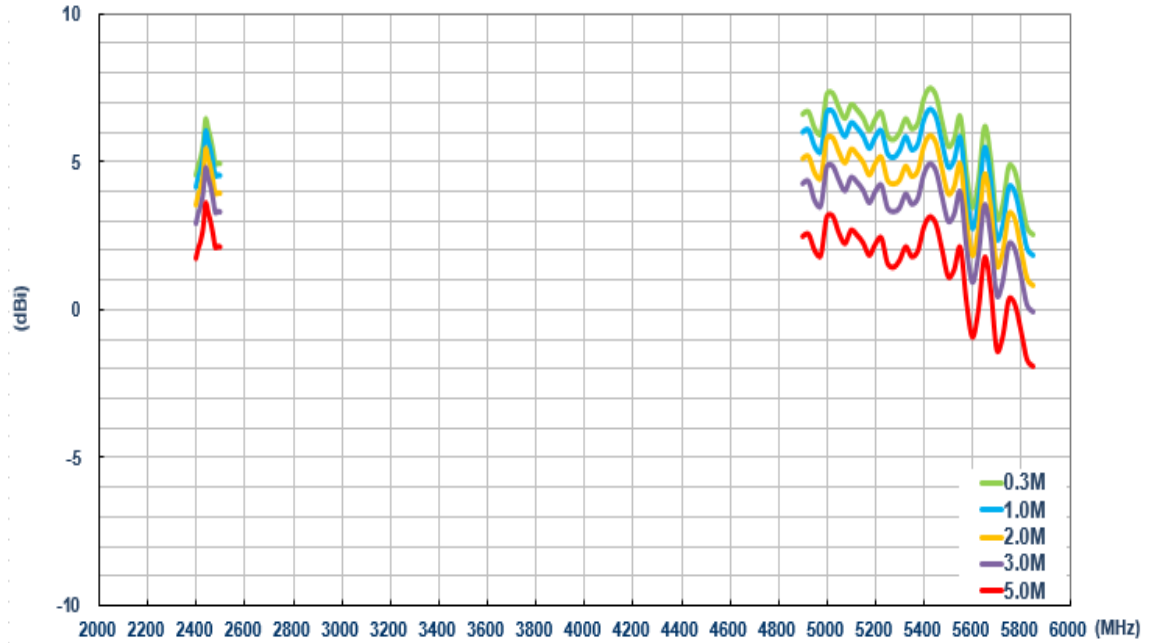

6.9. On the wall (LTE)

6.9.1. Return Loss (LTE_MIMO_1)

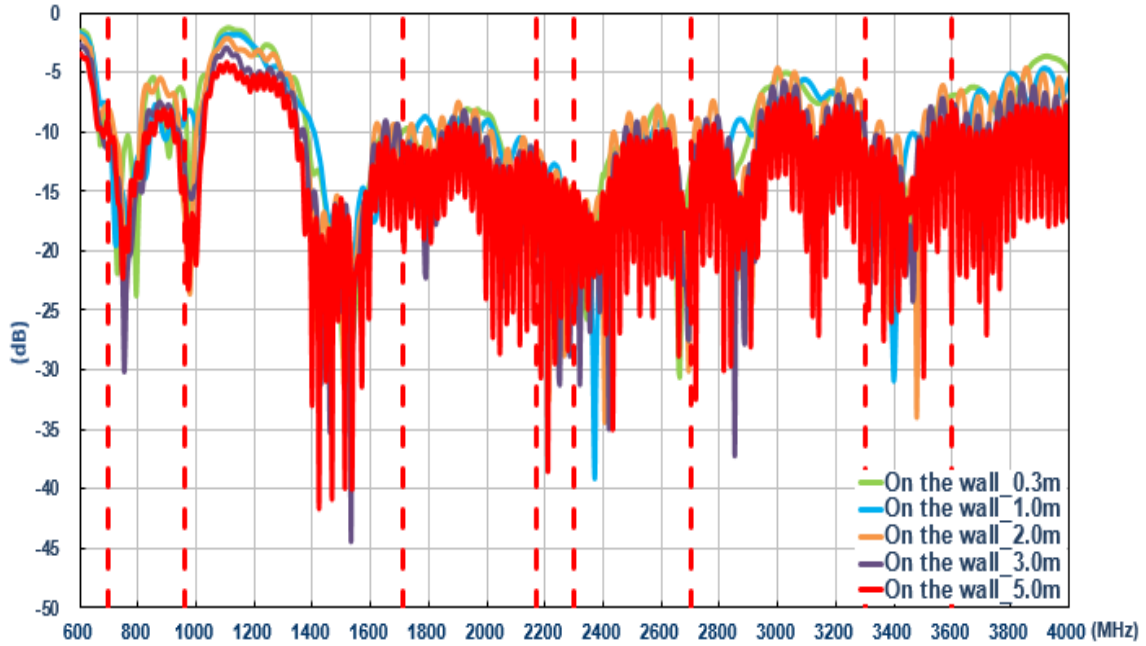

6.9.2. Return Loss (LTE_MIMO_2)

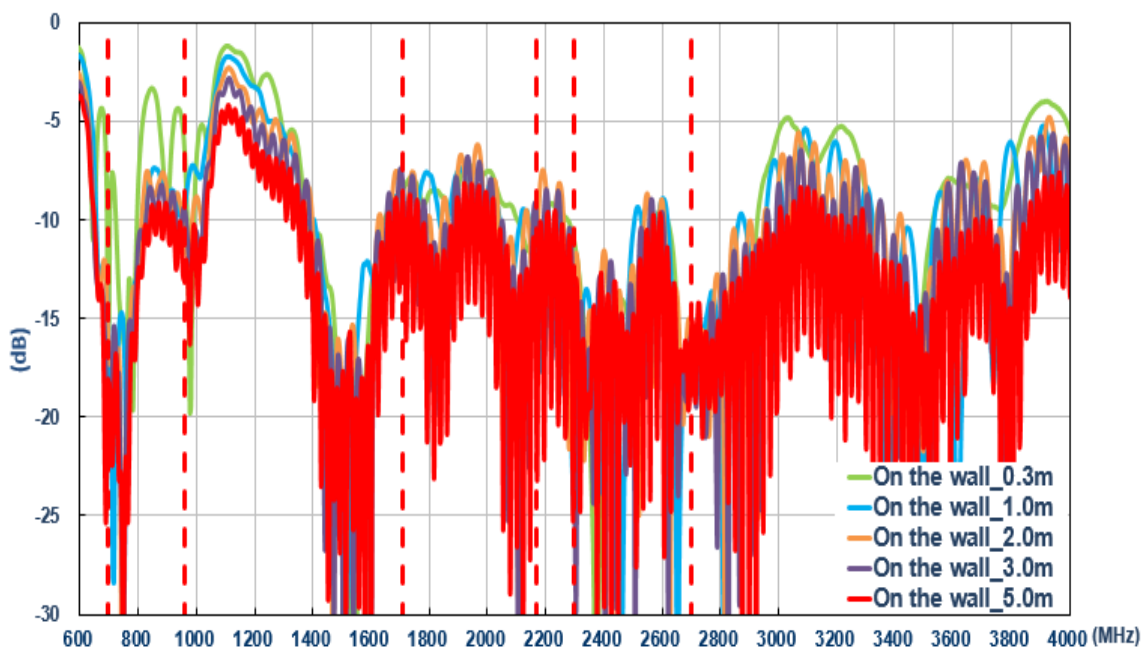

6.9.3. Isolation (LTE antenna)

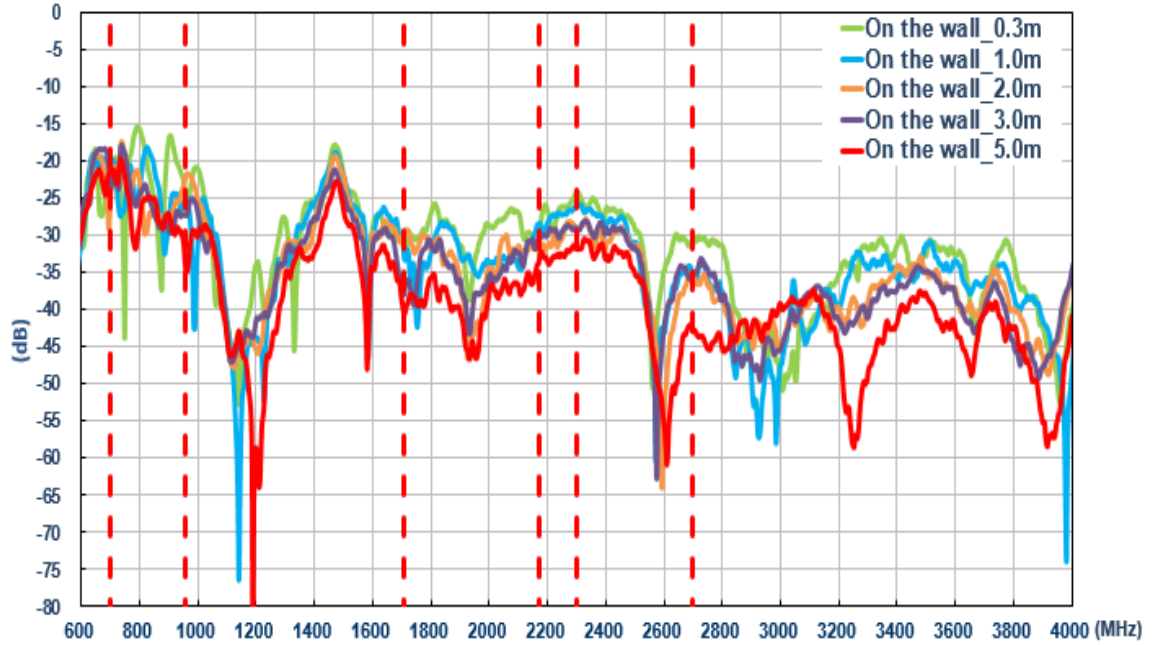

6.9.4. Efficiency (LTE_MIMO_1)

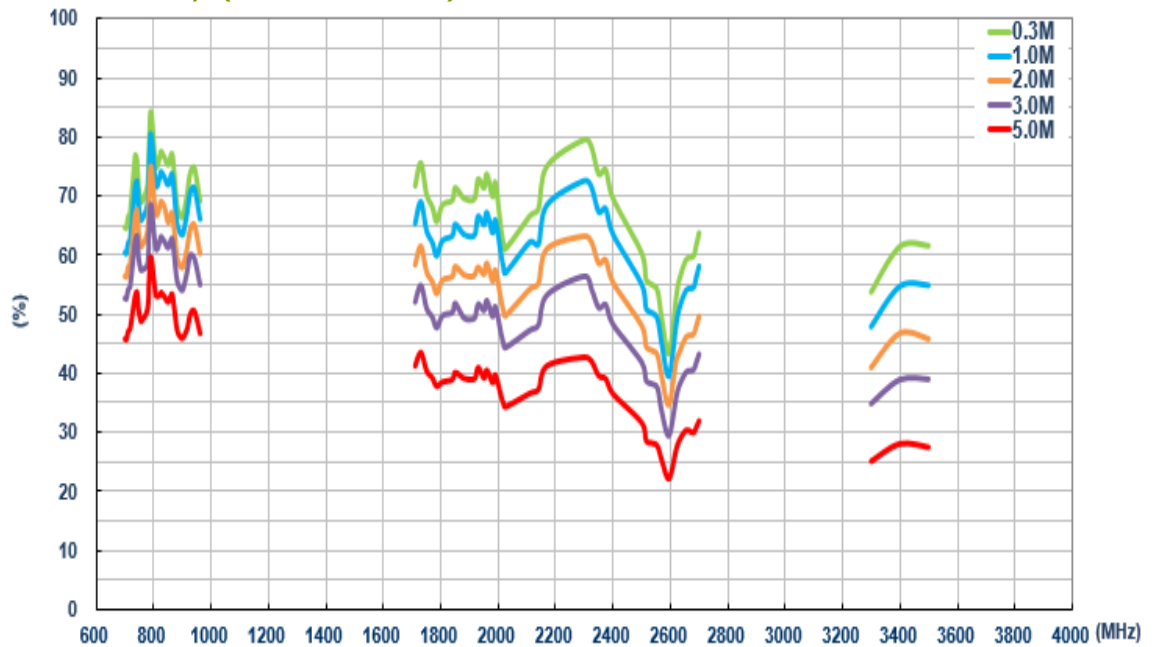

6.9.5. Efficiency (LTE_MIMO_2)

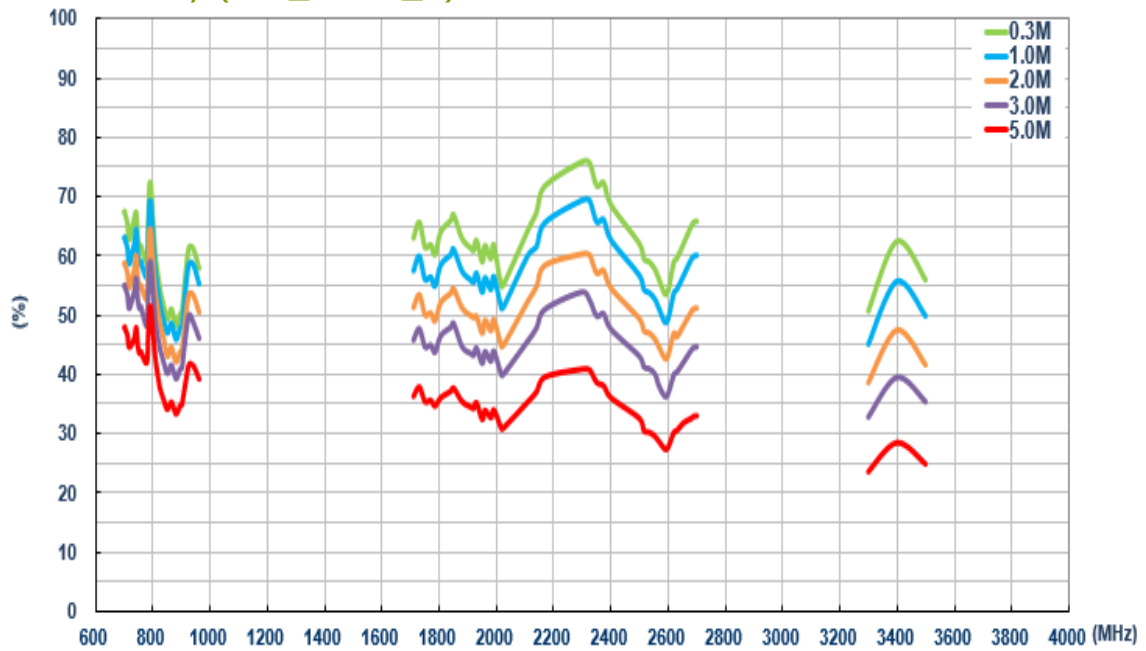

6.9.6. Average Gain (LTE_MIMO_1)

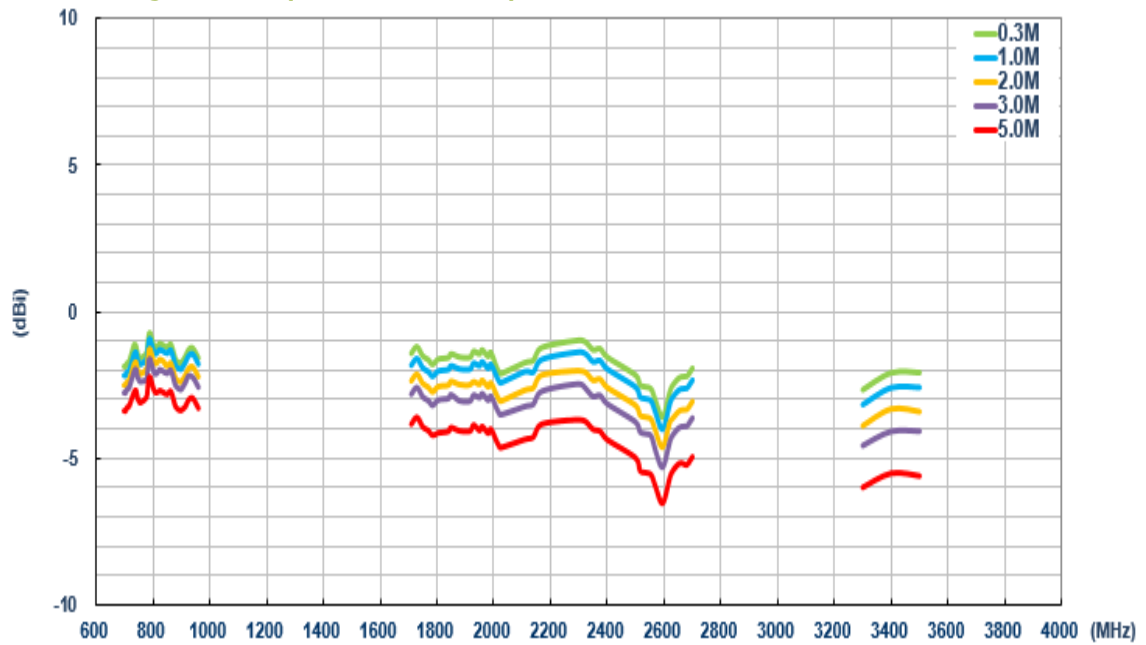

6.9.7. Average Gain (LTE_MIMO_2)

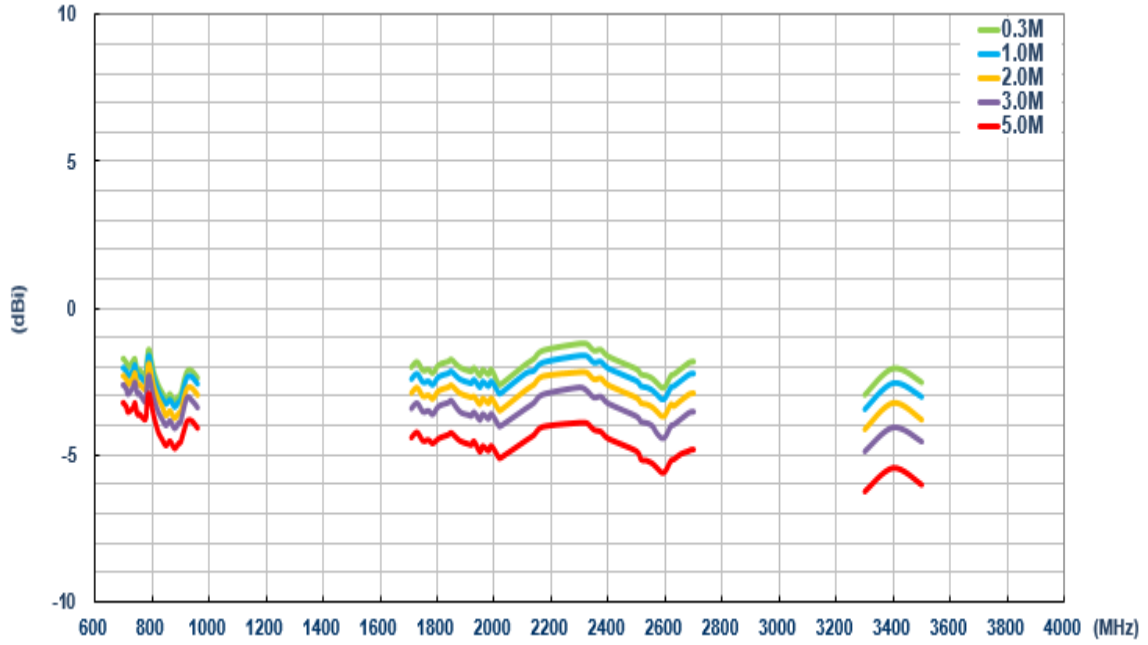

6.9.8. Peak Gain (LTE_MIMO_1)

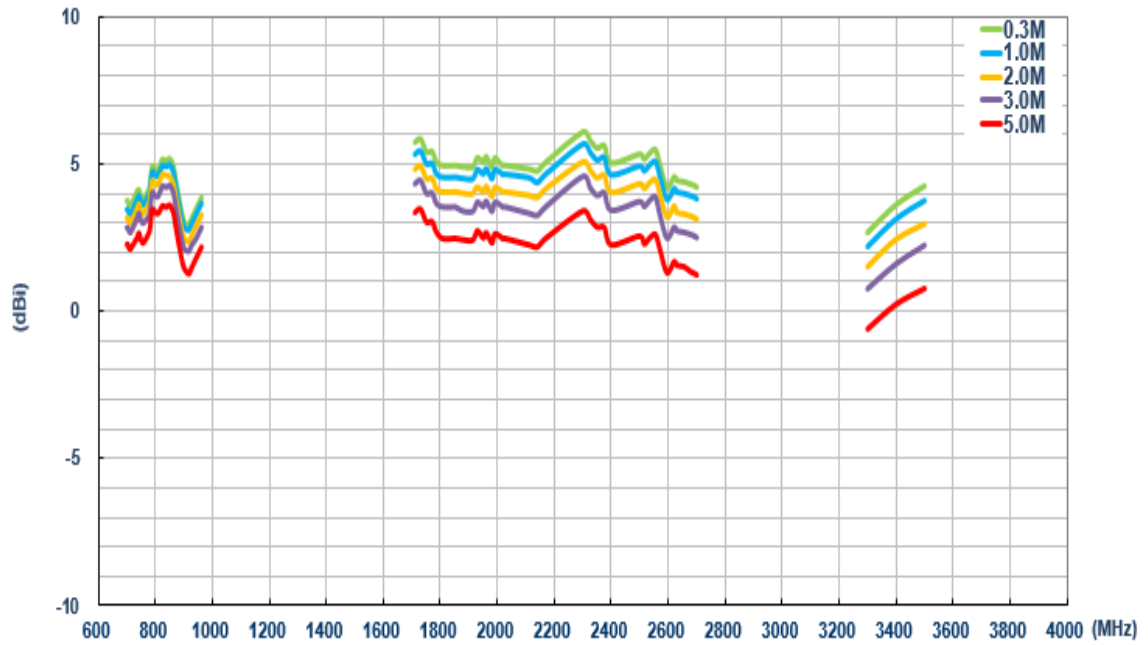

6.9.9. Peak Gain (LTE_MIMO_2)

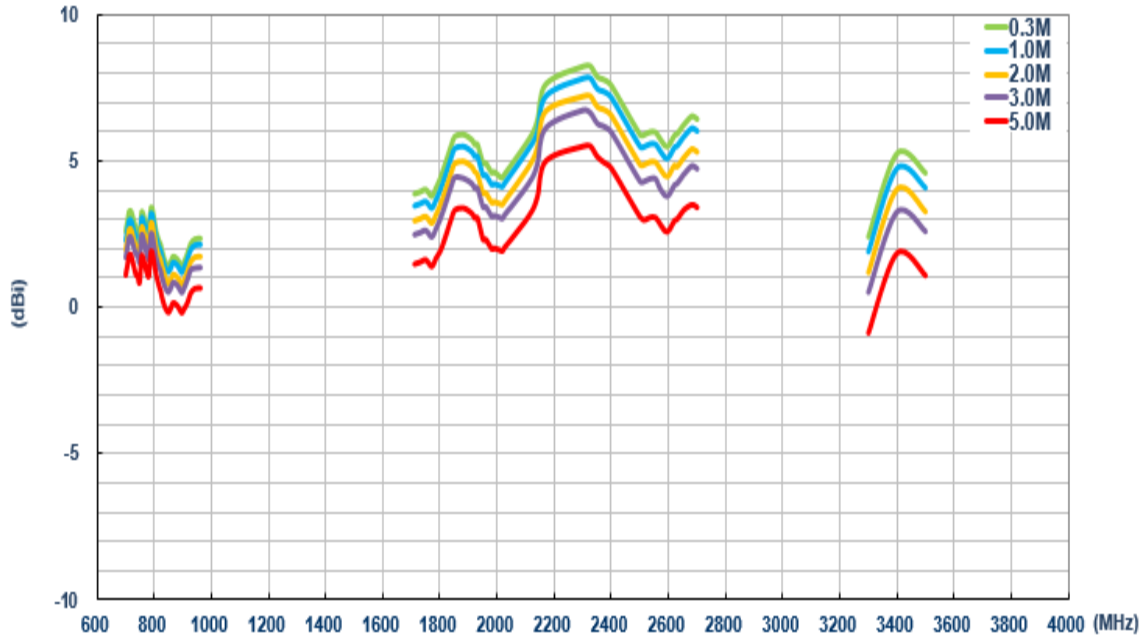

6.10. On the wall (Wi-Fi)

6.10.1. Return Loss (Wi-Fi_MIMO_1)

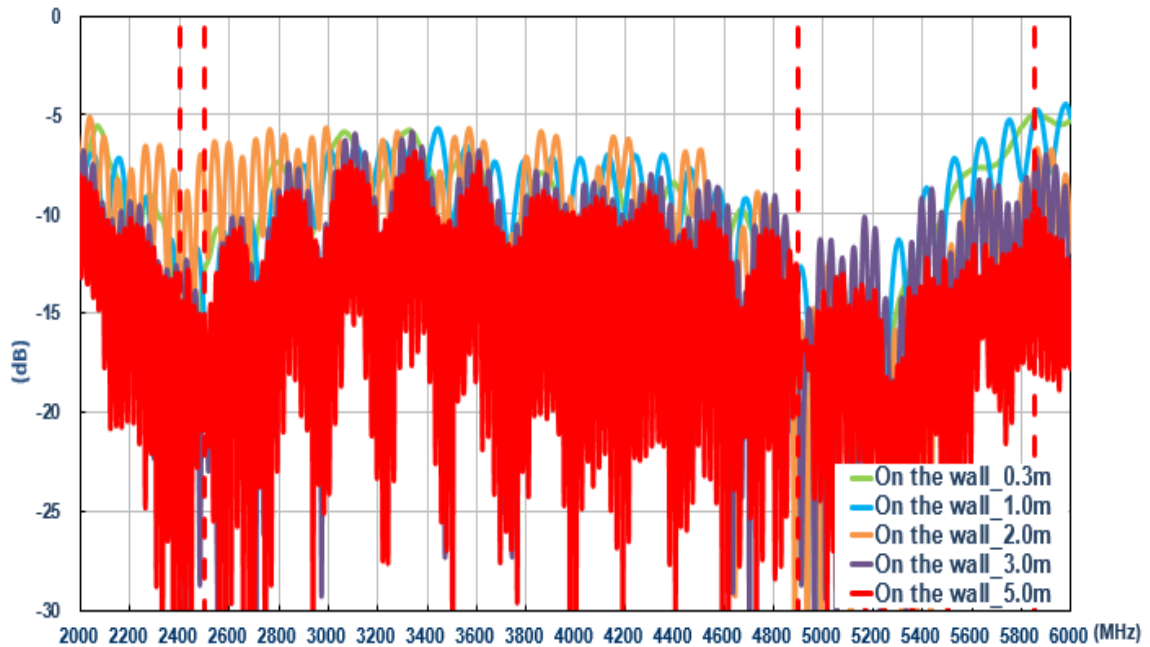

6.10.2. Return Loss (Wi-Fi_MIMO_2)

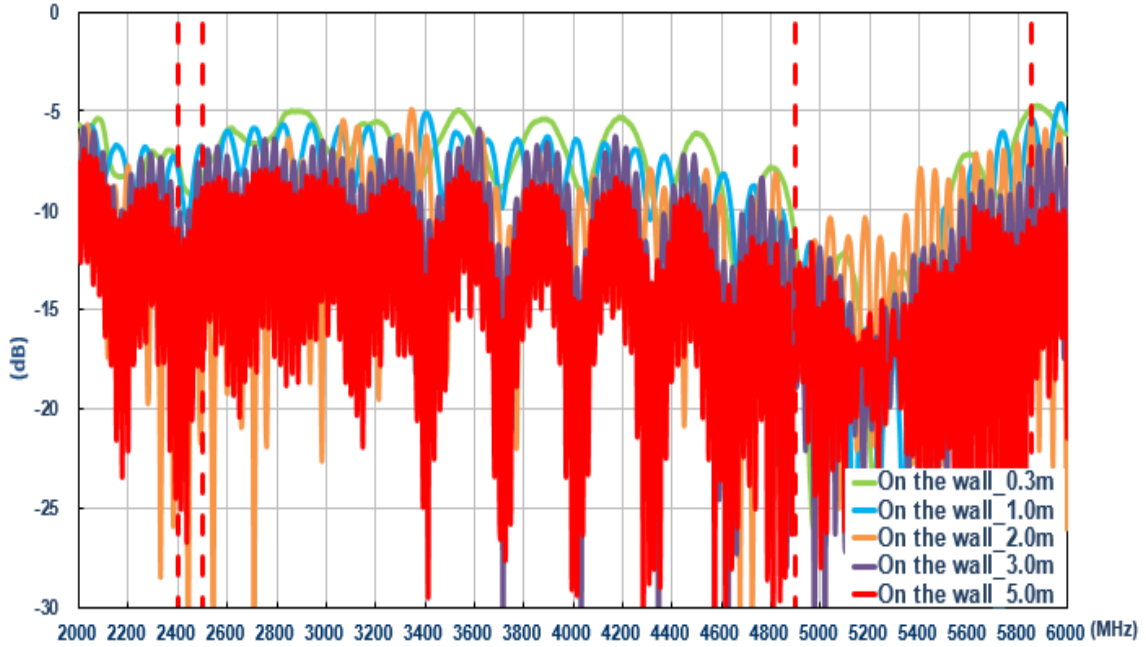

6.10.3. Isolation (Wi-Fi)

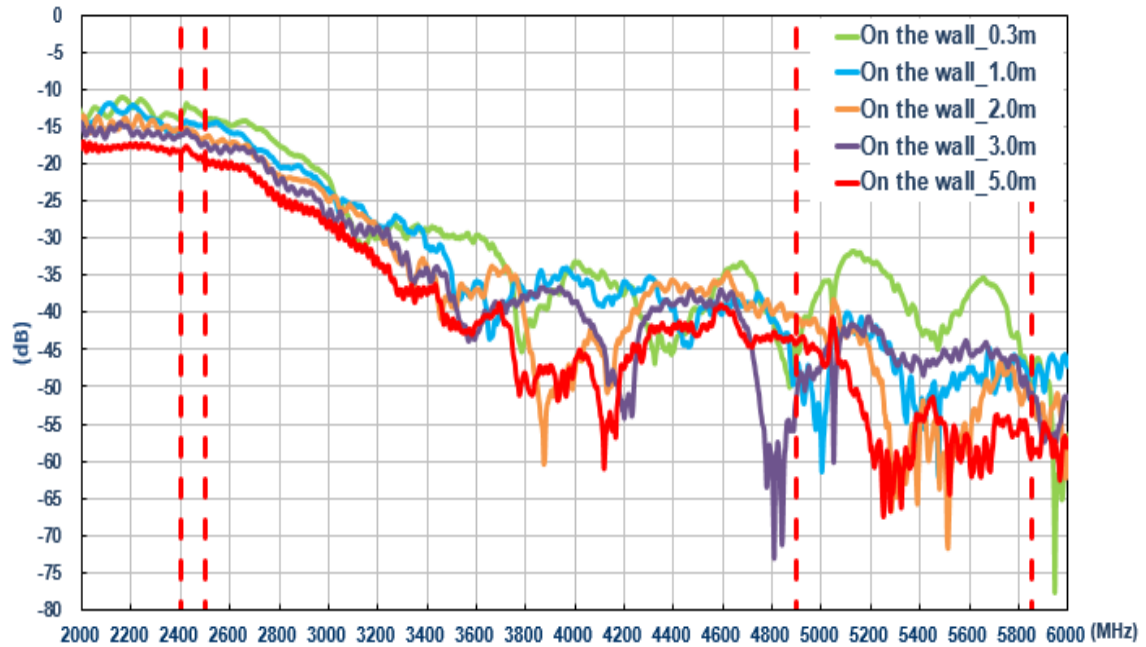

6.10.4. Efficiency (Wi-Fi_MIMO_1)

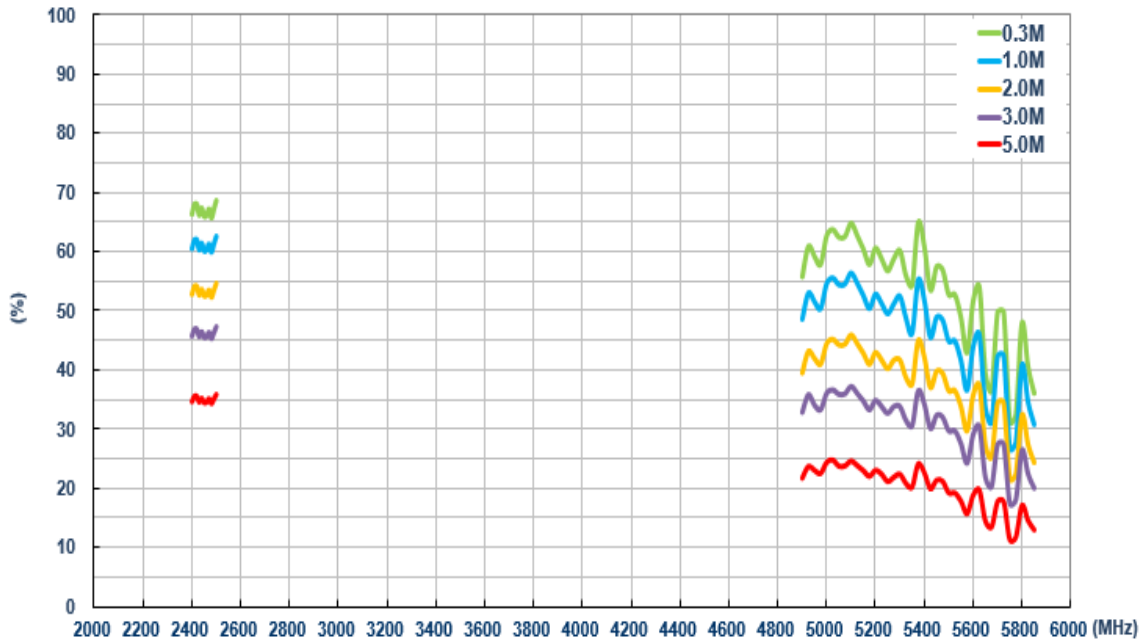

6.10.5. Efficiency (Wi-Fi_MIMO_2)

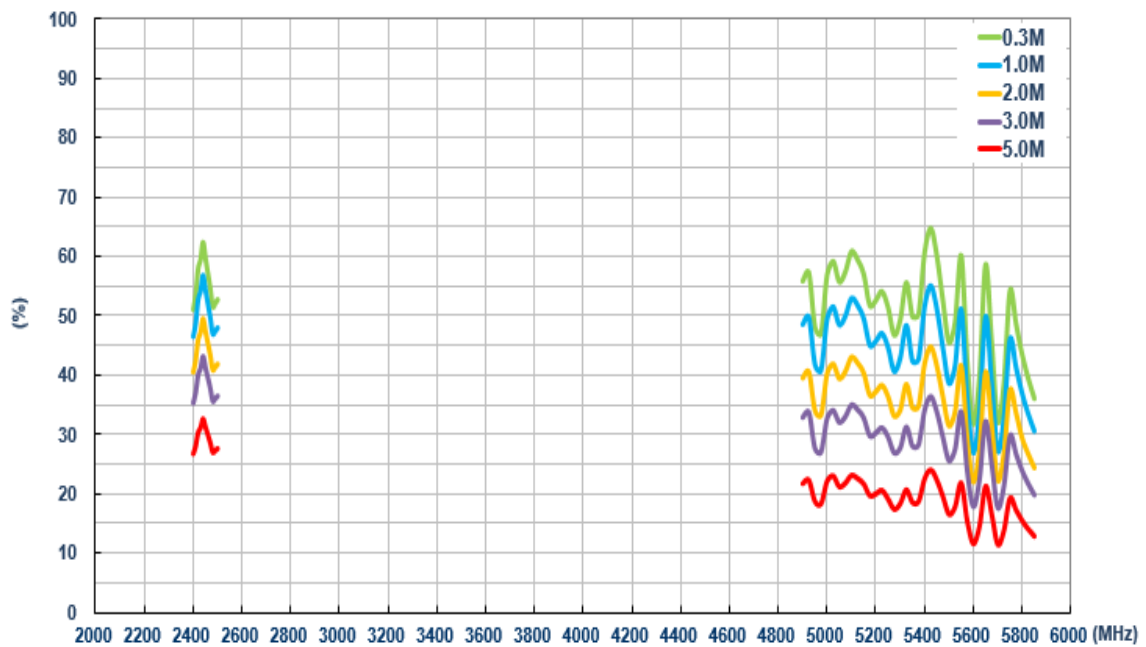

6.10.6. Average Gain (Wi-Fi_MIMO_1)

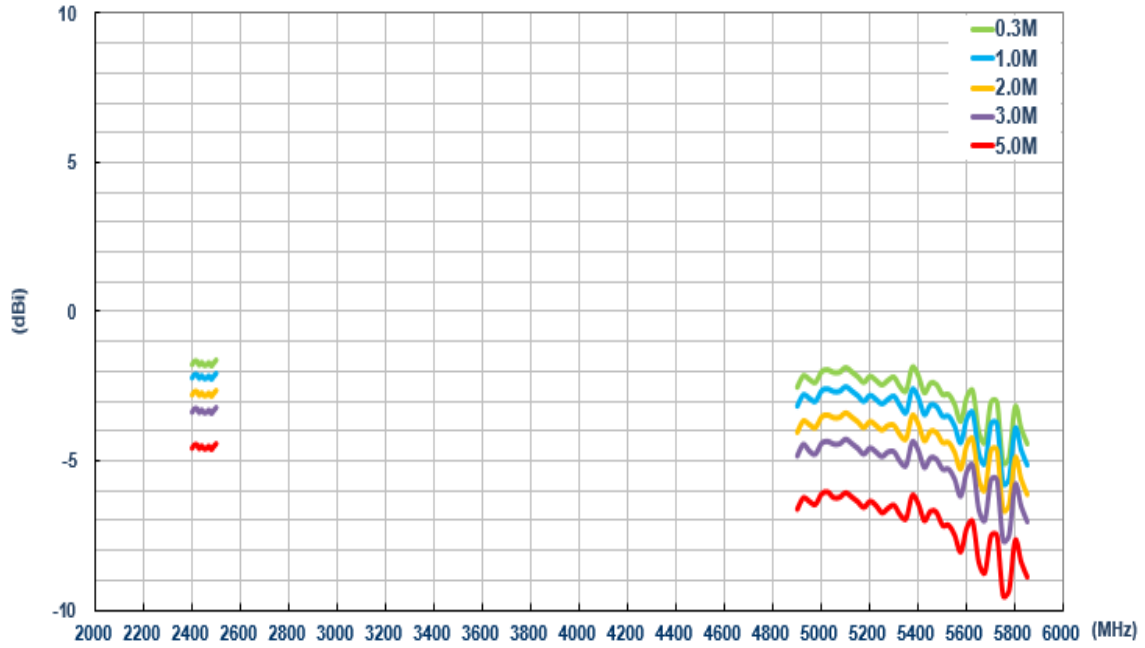

6.10.7. Average Gain (Wi-Fi_MIMO_2)

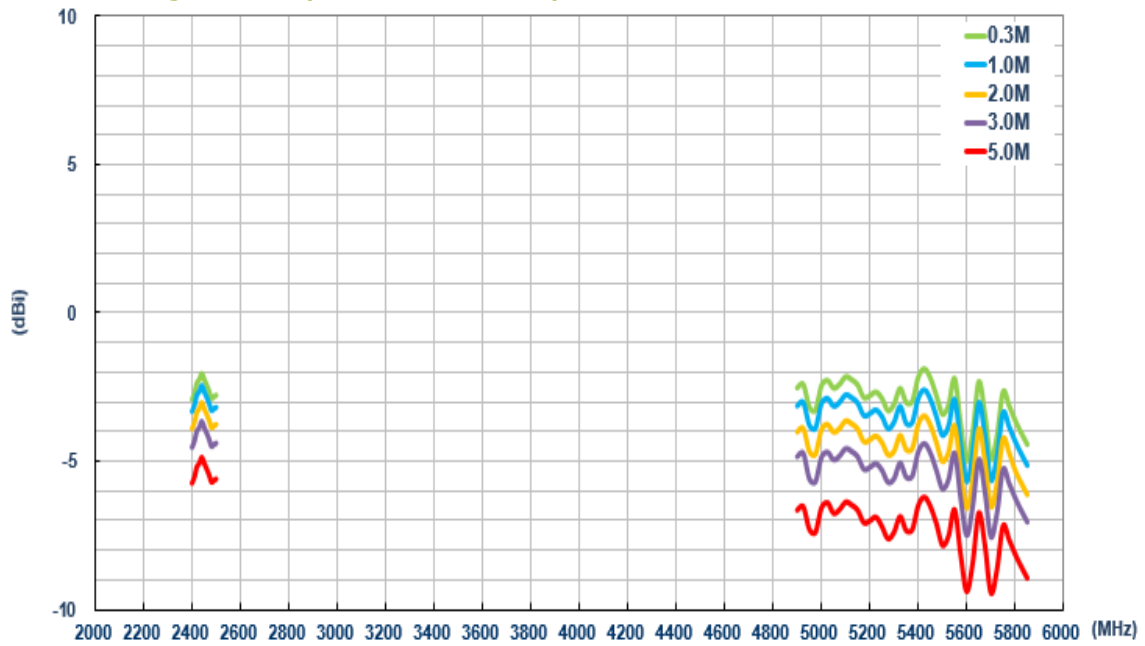

6.10.8. Peak Gain (Wi-Fi_MIMO_1)

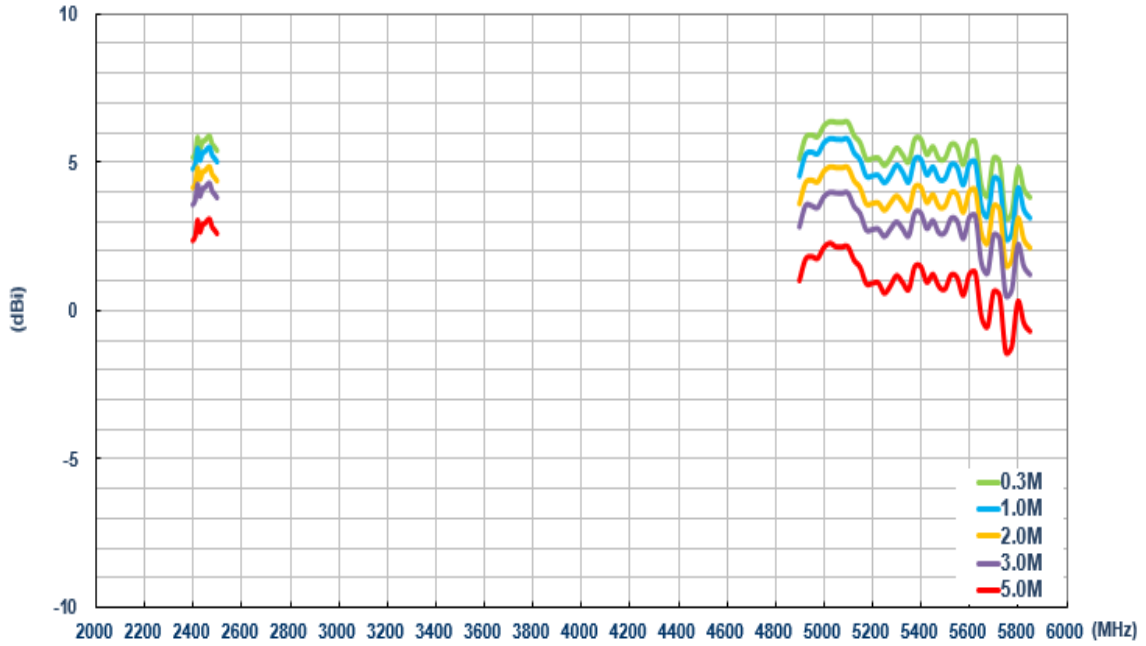

6.10.9. Peak Gain (Wi-Fi_MIMO_2)

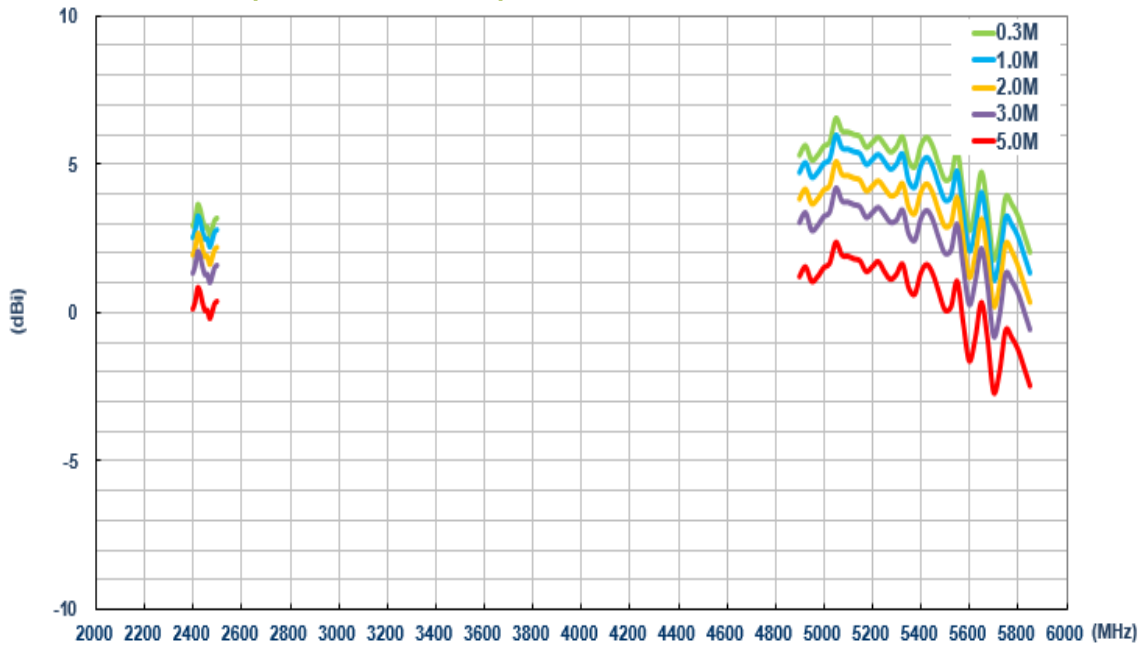

Taoglas makes no warranties based on the accuracy or completeness of the contents of this document and reserves the right to make changes to specifications and product descriptions at any time without notice. Taoglas reserves all rights to this document and the information contained herein.

Reproduction, use or disclosure to third parties without express permission is strictly prohibited.

Copyright © Taoglas Ltd.