

4200 Series

Tubeaxial

119x119x38mm



- DC fans with electronically commutated external rotor motor. Fully integrated commutation electronics.
- With electronic protection against reverse polarity, blocking and overloading by PTC-resistor; partially impedance protected.
- Mounting from either face using four 4.3 mm holes.
- Fan of fiberglass reinforced plastic. PBTP housing, PA impeller.
- Air exhaust over struts. Rotational direction CCW looking at rotor.
- Electrical connection via leads AWG 22, TR 64. Stripped and tinned ends.
- UL, CSA, VDE approvals on some models, please contact application engineering.

Part Number	Curve	CFM @ 0	VDC	Volt. Range	Power (W)	dBA	Max Amb. Temp C	Bearing Type	Features	Wgt. (lbs)
4212L	1	50.6	12	7 to 14.5	1.2	29	75	Ball	Leads	0.64
4212GM	2	74.7	12	7 to 14.5	2.2	38	75	Sintec	Leads	0.64
4212M	2	74.7	12	7 to 14.5	2.2	38	75	Ball	Leads	0.64
4212	3	97.1	12	7 to 14.5	4.3	45	75	Ball	Leads	0.64
4212/2	3	97.1	12	7 to 14.5	4.3	45	75	Ball	Leads	0.64
4212/12	3	97.1	12	7 to 14.5	4.3	45	75	Ball	Leads	0.64
4212H	4	108.3	12	7 to 14.5	5.3	49	65	Ball	Leads	0.64
4214L	1	50.6	24	12 to 28	1.2	29	75	Ball	Leads	0.64
4214	3	97.1	24	12 to 28	4.3	45	75	Ball	Leads	0.64
4214G	3	97.1	24	12 to 28	4.3	45	75	Sintec	Leads	0.64
4214H	4	108.3	24	12 to 28	5.3	49	65	Ball	Leads	0.64
4218	3	97.1	48	36 to 56	4.3	45	75	Ball	Leads	0.64
4218/2	3	97.1	48	36 to 56	4.3	45	75	Ball	Leads	0.64
4218H	4	108.3	48	36 to 56	5.6	49	65	Ball	Terminals	0.64

Terminal option available upon request.

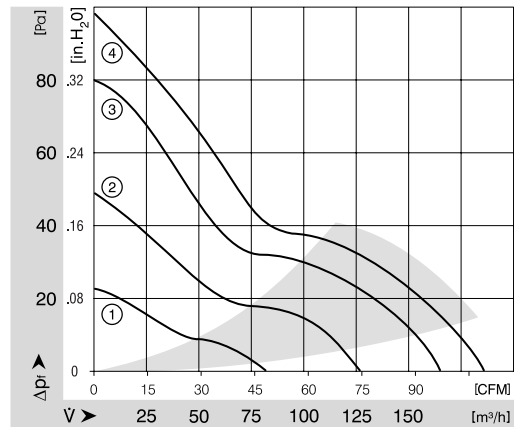
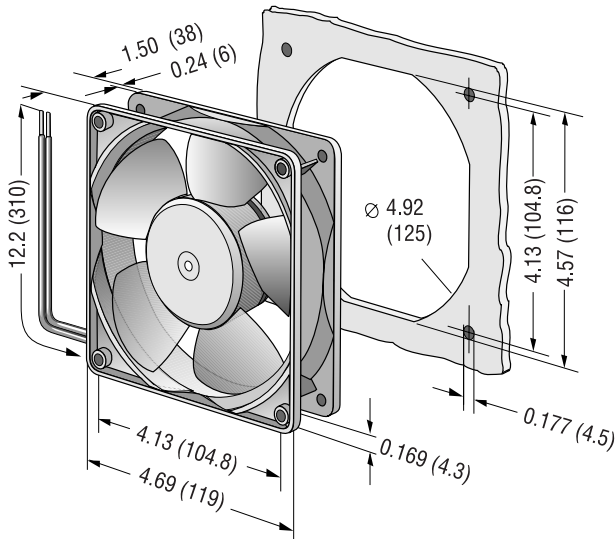

Speed signal /12

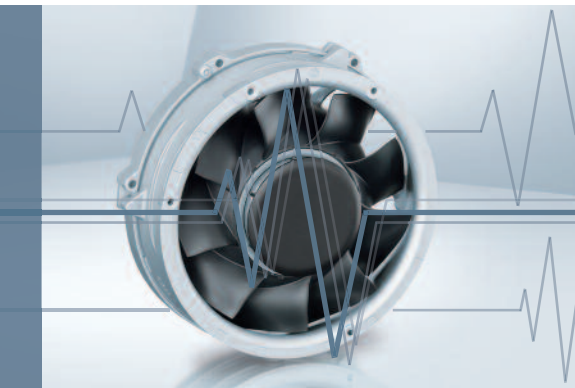

- Speed-proportional, square-wave signal for external monitoring of the fan motor speed
- 2, 3, or 6 pulses per revolution
- TTL-compatible
- Integrated pull-up resistor
- Connection via separate cable
- The sensor signal also serves as a major comparison variable for setting and maintaining the setpoint speed for interactive or controlled cooling with one or more interconnected fans.

Electrical hookup

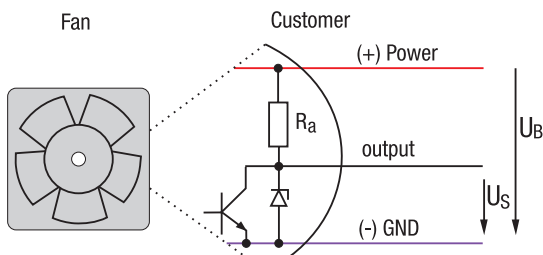

All voltages measured to ground.

Signal output voltage

Standard signal for all models (exceptions see below)

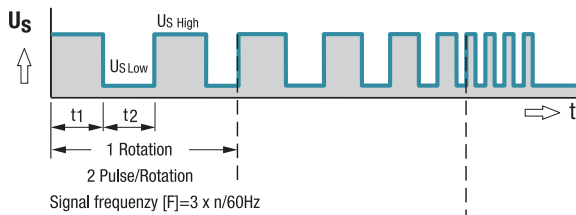

For multi options control input and 4100 NH7 and NH8

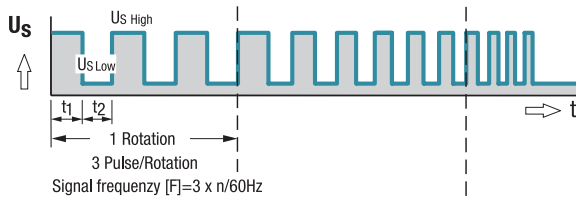

All TD Fans e.g. 6300 TD

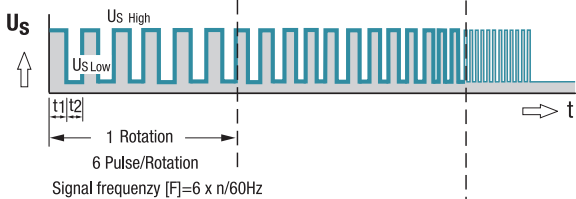

Fan speed

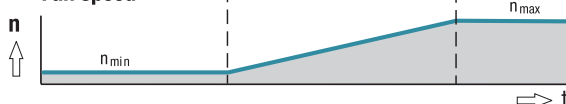

Signal data	Speed signal $U_{S\text{Low}}$	Condition: I_{sink}	Speed signal $U_{S\text{High}}$	Condition: I_{source}	Admissible sink current $I_{\text{sink max}}$	Fan description Basic type
Type	VDC	mA	VDC	mA	mA	Page
614 N/12 GM	≤ 0.4	1	2.5–5.5	1	1	39
618 N/12 N	≤ 0.4	1	2.5–5.5	1	1	39
8412 N/12 H	≤ 0.4	1	2.5–5.5	1	1	44
4412 F/12 GM	≤ 0.4	1	2.5–5.5	1	1	53
4418 F/12	≤ 0.4	1	2.5–5.5	1	1	53
4312 /12 M	≤ 0.4	1	2.5–5.5	1	1	56
4314 /12	≤ 0.4	1	2.5–5.5	1	1	56
4182 N/12 X	≤ 0.4	1	2.5–5.5	1	1	60

Subject to change

Note:

With these fan options, deviations in regard to temperature range, voltage range and power consumption are possible compared with standard fan data.

Available on request:

- Electrically isolated speed signal circuit
- Varying voltage potentials for power and logic circuit

Signal data		Speed signal U _S Low	Condition: I _{sink}	Speed signal U _S High	Condition: I _{source}	Admissible sink current I _{sink} max.	Fan description Basic type
Type	VDC	mA	VDC	mA	mA	Page	
7214 N/12	≤0.4	2	2.5–5.5	1	≤20	70	
6424/12 H	≤0.4	2	2.5–5.5	1	≤20	71	
DV 6424/12	≤0.4	2	4.5–5.25	2	≤12	73	
DV 6448/12	≤0.4	2	4.5–5.25	2	≤12	73	
RG 125-19/12 N/12	≤0.4	1	2.5–5.5	1	≤1	103	
RG 160-28/12 N/12	≤0.4	2	2.5–5.5	1	≤5	104	
RG 160-28/18 N/12	≤0.4	2	2.5–5.5	1	≤20	104	
RER 125-19/12 N/12	≤0.4	1	2.5–5.5	1	≤1	116	
RER 160-28/12 N/12	≤0.4	2	2.5–5.5	1	≤5	118	
RER 160-28/18 N/12	≤0.4	2	2.5–5.5	1	≤20	118	

Subject to change

Note:

Fans that come with these fan specials could have variations with respect to the temperature range, voltage range, and power consumption compared to standard fans without specials.