

**isc N-Channel MOSFET Transistor**

**IPW60R099C7**

**IIPW60R099C7**

**• FEATURES**

- Static drain-source on-resistance:  
 $R_{ds(on)} \leq 99m\Omega$
- Enhancement mode:
- 100% avalanche tested
- Minimum Lot-to-Lot variations for robust device performance and reliable operation

**• DESCRIPTION**

- Suitable for hard and soft switching

**• ABSOLUTE MAXIMUM RATINGS(T<sub>a</sub>=25°C)**

SYMBOL	PARAMETER	VALUE	UNIT
V <sub>DSS</sub>	Drain-Source Voltage	600	V
V <sub>GS</sub>	Gate-Source Voltage	±20	V
I <sub>D</sub>	Drain Current-Continuous	22	A
I <sub>DM</sub>	Drain Current-Single Pulsed	83	A
P <sub>D</sub>	Total Dissipation @T <sub>c</sub> =25°C	110	W
T <sub>j</sub>	Max. Operating Junction Temperature	150	°C
T <sub>stg</sub>	Storage Temperature	-55~150	°C

**• THERMAL CHARACTERISTICS**

SYMBOL	PARAMETER	MAX	UNIT
R <sub>th(j-c)</sub>	Channel-to-case thermal resistance	1.135	°C/W
R <sub>th(j-a)</sub>	Channel-to-ambient thermal resistance	62	°C/W

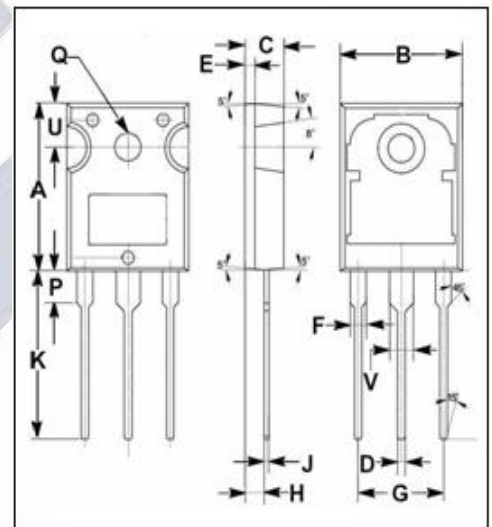
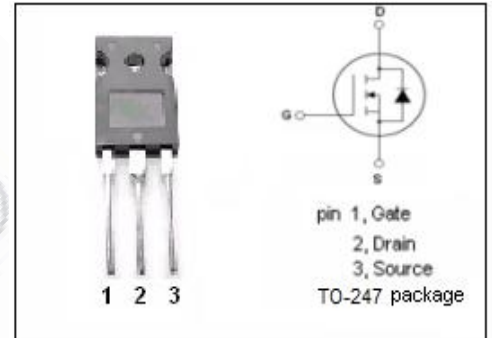

DIM	mm	
	MIN	MAX
A	19.80	20.20
B	15.40	15.80
C	4.90	5.10
D	0.90	1.10
E	1.40	1.60
F	1.90	2.10
G	10.80	11.00
H	2.40	2.60
J	0.50	0.70
K	19.50	20.50
P	3.90	4.10
Q	3.30	3.50
U	5.20	5.40
V	2.90	3.10

**isc N-Channel MOSFET Transistor**
**IPW60R099C7**
**IIPW60R099C7**
**ELECTRICAL CHARACTERISTICS**

 T<sub>c</sub>=25°C unless otherwise specified

SYMBOL	PARAMETER	CONDITIONS	MIN	TYP	MAX	UNIT
B <sub>V</sub> DSS	Drain-Source Breakdown Voltage	V <sub>GS</sub> =0V; I <sub>D</sub> =1mA	600			V
V <sub>GS(th)</sub>	Gate Threshold Voltage	V <sub>DS</sub> =V <sub>GS</sub> ; I <sub>D</sub> =0.49mA	3		4	V
R <sub>DS(on)</sub>	Drain-Source On-Resistance	V <sub>GS</sub> =10V; I <sub>D</sub> =9.7A			99	mΩ
I <sub>GSS</sub>	Gate-Source Leakage Current	V <sub>GS</sub> = 20V; V <sub>DS</sub> =0V			0.1	μA
I <sub>DSS</sub>	Drain-Source Leakage Current	V <sub>DS</sub> =600V; V <sub>GS</sub> = 0V			1	μA
V <sub>SD</sub>	Diode forward voltage	I <sub>F</sub> =9.7A, V <sub>GS</sub> = 0V				V