

### PDFN56

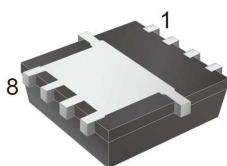

### Pin Definition:

- |           |          |
|-----------|----------|
| 1. Source | 8. Drain |
| 2. Source | 7. Drain |
| 3. Source | 6. Drain |
| 4. Gate   | 5. Drain |

### Key Parameter Performance

Parameter	Value	Unit
$V_{DS}$	40	V
$R_{DS(on)}(max)$	2.8	m $\Omega$
$Q_g$	78	nC

### Features

- Low On-Resistance
- Low Input Capacitance
- Low Gate Charge

### Ordering Information

Part No.	Package	Packing
TSM028N04PQ56 RLG	PDFN56	2.5kpcs / 13" Reel

**Note:** "G" denotes for Halogen- and Antimony-free as those which contain <900ppm bromine, <900ppm chlorine (<1500ppm total Br + Cl) and <1000ppm antimony compounds.

### Block Diagram

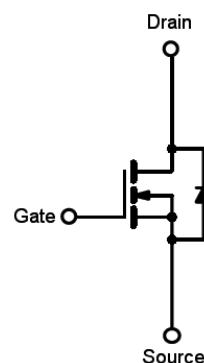

N-Channel MOSFET

### Absolute Maximum Ratings ( $T_C=25^{\circ}C$ unless otherwise noted)

Parameter	Symbol	Limit	Unit
Drain-Source Voltage	$V_{DS}$	40	V
Gate-Source Voltage	$V_{GS}$	$\pm 20$	V
Continuous Drain Current <sup>(Note 3)</sup>	$I_D$	$T_C=25^{\circ}C$	140
		$T_A=25^{\circ}C$	42
Drain Current-Pulsed <sup>(Note 1)</sup>	$I_{DM}$	550	A
Single Pulse Avalanche Energy: L=0.1mH	$E_{AS}$	201	mJ
Maximum Power Dissipation <sup>(Note 2)</sup>	$P_D$	$T_C=25^{\circ}C$	83
		$T_A=25^{\circ}C$	4.4
Storage Temperature Range	$T_{STG}$	-55 to +150	$^{\circ}C$
Operating Junction Temperature Range	$T_J$	-55 to +150	$^{\circ}C$

### Thermal Performance

Parameter	Symbol	Limit	Unit
Thermal Resistance - Junction to Case	$R_{\theta JC}$	1.5	$^{\circ}C/W$
Thermal Resistance - Junction to Ambient	$R_{\theta JA}$	28	$^{\circ}C/W$

### Electrical Specifications (T<sub>J</sub>=25°C unless otherwise noted)

Parameter	Conditions	Symbol	Min	Typ	Max	Unit
<b>Static</b>						
Drain-Source Breakdown Voltage	V <sub>GS</sub> = 0V, I <sub>D</sub> = 250μA	BV <sub>DSS</sub>	40	--	--	V
Drain-Source On-State Resistance	V <sub>GS</sub> = 10V, I <sub>D</sub> = 30A	R <sub>DS(ON)</sub>	--	2.1	2.8	mΩ
Gate Threshold Voltage	V <sub>DS</sub> = V <sub>GS</sub> , I <sub>D</sub> = 250μA	V <sub>GS(TH)</sub>	2	3	4	V
Zero Gate Voltage Drain Current	V <sub>DS</sub> = 32V, V <sub>GS</sub> = 0V	I <sub>DSS</sub>	--	--	1	μA
Gate Body Leakage	V <sub>GS</sub> = ±20V, V <sub>DS</sub> = 0V	I <sub>GSS</sub>	--	--	±100	nA
<b>Dynamic</b>						
Total Gate Charge	V <sub>DD</sub> = 20V, I <sub>D</sub> = 30A, V <sub>GS</sub> = 10V	Q <sub>g</sub>	--	78	--	nC
Gate-Source Charge		Q <sub>gs</sub>	--	22	--	
Gate-Drain Charge		Q <sub>gd</sub>	--	4.7	--	
Input Capacitance	V <sub>DS</sub> = 20V, V <sub>GS</sub> = 0V, f = 1.0MHz	C <sub>iss</sub>	--	4222	--	pF
Output Capacitance		C <sub>oss</sub>	--	889	--	
Reverse Transfer Capacitance		C <sub>rss</sub>	--	398	--	
<b>Switching</b>						
Turn-On Delay Time	V <sub>GS</sub> = 10V, V <sub>DD</sub> = 20V, R <sub>G</sub> = 3Ω, I <sub>D</sub> = 13A	t <sub>d(on)</sub>	--	21	--	ns
Turn-On Rise Time		t <sub>r</sub>	--	6	--	
Turn-Off Delay Time		t <sub>d(off)</sub>	--	98	--	
Turn-Off Fall Time		t <sub>f</sub>	--	17	--	
<b>Drain-Source Diode Characteristics and Maximum Rating</b>						
Drain-Source Diode Forward Voltage	V <sub>GS</sub> =0V, I <sub>S</sub> =30A	V <sub>SD</sub>	--	--	1.3	V
Reverse Recovery Time	I <sub>S</sub> = 30A, dI/dt = 100A/μs	t <sub>rr</sub>	--	32	--	ns
Reverse Recovery Charge		Q <sub>rr</sub>	--	120	--	nC

#### Notes:

1. Pulse Test: Pulse Width ≤ 300μs, Duty Cycle ≤ 2%.
2. R<sub>θJA</sub> is the sum of the junction-to-case and case-to-ambient thermal resistances. The case thermal reference is defined at the solder mounting surface of the drain pins. R<sub>θJA</sub> is guaranteed by design while R<sub>θCA</sub> is determined by the user's board design. R<sub>θJA</sub> shown below for single device operation on FR-4 PCB in still air.
3. The maximum current rating is limited by package.

## Electrical Characteristics Curves

**Output Characteristics**

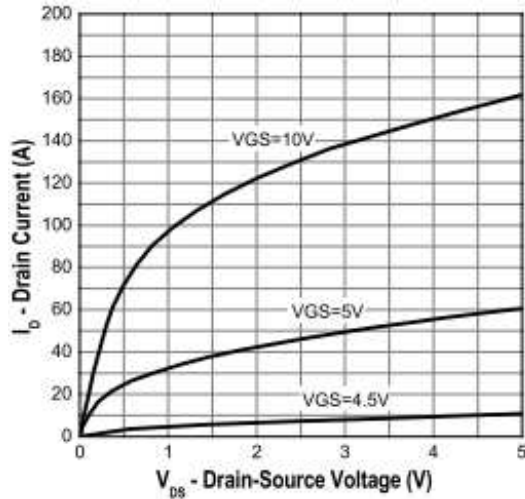

**Gate Threshold Voltage**

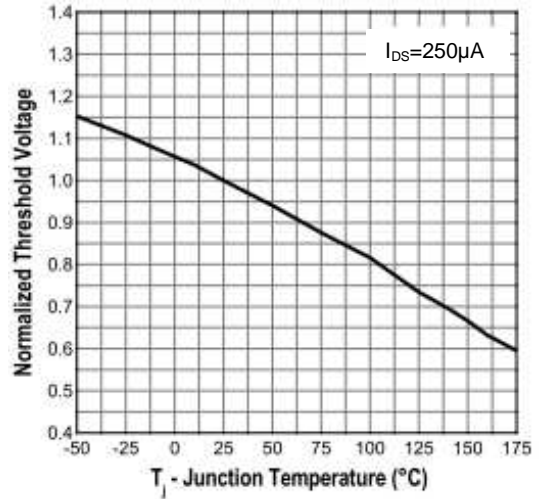

**Gate Source On Resistance**

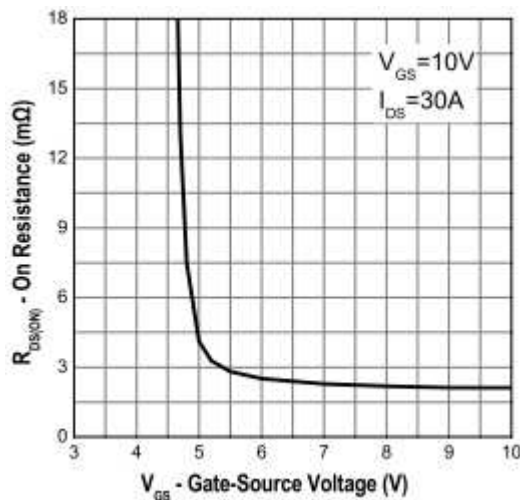

**Drain-Source On Resistance**

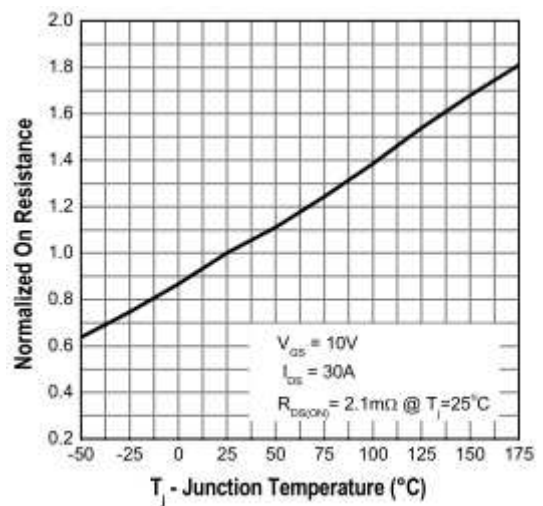

**Drain-Source On-Resistance**

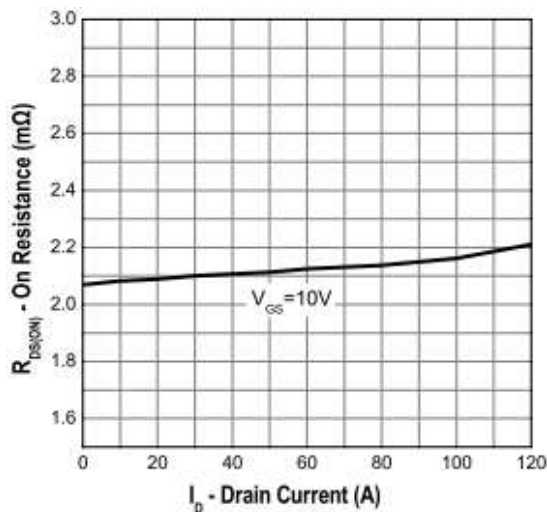

**Source-Drain Diode Forward Voltage**

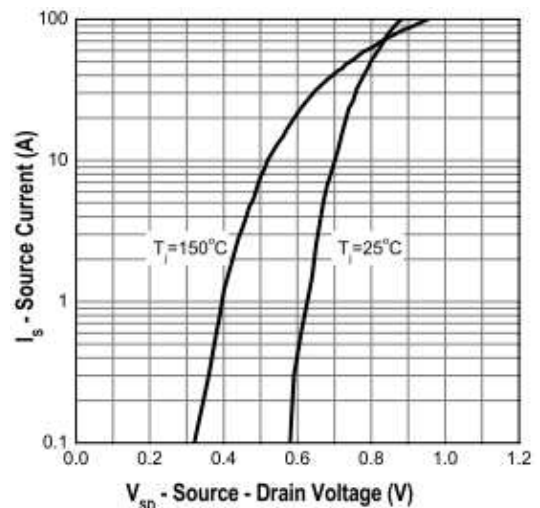

### Electrical Characteristics Curves

**Power Derating**

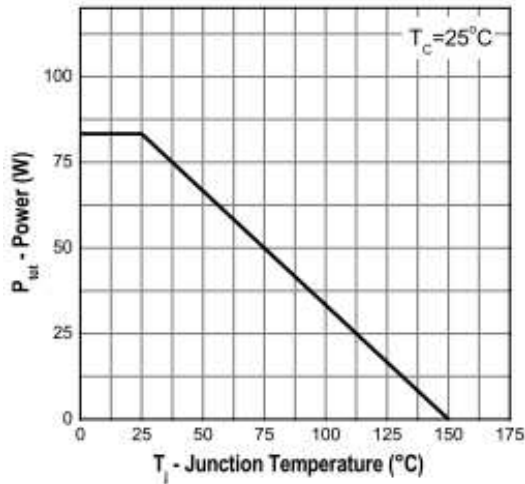

**Drain Current vs. Junction Temperature**

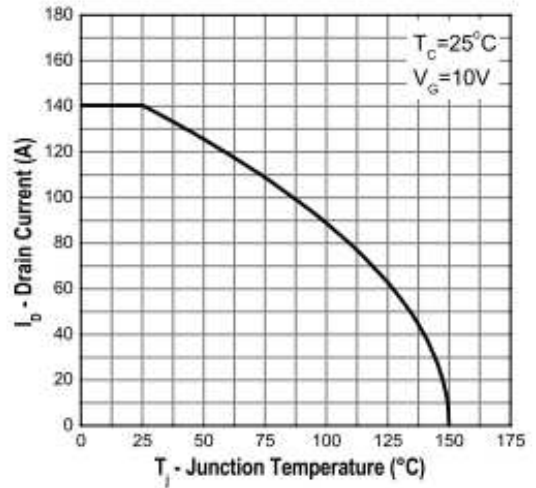

**Safe Operation Area**

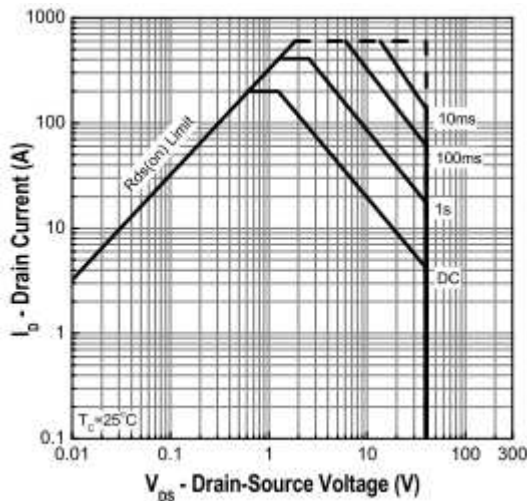

**Transient Thermal Impedance**

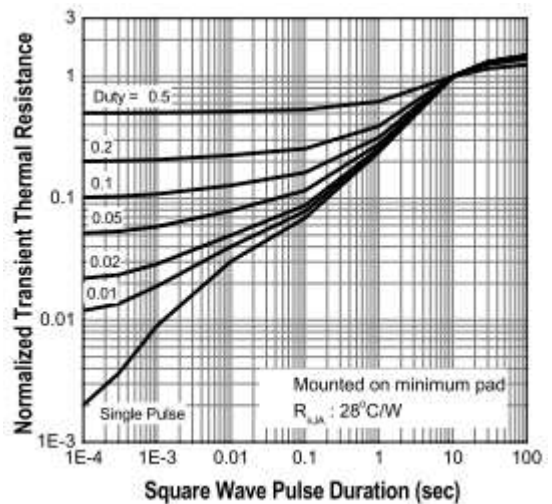

**Capacitance**

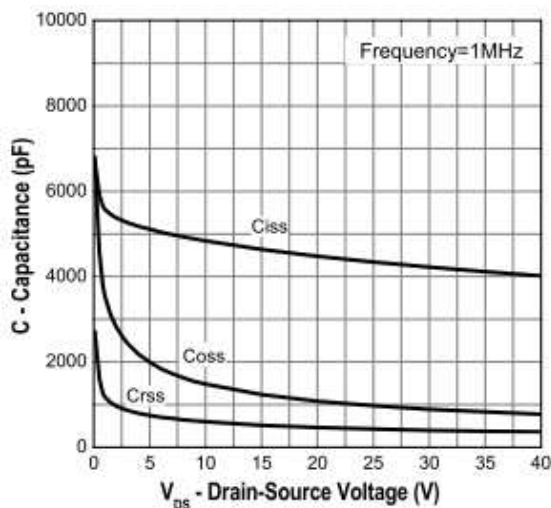

**Gate Charge**

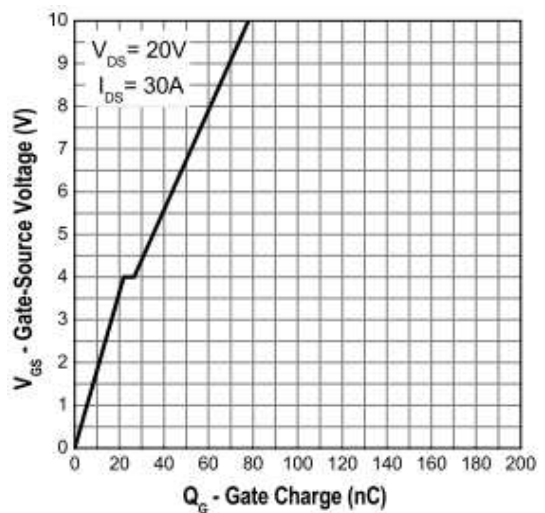

**PDFN56 Mechanical Drawing**

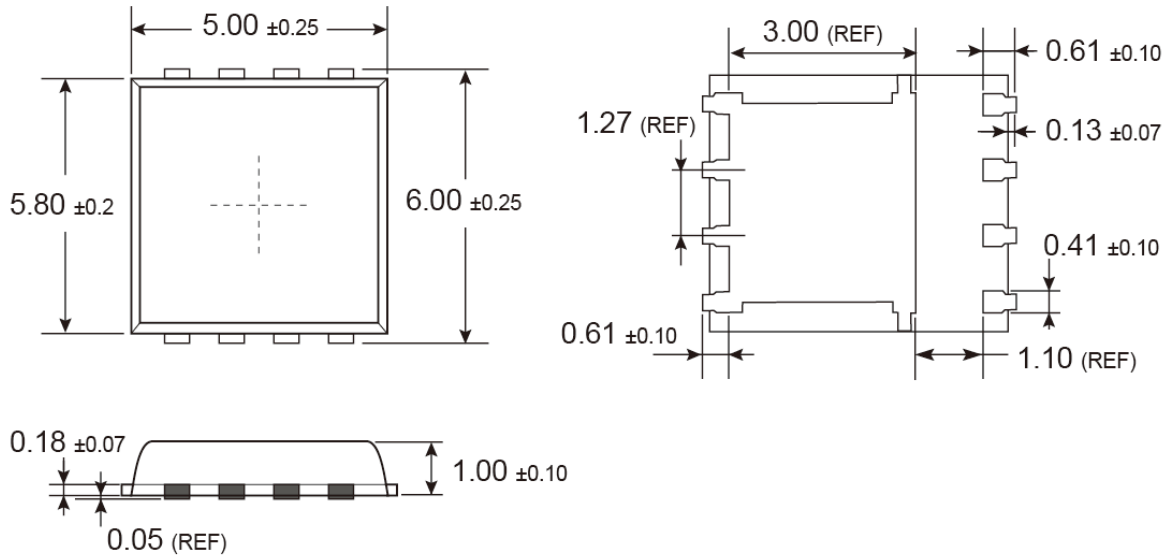

Unit: Millimeters

**Marking Diagram**



- Y** = Year Code
- M** = Month Code for Halogen Free Product  
(**O**=Jan, **P**=Feb, **Q**=Mar, **R**=Apr, **S**=May, **T**=Jun, **U**=Jul, **V**=Aug, **W**=Sep, **X**=Oct, **Y**=Nov, **Z**=Dec)
- L** = Lot Code

## Notice

Specifications of the products displayed herein are subject to change without notice. TSC or anyone on its behalf, assumes no responsibility or liability for any errors or inaccuracies.

Information contained herein is intended to provide a product description only. No license, express or implied, to any intellectual property rights is granted by this document. Except as provided in TSC's terms and conditions of sale for such products, TSC assumes no liability whatsoever, and disclaims any express or implied warranty, relating to sale and/or use of TSC products including liability or warranties relating to fitness for a particular purpose, merchantability, or infringement of any patent, copyright, or other intellectual property right.

The products shown herein are not designed for use in medical, life-saving, or life-sustaining applications. Customers using or selling these products for use in such applications do so at their own risk and agree to fully indemnify TSC for any damages resulting from such improper use or sale.