



ON Semiconductor®

<http://onsemi.com>

NDBA170N06A

N-Channel Power MOSFET 60V, 170A, 3.3mΩ, TO-263

Features

- On-resistance $R_{DS(on)}=2.5m\Omega$ (typ.)
- Input Capacitance $C_{iss}=15800pF$ (typ.)
- Halogen free compliance

Specifications

Absolute Maximum Ratings at $T_a = 25^\circ C$

Parameter	Symbol	Value	Unit
Drain to Source Voltage	V_{DSS}	60	V
Gate to Source Voltage	V_{GSS}	± 20	V
Drain Current (DC)	I_D	170	A
Drain Current (DC) Limited by Package	I_{DL}	100	A
Drain Current (Pulse) $PW \leq 10\mu s$, duty cycle $\leq 1\%$	I_{DP}	600	A
Power Dissipation $T_c=25^\circ C$	P_D	90	W
Junction Temperature	T_J	150	$^\circ C$
Storage Temperature	T_{stg}	-55 to +150	$^\circ C$
Avalanche Energy (Single Pulse) * ¹	E_{AS}	571	mJ
Avalanche Current * ²	I_{AV}	70	A
Lead Temperature for Soldering Purposes, 3mm from Case for 10 Seconds	T_L	260	$^\circ C$

Thermal Resistance Ratings

Parameter	Symbol	Value	Unit
Junction- to-Case(Drain) Steady State	$R_{\theta JC}$	1.39	$^\circ C/W$
Junction-to-Ambient * ³	$R_{\theta JA}$	62.5	

Stresses exceeding Maximum Ratings may damage the device. Maximum Ratings are stress ratings only. Functional operation above the Recommended Operating Conditions is not implied. Extended exposure to stresses above the Recommended Operating Conditions may affect device reliability.

Note : *¹ $V_{DD}=36V$, $L=100\mu H$, $I_{AV}=70A$ (Fig.1)

*² $L \leq 100\mu H$, Single Pulse

*³ Surface mounted on FR4 board using recommended footprint

Electrical Connection

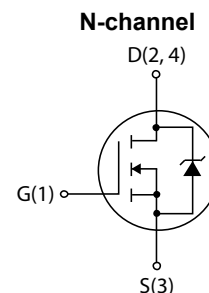

Marking

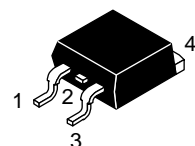

TO-263
CASE 418AJ

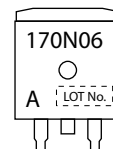

Packing Type:TL

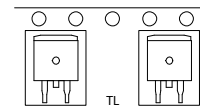

Ordering & Package Information

Device	Package	Shipping
NDBA170N06AT4H Pb-free and Halogen Free	TO-263	800 pcs. / reel

NDBA170N06A

Electrical Characteristics at Ta = 25°C

Parameter	Symbol	Conditions	Value			Unit	
			min	typ	max		
Drain to Source Breakdown Voltage	$V_{(BR)DSS}$	$I_D=1mA, V_{GS}=0V$	60			V	
Zero-Gate Voltage Drain Current	I_{DSS}	$V_{DS}=60V, V_{GS}=0V$			10	μA	
Gate to Source Leakage Current	I_{GSS}	$V_{GS}=\pm 20V, V_{DS}=0V$			± 200	nA	
Gate Threshold Voltage	$V_{GS(th)}$	$V_{DS}=10V, I_D=1mA$	1.2		2.6	V	
Forward Transconductance	g_{FS}	$V_{DS}=10V, I_D=50A$		150		S	
Static Drain to Source On-State Resistance	$R_{DS(on)}$	$I_D=50A, V_{GS}=10V$		2.5	3.3	$m\Omega$	
Input Capacitance	C_{iss}	$V_{DS}=20V, f=1MHz$		15800		pF	
Output Capacitance	C_{oss}				1000		pF
Reverse Transfer Capacitance	C_{rss}				740		pF
Turn-ON Delay Time	$t_{d(on)}$	See Fig.2		115		ns	
Rise Time	t_r			550		ns	
Turn-OFF Delay Time	$t_{d(off)}$			750		ns	
Fall Time	T_f			380		ns	
Total Gate Charge	Q_g	$V_{DS}=36V, V_{GS}=10V, I_D=100A$		280		nC	
Gate to Source Charge	Q_{gs}			56		nC	
Gate to Drain "Miller" Charge	Q_{gd}			60		nC	
Forward Diode Voltage	V_{SD}	$I_S=100A, V_{GS}=0V$		0.9	1.2	V	
Reverse Recovery Time	t_{rr}	See Fig.3		100		ns	
Reverse Recovery Charge	Q_{rr}	$I_S=100A, V_{GS}=0V, di/dt=100A/\mu s$		310		nC	

Fig.1 Unclamped Inductive Switching Test Circuit

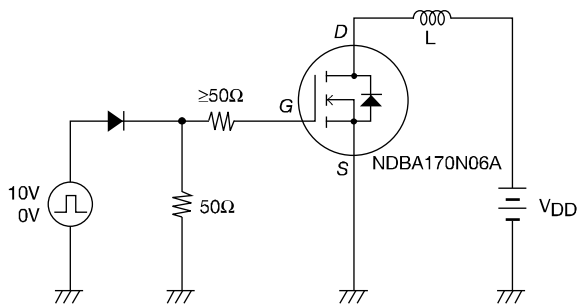

Fig.2 Switching Time Test Circuit

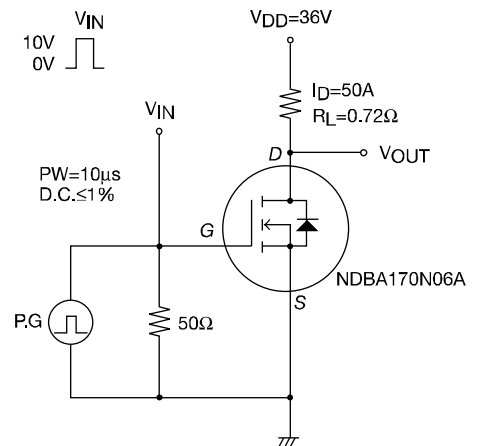
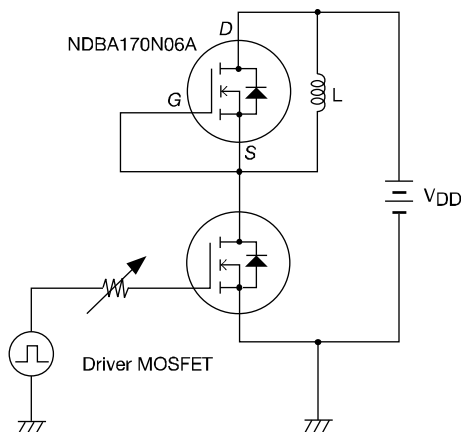
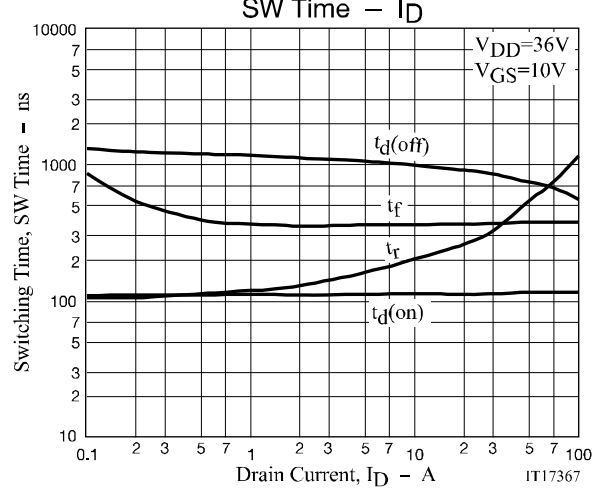
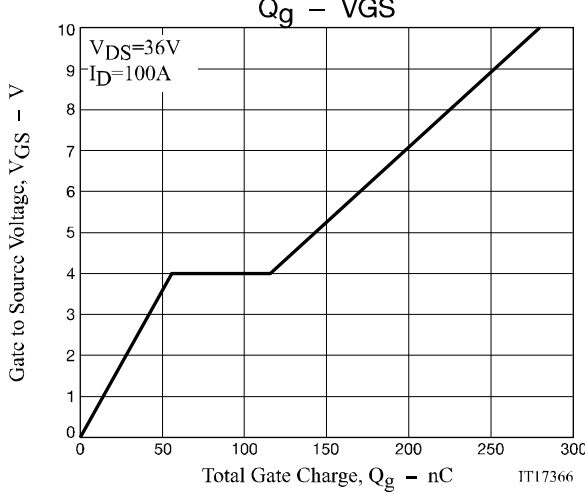
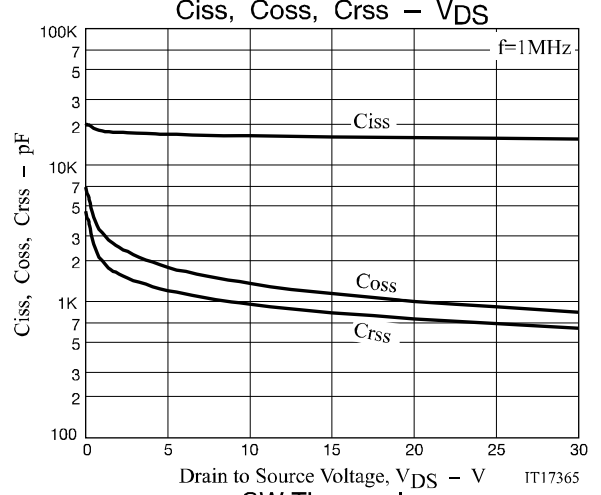
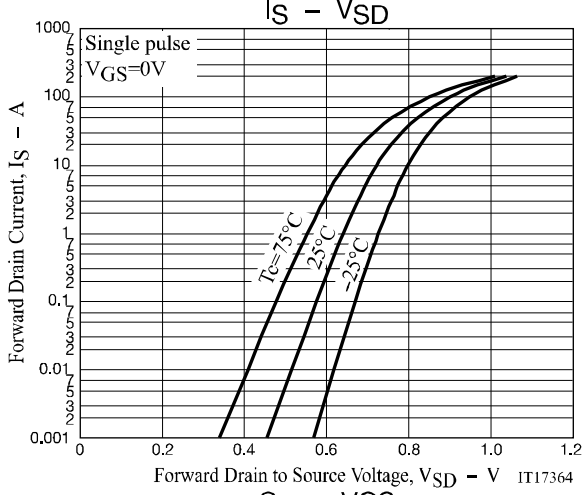
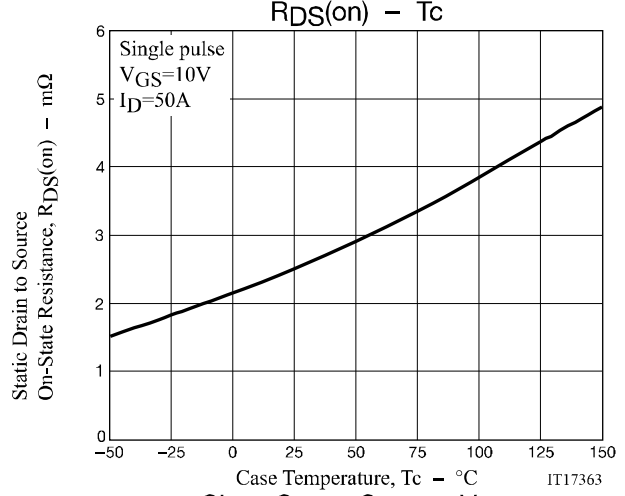
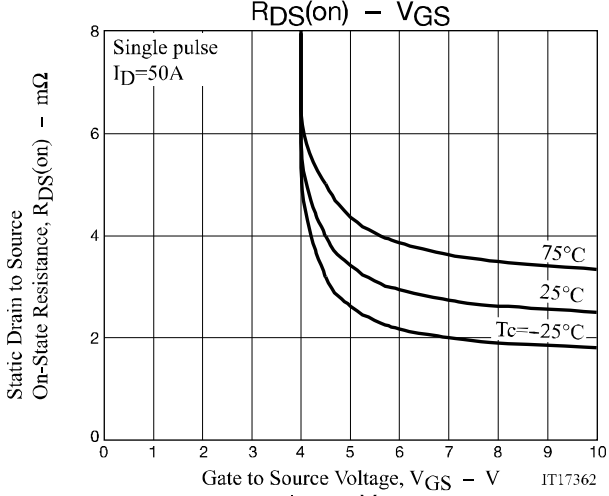
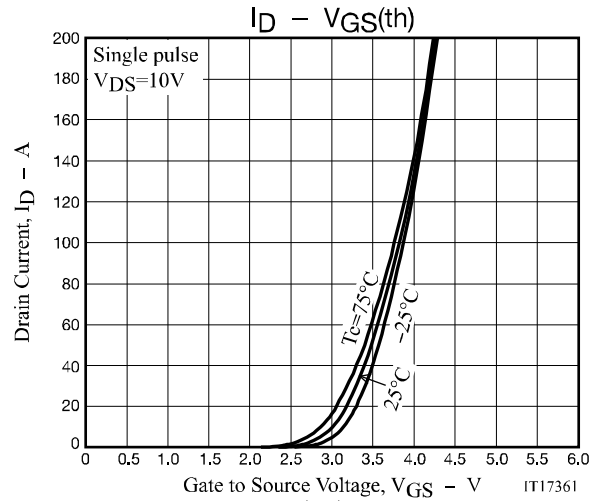
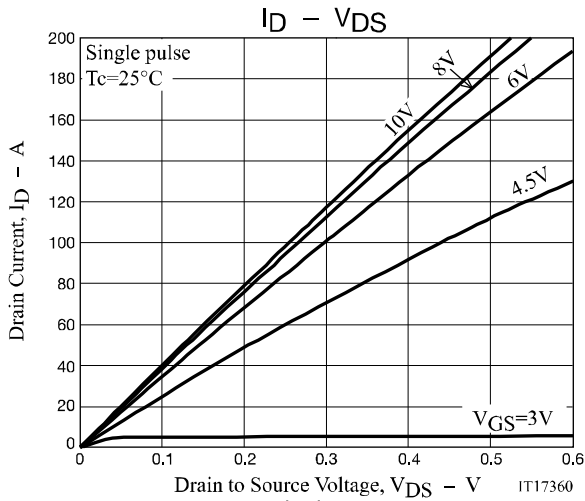

Fig.3 Reverse Recovery Time Test Circuit



NDBA170N06A



NDBA170N06A

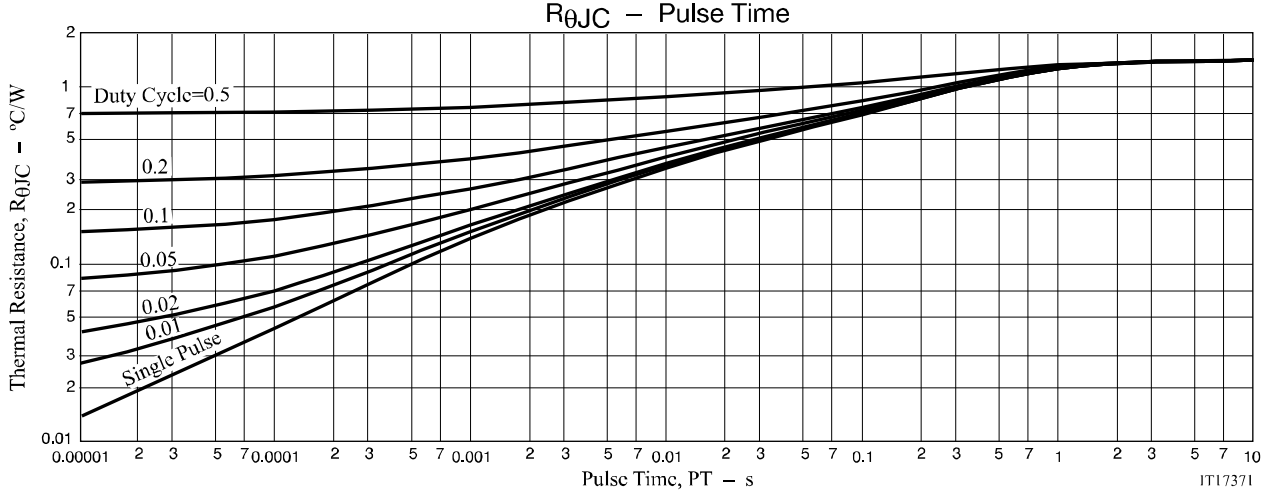
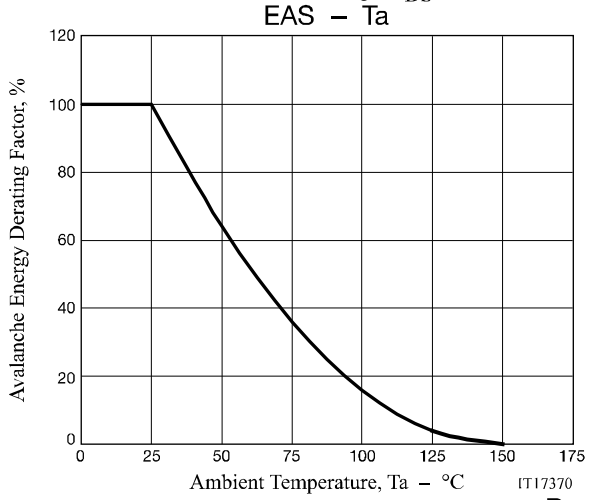
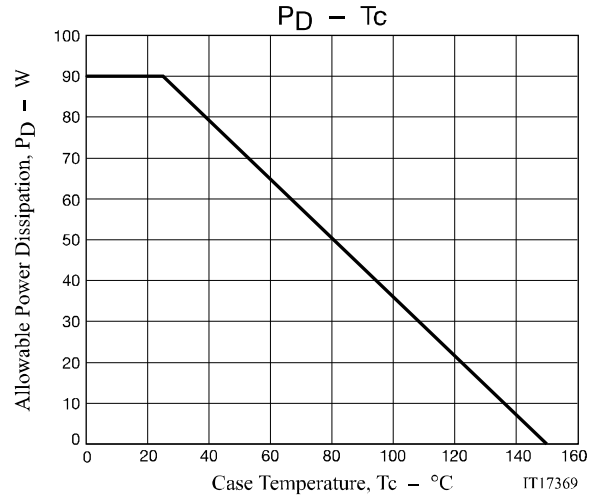
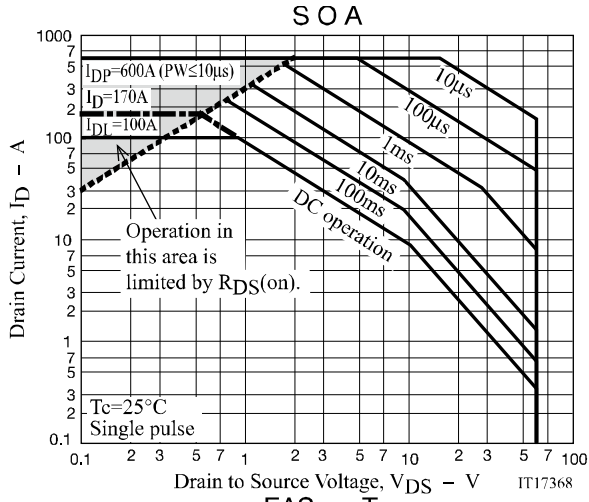

NDBA170N06A

PACKAGE DIMENSIONS

D²PAK-3 (TO-263, 3-LEAD)
CASE 418AJ
ISSUE B

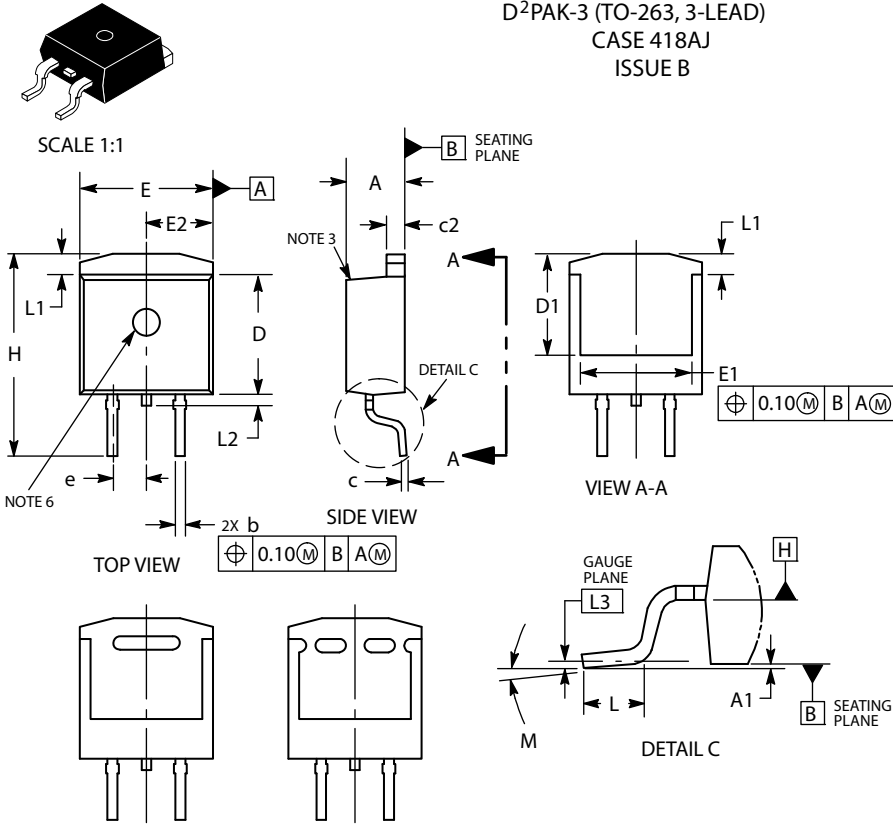

- NOTES:
1. DIMENSIONING AND TOLERANCING PER ASME Y14.5M, 1994.
 2. CONTROLLING DIMENSION: INCHES.
 3. CHAMFER OPTIONAL.
 4. DIMENSIONS D AND E DO NOT INCLUDE MOLD FLASH. MOLD FLASH SHALL NOT EXCEED 0.005 PER SIDE. THESE DIMENSIONS ARE MEASURED AT THE OUTERMOST EXTREMES OF THE PLASTIC BODY AT DATUM H.
 5. THERMAL PAD CONTOUR IS OPTIONAL WITHIN DIMENSIONS E, L1, D1 AND E1.
 6. OPTIONAL MOLD FEATURE

DIM	INCHES		MILLIMETERS	
	MIN	MAX	MIN	MAX
A	0.160	0.190	4.06	4.83
A1	0.000	0.010	0.00	0.25
b	0.020	0.039	0.51	0.99
c	0.012	0.029	0.30	0.74
c2	0.045	0.065	1.14	1.65
D	0.330	0.380	8.38	9.65
D1	0.260	-----	6.60	-----
E	0.380	0.420	9.65	10.67
E1	0.245	-----	6.22	-----
e	0.100 BSC		2.54 BSC	
H	0.575	0.625	14.60	15.88
L	0.070	0.110	1.78	2.79
L1	-----	0.066	-----	1.68
L2	-----	0.070	-----	1.78
L3	0.010 BSC		0.25 BSC	
M	0°	8°	0°	8°

VIEW A-A
OPTIONAL CONSTRUCTIONS

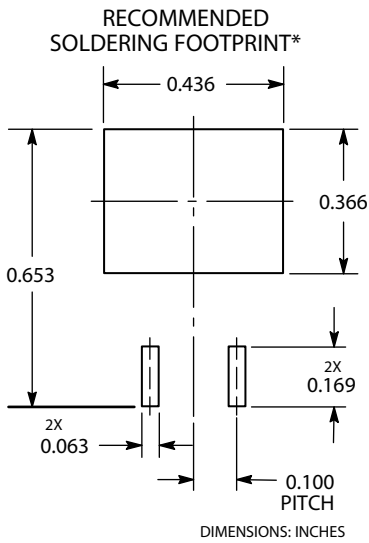

GENERIC MARKING DIAGRAMS*

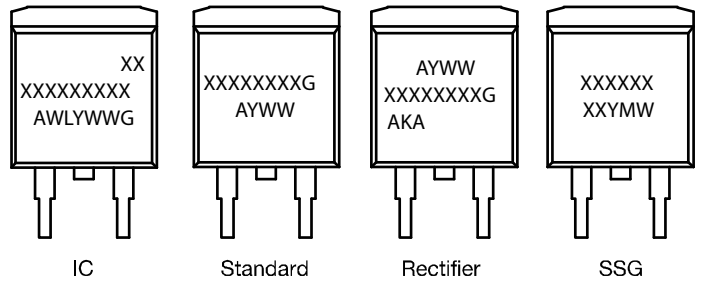

- XXXXXX = Specific Device Code
 A = Assembly Location
 WL = Wafer Lot
 Y = Year
 WW = Work Week
 W = Week Code (SSG)
 M = Month Code (SSG)
 G = Pb-Free Package
 AKA = Polarity Indicator

*For additional information on our Pb-Free strategy and soldering details, please download the ON Semiconductor Soldering and Mounting Techniques Reference Manual, SOLDERRM/D.

*This information is generic. Please refer to device data sheet for actual part marking. Pb-Free indicator, "G" or microdot "▪", may or may not be present.

Note on usage : Since the NDBA170N06A is a MOSFET product, please avoid using this device in the vicinity of highly charged objects.

ON Semiconductor and the ON logo are registered trademarks of Semiconductor Components Industries, LLC (SCILLC). SCILLC owns the rights to a number of patents, trademarks, copyrights, trade secrets, and other intellectual property. A listing of SCILLC's product/patent coverage may be accessed at www.onsemi.com/site/pdf/Patent-Marking.pdf. SCILLC reserves the right to make changes without further notice to any products herein. SCILLC makes no warranty, representation or guarantee regarding the suitability of its products for any particular purpose, nor does SCILLC assume any liability arising out of the application or use of any product or circuit, and specifically disclaims any and all liability, including without limitation special, consequential or incidental damages. "Typical" parameters which may be provided in SCILLC data sheets and/or specifications can and do vary in different applications and actual performance may vary over time. All operating parameters, including "Typicals" must be validated for each customer application by customer's technical experts. SCILLC does not convey any license under its patent rights nor the rights of others. SCILLC products are not designed, intended, or authorized for use as components in systems intended for surgical implant into the body, or other applications intended to support or sustain life, or for any other application in which the failure of the SCILLC product could create a situation where personal injury or death may occur. Should Buyer purchase or use SCILLC products for any such unintended or unauthorized application, Buyer shall indemnify and hold SCILLC and its officers, employees, subsidiaries, affiliates, and distributors harmless against all claims, costs, damages, and expenses, and reasonable attorney fees arising out of, directly or indirectly, any claim of personal injury or death associated with such unintended or unauthorized use, even if such claim alleges that SCILLC was negligent regarding the design or manufacture of the part. SCILLC is an Equal Opportunity/Affirmative Action Employer. This literature is subject to all applicable copyright laws and is not for resale in any manner.