

1. Mechanical Dimensions:

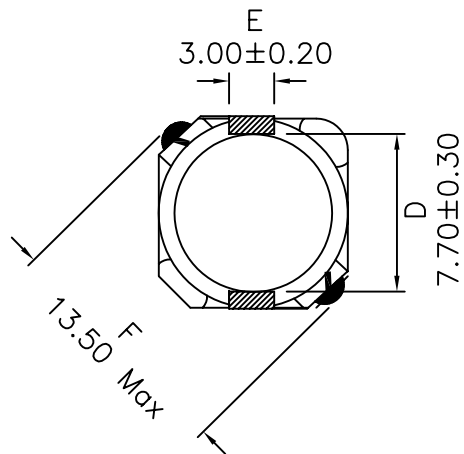

(Bottom View)

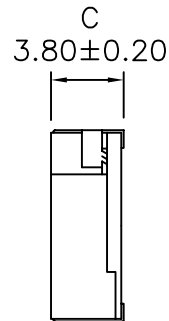
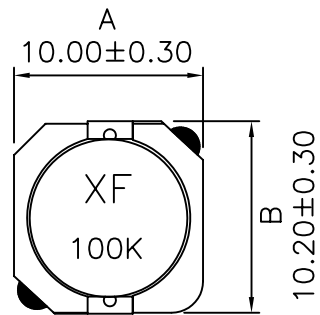
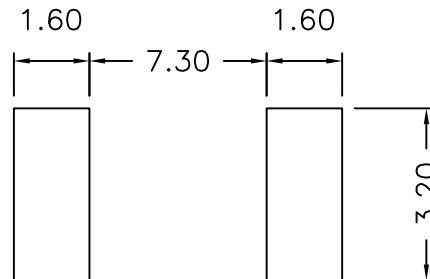

Suggested Pad Layout

2. Schematic:

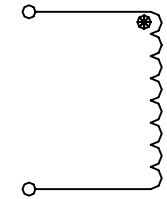

3. Electrical Specification:

OCL: 10.0uH ± 10% @ 100KHz 0.1V

OCL: 8.1uH Min @ 100KHz 0.1V, 4.40 Adc

DCR: 0.035 Ohms Max

Notes:

1. Solderability: Leads shall meet MIL-STD-202, Method 208D for solderability.
2. Flammability: UL94V-0
3. ASTM oxygen index: > 28%
4. Insulation System: Class F 155°C. UL file E151556
5. Operating Temperature Range: -40°C to +85°C
6. Storage Temperature Range: -55°C to +125°C
7. Aqueous wash compatible

XFMRs Inc. UNLESS OTHERWISE SPECIFIED TOLERANCES: .xx ± 0.25 Dimensions in MM	Title: HIGH CURRENT SELF-LEADED SMT INDUCTORS		
	P/N: XFTPRH104-100K		REV. A
	DWN.	Kang Chen	Nov-19-03
	CHK.	YK Liao	Nov-19-03
APP.	MS	Nov-19-03	

DOC REV: A/2