



PART NUMBER: CMS0321KLX

DESCRIPTION: SPEAKER

SPECIFICATIONS

parameter	conditions/description	min	nom	max	units
nominal size	32 x 32 x 14.5H mm				
impedance	at 1 kHz, 1 V	6.8	8	9.2	Ω
resonant frequency	at 1 V	240	300	360	Hz
sound pressure level	1 W, 50 cm ave., at 0.4, 0.5, 0.6, 0.8 kHz	83	86	89	dB
response	10 dB max.	Fo		15,000	Hz
input power			2	4	W
operation	must be normal at program source		2		W
buzz, rattle, etc.	must be normal at sine wave		4		V dc
magnet	size: 18.7 x 4 mm				
load test	24 hours of white noise at		2		W
heat test	20 ~ 50% RH for 24 hours	58	60	62	$^{\circ}$ C
humidity test	90 ~ 95% RH for 24 hours	38	40	42	$^{\circ}$ C
RoHS	yes				

FREQUENCY RESPONSE CURVE

parameter	conditions/description
potentiometer range	50 dB
rectifier	RMS
lower limit frequency	20 Hz
wr. speed	100 mm/sec
zero level	60 dB

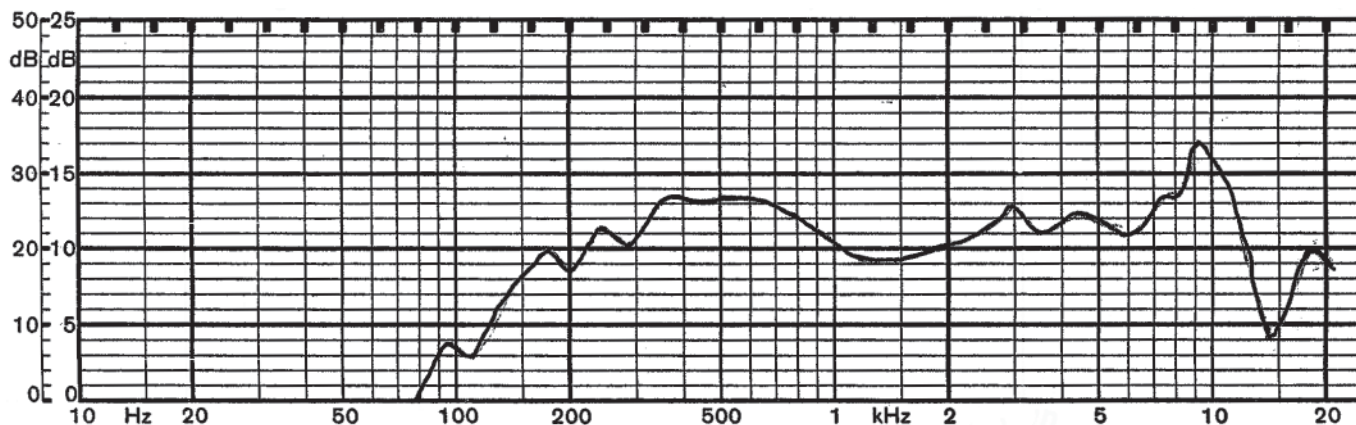

REV.	DESCRIPTION	DATE
A	NEW DRAWING	7/25/2007
B	base thickness changed from 3.0mm to 3.8mm	5/5/2008

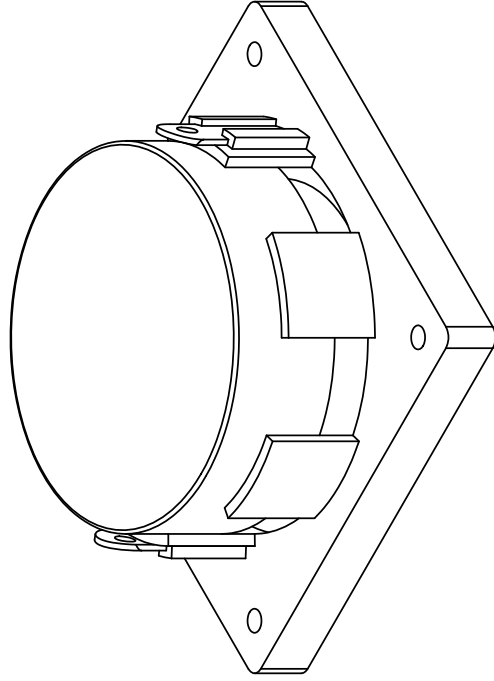
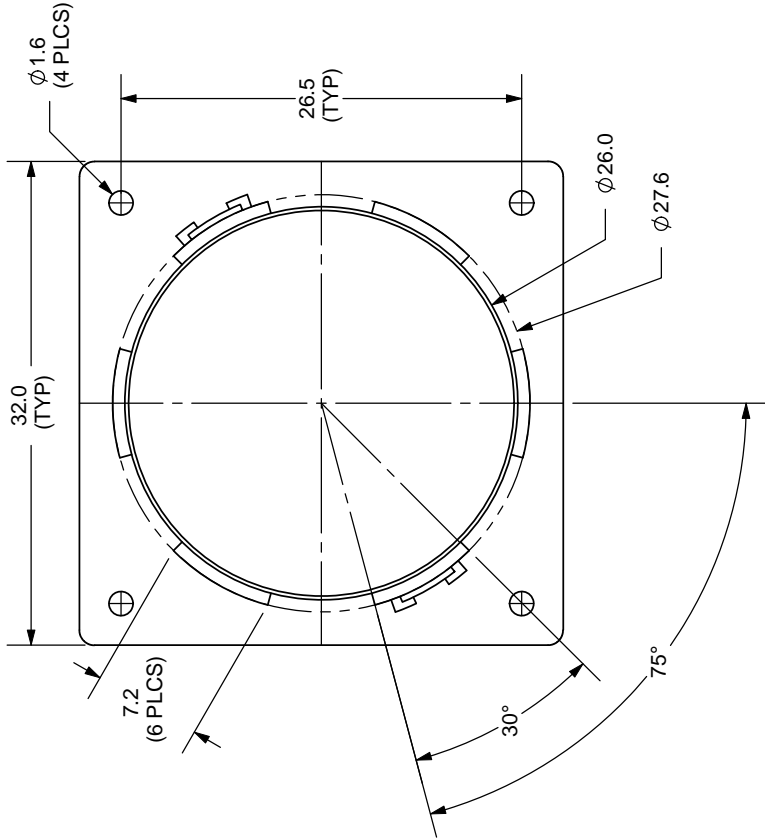

TOLERANCE:
±0.2mm UNLESS OTHERWISE
SPECIFIED



CUI INC

20050 SW 112th Ave.
Tualatin, OR 97062
Phone: 503-612-2300
800-275-4899
Fax: 503-612-2383
Website: www.cui.com

TITLE: MINIATURE MONITOR SPEAKER	REV: B
PART NO: CMS0321KLX	UNITS: MM [INCHES]
DRAWN BY: ZRJ	APPROVED BY:
	SCALE: 2:1

