

DETAILS

Product Number	CA14507_G2-LXP2-D-P
Family	Leila
Type	Assembly
Color	black
Diameter	21,8 mm
Height	14,7 mm
Style	round
Optic Material	
Holder Material	
Fastening	tape, pin
Status	production ready
ROHS Compliant	Yes
Date Updated	30/05/2016



OPTICAL PROPERTIES

LED	Viewing	Light	Effi-		Connector
	Angle	Beam	ciency	cd/lm	
XP-E	9,7 deg	Diffuser	88 %	19.850	-
XP-G2	sim: 10	Diffuser	sim: 94 %	sim: 24.200-	
XT-E	sim: 11	Diffuser	sim: 90 %	sim: 16.000-	
XP-G3	sim: 14	Diffuser	sim: 91 %	sim: 11.900-	
XD16	13 deg	Diffuser	78 %	7.400	-
H35C1 (LEMWA33)	sim: 12	Diffuser	sim: 92 %	sim: 15.600-	
LUXEON Z ES	14 deg	Diffuser	83 %	8.700	-
LUXEON T	sim: 12	Diffuser	sim: 93 %	sim: 14.300-	
LUXEON TX	sim: 11	Diffuser	sim: 92 %	sim: 15.400-	
LUXEON C	11 deg	Diffuser	80 %	11.000	-
LUXEON IR Compact	sim: 8	Diffuser	sim: 84 %	sim: 0.000	-
LUXEON V	18 deg	Diffuser	83 %	4.700	-
NCSxx19A	13 deg	Diffuser	86 %	9.000	-
NWSx229A	29 deg	Diffuser	83 %	4.600	-
NVSxx19B/NVSxx19C	sim: 13	Diffuser	sim: 89 %	sim: 12.000-	
NVSW3x9A	17 deg	Diffuser	81 %	6.100	-
Oslo Square Gen3	sim: 11	Diffuser	sim: 92 %	sim: 16.700-	
Oslo SSL 80	sim: 8,3	Diffuser	sim: 92 %	sim: 30.500-	
SFH 4770S	sim: 9	Diffuser	sim: 85 %	-	-
Oslo Square Flat	sim: 9,4	Diffuser	sim: 91 %	sim: 19.120-	
LH351B	sim: 12	Diffuser	sim: 92 %	sim: 13.000-	
LH351A(3535)	sim: 11	Diffuser	sim: 91 %	sim: 15.900-	
Z5P	sim: 10	Diffuser	sim: 92 %	sim: 17.500-	
Z5M1/Z5M2	sim: 12	Diffuser	sim: 93 %	sim: 15.200-	
Z8Y22P	15 deg	Diffuser	78 %	5.600	-



PRODUCT DATASHEET

Leila series

last update 30/5/2016

OPTICAL PROPERTIES

LED	Viewing Angle	Light Beam	Effi- ciency	cd/lm	Connector
-----	------------------	---------------	-----------------	-------	-----------

Relative intensity of CA14507_G2-LXP2-D-P_(XP-E)

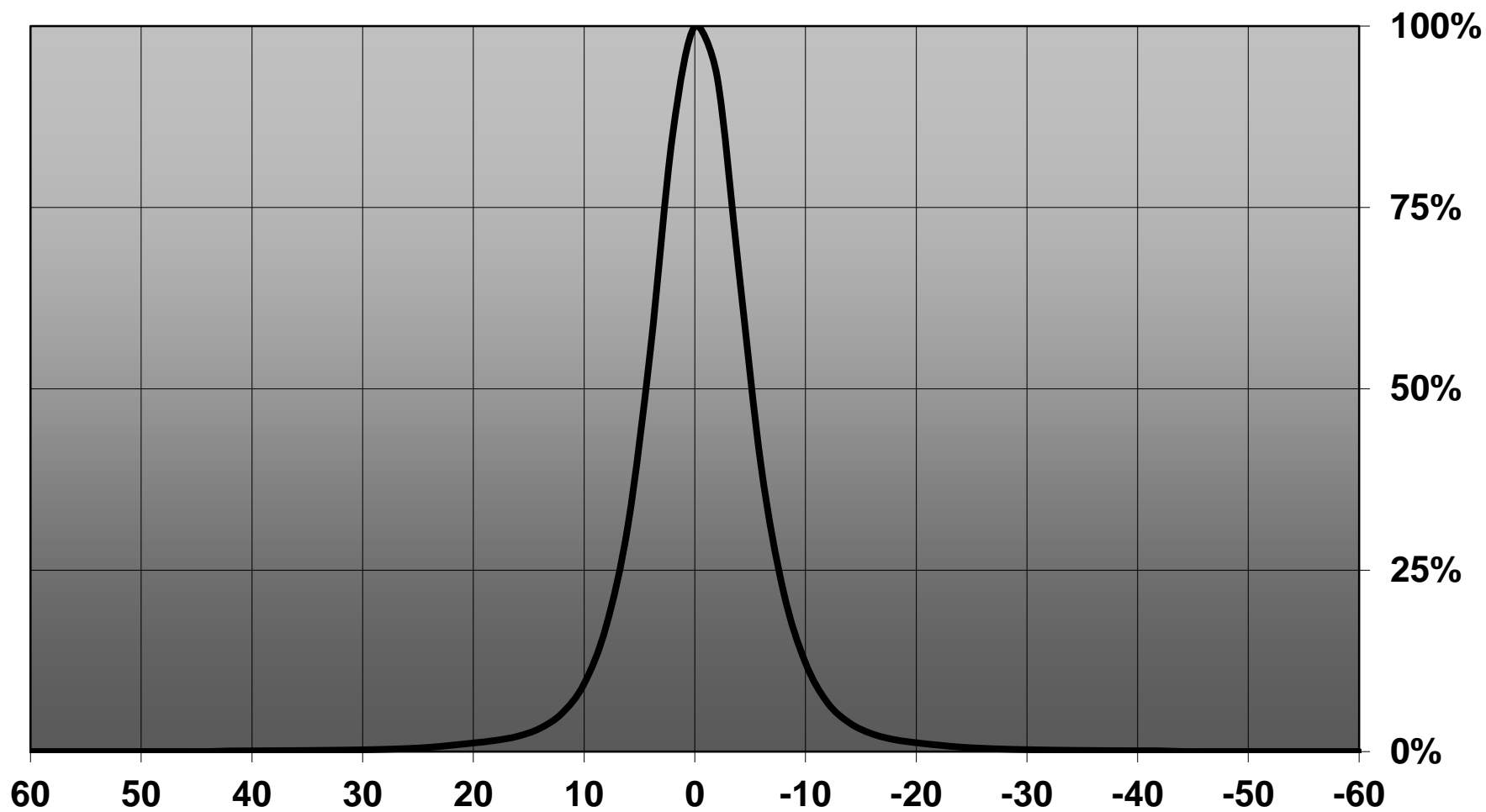

D

C

B

A

Applies to:
CA14503
CA14505
CA14507
CA14509
CA14511

4

4

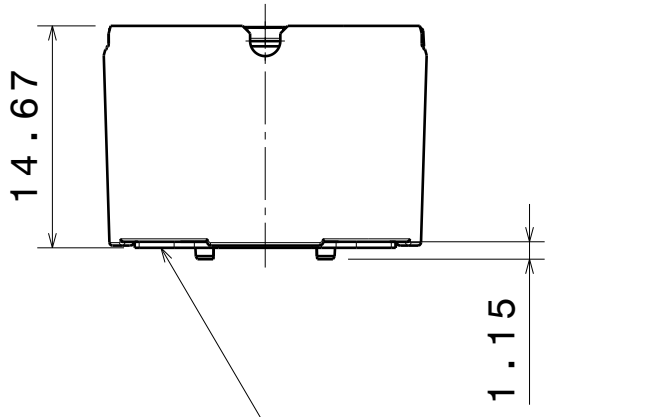

Front view

PU foam tape 0.4mm

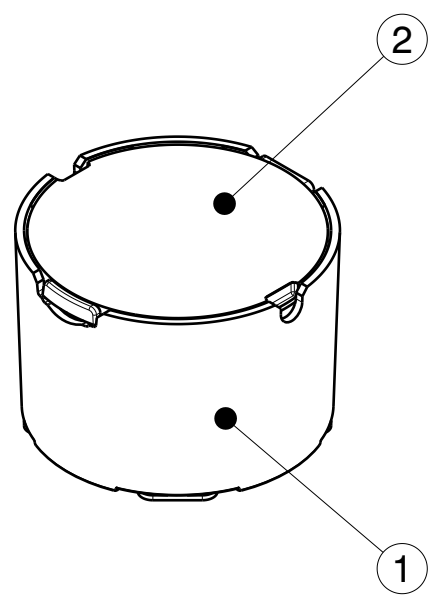

Isometric view

3

3

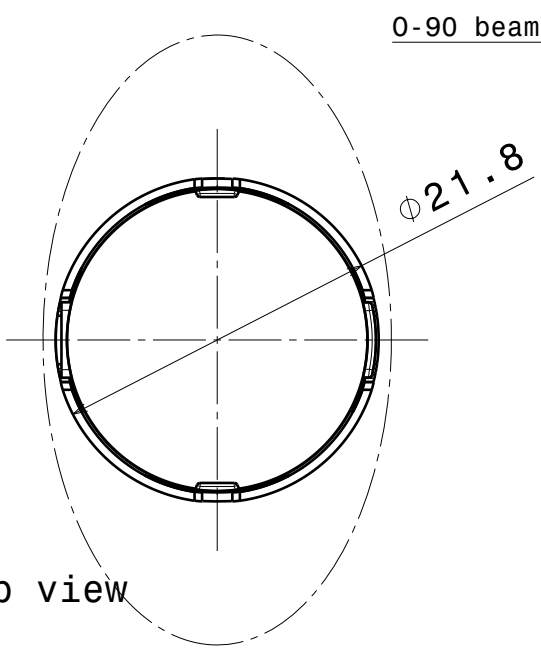

Top view

0-90 beam direction

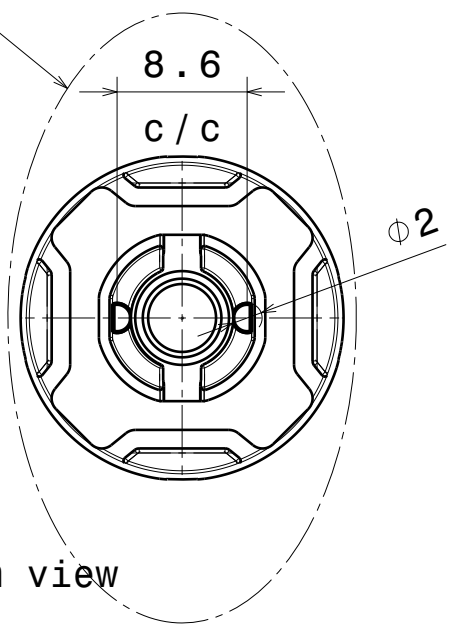

Bottom view

2

2

INDEX	PART NO	DESCRIPTION	MATERIAL	COLOUR
1	C14443	LXP2-LT-HLD	PC	black
2	-	LXP2-series_mech lens	PMMA	clear

Tolerances if not otherwise shown
 According to DIN ISO 2768-1
 Linear measures:
 up to 30mm class M, otherwise class C
 According to DIN ISO 2768-2
 Form and position: class L

LEDiL LediL Oy
 Salorankatu 10
 FIN 24240 SALO
 Finland

THIRD ANGLE PROJECTION:

DRAWING TITLE
LEILA-G2-LXP2-PIN

This drawing is the property of LEDiL Oy. It may not be reproduced, copied or communicated without a written agreement with LEDiL Oy.

SIZE	PART NUMBER
A4	-

SCALE	2:1	WEIGHT	4,0 g	SHEET	1/1
-------	-----	--------	-------	-------	-----

1

1

D

A

Luminaire: Ledil Oy CA14507_G2-LXP2-D-P_XP-G2_SIMULATED
Lamps: 1 x CREE XP-G2

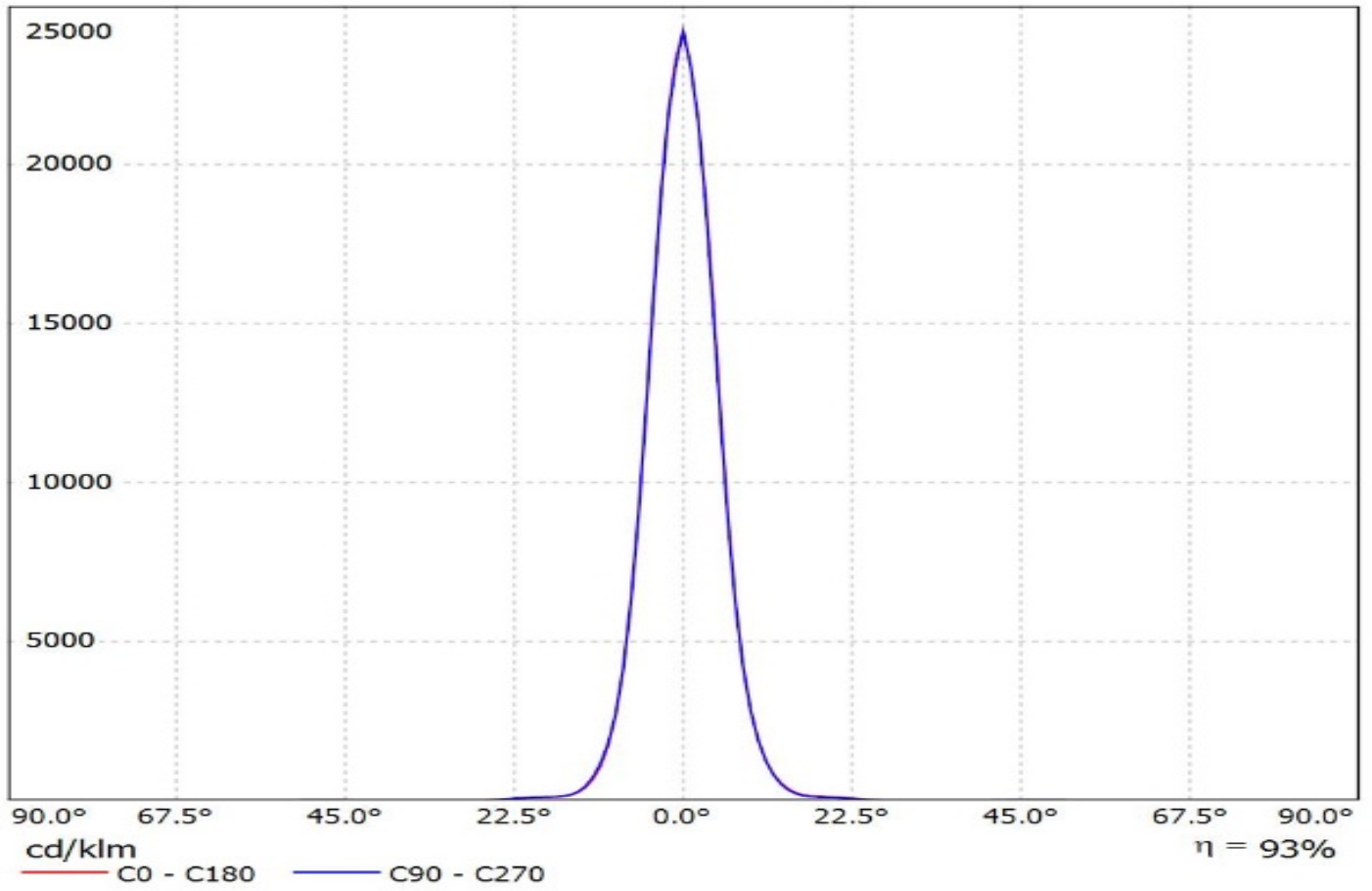

Luminaire: Ledil Oy CA14507_G2-LXP2-D-P_(XT-E)_SIMULATED
Lamps: 1 x Cree XT-E

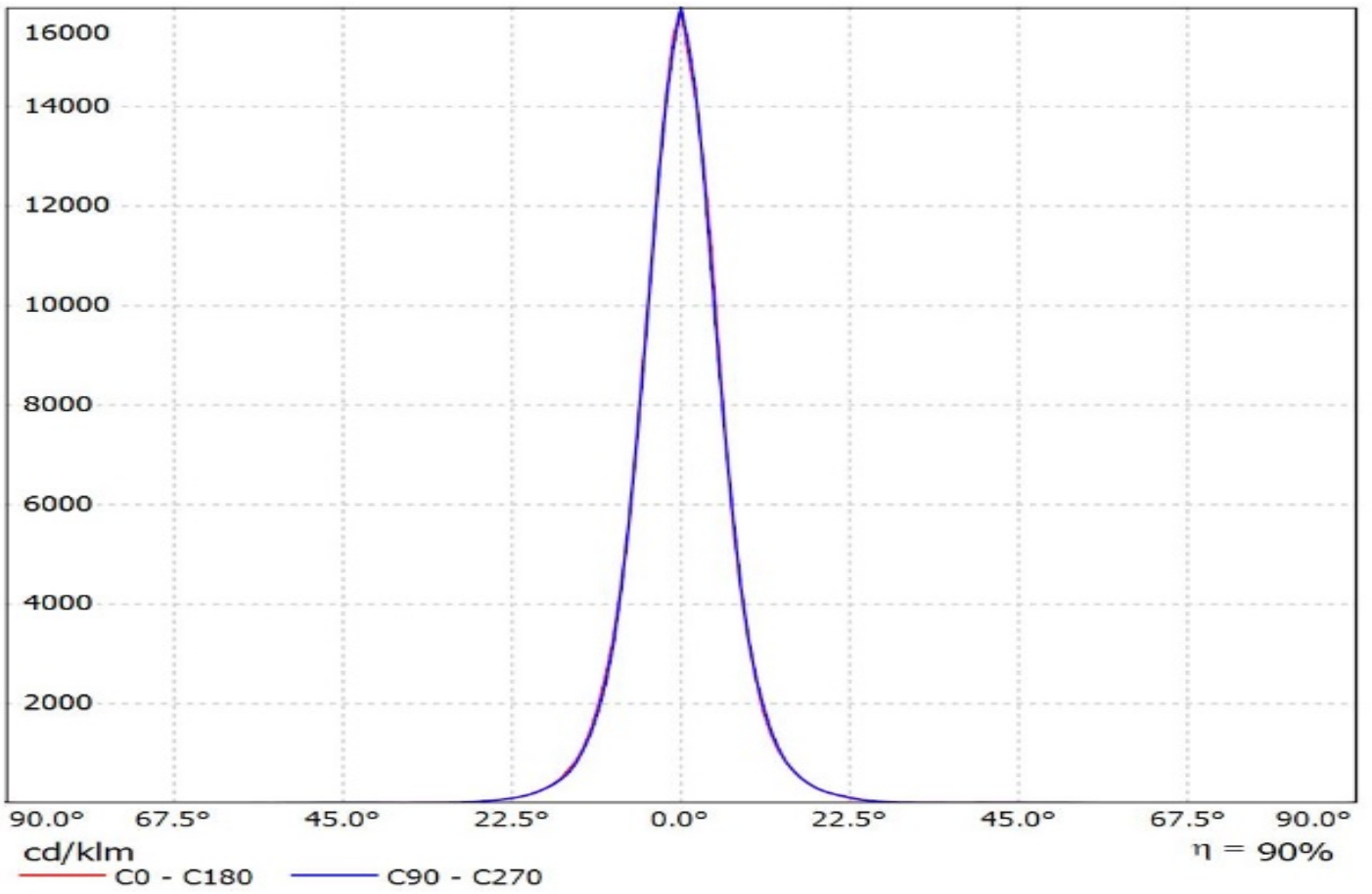

Luminaire: Ledil Oy CA14507_G2-LXP2-D-P_(XP-G3)_SIMULATED
Lamps: 1 x Cree XP-G3

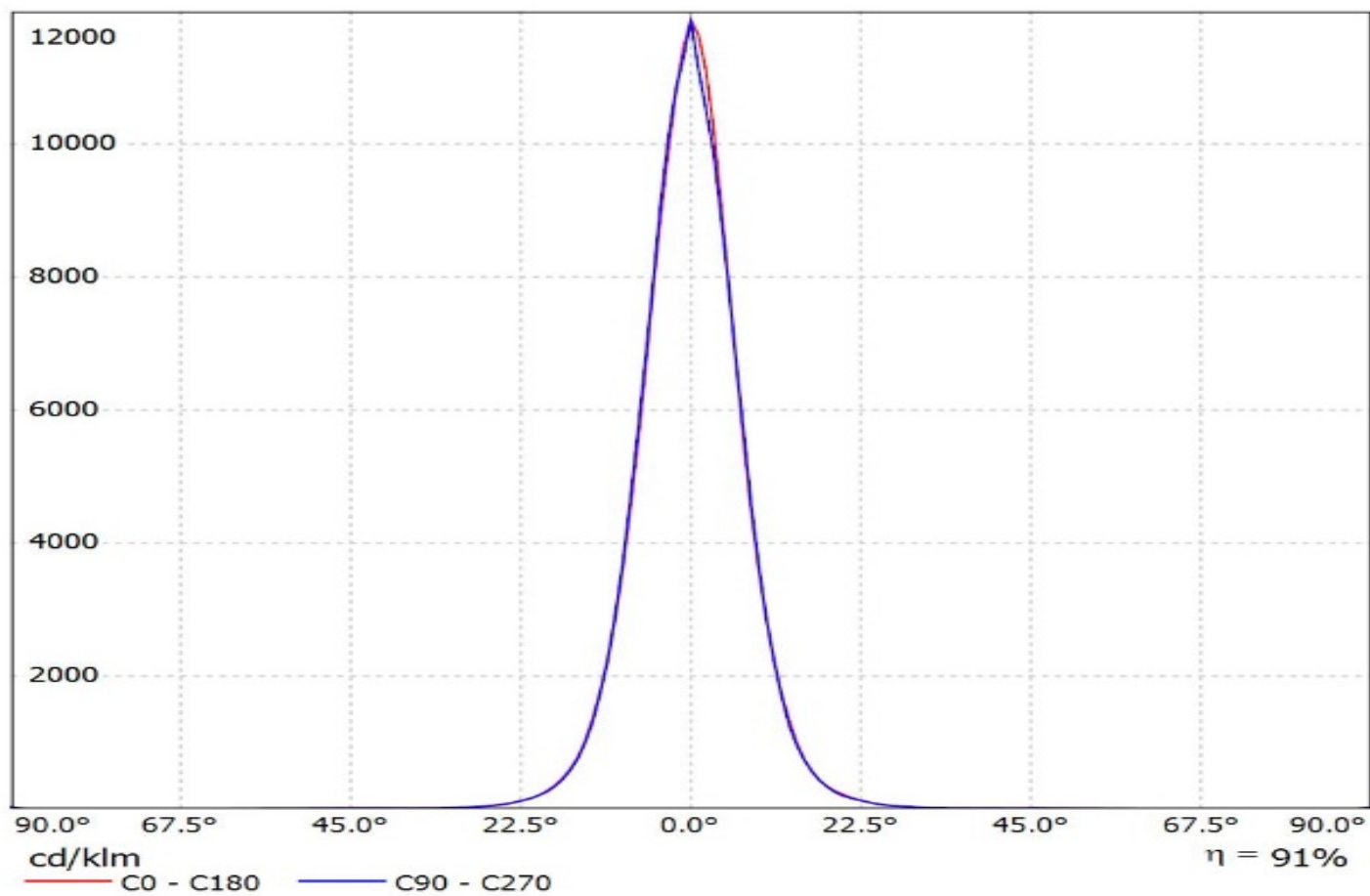

Luminaire: LEDiL Oy CA14507_G2-LXP2-D-P_(XD16)

Lamps: 1 x Cree_XD16_(XD16AWT-H-2B0-S20-0B-002)_115.272lm@250mA_CCT=5700K_P=0.707833W_U=2.8336V

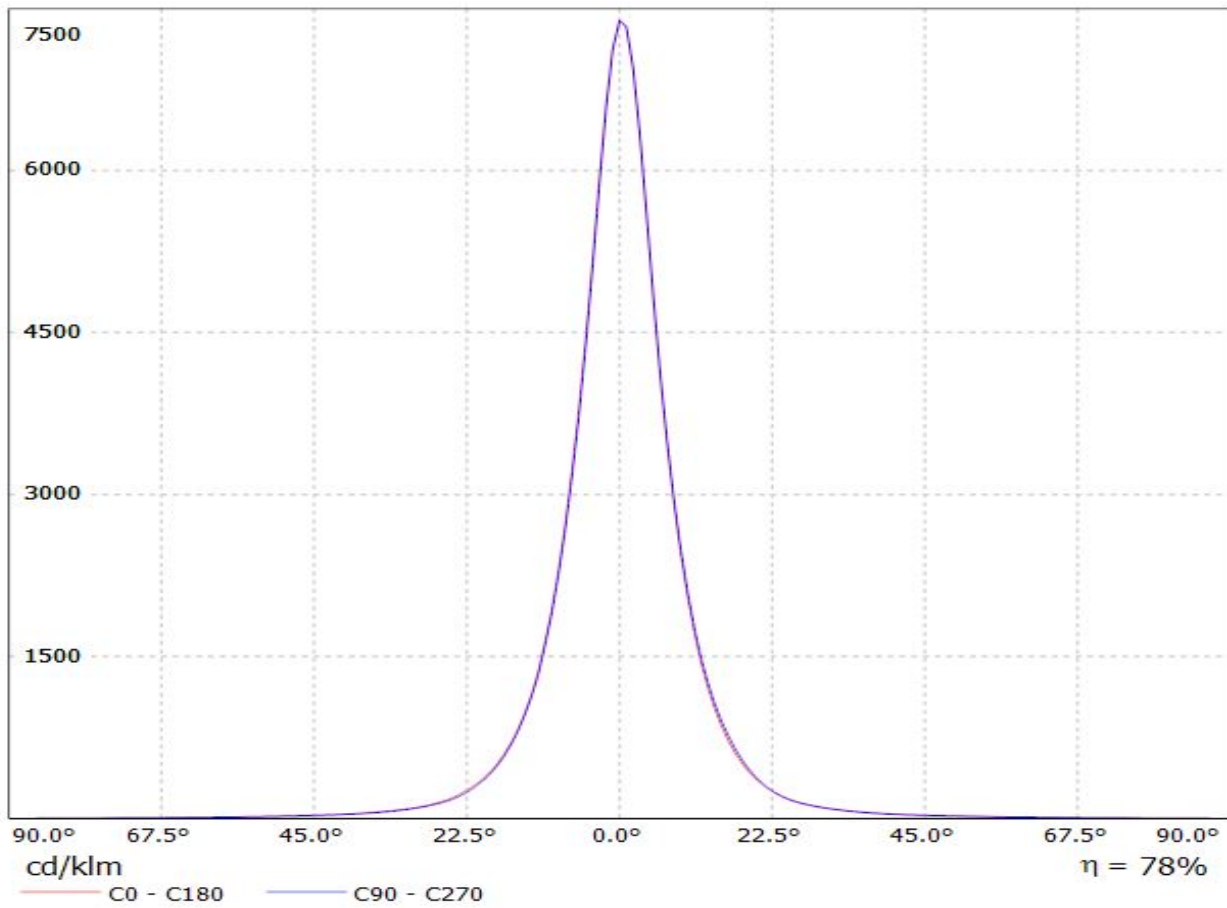

Luminaire: Ledil Oy CA14507_G2-LXP2-D-P_(LG_H35C1)_SIMULATED
Lamps: 1 x LG H35C1

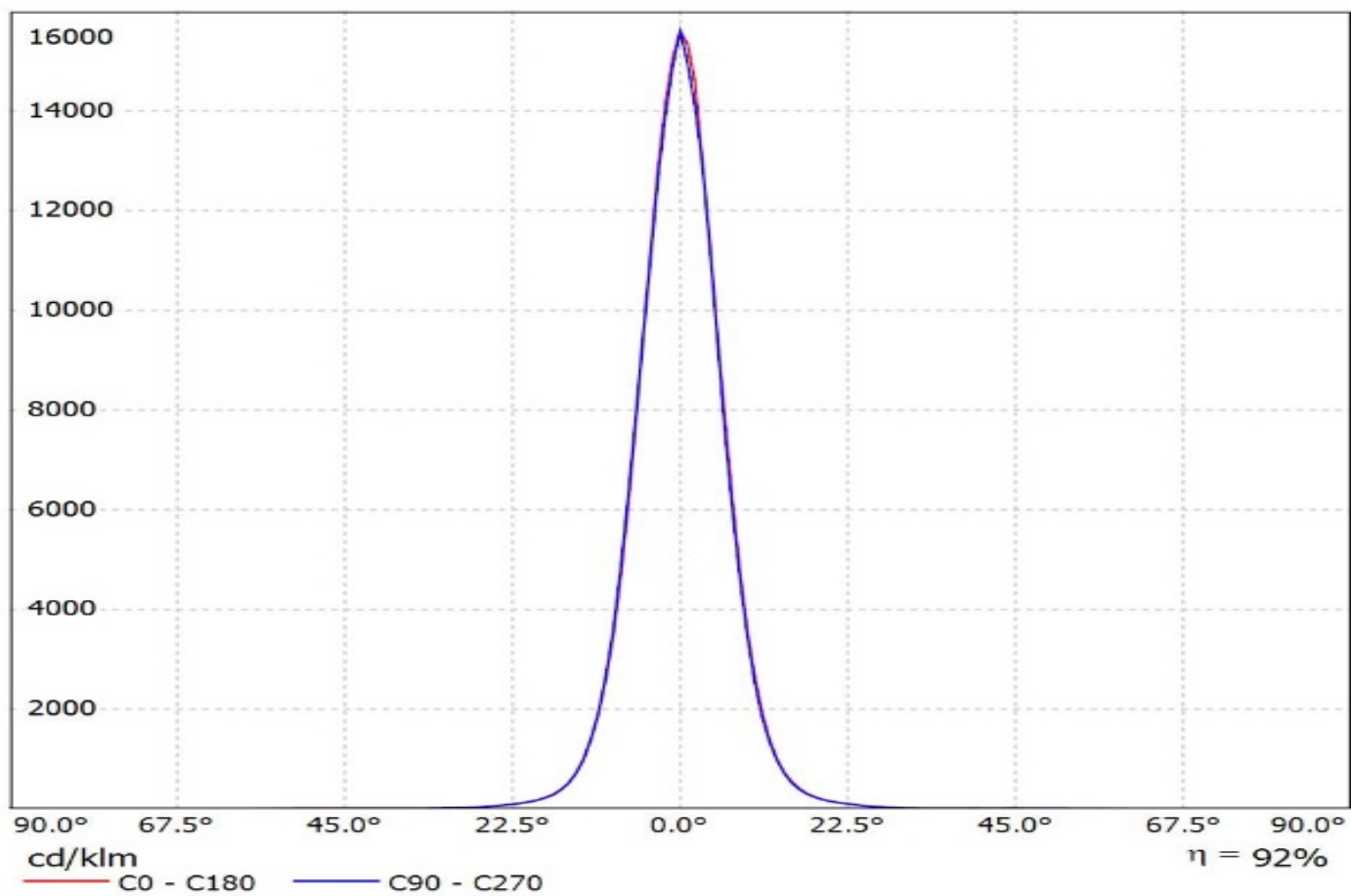

Luminaire: LEDiL Oy
Lamps: 1 x CA14507_G2-LXP2-D-P_(LUXEON_Z-ES)

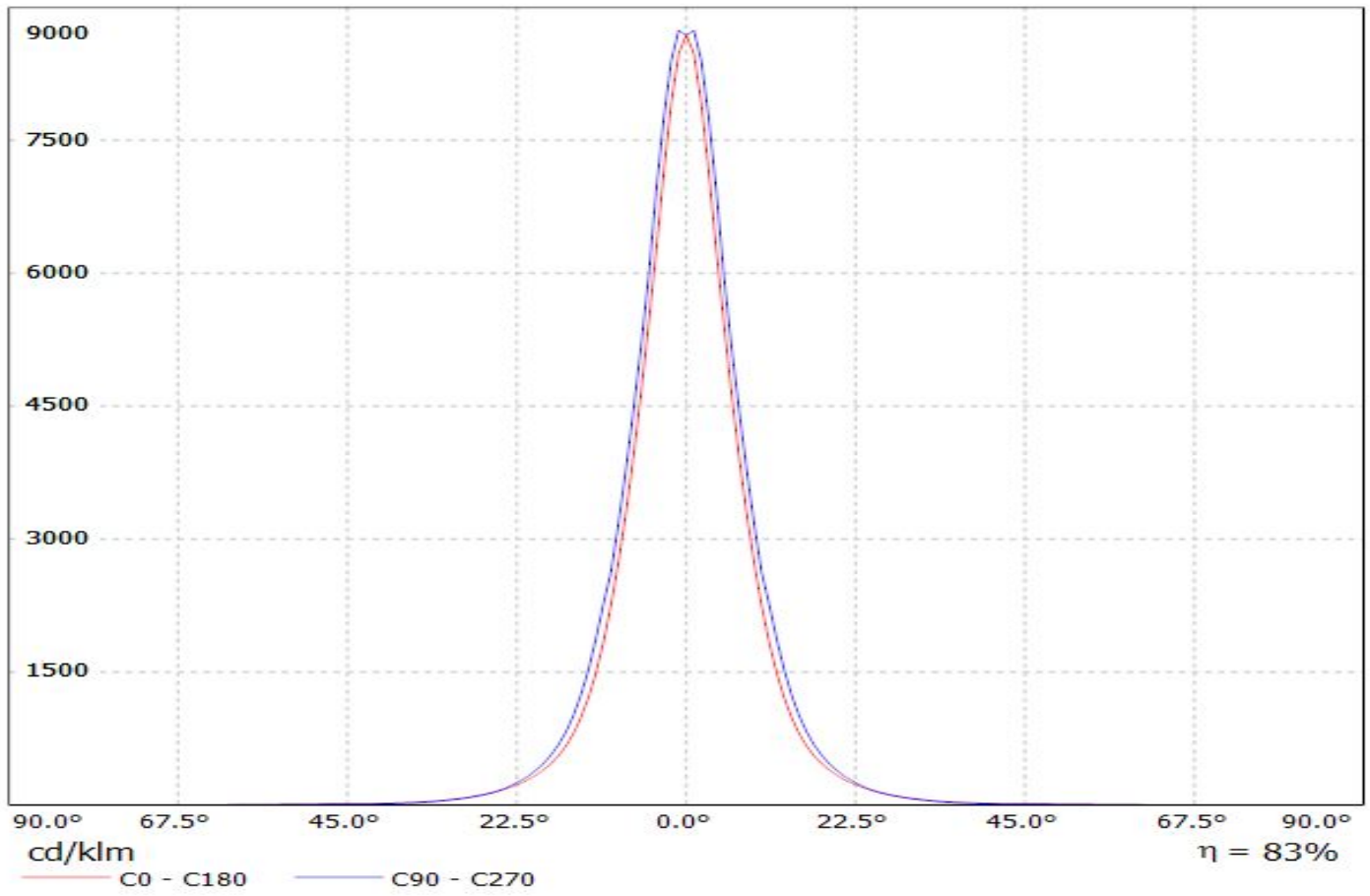

Luminaire: Ledil Oy CA14507_G2-LXP2-D-P_(Luxeon_T)_SIMULATED
Lamps: 1 x Lumileds Luxeon T

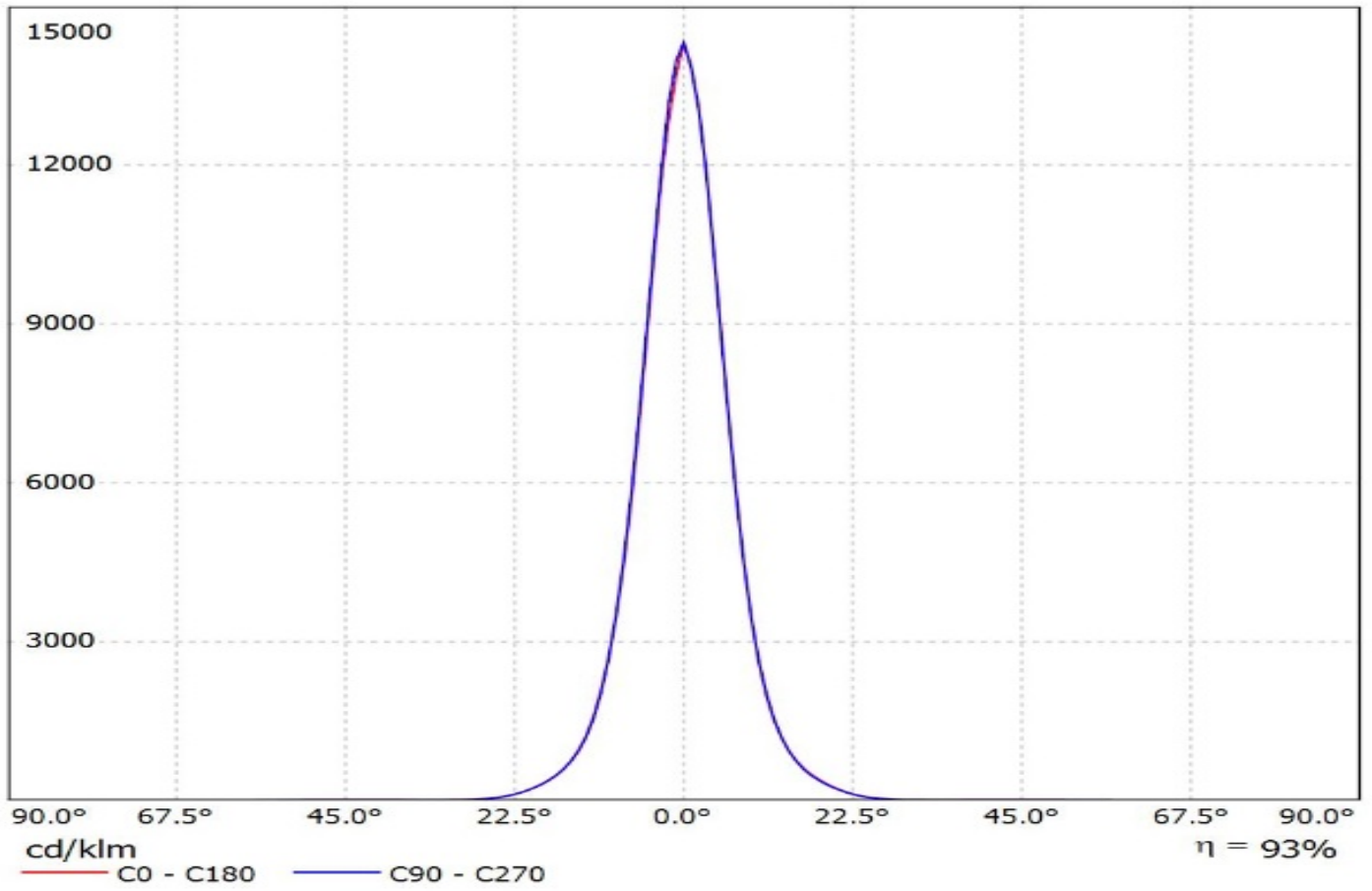

Luminaire: Ledil Oy CA14507_G2-LXP2-D-P_(Luxeon_TX)_SIMULATED
Lamps: 1 x Lumileds Luxeon TX

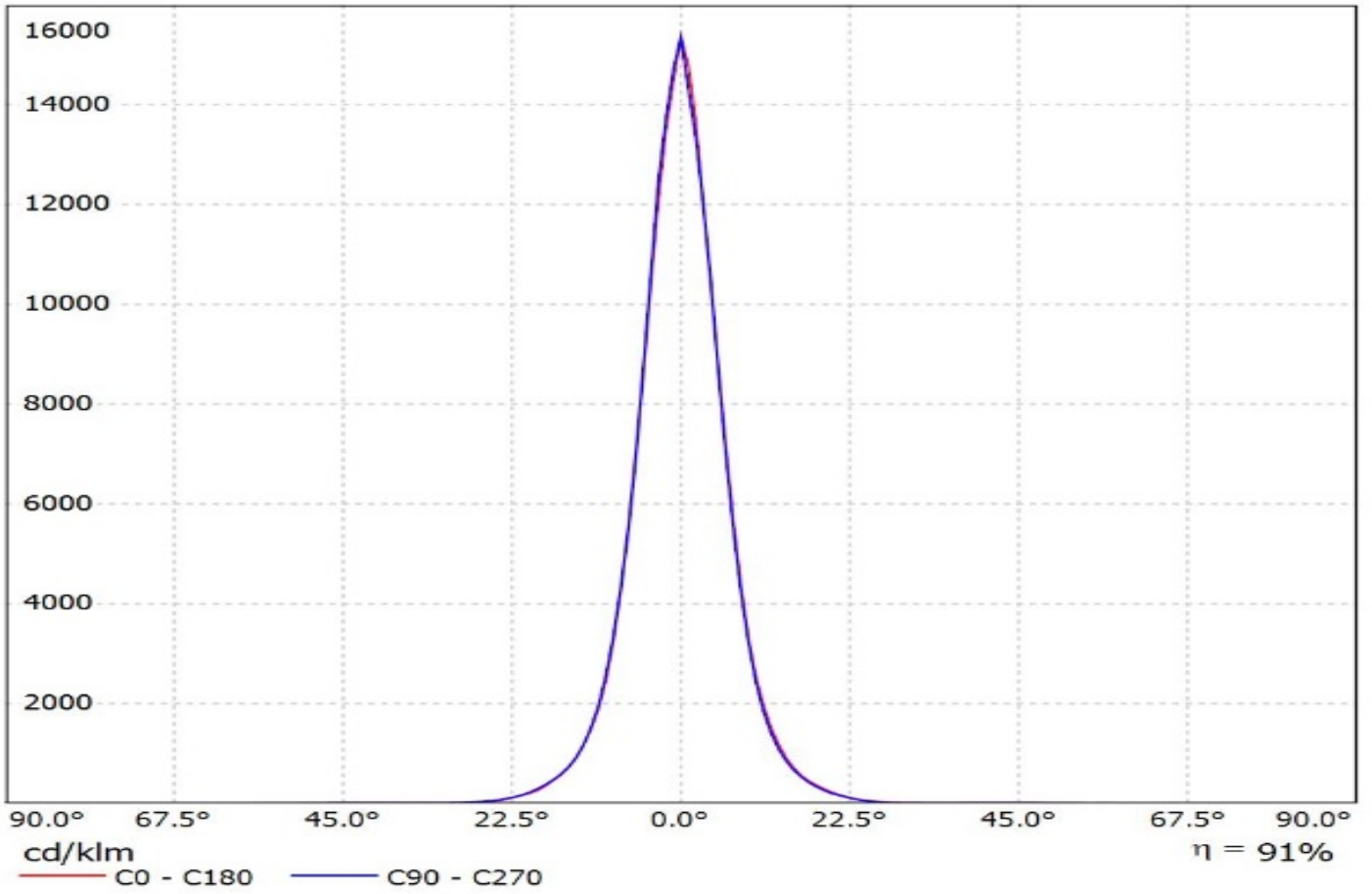

Luminaire: Ledil CA14507_G2-LXP2-D-P_(LUXEON_C)
Lamps: 1 x LUXEON_C_white_85.7286lm@250mA_P=0.7463W_I=0.250A

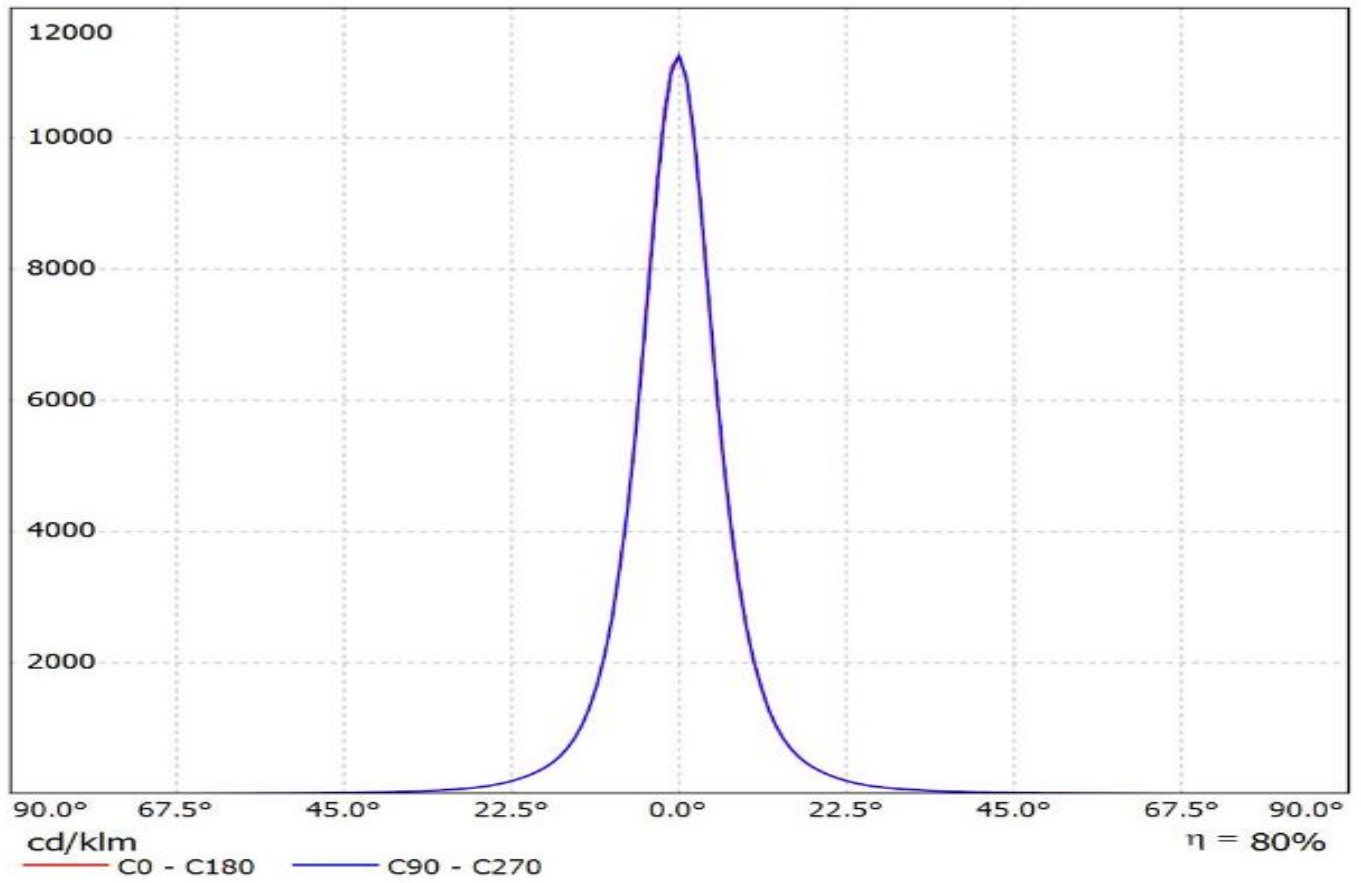

Luminaire: LEDiL Oy CA14507_G2-LXP2-D-P_(Luxeon_V)

Lamps: 1 x Lumileds_Luxeon_V_122.923lm@250mA_CCT=4000K_P=0.704836W_I=0.25A

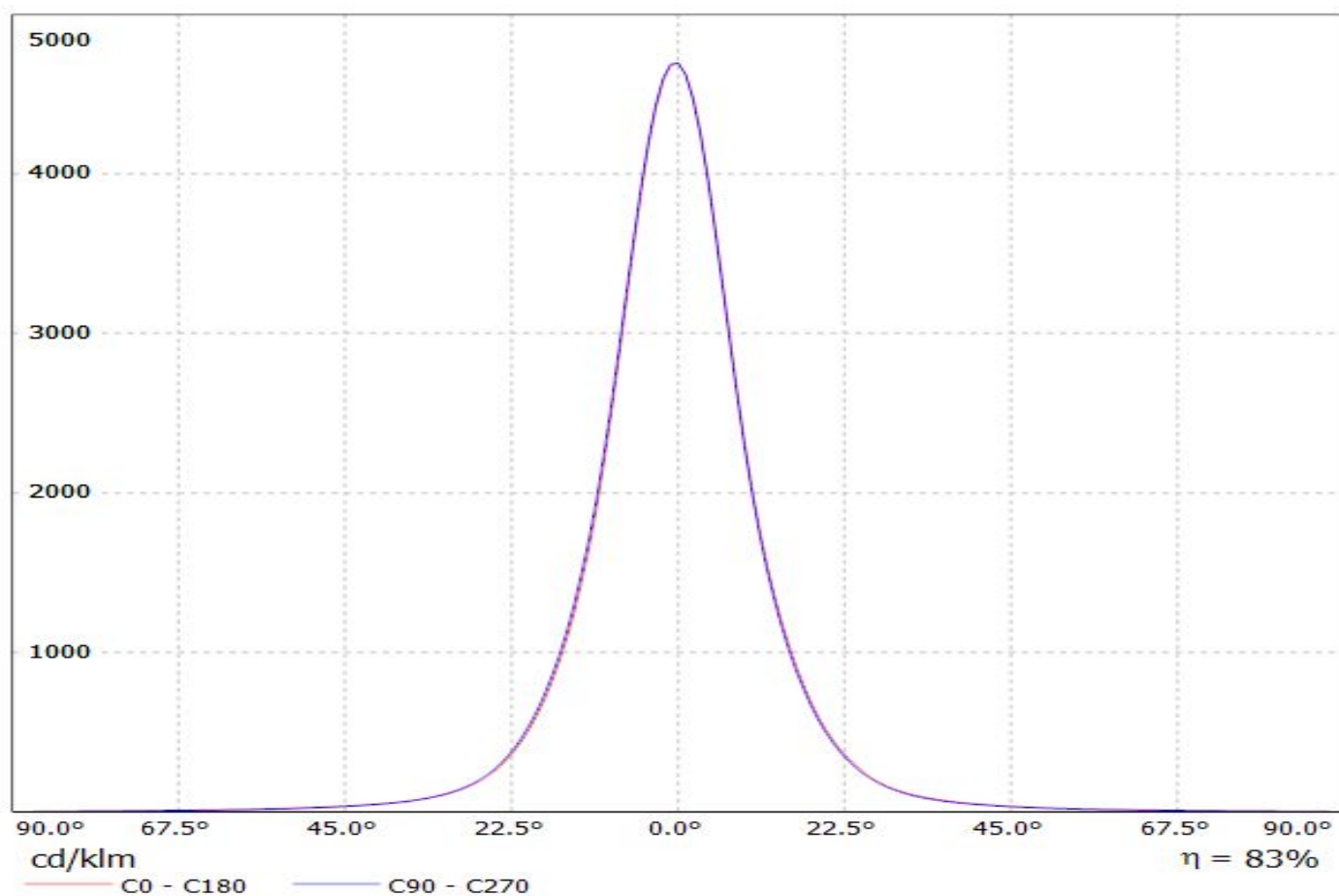

Luminaire: LEDiL Oy CA14507_G2-LXP2-D-P_(Nichia_NCSxx19A)
Lamps: 1 x Nichia_NCSxx19A_66.5093lm@250mA_P=0.78701W_I=0.2499A

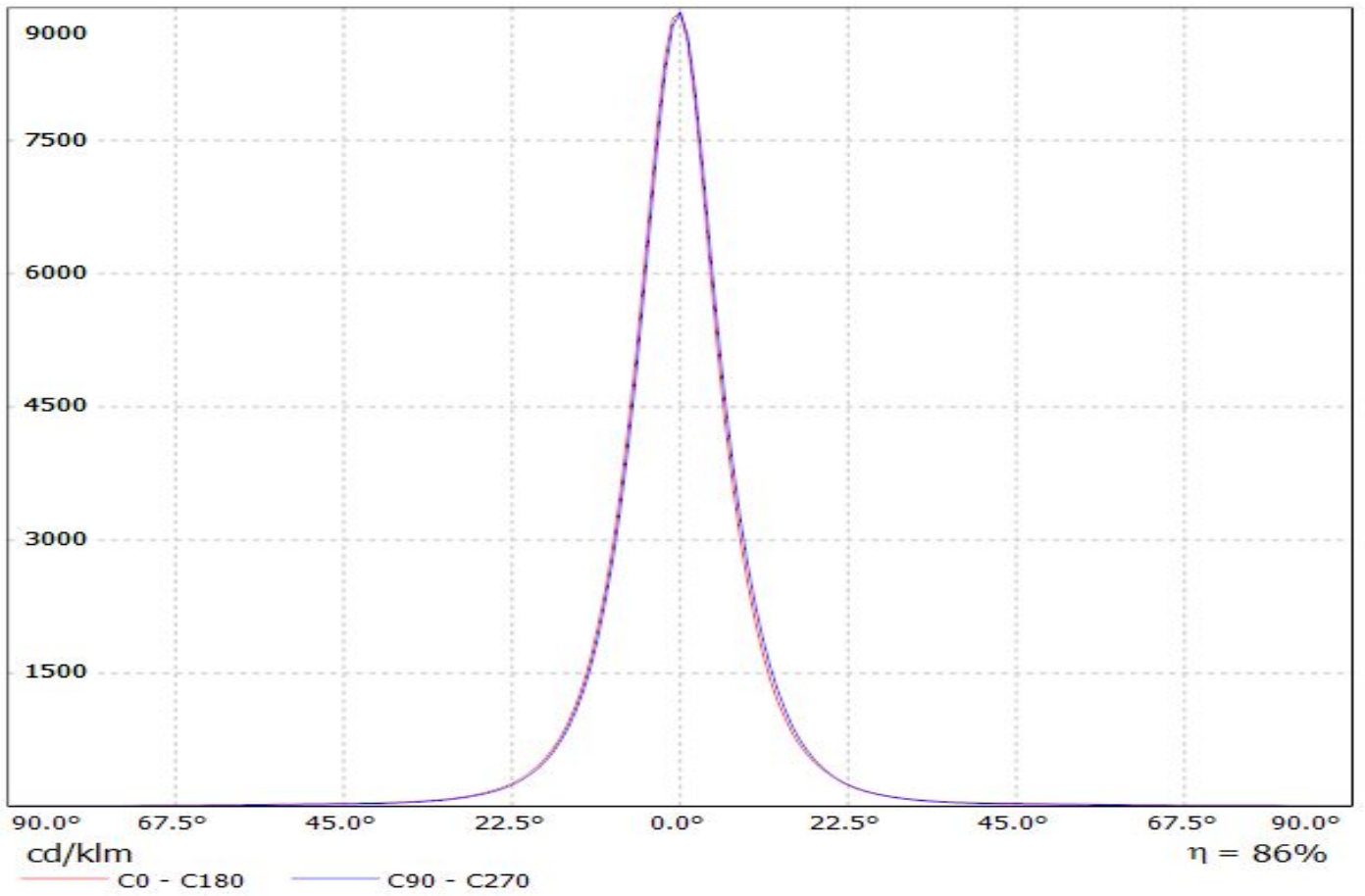

Luminaire: LEDiL Oy CA14507_G2-LXP2-D_(NWSL229AE)

Lamps: 1 x Nichia_NWSL229AE_120.54lm@250mA_P=0.7128W_I=0.250A

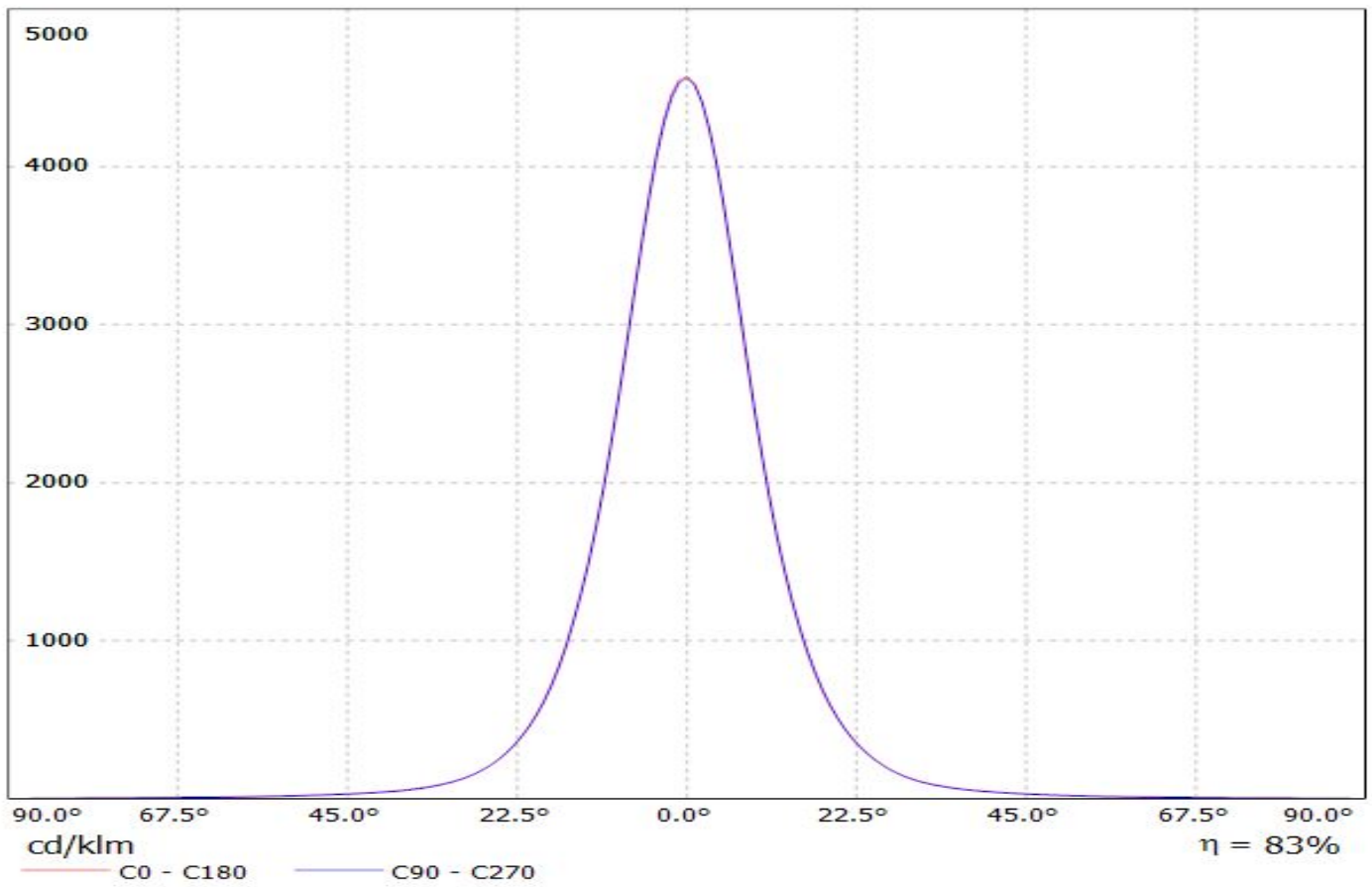

Luminaire: Ledil Oy CA14507_G2-LXP2-D-P_(NV5xx19B)_SIMULATED

Lamps: 1 x Nichia NV5xx19V (NVSW219B)

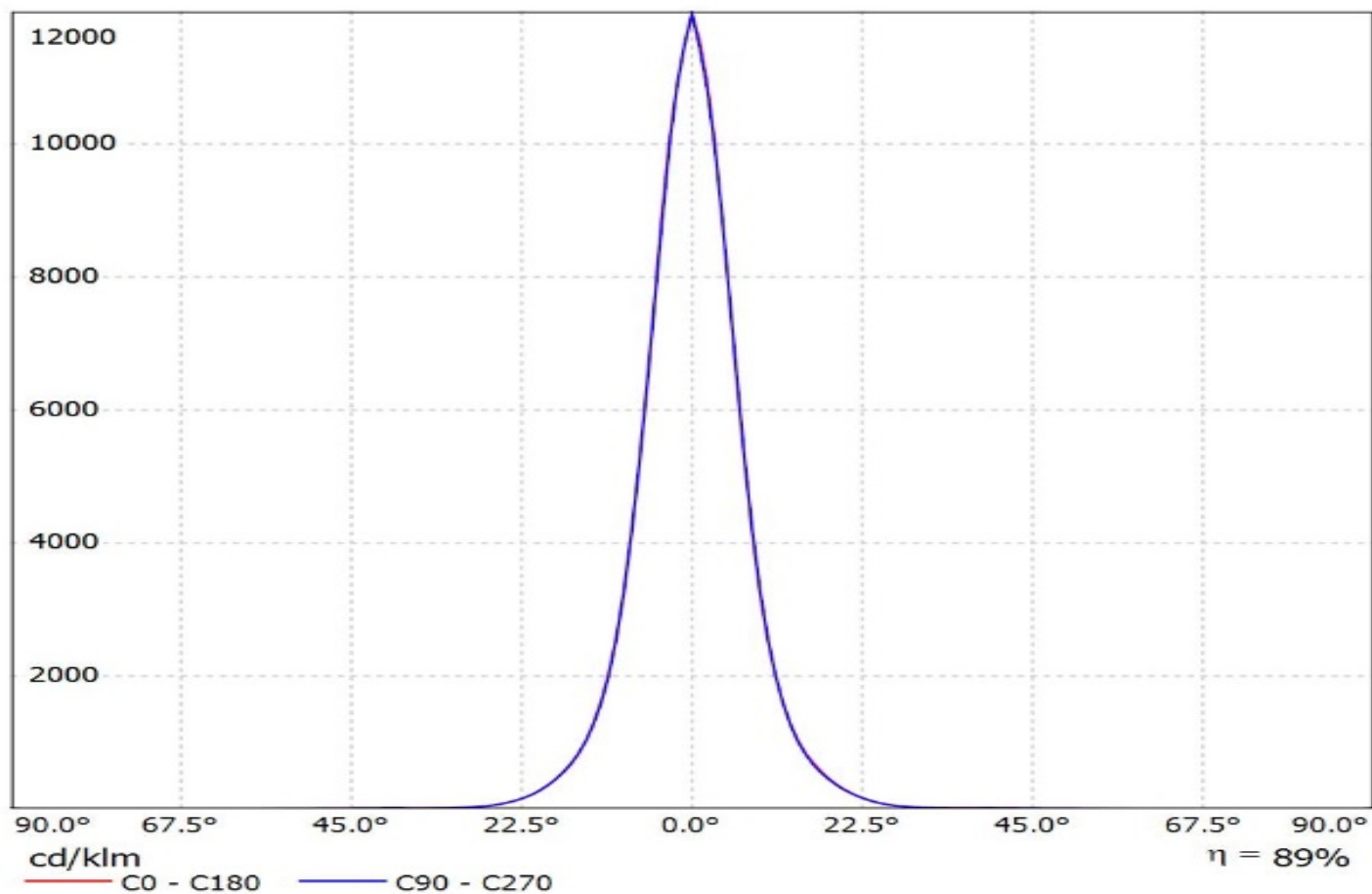

Luminaire: LEDiL Oy CA14507_G2-LXP2-D-P_(NVSW3x9A)

Lamps: 1 x Nichia_NVSW3x9A_(sm405/R70)_122.334lm@250mA_P=0.705435W_I=0.250A

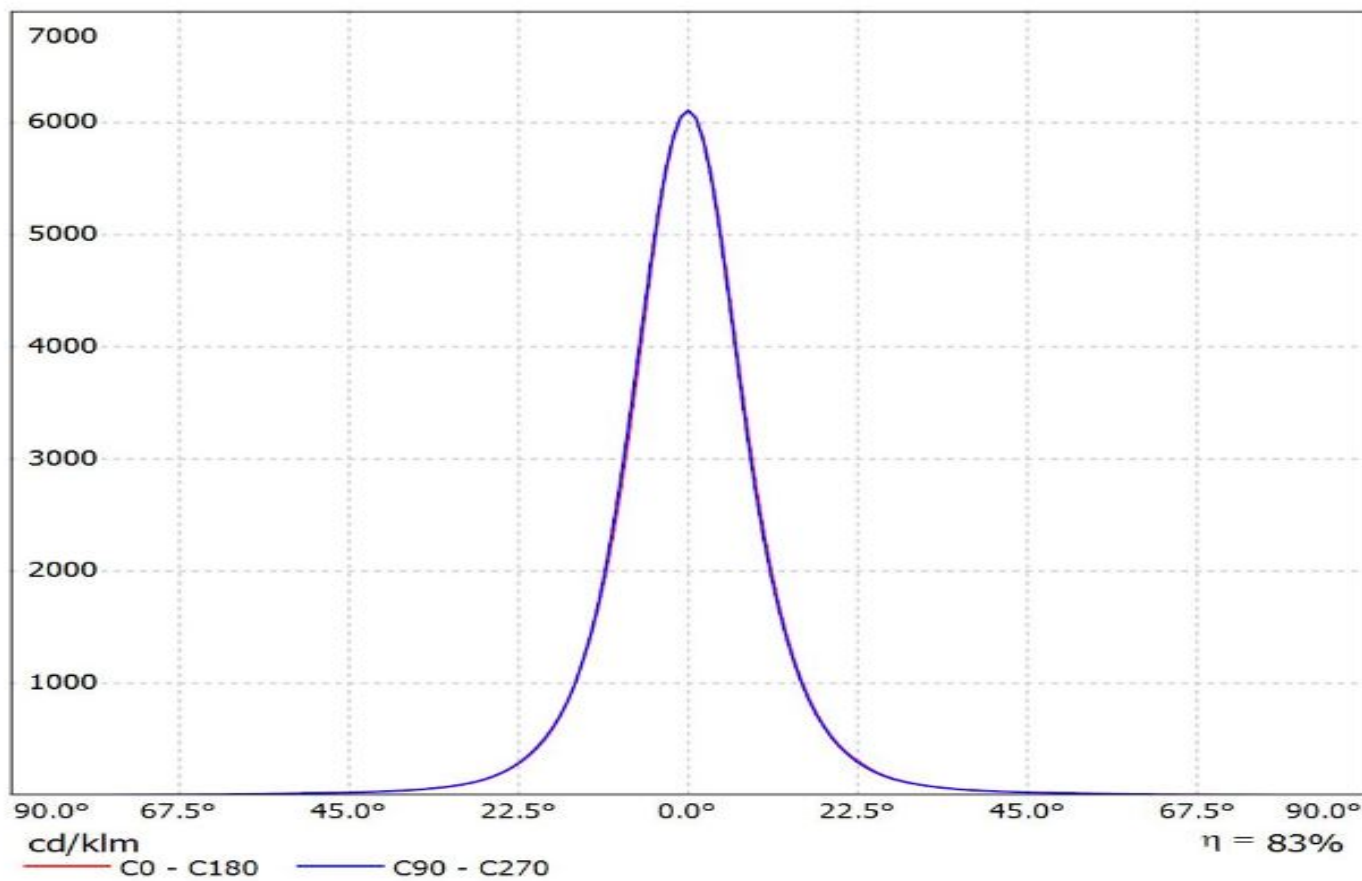

Luminaire: Ledil Oy CA14507_G2-LXP2-D-P_(Oslon_Square_Gen3)_SIMULATED
Lamps: 1 x Osram Oslon Square Gen 3 (GW_CSSRM2.PC)

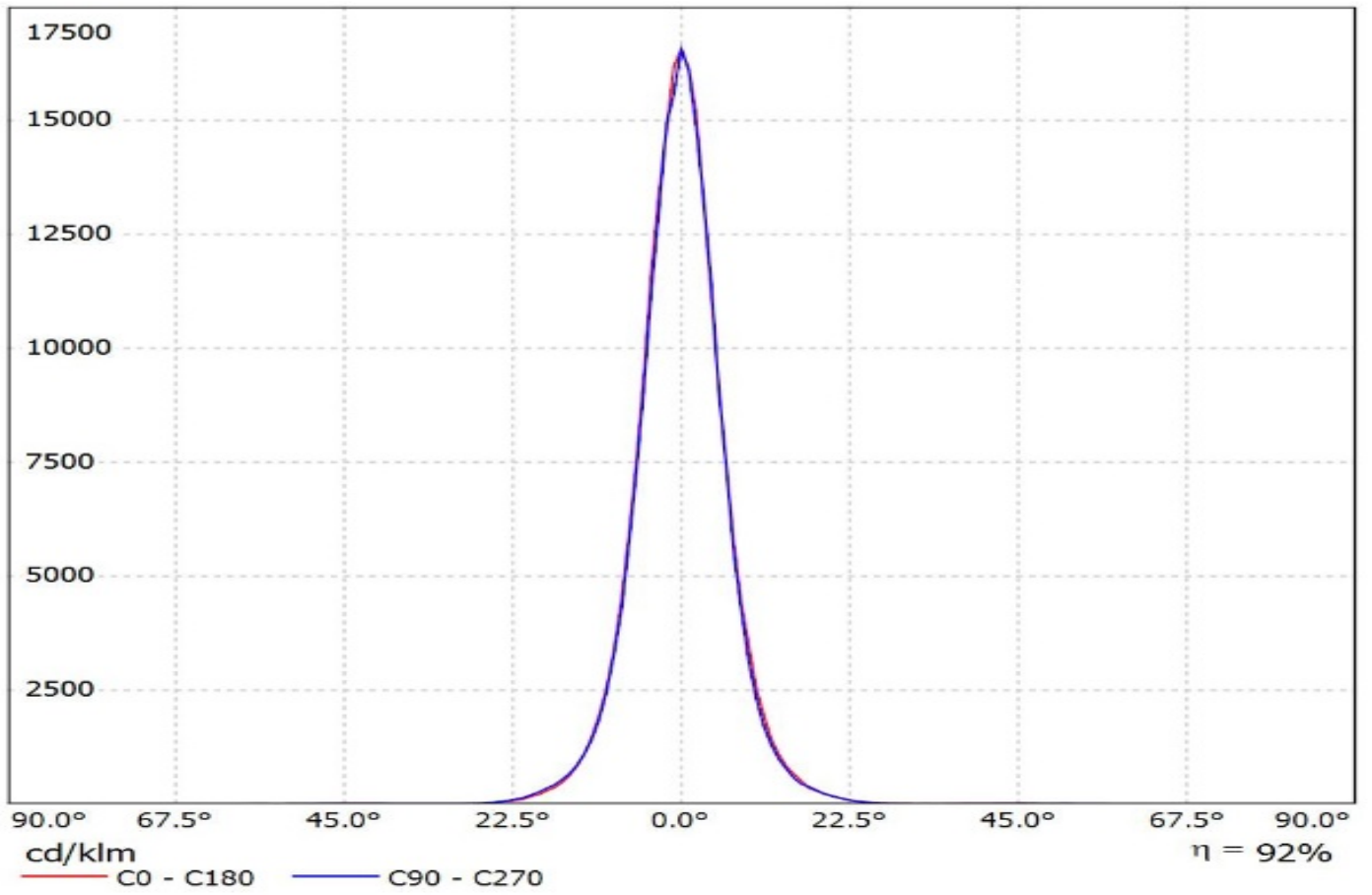

Luminaire: Ledil Oy CA14507_G2-LXP2-D-P_(Oslon_SSL_80)_SIMULATED
Lamps: 1 x Osram Oslon SSL 80 (LA CP7P)

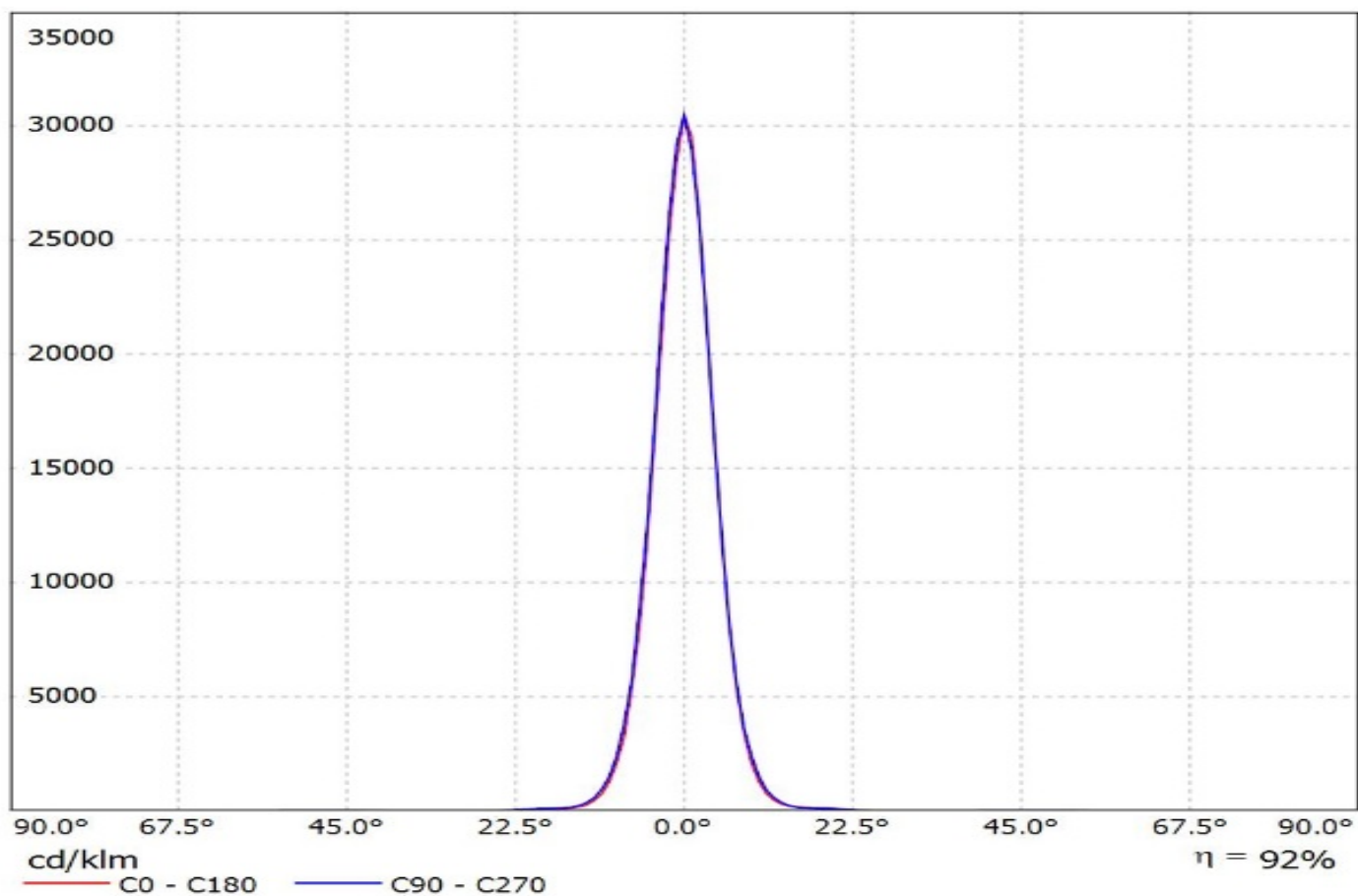

Luminaire: Ledil Oy CA14507_G2-LXP2-D-P_(OSRAM_OSLON_SQUARE_FLAT)_SIMULATED
Lamps: 1 x OSRAM_OSLON_SQUARE_FLAT

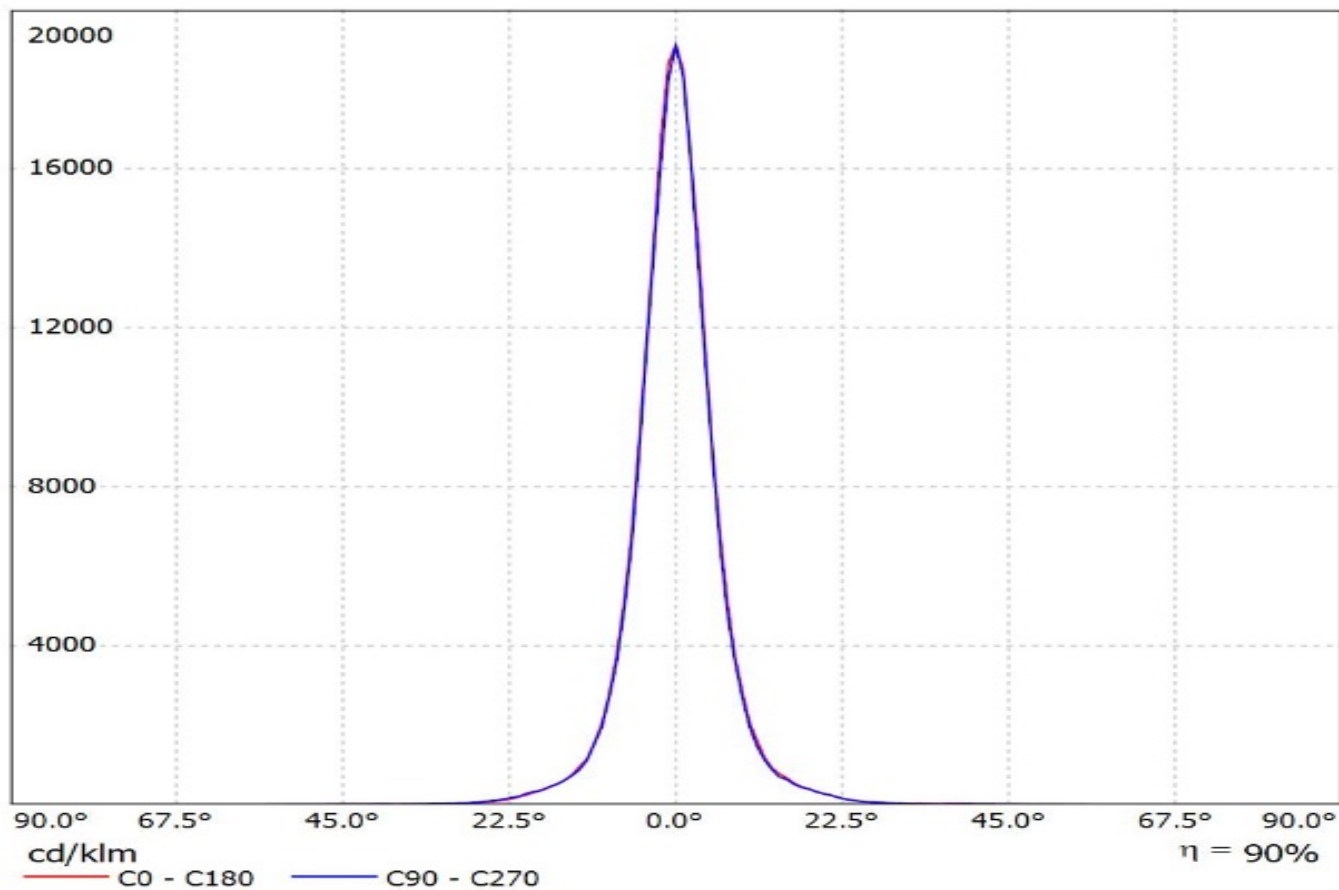

Luminaire: LEDiL Oy CA14507_G2-LXP2-D-P_(Z8Y22plus)

Lamps: 1 x Seoul_Z8Y22plus_(W6E2G)_125.652lm@250mA_P=0.69312W_I=0.250A

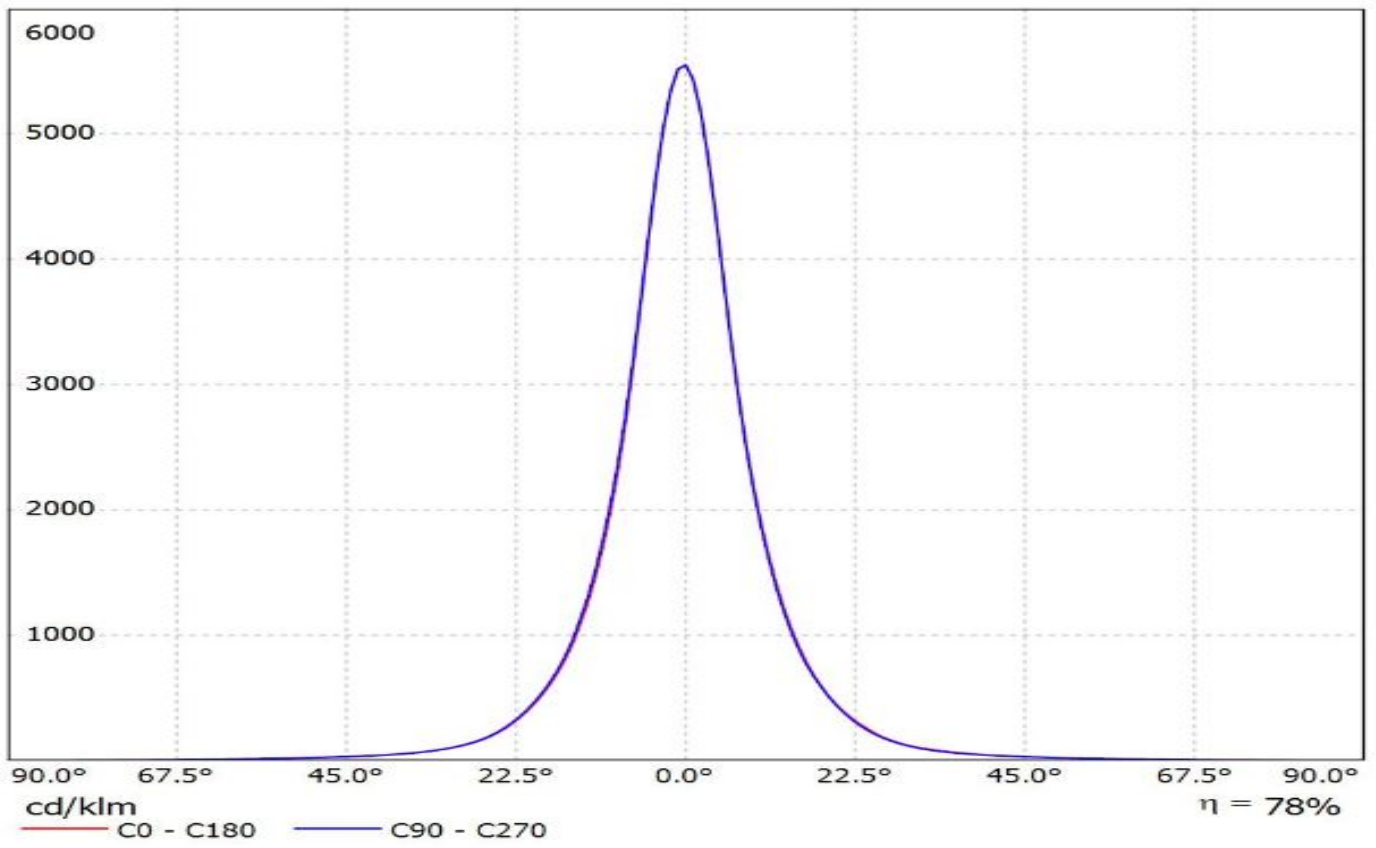

Luminaire: Ledil Oy CA14507_G2-LXP2-D-P_XP-G2_SIMULATED
Lamps: 1 x CREE XP-G2

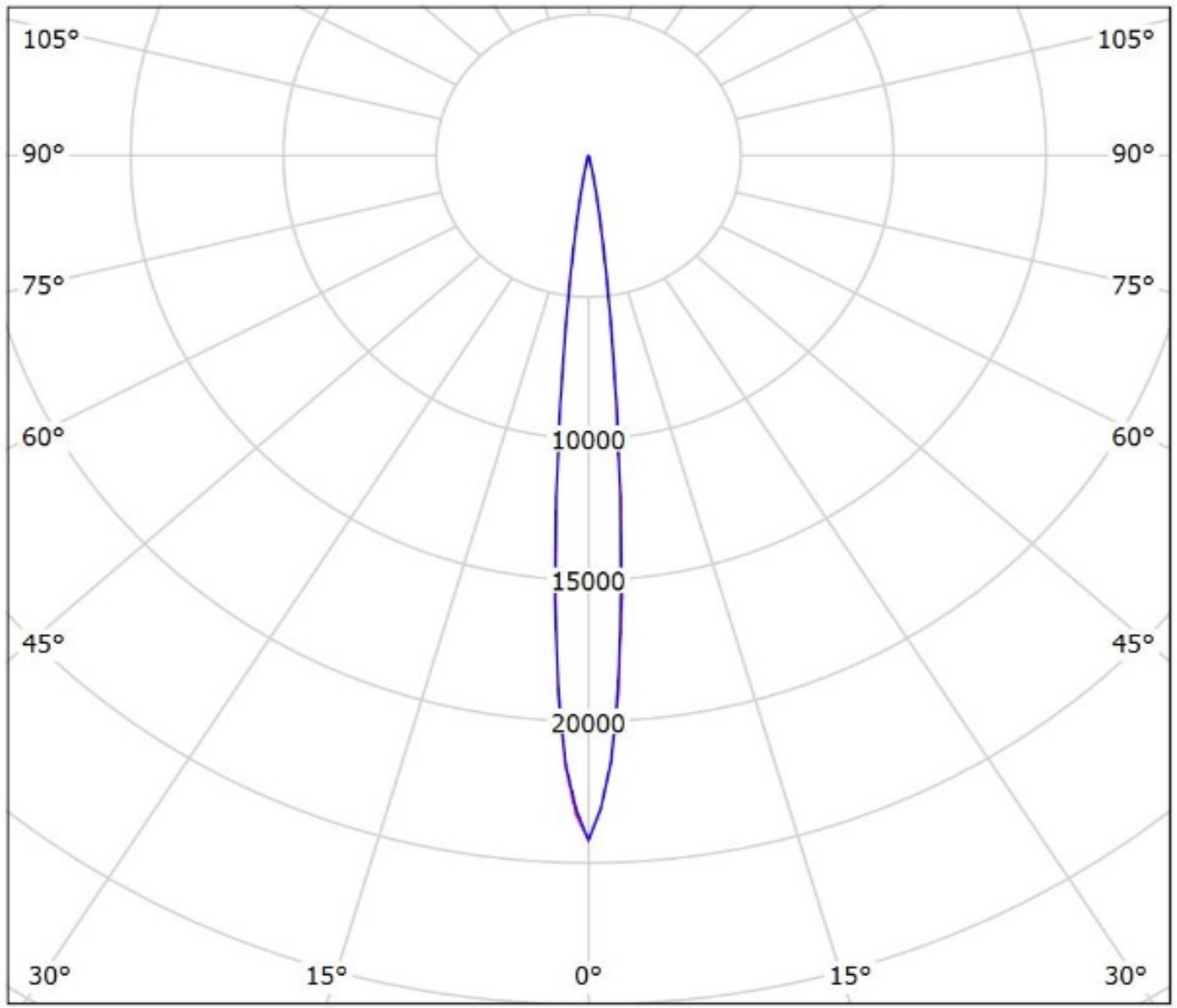

cd/klm
— C0 - C180 — C90 - C270

$\eta = 93\%$

Luminaire: Ledil Oy CA14507_G2-LXP2-D-P_(XT-E)_SIMULATED
Lamps: 1 x Cree XT-E

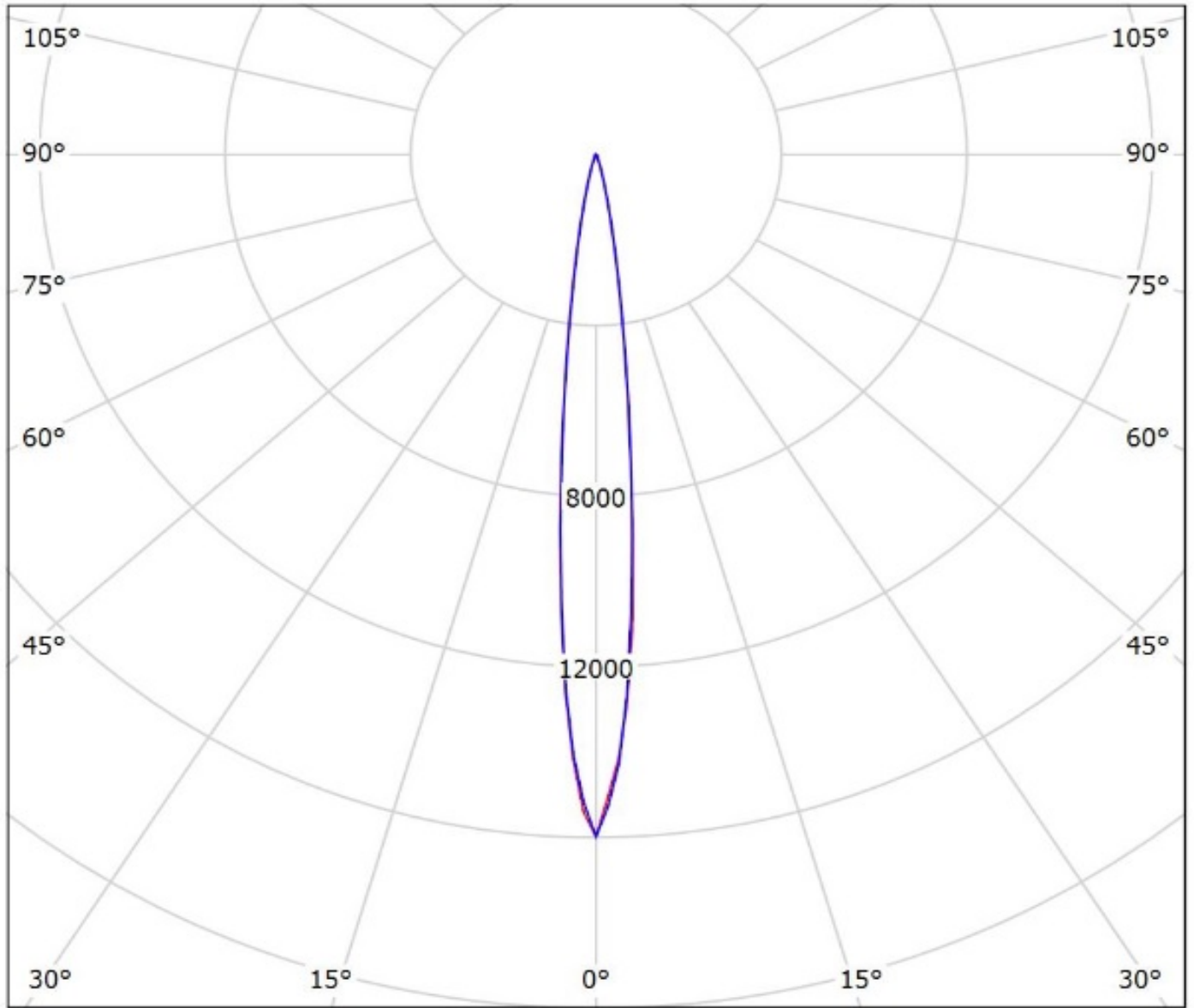

cd/klm
— C0 - C180 — C90 - C270

$\eta = 90\%$

Luminaire: Ledil Oy CA14507_G2-LXP2-D-P_(XP-G3)_SIMULATED

Lamps: 1 x Cree XP-G3

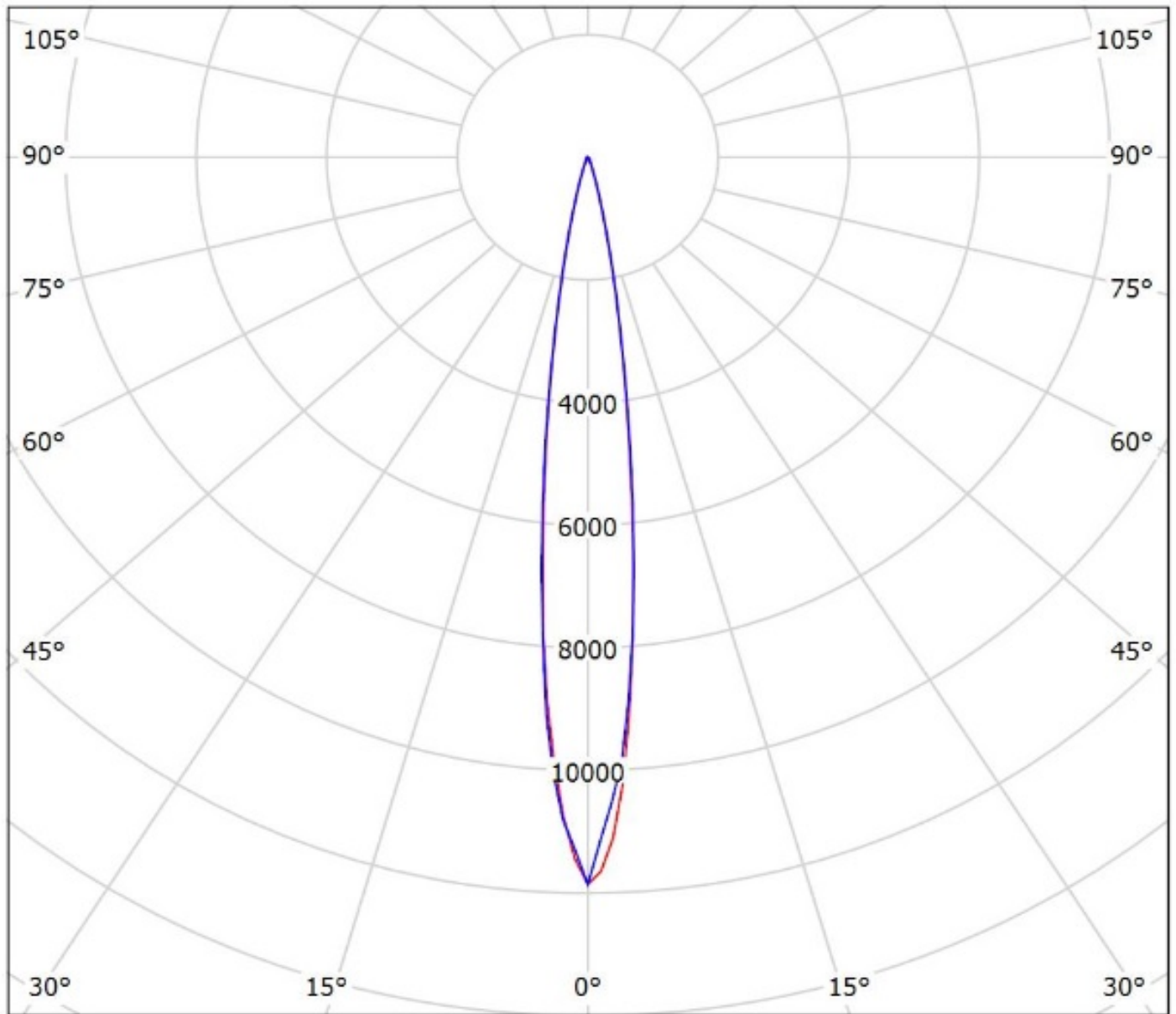

cd/klm

— C0 - C180 — C90 - C270

$\eta = 91\%$

Luminaire: LEDiL Oy CA14507_G2-LXP2-D-P_(XD16)

Lamps: 1 x Cree_XD16_(XD16AWT-H-2B0-S20-0B-002)_115.272lm@250mA_CCT=5700K_P=0.707833W_U=2.8336V

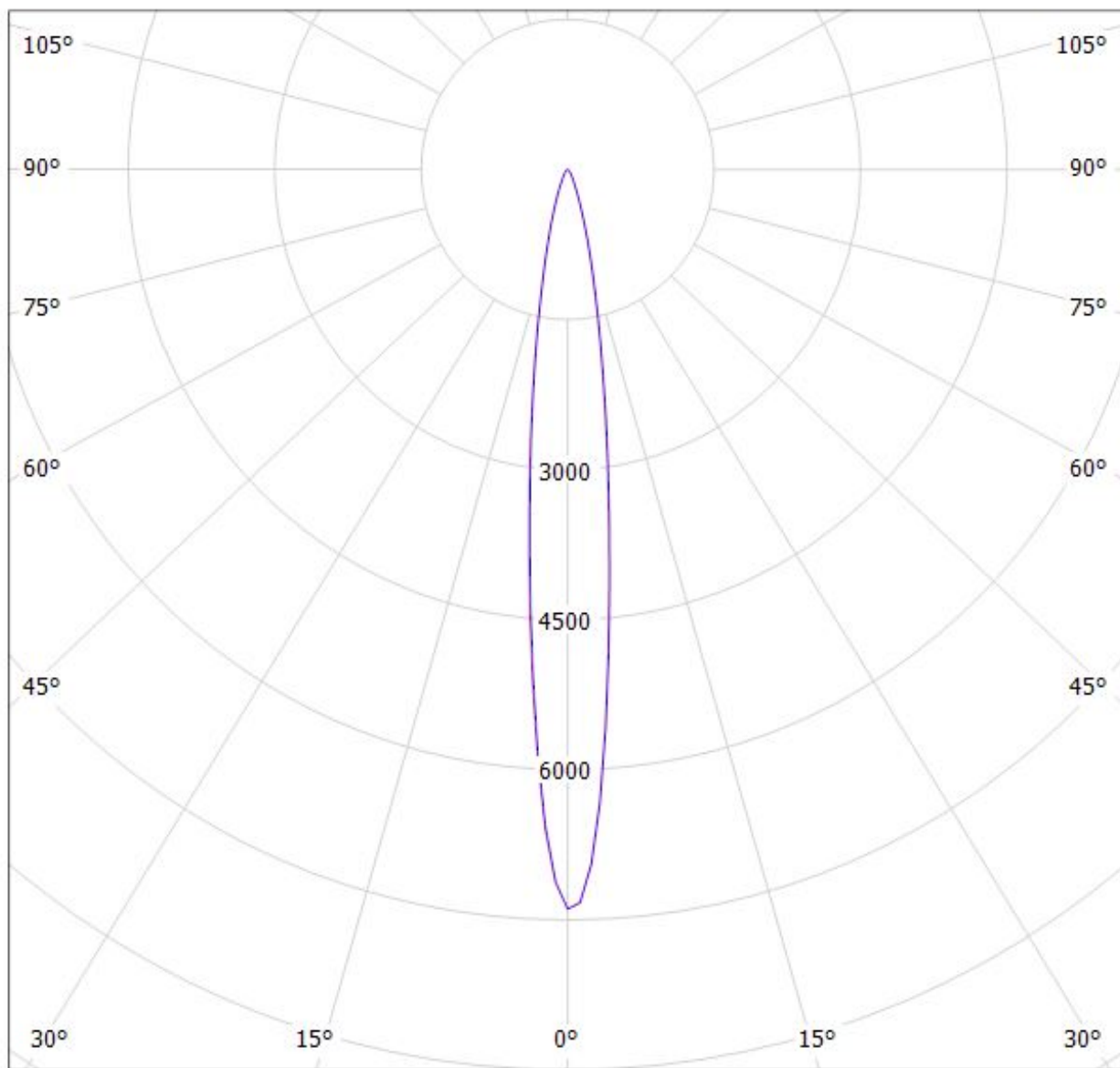

cd/klm

— C0 - C180

— C90 - C270

$\eta = 78\%$

Luminaire: Ledil Oy CA14507_G2-LXP2-D-P_(LG_H35C1)_SIMULATED
Lamps: 1 x LG H35C1

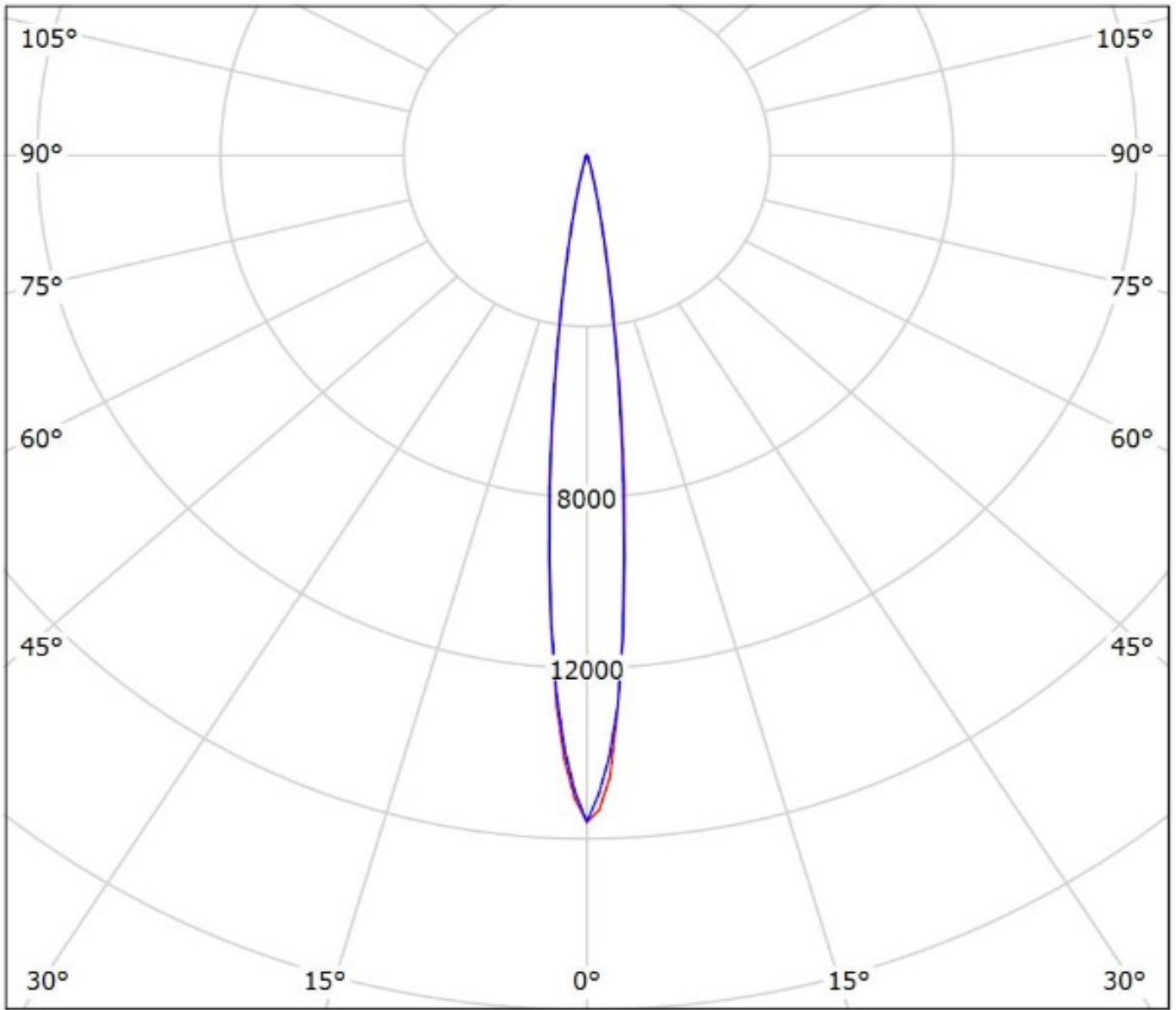

cd/klm

— C0 - C180 — C90 - C270

$\eta = 92\%$

Luminaire: LEDiL Oy
Lamps: 1 x CA14507_G2-LXP2-D-P_(LUXEON_Z-ES)

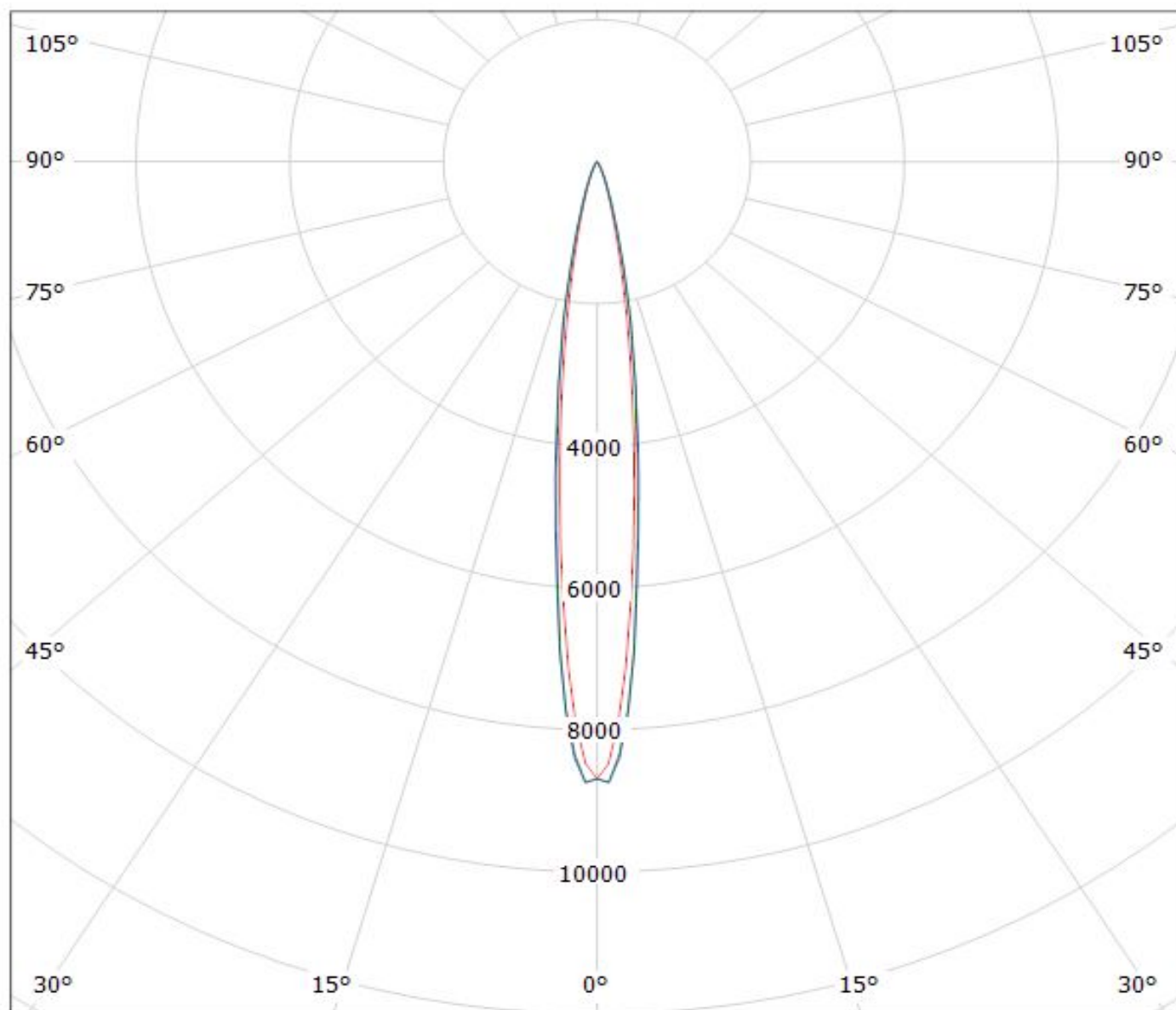

cd/klm

$\eta = 83\%$

— C0 - C180

— C90 - C270

— C76 - C256

Luminaire: Ledil Oy CA14507_G2-LXP2-D-P_(Luxeon_T)_SIMULATED
Lamps: 1 x Lumileds Luxeon T

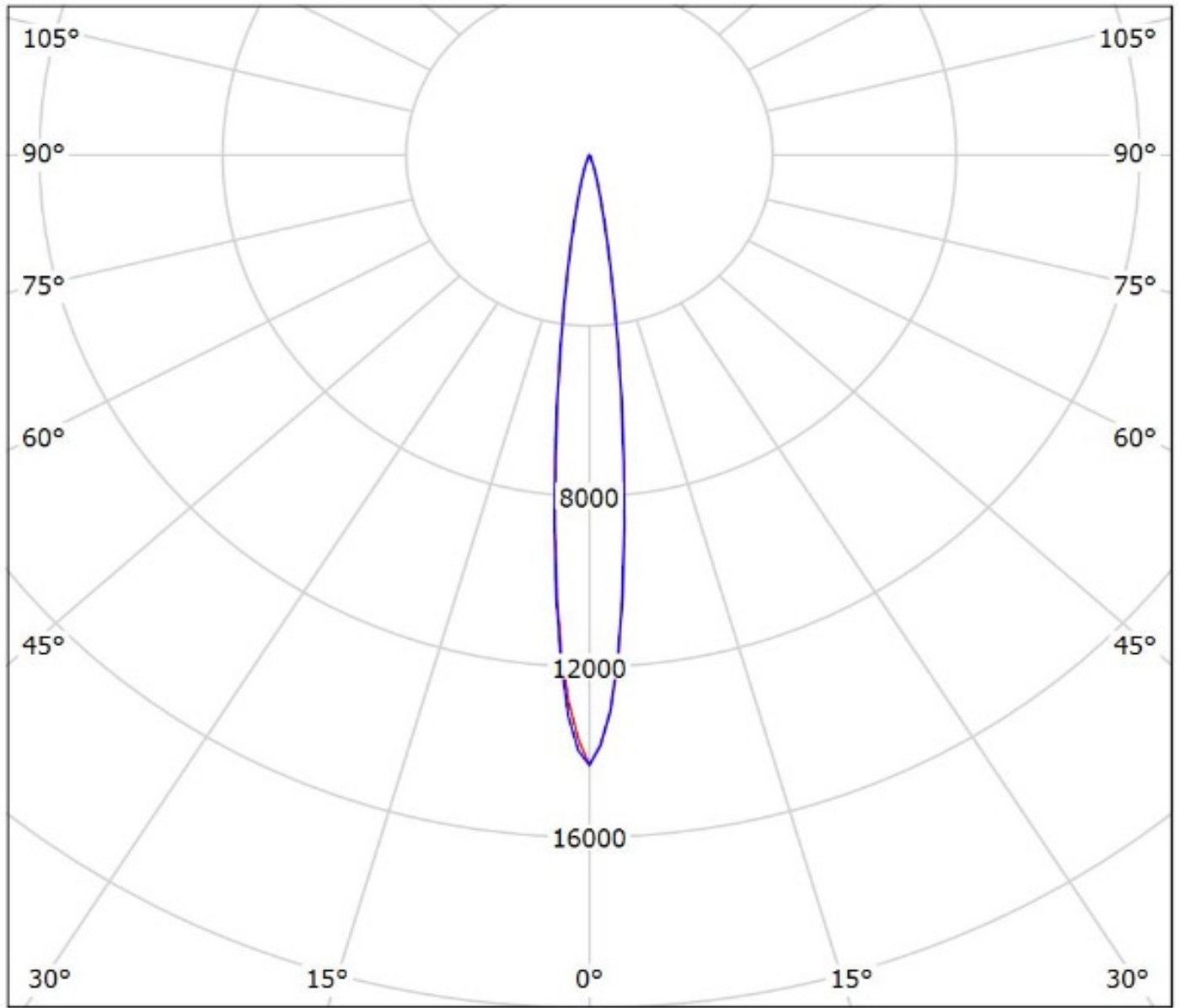

cd/klm

— C0 - C180 — C90 - C270

$\eta = 93\%$

Luminaire: Ledil Oy CA14507_G2-LXP2-D-P_(Luxeon_TX)_SIMULATED
Lamps: 1 x Lumileds Luxeon TX

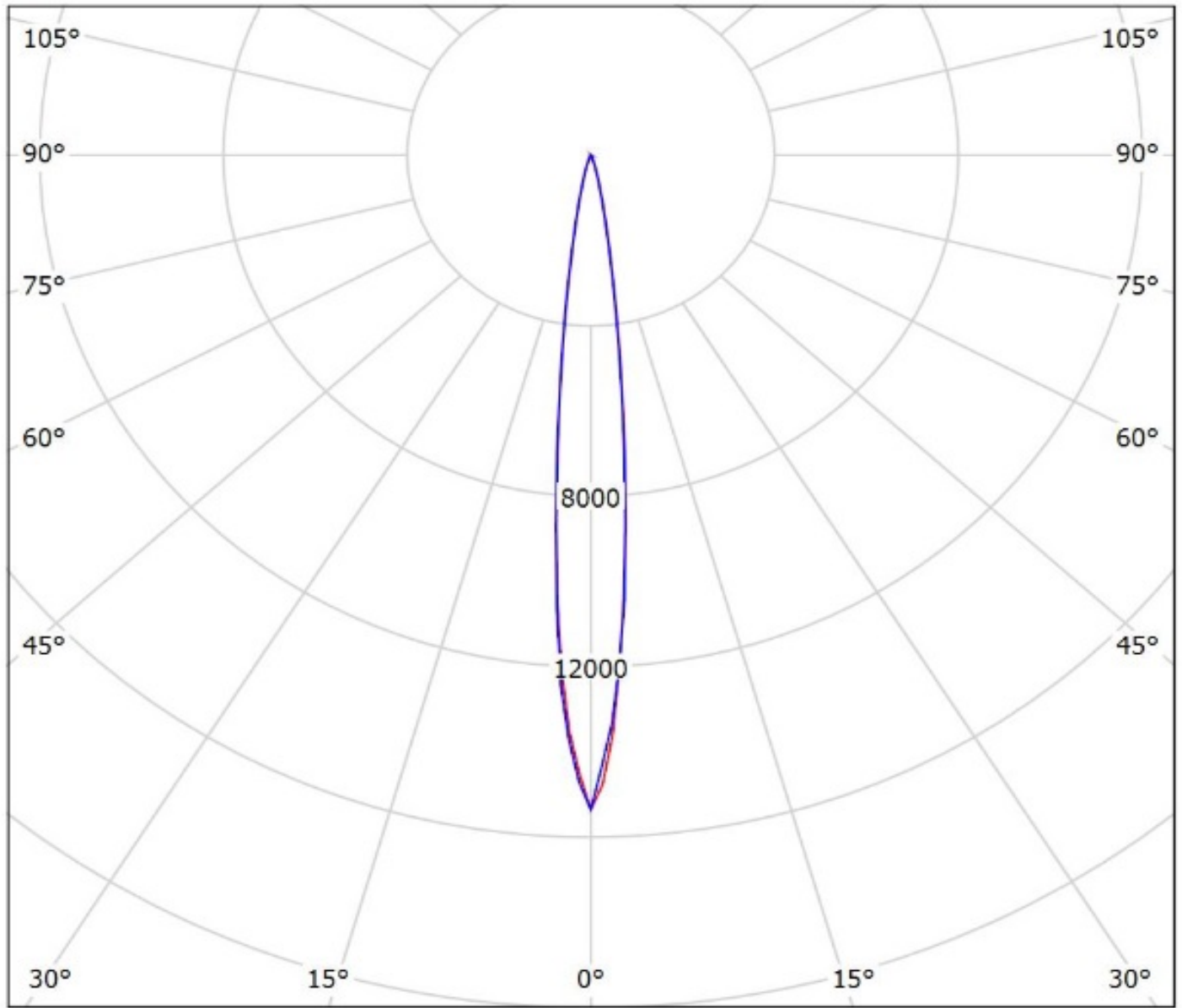

cd/klm

— C0 - C180 — C90 - C270

$\eta = 91\%$

Luminaire: Ledil CA14507_G2-LXP2-D-P_(LUXEON_C)

Lamps: 1 x LUXEON_C_white_85.7286lm@250mA_P=0.7463W_I=0.250A

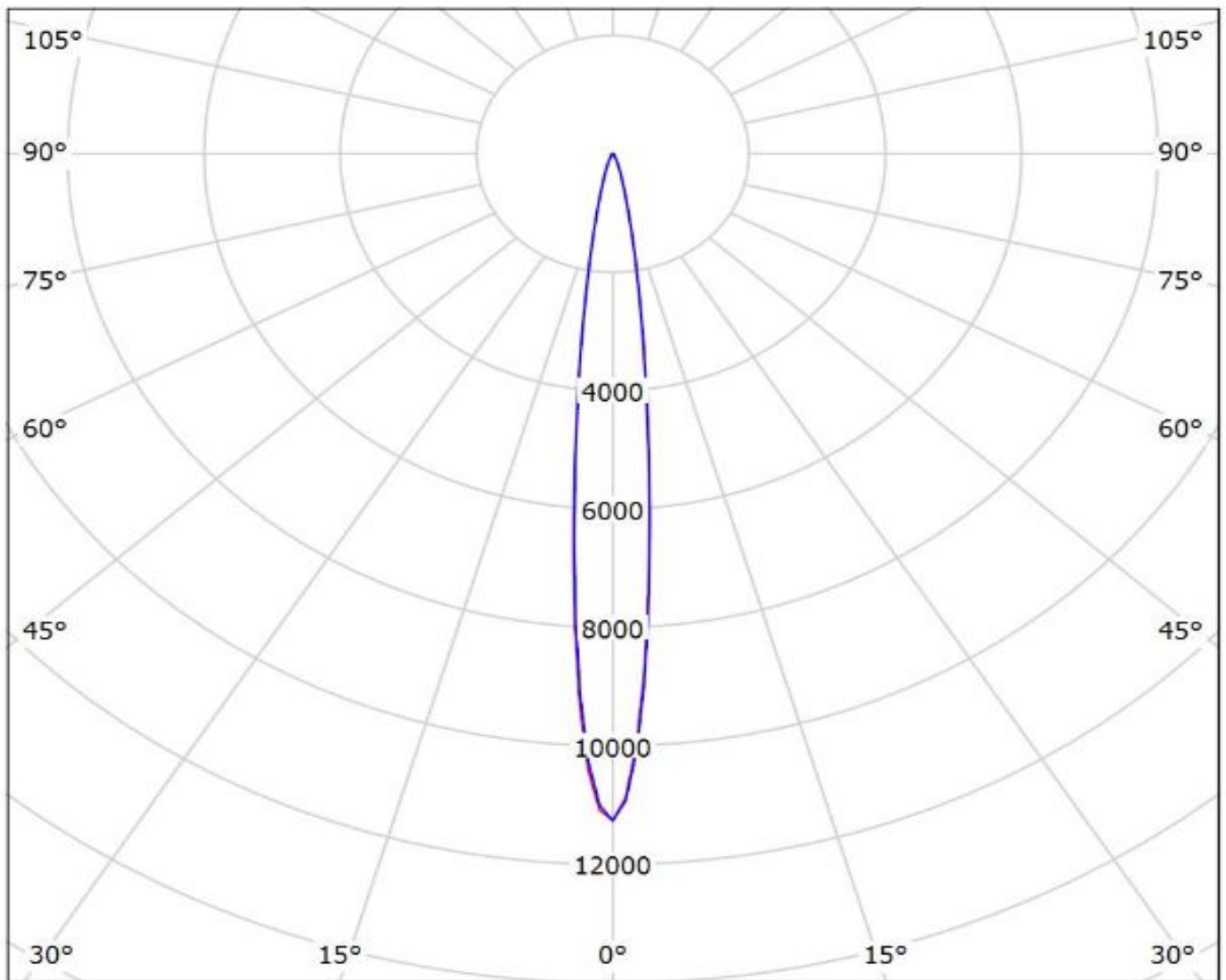

cd/klm

— C0 - C180 — C90 - C270

$\eta = 80\%$

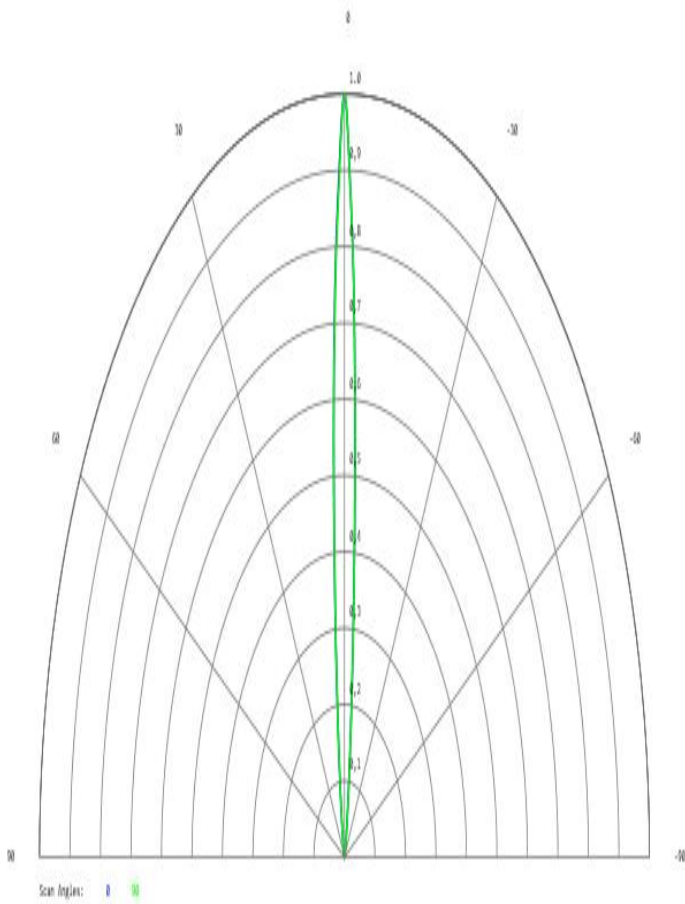

Detector Image: Radiant Intensity

16.5.2017
 Detector 5, NSCG Surface 1:
 Scan Angles: 0, 90
 Peak Intensity : 2,803E+01 Watts/Steradian

Zemax
 Zemax OpticStudio 15.5 SP2
 Luxeon IR compact.zmx
 Configuration 1 of 1

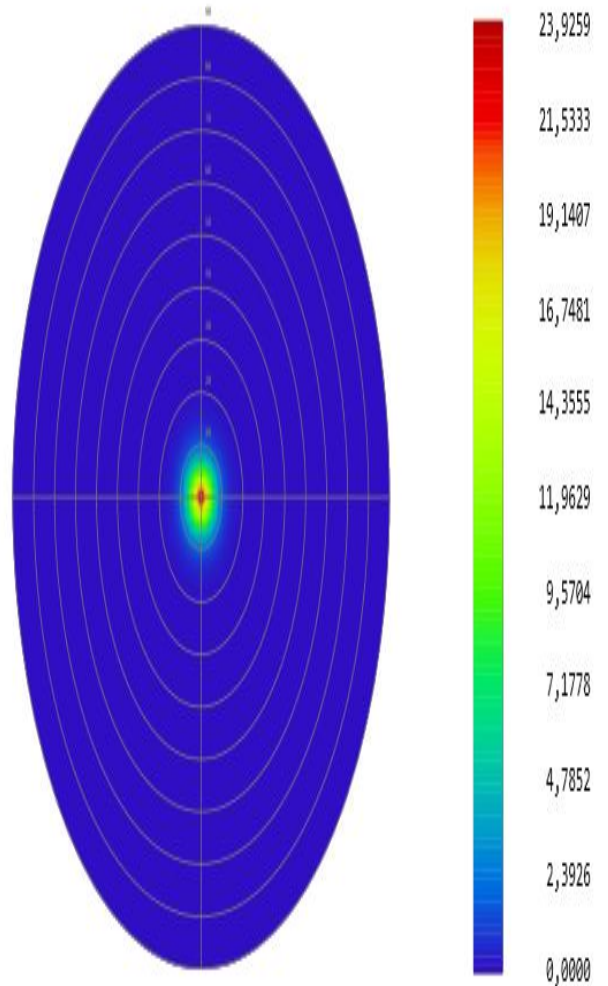

Detector Image: Radiant Intensity

16.5.2017
 Detector 5, NSCG Surface 1:
 Max polar angle: 90,00 deg, Total Hits = 2307934
 Peak Intensity : 2,393E+01 Watts/Steradian
 Total Power : 8,414E-01 Watts

Zemax
 Zemax OpticStudio 15.5 SP2
 Luxeon IR compact.zmx
 Configuration 1 of 1

Luminaire: LEDiL Oy CA14507_G2-LXP2-D-P_(Luxeon_V)

Lamps: 1 x Lumileds_Luxeon_V_122.923lm@250mA_CCT=4000K_P=0.704836W_I=0.25A

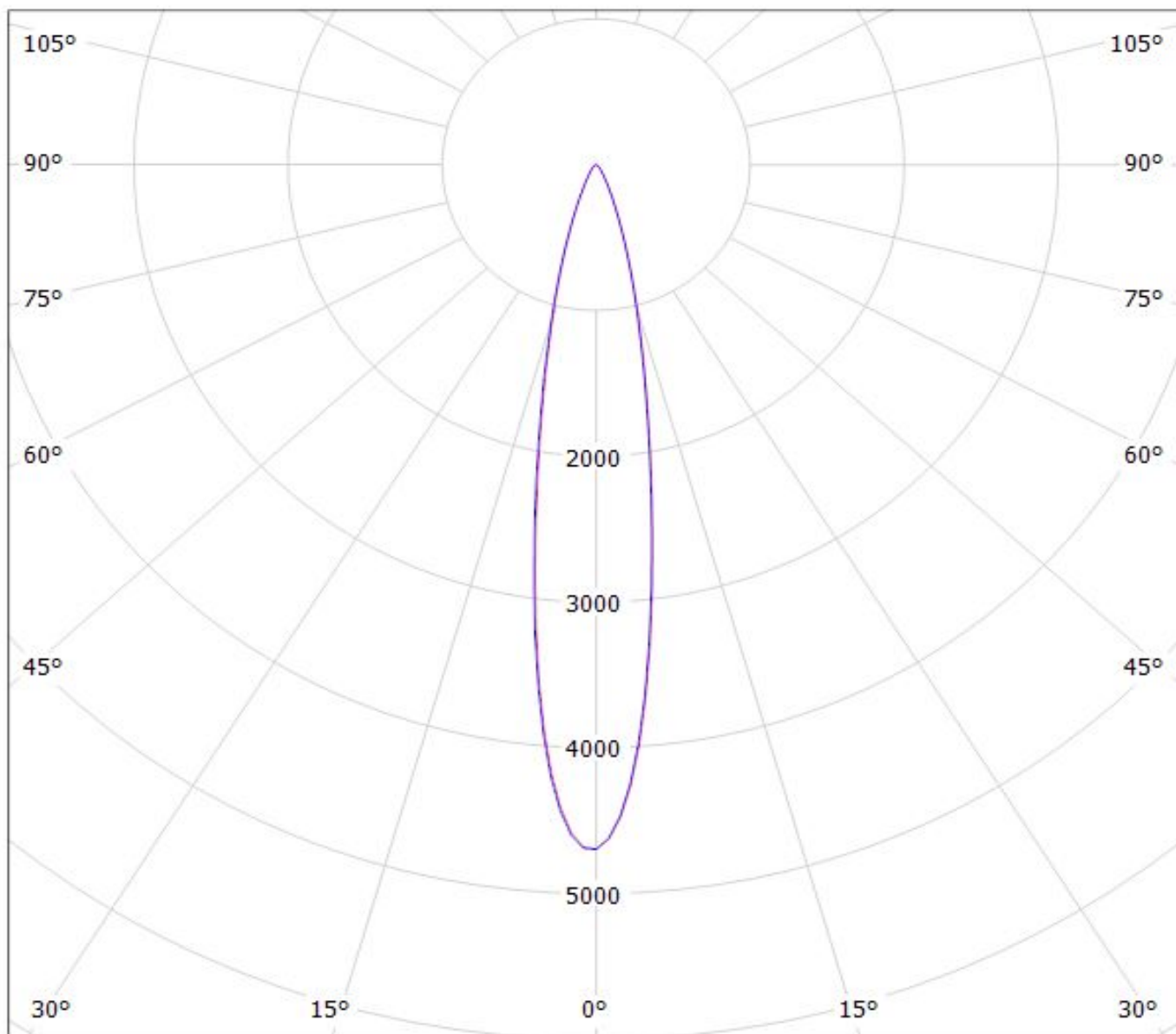

cd/klm

$\eta = 83\%$

— C0 - C180

— C90 - C270

Luminaire: LEDiL Oy CA14507_G2-LXP2-D-P_(Nichia_NCSxx19A)

Lamps: 1 x Nichia_NCSxx19A_66.5093lm@250mA_P=0.78701W_I=0.2499A

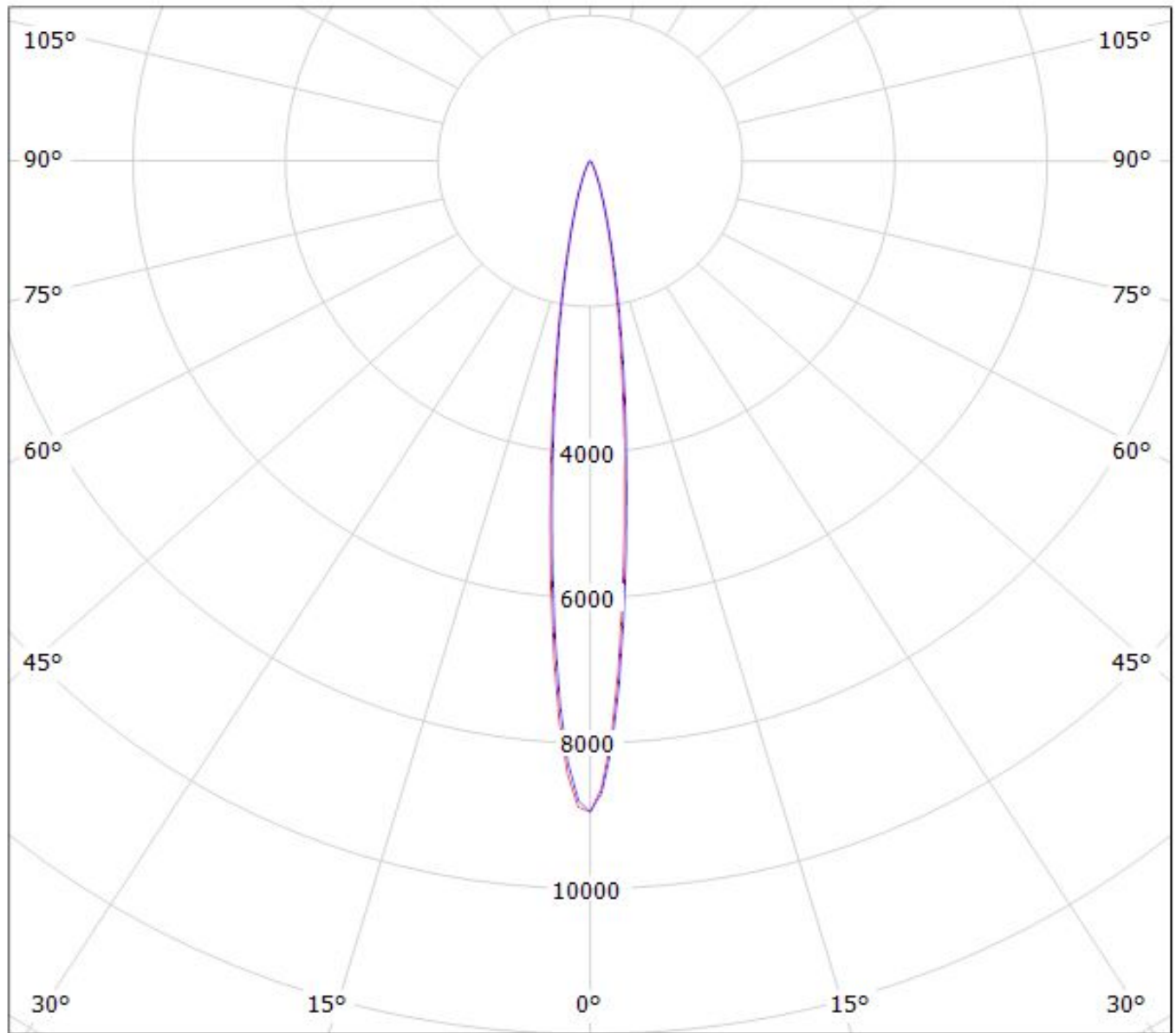

cd/klm

— C0 - C180

— C90 - C270

$\eta = 86\%$

Luminaire: LEDiL Oy CA14507_G2-LXP2-D_(NWSL229AE)

Lamps: 1 x Nichia_NWSL229AE_120.54lm@250mA_P=0.7128W_I=0.250A

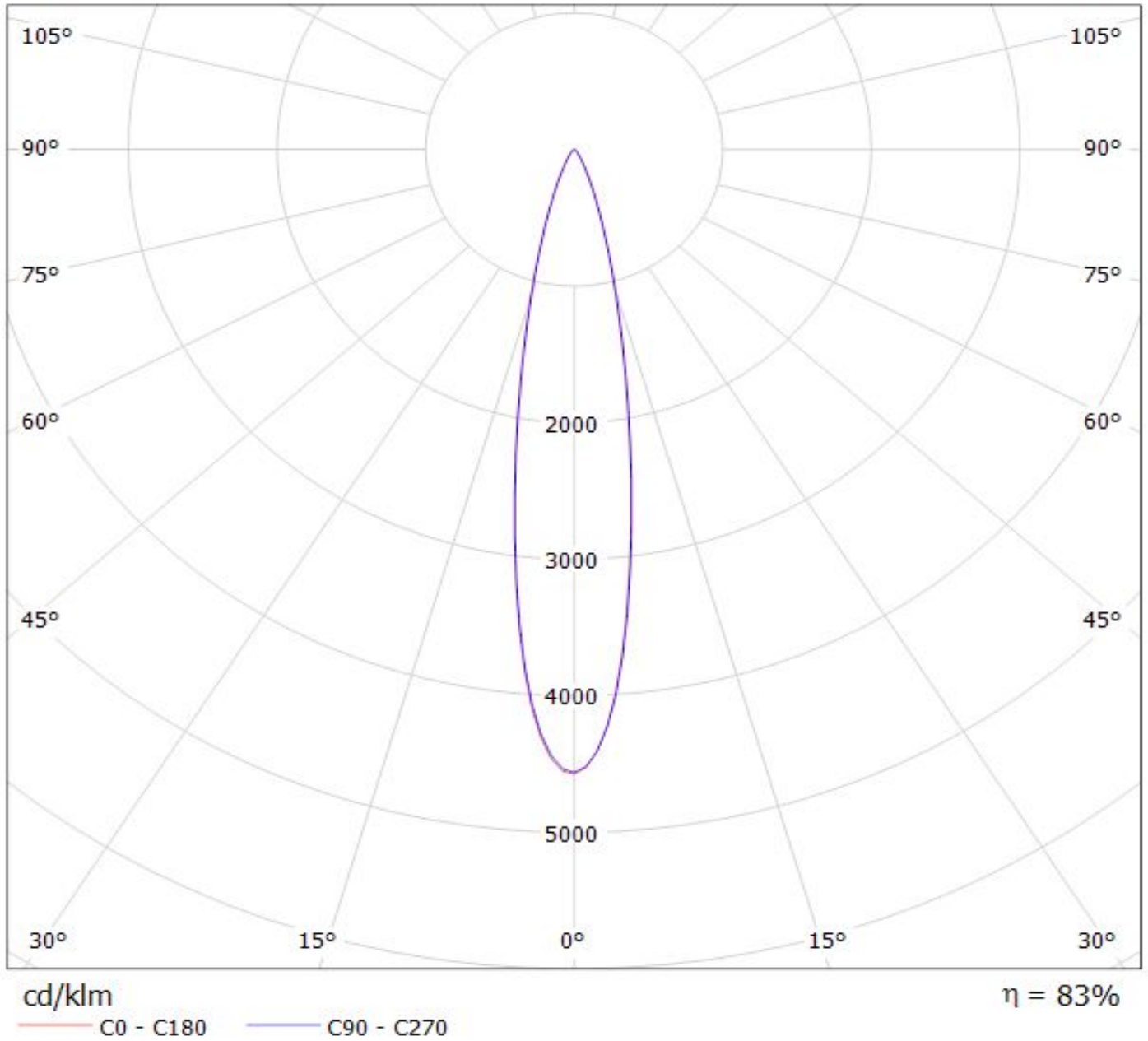

Luminaire: Ledil Oy CA14507_G2-LXP2-D-P_(NVSxx19B)_SIMULATED
Lamps: 1 x Nichia NVSxx19V (NVSW219B)

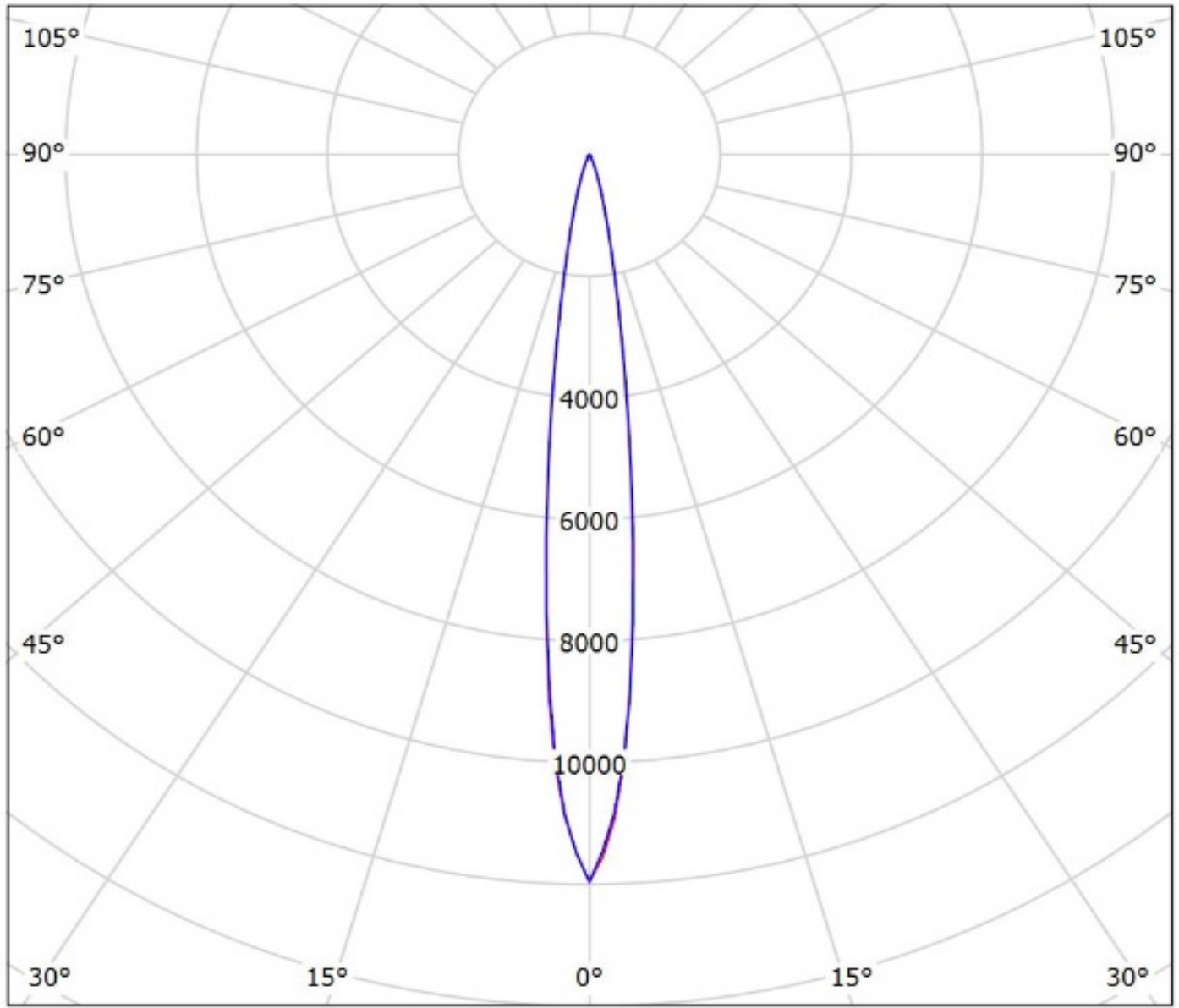

cd/klm
— C0 - C180 — C90 - C270

$\eta = 89\%$

Luminaire: LEDiL Oy CA14507_G2-LXP2-D-P_(NVSW3x9A)

Lamps: 1 x Nichia_NVSW3x9A_(sm405/R70)_122.334lm@250mA_P=0.705435W_I=0.250A

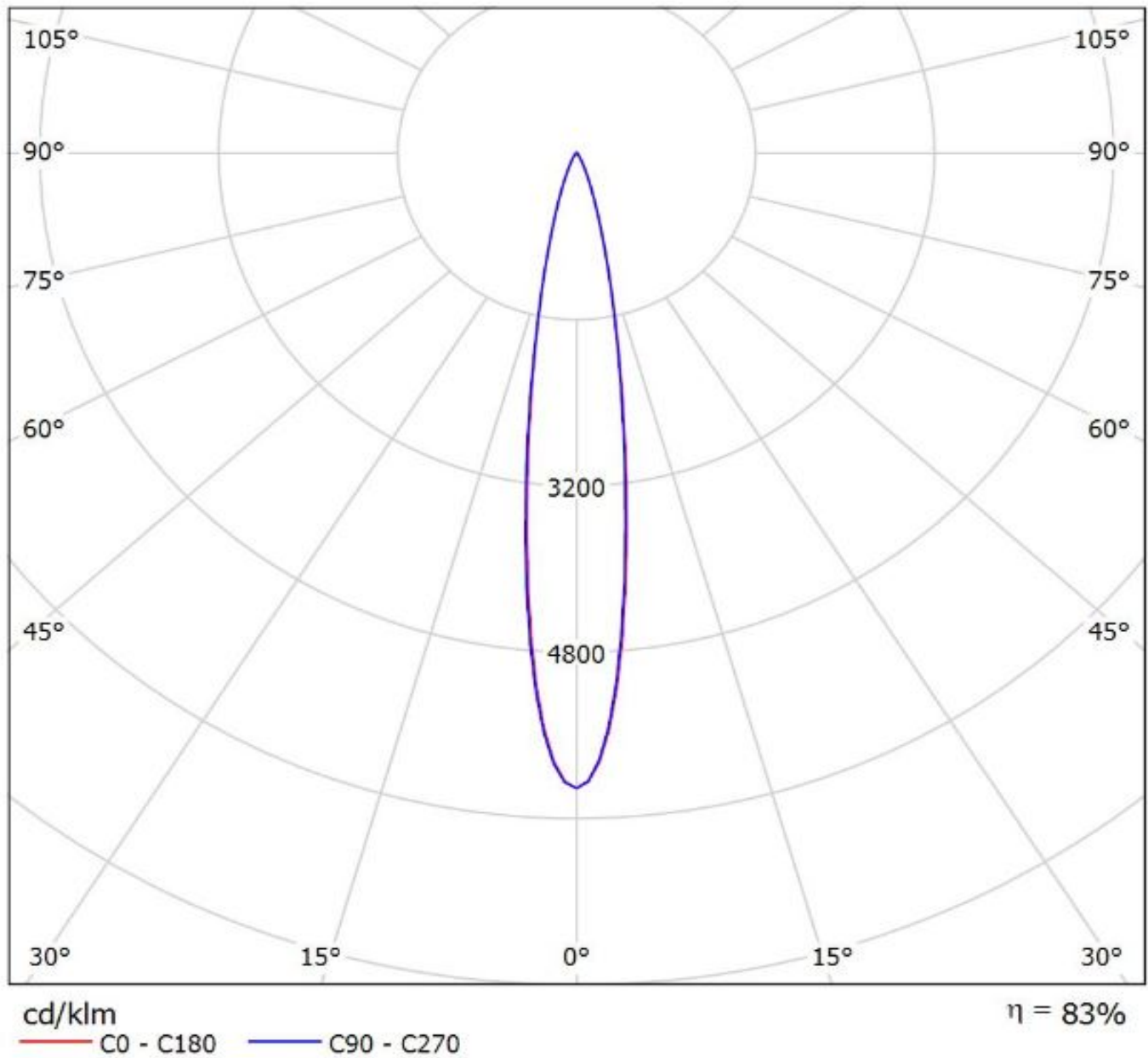

Luminaire: Ledil Oy CA14507_G2-LXP2-D-P_(Oslon_Square_Gen3)_SIMULATED
Lamps: 1 x Osram Oslon Square Gen 3 (GW_CSSRM2.PC)

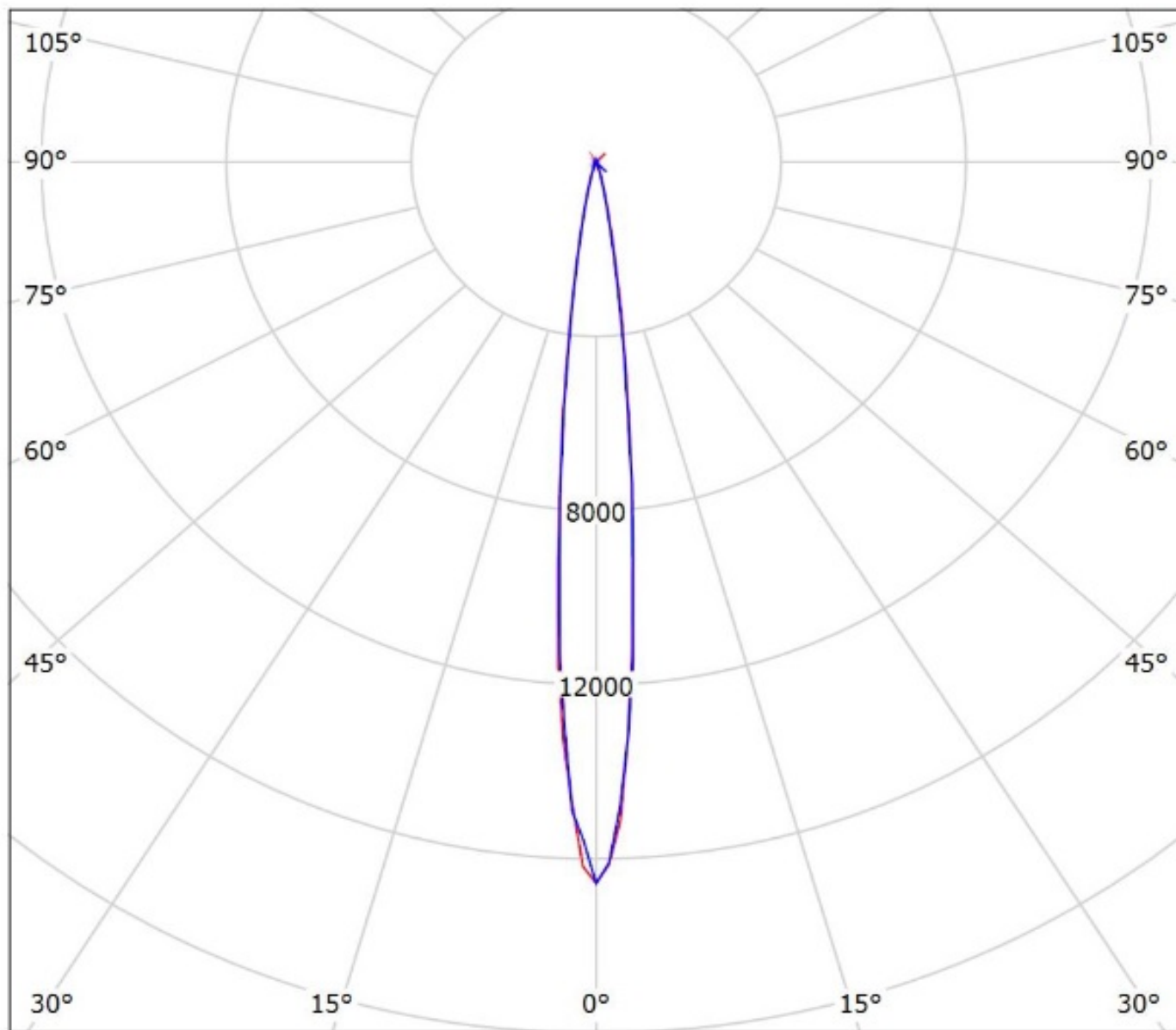

cd/klm

— C0 - C180 — C90 - C270

$\eta = 92\%$

Luminaire: Ledil Oy CA14507_G2-LXP2-D-P_(Oslon_SSL_80)_SIMULATED
Lamps: 1 x Osram Oslon SSL 80 (LA CP7P)

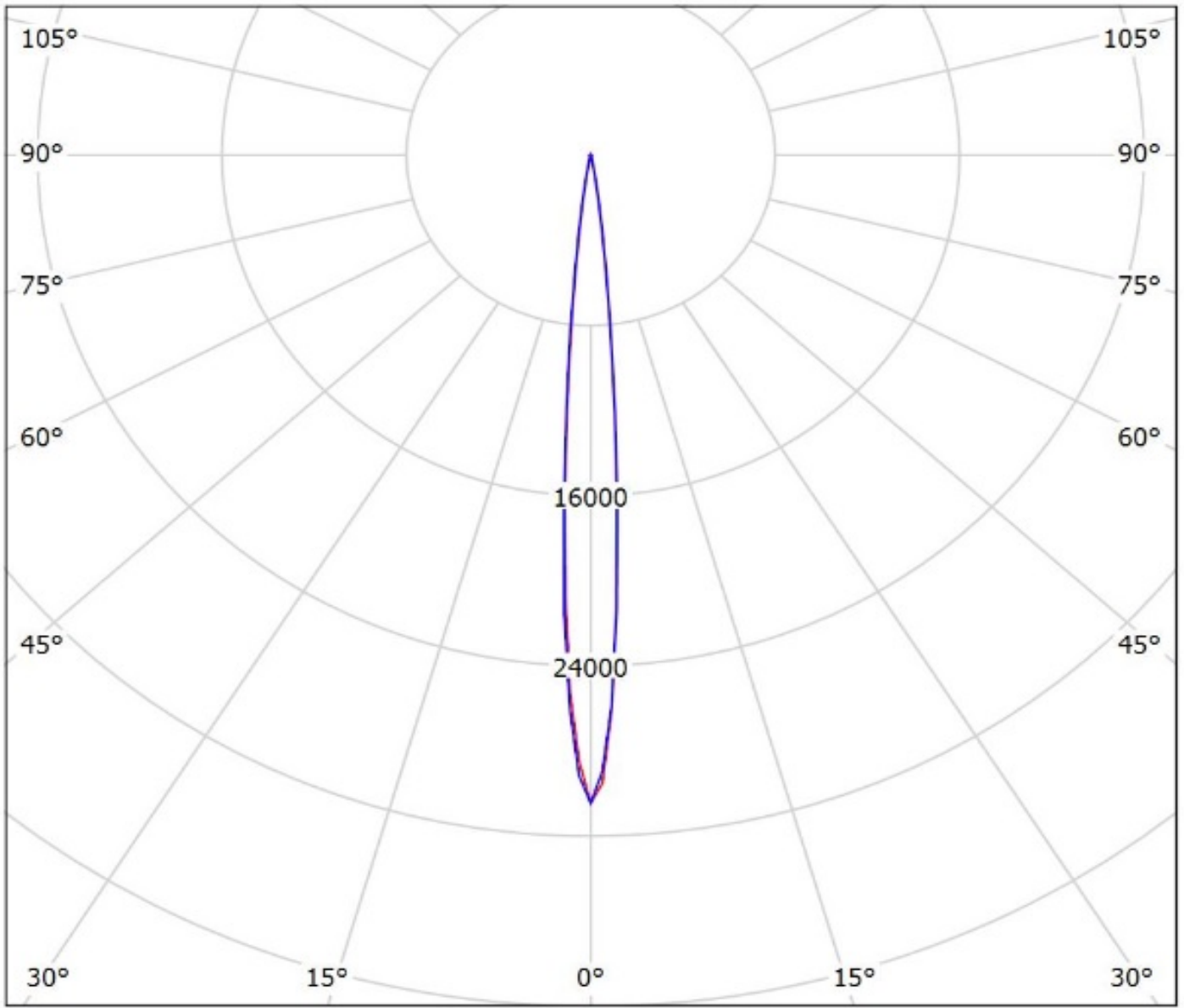

cd/klm
— C0 - C180 — C90 - C270

$\eta = 92\%$

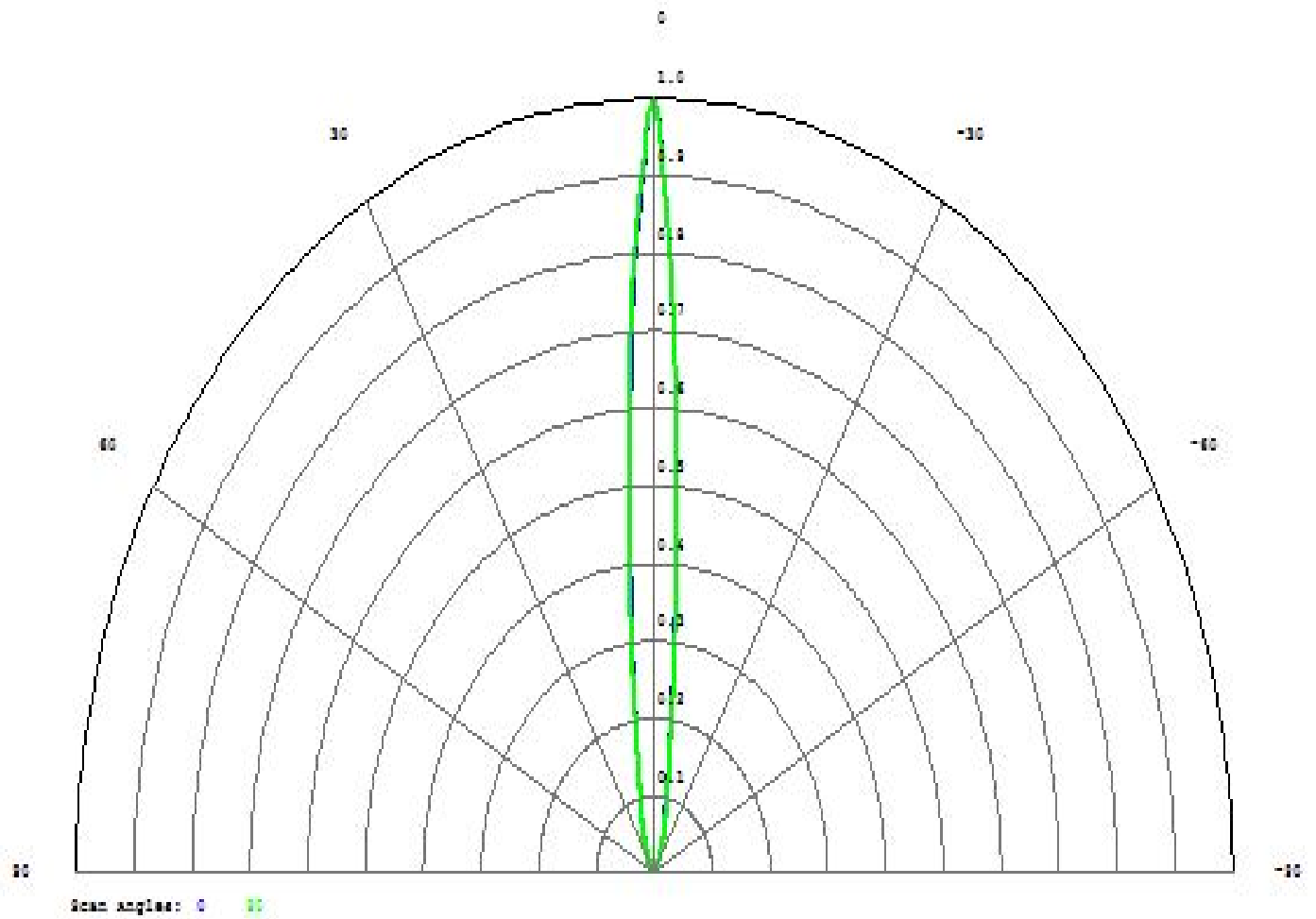

Detector Image: Radiant Intensity

8.4.2016
 Detector 4, NSCG Surface 1:
 Scan Angles: 0, 90
 Peak Intensity : 1.131E+001 Watts/Steradian

CA14507_G2-LXP2-D-P_SFH_4770S.ZMX
 Configuration 1 of 1

Luminaire: Ledil Oy CA14507_G2-LXP2-D-P_(OSRAM_OSLON_SQUARE_FLAT)_SIMULATED
Lamps: 1 x OSRAM_OSLON_SQUARE_FLAT

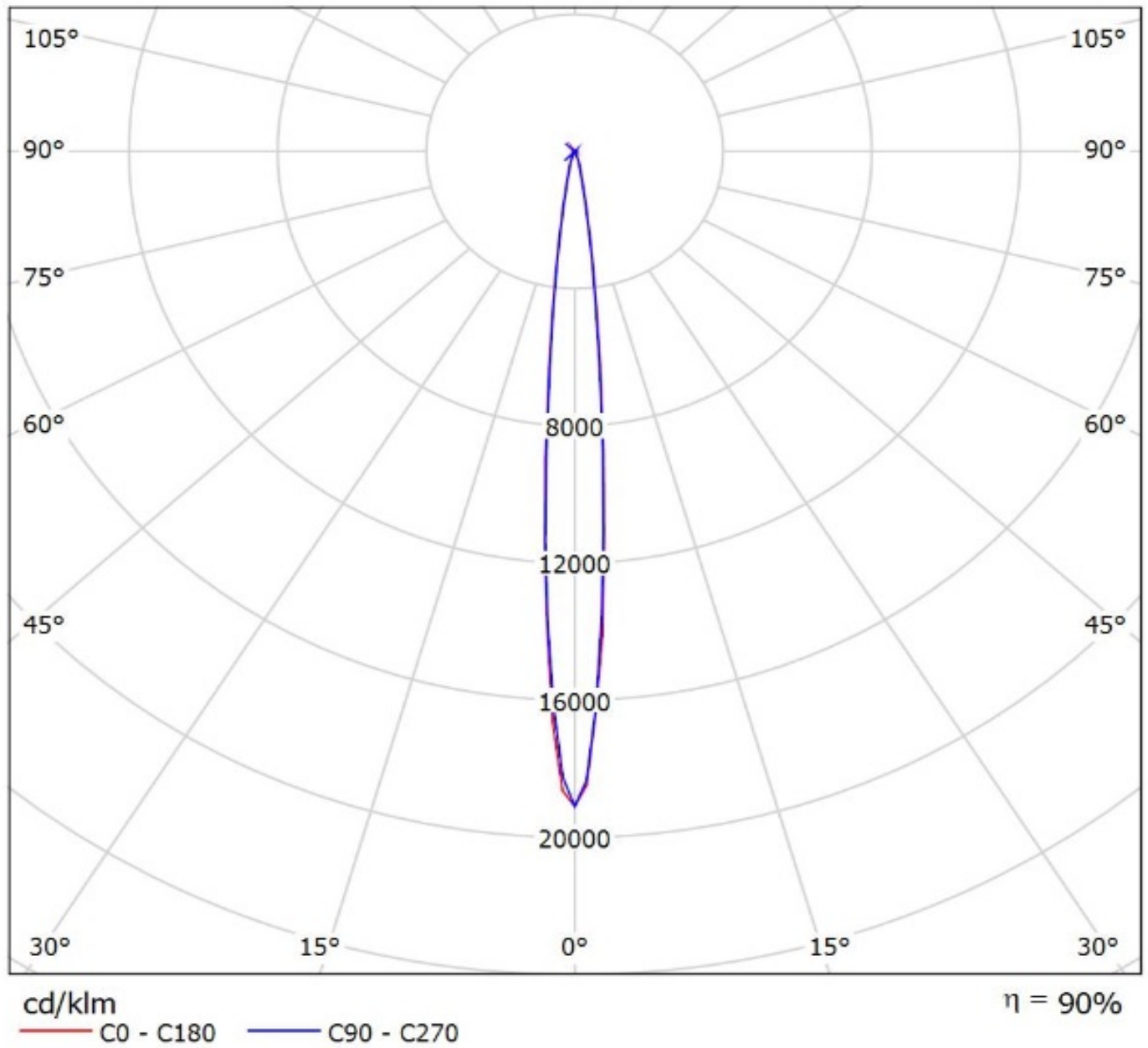

Luminaire: LEDiL Oy CA14507_G2-LXP2-D-P_(Z8Y22plus)

Lamps: 1 x Seoul_Z8Y22plus_(W6E2G)_125.652lm@250mA_P=0.69312W_I=0.250A

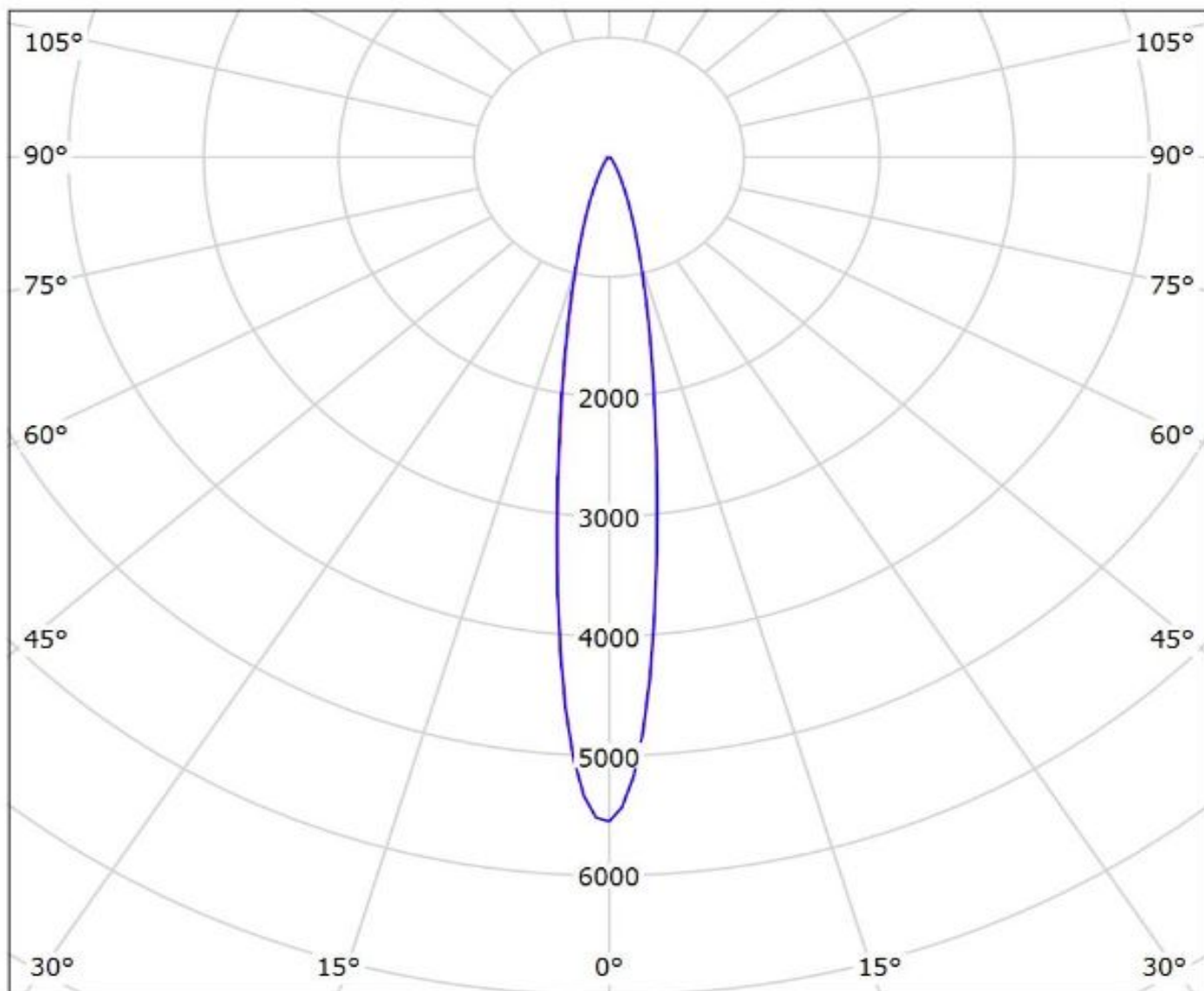

cd/klm

— C0 - C180 — C90 - C270

η = 78%

NOTE: The typical divergence will be changed by different color, chip size and chip position tolerance. The typical total divergence is the full angle measured where the luminous intensity is half of the peak value.