



Dual N-Channel 20-V (D-S) MOSFET, Common Drain

PRODUCT SUMMARY		
V _{DS} (V)	r _{DS(on)} (Ω)	I _D (A)
20	0.026 @ V _{GS} = 4.5 V	6.5
	0.031 @ V _{GS} = 2.5 V	5.8
	0.039 @ V _{GS} = 1.8 V	5.0



ESD Protected
3000 V

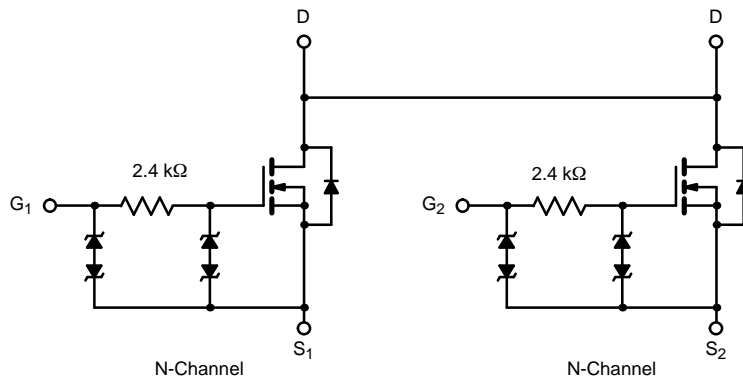
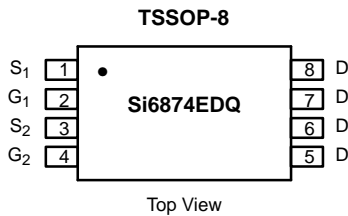

ABSOLUTE MAXIMUM RATINGS (T _A = 25 °C UNLESS OTHERWISE NOTED)					
Parameter		Symbol	10 secs	Steady State	Unit
Drain-Source Voltage		V _{DS}	20		V
Gate-Source Voltage		V _{GS}	± 12		
Continuous Drain Current (T _J = 150 °C) ^a	T _A = 25 °C	I _D	6.5	5.3	A
	T _A = 85 °C		4.7	4.2	
Pulsed Drain Current		I _{DM}	30		
Continuous Source Current (Diode Conduction) ^a		I _S	1.50	1.10	W
Maximum Power Dissipation ^a	T _A = 25 °C	P _D	1.67	1.20	
	T _A = 85 °C		1.06	0.76	
Operating Junction and Storage Temperature Range		T _J , T _{stg}	-55 to 150		°C

THERMAL RESISTANCE RATINGS					
Parameter		Symbol	Typical	Maximum	Unit
Maximum Junction-to-Ambient ^a	t ≤ 10 sec	R _{thJA}	60	75	°C/W
	Steady State		86	105	
Maximum Junction-to-Foot (Drain)	Steady State	R _{thJF}	38	45	

Notes

a. Surface Mounted on 1" x 1" FR4 Board.



SPECIFICATIONS (T_J = 25 °C UNLESS OTHERWISE NOTED)

Parameter	Symbol	Test Condition	Min	Typ	Max	Unit
Static						
Gate Threshold Voltage	V _{GS(th)}	V _{DS} = V _{GS} , I _D = 250 μA	0.40			V
Gate-Body Leakage	I _{GSS}	V _{DS} = 0 V, V _{GS} = ±4.5 V			±1	μA
		V _{DS} = 0 V, V _{GS} = ±12 V			±10	mA
Zero Gate Voltage Drain Current	I _{DSS}	V _{DS} = 16 V, V _{GS} = 0 V			1	μA
		V _{DS} = 16 V, V _{GS} = 0 V, T _J = 85 °C			20	
On-State Drain Current ^a	I _{D(on)}	V _{DS} = 5 V, V _{GS} = 4.5 V	20			A
Drain-Source On-State Resistance ^a	r _{DS(on)}	V _{GS} = 4.5 V, I _D = 6.5 A		0.021	0.026	Ω
		V _{GS} = 2.5 V, I _D = 5.8 A		0.025	0.031	
		V _{GS} = 1.8 V, I _D = 5.0 A		0.031	0.039	
Forward Transconductance ^a	g _{fs}	V _{DS} = 10 V, I _D = 6.5 A		25		S
Diode Forward Voltage ^a	V _{SD}	I _S = 1.5 A, V _{GS} = 0 V		0.65	1.1	V
Dynamic^b						
Total Gate Charge	Q _g	V _{DS} = 10 V, V _{GS} = 4.5 V, I _D = 6.5 A		12.5	18	nC
Gate-Source Charge	Q _{gs}			2.7		
Gate-Drain Charge	Q _{gd}			2.7		
Turn-On Delay Time	t _{d(on)}	V _{DD} = 10 V, R _L = 10 Ω I _D ≅ 1 A, V _{GEN} = 4.5 V, R _G = 6 Ω		0.7	1.0	μs
Rise Time	t _r			1.3	2.0	
Turn-Off Delay Time	t _{d(off)}			5.5	8.0	
Fall Time	t _f			4.6	7.0	

Notes

- a. Pulse test; pulse width ≤ 300 μs, duty cycle ≤ 2%.
- b. Guaranteed by design, not subject to production testing.

TYPICAL CHARACTERISTICS (25 °C UNLESS NOTED)

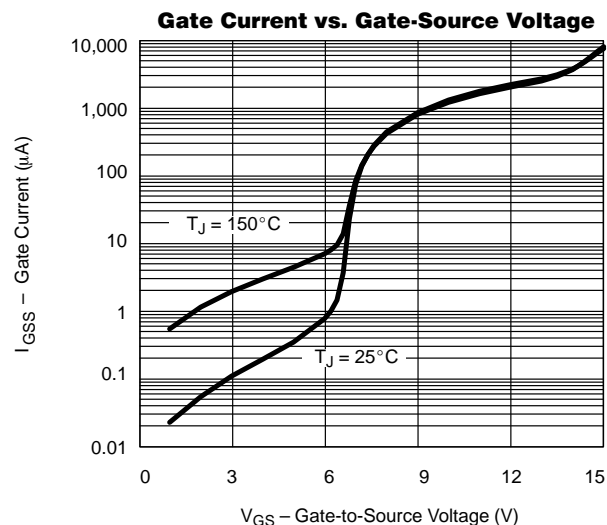
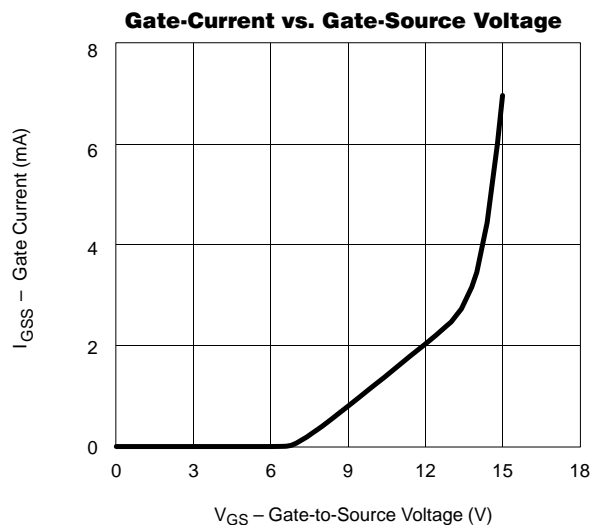



TYPICAL CHARACTERISTICS (25°C UNLESS NOTED)

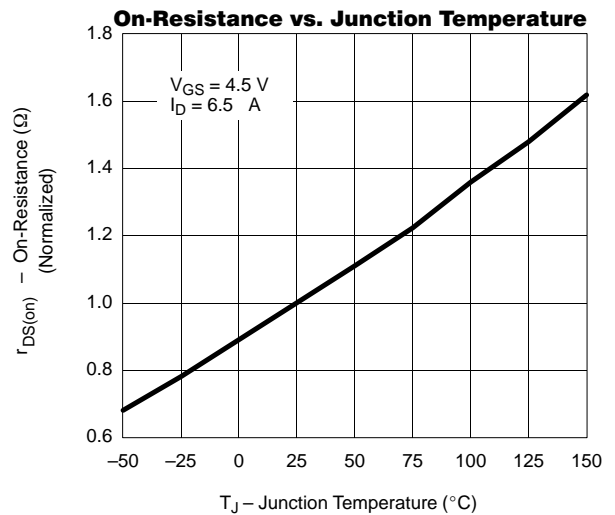
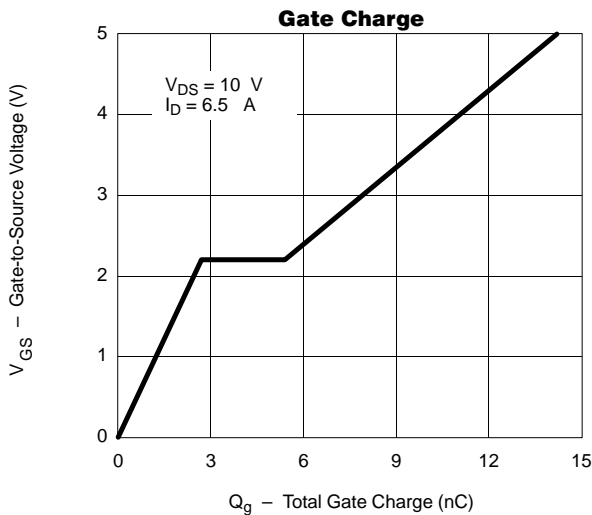
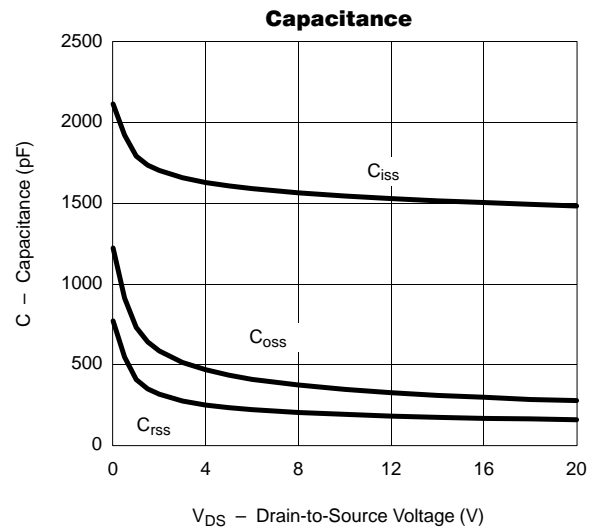
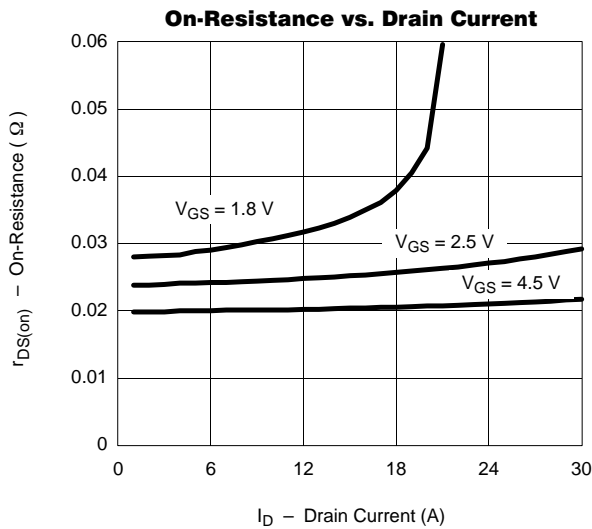
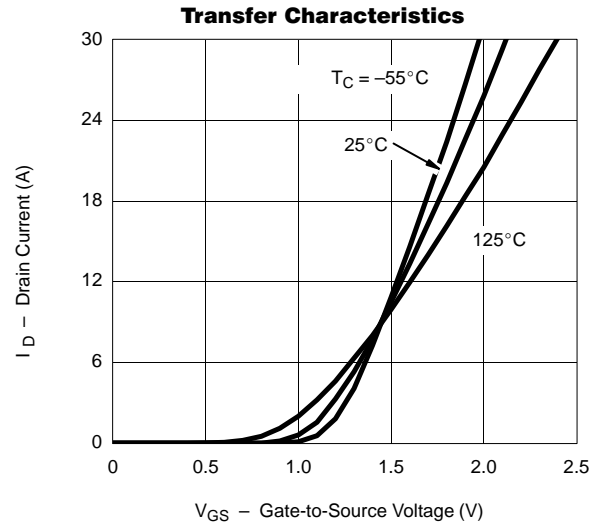
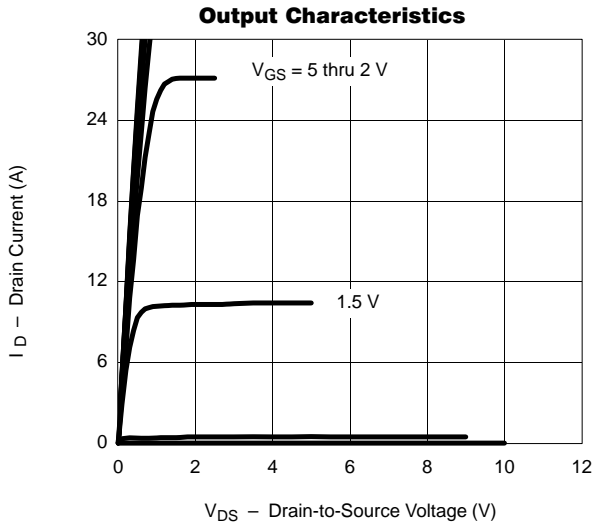



TYPICAL CHARACTERISTICS (25°C UNLESS NOTED)

Source-Drain Diode Forward Voltage

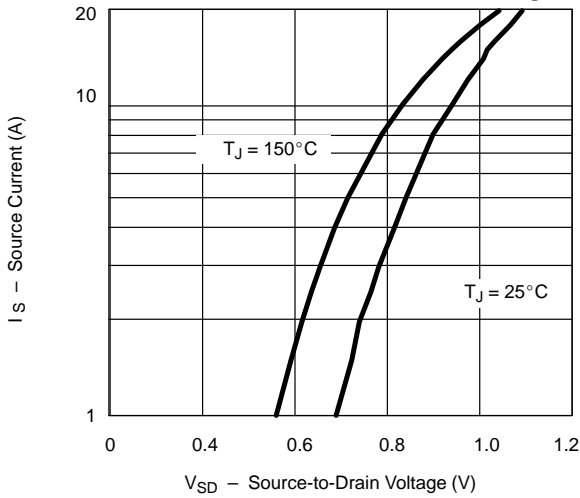

On-Resistance vs. Gate-to-Source Voltage

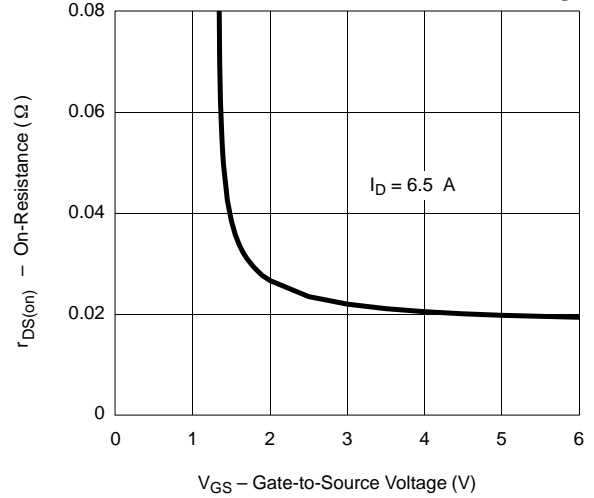

Threshold Voltage

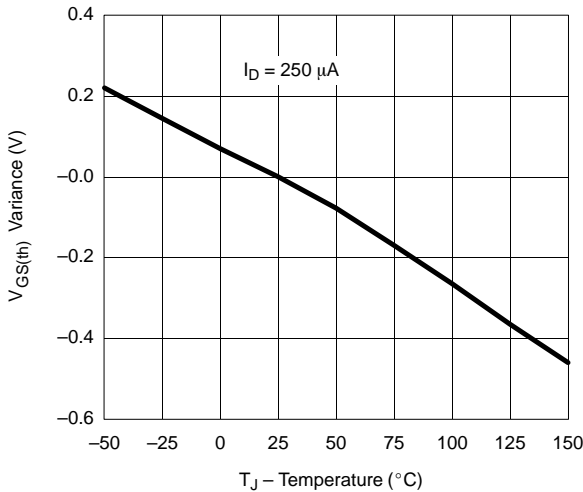

Single Pulse Power, Junction-to-Ambient

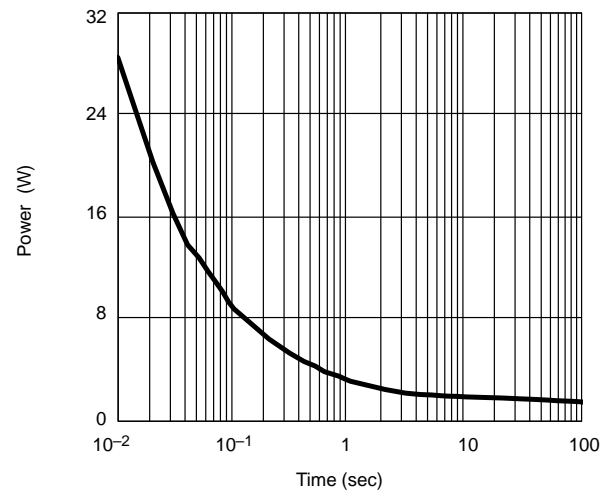

Normalized Thermal Transient Impedance, Junction-to-Ambient

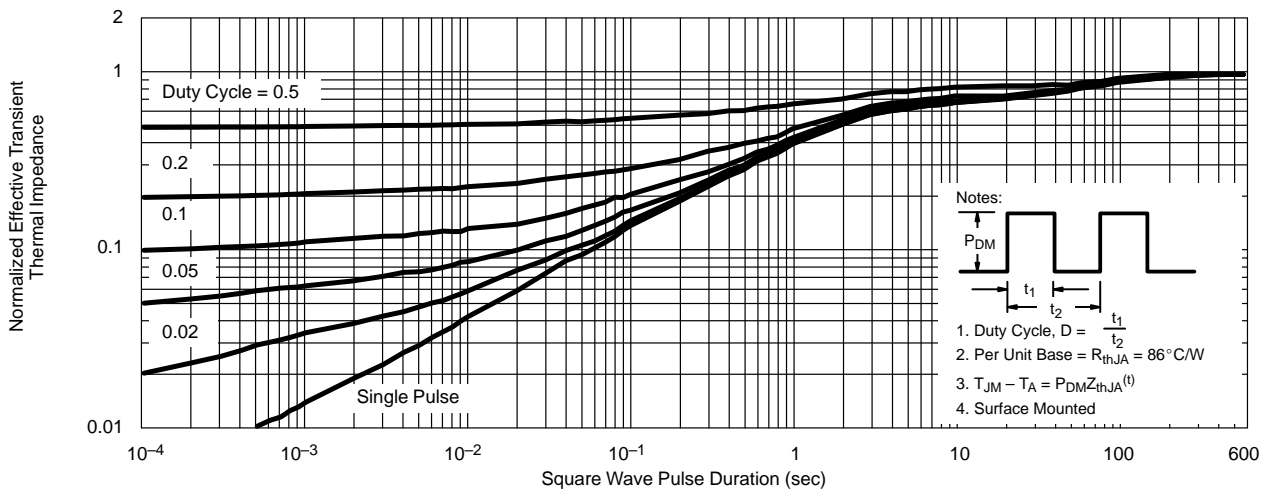



TYPICAL CHARACTERISTICS (25°C UNLESS NOTED)

