

Description

The ZXCT1023 is a precision high-side current sense monitor. Using this type of device eliminates the need to disrupt the ground plane when sensing a load current.

The ZXCT1023 has a fixed internal gain of 50 and the only external component required is the external current sense resistor; this combined with its 1.2mm x 1.8mm TDFN package more than quarters the solution size of the ZXCT1010.

The wide input voltage range of 20V down to as low as 2.5V makes it suitable for a range of applications.

The combination of operation down to 2.5V and just 3.5µA quiescent current makes it ideal for single cell Li-Ion/polymer battery charge/discharge measurement applications.

Features

- Accurate high-side current sensing
- Fixed gain of 50 output scaling
- 2.5V – 20V operating range
- 3.5µA quiescent current
- TDFN1218 package

Pin Assignments

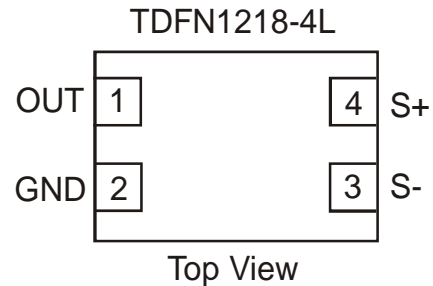

Applications

- Battery capacity measurement
- Battery chargers
- Over-current monitor

Typical Application Circuit

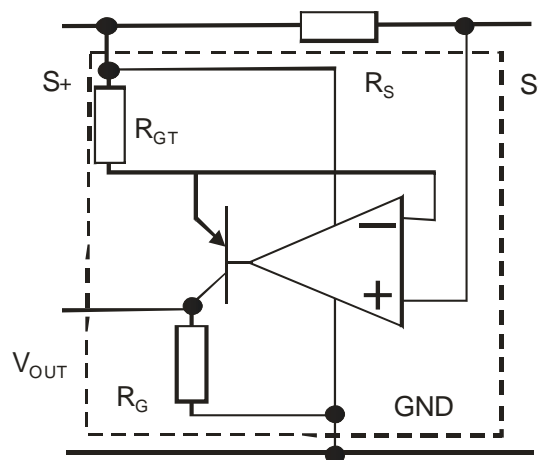

Pin Descriptions

Pin Name	Pin Number	Description
1	OUT	Voltage output. The output voltage is referenced to GND. The overall voltage gain is 50, i.e., $V_{OUT} = 50 \times V_{SENSE}$ where $V_{SENSE} = V_{S+} - V_{S-}$.
2	GND	Ground and substrate connection of device
3	S-	High impedance negative sense voltage input
4	S+	Positive sense input. Also acts as power supply pin to ZXCT1023
	Central Paddle	Substrate. Connect to GND

Absolute Maximum Ratings

Description	Rating	Unit
Voltage on S+ (Note 1)	-0.5 to 20	V
Voltage on S- (Note 1, 2), OUT (Note 1)	-0.5 V_{S+} + 0.5	V
V_{SENSE} (Note 3)	-0.5 to +2.5	V
Junction Temperature	-40 to 125	°C
Storage Temperature	-55 to 150	°C
Package Power Dissipation ($T_A = 25^\circ\text{C}$) TDFN1218		mW
ESD Ratings		
Human Body Model	2000	V
Machine Model	150	V

These are stress ratings only. Operation outside the absolute maximum ratings may cause device failure. Operation at the absolute maximum rating for extended periods may reduce device reliability. Semiconductor devices are ESD sensitive and may be damaged by exposure to ESD events. Suitable ESD precautions should be taken when handling and transporting these devices.

- Notes:
1. Measured with respect to GND pin
 2. Subject to absolute maximum V_{SENSE} not being exceeded.
 3. V_{SENSE} is defined as the voltage difference across the sense resistor, R_S .
 4. The usable V_{SENSE} range is limited by the output voltage range; and as such will be reduced at lower V_{S+} values.

Recommended Operating Conditions ($T_A = 25^\circ\text{C}$)

Symbol	Parameter	Min	Max	Unit
V_{S+} (Note 1)	Common-Mode Sense Input Range	2.5	20	V
V_{SENSE}	Differential Sense Input Voltage Range	0	380 (Note 4)	mV
V_{OUT}	Output Voltage Range	0	$V_{S-} - 1$	V
T_A	Ambient Temperature Range	-40	85	°C

Electrical Characteristics ($T_A = 25^\circ\text{C}$, $V_{S+} = 3.6\text{V}$, $V_{\text{SENSE}} = 50\text{mV}$, unless otherwise stated)

Symbol	Parameter	Conditions	Limits			Unit
			Min.	Typ.	Max.	
V_{OUT}	Output voltage	$V_{\text{SENSE}} = 0\text{mV}$		0.3	50	mV
		$V_{\text{SENSE}} = 10\text{mV}$	425	500	575	V
		$V_{\text{SENSE}} = 30\text{mV}$	1.41	1.5	1.59	
		$V_{\text{SENSE}} = 50\text{mV}$	2.425	2.5	2.575	
		$V_{\text{SENSE}} = 100\text{mV}$, $V_{S+} = 20\text{V}$	4.85	5	5.15	
TC (Note 5)	Output voltage temperature coefficient			50	300	ppm/ $^\circ\text{C}$
I_Q	Ground pin current	$V_{\text{SENSE}} = 0\text{V}$		3.5	8	μA
I_{S-}	SENSE- input current	$V_{\text{SENSE}} = 0\text{V}$			100	nA
Acc	Accuracy	$V_{\text{SENSE}} = 50\text{mV}$	-3		3	%
Gain	$V_{\text{OUT}}/V_{\text{SENSE}}$	$V_{\text{SENSE}} = 50\text{mV}$		50		V/V
R_{OUT}	Output resistance			15		k Ω
BW	Bandwidth	$V_{\text{SENSE}} (\text{DC}) = 10\text{mV}$		300		kHz
		$V_{\text{SENSE}} (\text{DC}) = 50\text{mV}$		1		MHz
PSRR (Note 6)	Power supply rejection ratio	$V_{\text{SENSE}} = 30\text{mV}$, $V_{S+} = 2.5$ to 20V	50	60		dB

- Notes
5. TC limits are determined by characterization.
 6. PSRR is defined as change in output voltage per change in $S+$ voltage, V_{S+} .

Typical DC Characteristics

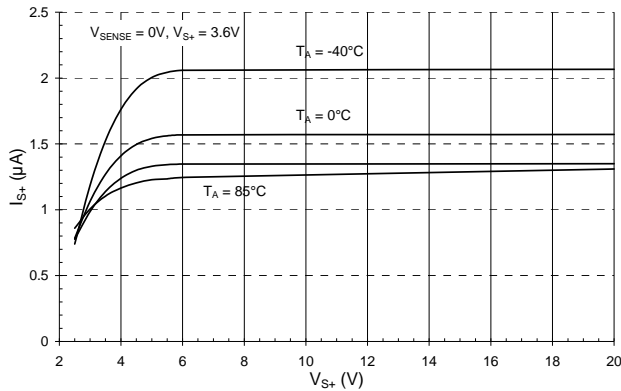

S+ Input Current vs. Supply voltage

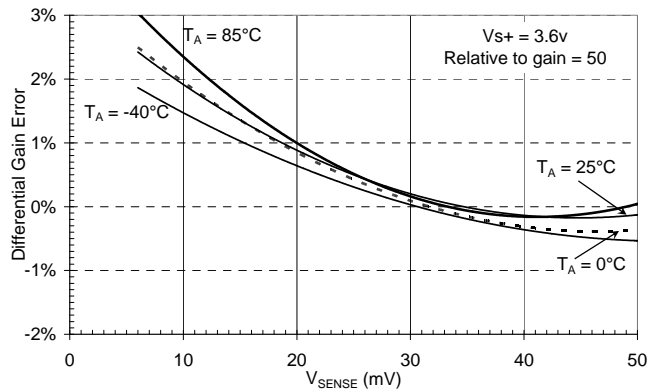

Normalised Gain Error vs. Sense Voltage

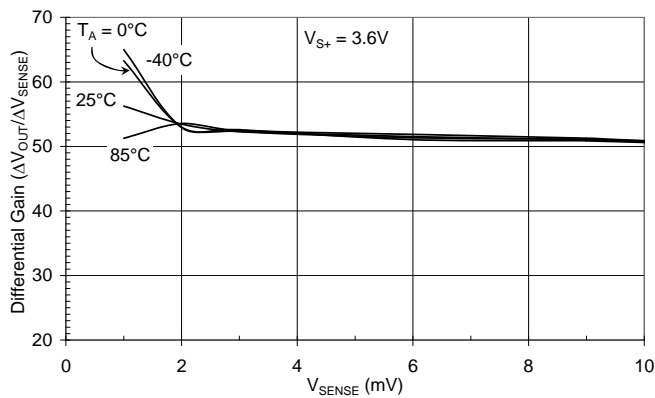

Differential Gain vs. Sense Voltage

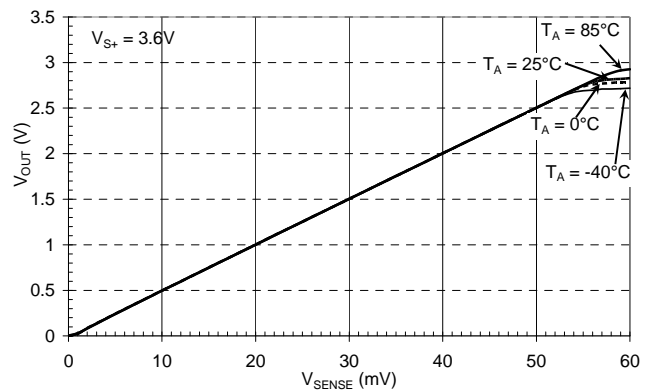

Output Voltage vs. Sense Voltage

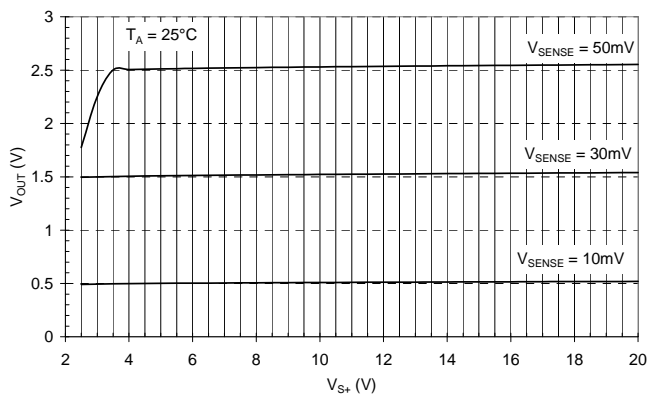

Output Voltage vs. Input voltage

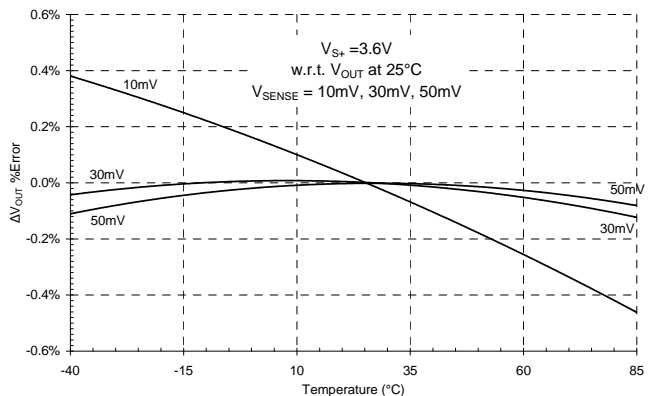

Relative Output Voltage Change vs. Temperature

Typical AC Characteristics

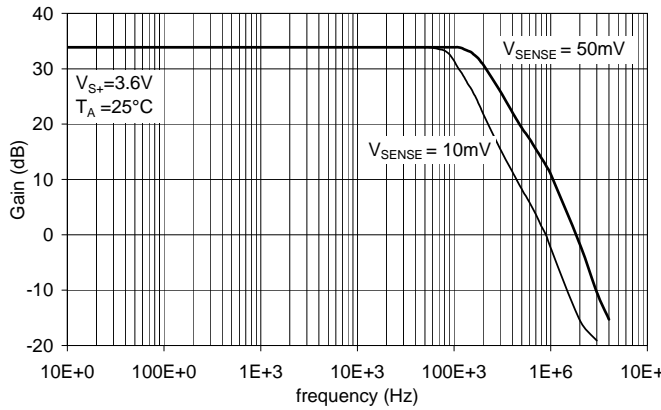

Small Signal Frequency Response

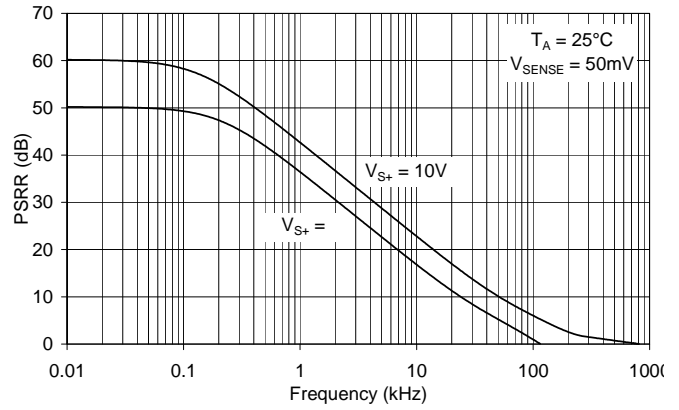

Power Supply Rejection Ratio

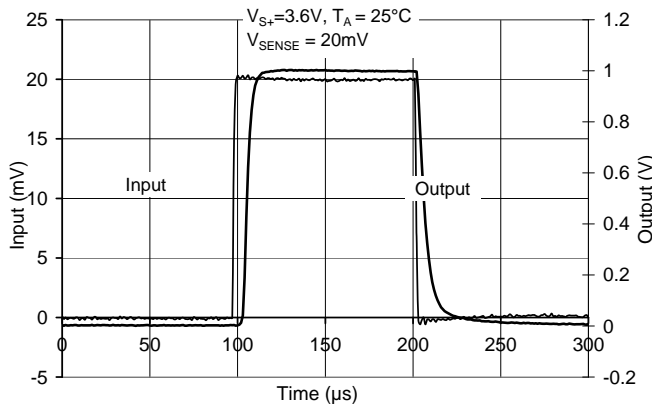

Large Signal Pulse Response 20mV

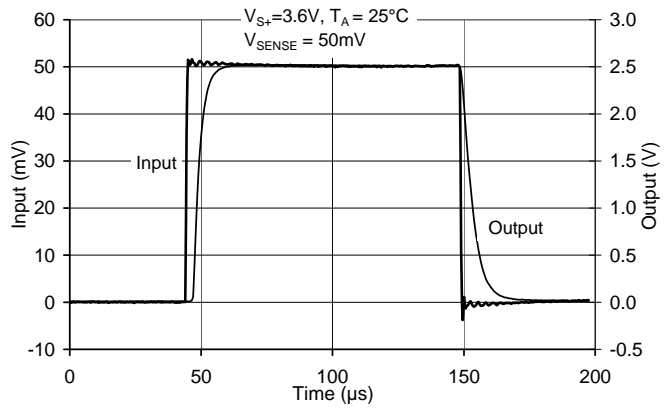

Large Signal Pulse Response 50mV

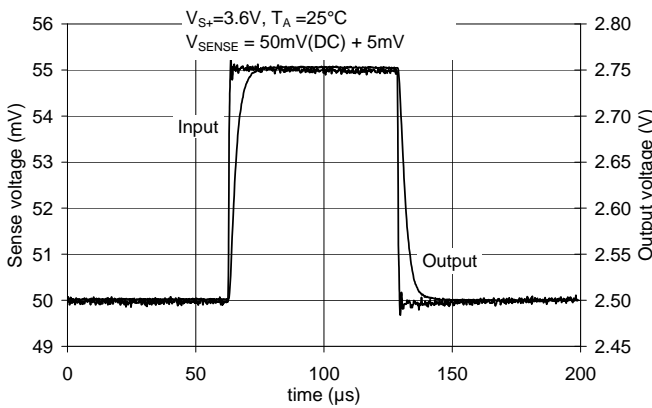

Small Signal Positive Pulse Response

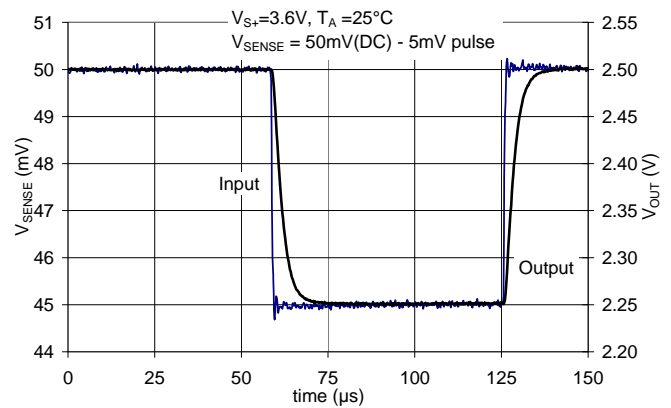

Small Signal Negative Pulse Response

Application Information

The ZXCT1023 is line powered (derives its power from the rail being sensed) this reduces the number of pins used and PCB trace routing. The fixed gain of 50 reduces the PCB area by reducing the number of external components. The only external component required is the sense resistor. This coupled with the 1.2mm x 1.8mm TDFN package makes the solution size very small.

The fixed gain of 50 has been chosen to meet the normal requirements of most applications.

The ZXCT1023 has its gain setting resistor, R_G , set at 15k Ω which further reduces power consumption at larger V_{SENSE} .

Application Examples

Please refer to Zetex AN39 for sample applications.

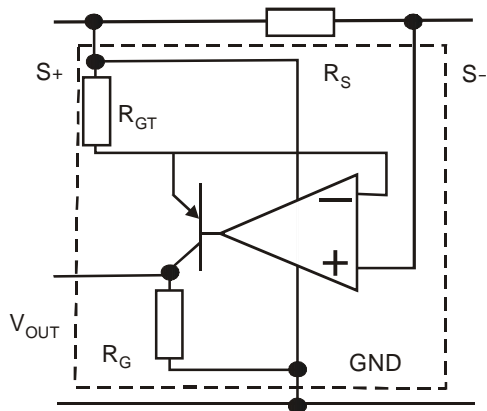

Ordering Information

Order Reference	Package	Device Marking	Status	Reel Size (inches)	Quantity Per Reel	Tape Width (mm)
ZXCT1023DFGTA	TDFN1218	23	Active	7	3000	8

Package Outline Dimensions (All Dimensions in mm)

TDFN1218-4

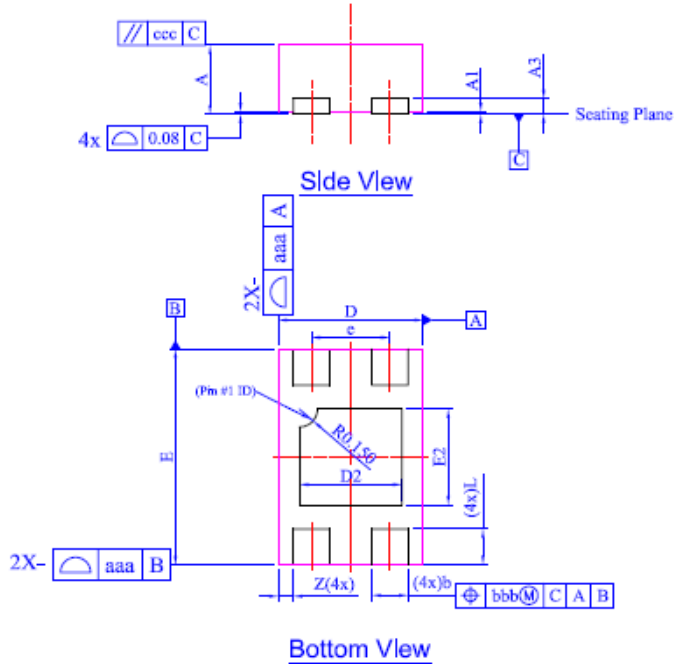

Dim	Min	Max	Typ
D	1.15	1.25	1.20
E	1.75	1.85	1.80
D2	0.75	0.95	0.85
E2	0.70	0.90	0.80
A	0.545	0.605	0.575
A1	0	0.05	0.02
A3	—	—	0.13
b	0.25	0.35	0.30
L	0.25	0.35	0.30
e	—	—	0.65
Z	—	—	0.125
aaa	0.25		
bbb	0.10		
ccc	0.10		

Recommended PCB Land Pattern

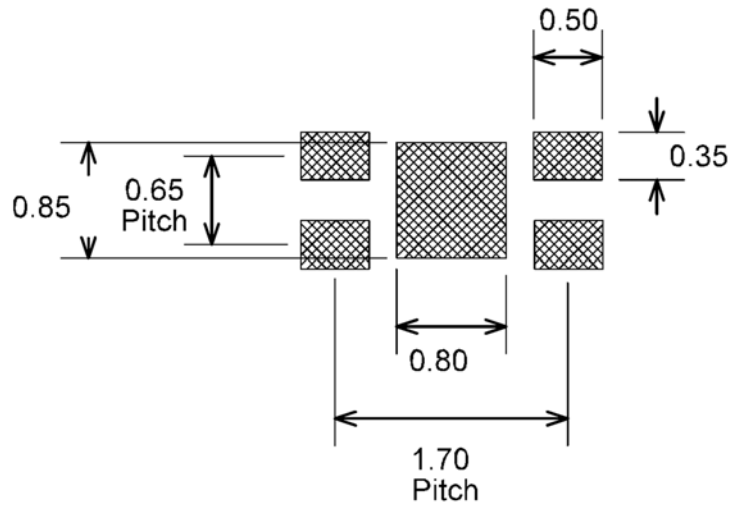

IMPORTANT NOTICE

DIODES INCORPORATED MAKES NO WARRANTY OF ANY KIND, EXPRESS OR IMPLIED, WITH REGARDS TO THIS DOCUMENT, INCLUDING, BUT NOT LIMITED TO, THE IMPLIED WARRANTIES OF MERCHANTABILITY AND FITNESS FOR A PARTICULAR PURPOSE (AND THEIR EQUIVALENTS UNDER THE LAWS OF ANY JURISDICTION).

Diodes Incorporated and its subsidiaries reserve the right to make modifications, enhancements, improvements, corrections or other changes without further notice to this document and any product described herein. Diodes Incorporated does not assume any liability arising out of the application or use of this document or any product described herein; neither does Diodes Incorporated convey any license under its patent or trademark rights, nor the rights of others. Any Customer or user of this document or products described herein in such applications shall assume all risks of such use and will agree to hold Diodes Incorporated and all the companies whose products are represented on Diodes Incorporated website, harmless against all damages.

Diodes Incorporated does not warrant or accept any liability whatsoever in respect of any products purchased through unauthorized sales channel.

Should Customers purchase or use Diodes Incorporated products for any unintended or unauthorized application, Customers shall indemnify and hold Diodes Incorporated and its representatives harmless against all claims, damages, expenses, and attorney fees arising out of, directly or indirectly, any claim of personal injury or death associated with such unintended or unauthorized application.

Products described herein may be covered by one or more United States, international or foreign patents pending. Product names and markings noted herein may also be covered by one or more United States, international or foreign trademarks.

LIFE SUPPORT

Diodes Incorporated products are specifically not authorized for use as critical components in life support devices or systems without the express written approval of the Chief Executive Officer of Diodes Incorporated. As used herein:

A. Life support devices or systems are devices or systems which:

1. are intended to implant into the body, or
2. support or sustain life and whose failure to perform when properly used in accordance with instructions for use provided in the labeling can be reasonably expected to result in significant injury to the user.

B. A critical component is any component in a life support device or system whose failure to perform can be reasonably expected to cause the failure of the life support device or to affect its safety or effectiveness.

Customers represent that they have all necessary expertise in the safety and regulatory ramifications of their life support devices or systems, and acknowledge and agree that they are solely responsible for all legal, regulatory and safety-related requirements concerning their products and any use of Diodes Incorporated products in such safety-critical, life support devices or systems, notwithstanding any devices- or systems-related information or support that may be provided by Diodes Incorporated. Further, Customers must fully indemnify Diodes Incorporated and its representatives against any damages arising out of the use of Diodes Incorporated products in such safety-critical, life support devices or systems.

Copyright © 2011, Diodes Incorporated

www.diodes.com