

SPECIFICATION

- Part No. : **MA700.A.ABC.002**
- Product Name : Pantheon Antenna 3in1 MA.700
Screw-Mount (Permanent Mount)
GPS/GLONASS / LTE Cellular / 2.4GHz / 5GHz
Combination Antenna
- Features : Highest Efficiency/Peak Gain
Omni-directional Outdoor IP67 Antenna
Advanced RF Design and Materials
Heavy Duty – Integrated Metal
Base/Ground-plane
Custom cables and connectors available
RoHS ✓



1. Introduction

The Pantheon MA700 antenna is an omni-directional heavy-duty, fully IP67 waterproof external M2M antenna for use in telematics, transportation and remote monitoring applications. The Pantheon series is designed for RF professionals who accept no performance compromises whatsoever. The MA700 combines a 3in1 GPS/GLONASS, Cellular 700MHz to 2200MHz (2G/3G/4G) and 2.4GHz/5GHz antenna with the highest efficiency and peak gain possible. Unlike our competitors who don't measure cable loss the specification is measured at 3 meters (10ft) to show real performance in the field. The antenna screws down permanently onto a roof or metal panel and can be pole or wall-mounted.

All while still maintaining 20dB isolation between antennas. It uses high-shielded PTFE dielectric ultra low-loss cables that maintain low attenuation at all frequency bands, and high noise rejection, with an average loss of only 0.3dB per meter (0.1dB per foot), compared to 0.7dB for RG58 and 1.2dB for RG174. Because of this, the Pantheon maximizes chances of passing PTCRB and network approvals first time. The Pantheon also has excellent performance without need to attach to an external ground-plane due to its internal antennas coupling to its unique super strong integrated metal base. The antenna comes with a 3M adhesive waterproof layer to prevent water leaking under the antenna into the mounting hole. The Pantheon can also be supplied in single GPS/.GLONASS, Cellular, Wi-Fi only versions, or at other frequencies.

Custom designed integrated wall mounted and pole mounted brackets are available for the Pantheon antennas. These patent pending mounts allow for 180 degrees freedom of movement of the antennas for ease of positioning while also preventing access to the cables so they cannot be cut by vandals or thieves and also protecting the cables from long term weather exposure. The removal of unsightly cables also leads to a cleaner more professional installation and look, and makes the antenna less identifiable and more unobtrusive. Customized cable sleeves can be supplied for extra protection where required.



Note: for ground-isolation antennas use the MA705 version with Isolation Gaskets.

2. Specification

GPS-GLONASS						
Centre Frequency	1575.42MHz / 1602MHz					
Bandwidth	10MHz					
Radiation Efficiency	50(without cable)					
Passive Gain @ Zenith	4.0 typ(with $\psi=140\text{mm}$ ground)					
VSWR	2					
Impedance	50 Ω					
DC Power Input Range	3 ~ 5V					
DC input	3.3V		4.0V		5.5V	
MHz	1575.42	1602	1575.42	1602	1575.42	1602
VSWR	2	2	2	2	2	2
LNA Gain	29.2	29	31	31	32.3	32
Noise Figure	3.1	3.1	3.2	3.2	3.4	3.4
Power Consumption	7.5	7.5	9.4	9.4	15	15
Band Attenuation	1520MHz: -20dB 1642MHz: -20dB		1520MHz: -20dB 1642MHz: -20dB		1520MHz: -20dB 1642MHz: -20dB	
Cable	3m RG-174 standard, fully customizable					
Connector	SMA(M) standard, fully customizable					

CELLULAR ANTENNA						
Frequency (MHz)	700~ 800	824 ~ 896	880 ~ 960	1710~ 1880	1850~1990	1710~2170
Peak Gain (dBi)	2.4	1.6	1.7	2.1	2.4	2.4
Average Gain (dBi)	-1.3	-2.0	-2.3	-2.8	-2.7	-2.7
Efficiency	73%	61%	58%	52%	52%	52%
Impedance	50 Ω					
Polarization	Linear					
Radiation Pattern	Omni					
Cable	3m CFD200 standard, fully customizable					
Connector	SMA(M) standard, standard, fully customizable					

2.4GHz / 5GHz ANTENNA				
Frequency (GHz)	2.4 ~ 2.5	4.7 ~ 5.0	5.0 ~ 5.4	5.4 ~ 5.9
Peak Gain (dBi)	2.1	2.9	3.8	2.8
Average Gain (dBi)	-2.3	-3.6	-3.3	-3.8
Efficiency	60%	44%	46%	42%
VSWR	<=1.7:1			
Impedance	50Ω			
Polarization	Linear			
Radiation Pattern	Omni			
Cable	3m CFD200 standard, fully customizable			
Connector	RP-SMA(M) standard, standard, fully customizable			
MECHANICAL				
Dimensions	Height 85.7mm x Diameter 145.6mm			
Casing	Wonderloy PC-540 PC/ABS Alloy			
Base and thread	CAN10 Zinc Alloy			
Thread diameter	M30 x 2 (30mm)			
Nut	Nickel Plated Iron			
Foam	3M 9448HK			
Waterproof	IP67			
ENVIRONMENTAL				
Operation Temperature	-30°C to 85°C			
Storage Temperature	-40°C to 90°C			
Humidity	Non-condensing 65°C 95% RH			

* all measurement are done in free space with 3m standard cable

3. GPS/GLONASS Antenna Characteristics

3.1 Block diagram

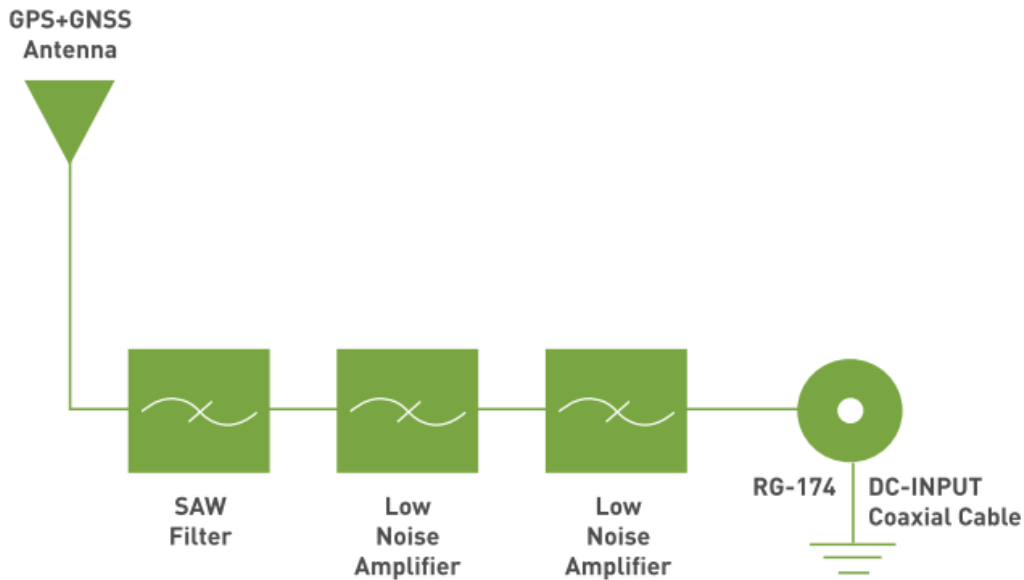

3.2 Return Loss

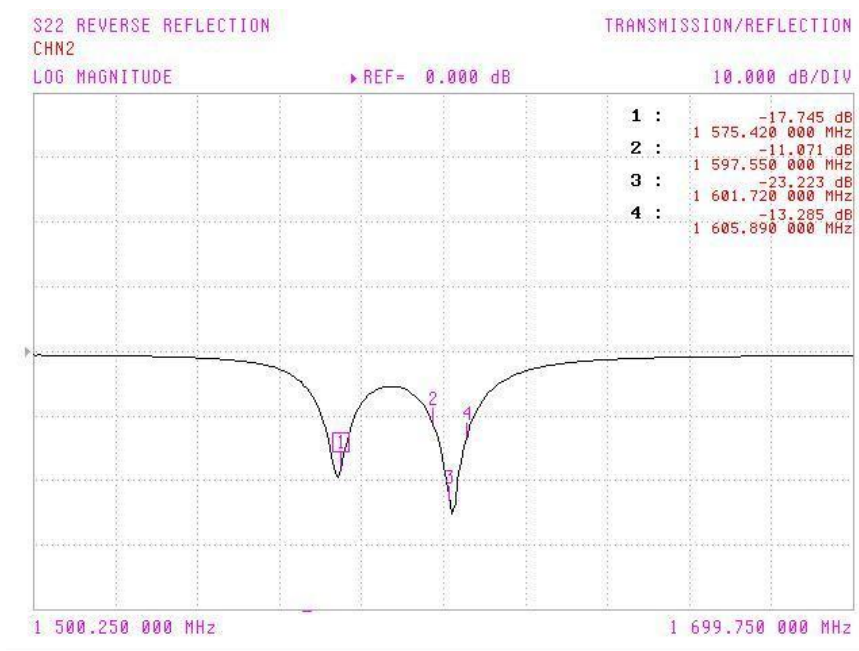

3.3 GPS/GLONASS Antenna Radiation Pattern



XYZ co-ordinate for reference.

XZ-plane Free Space @1575.42MHz

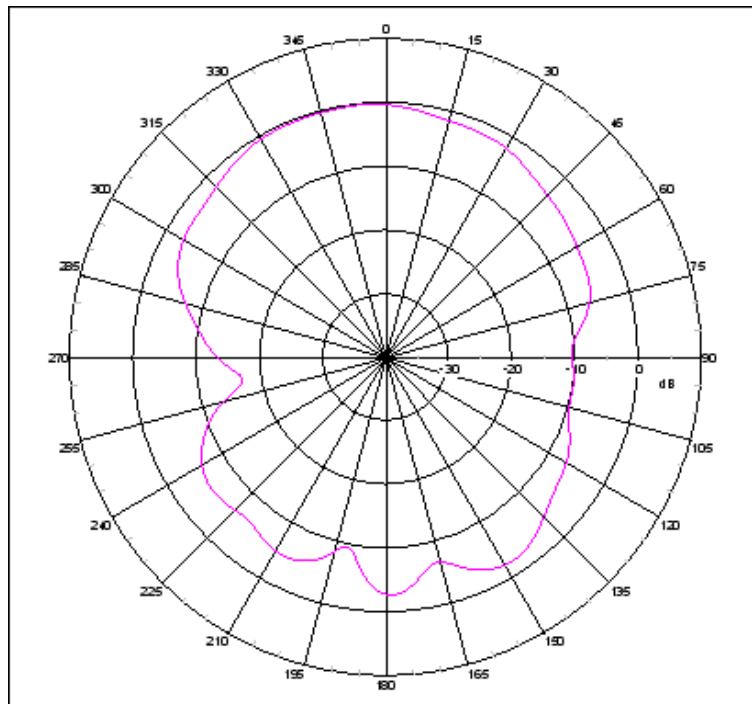

YZ-plane Free Space @1575.42MHz

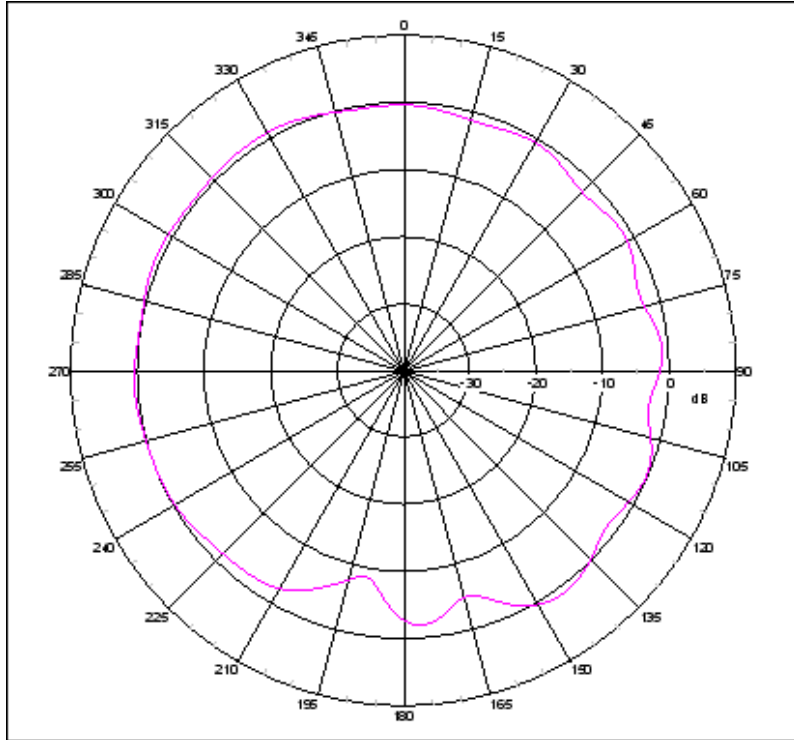

XZ-plane Free Space @1602MHz

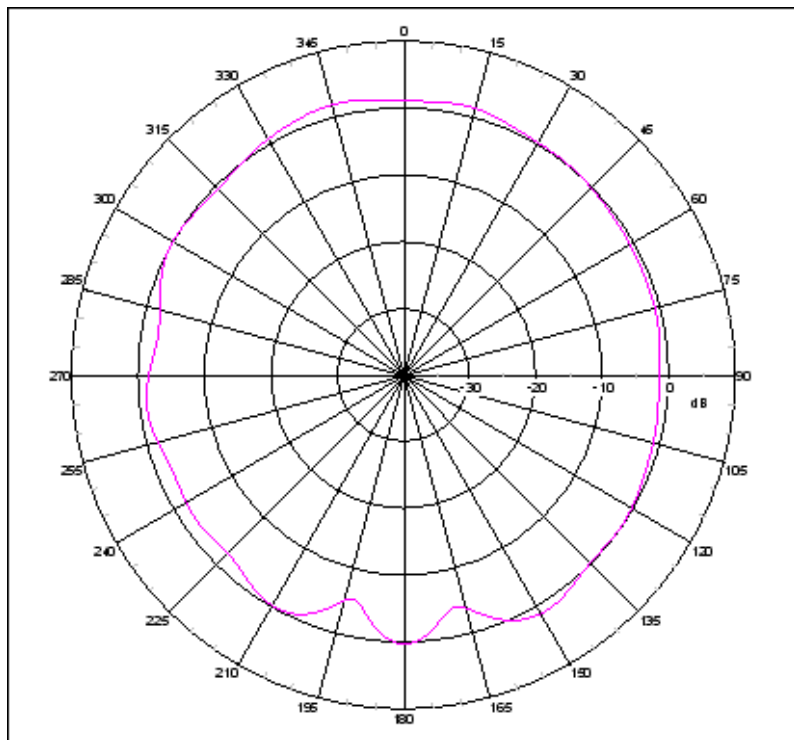



YZ-plane Free Space @1602MHz

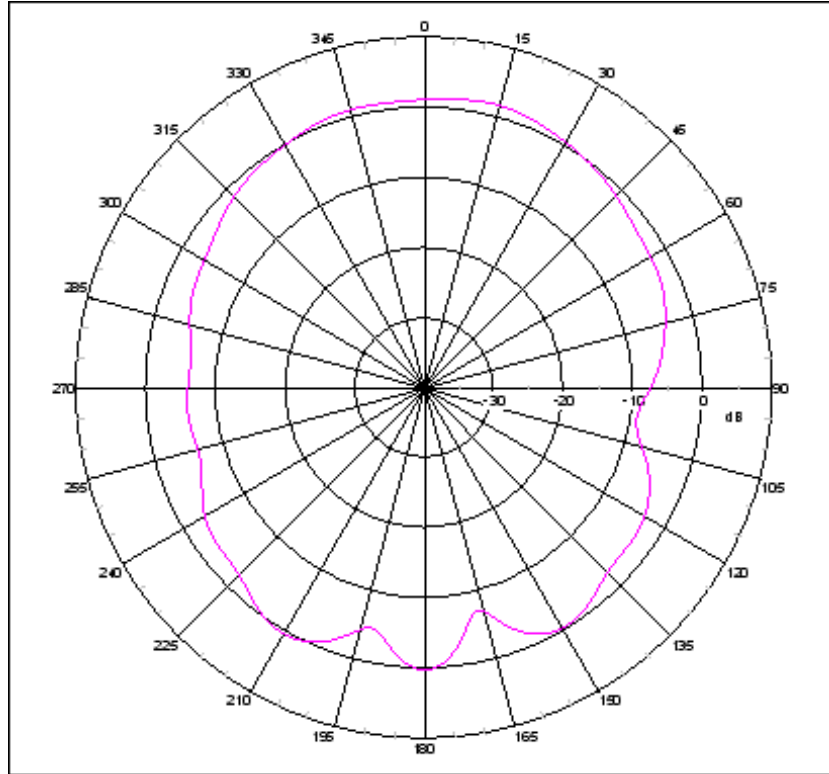

3.4 GPS/GLONASS LNA

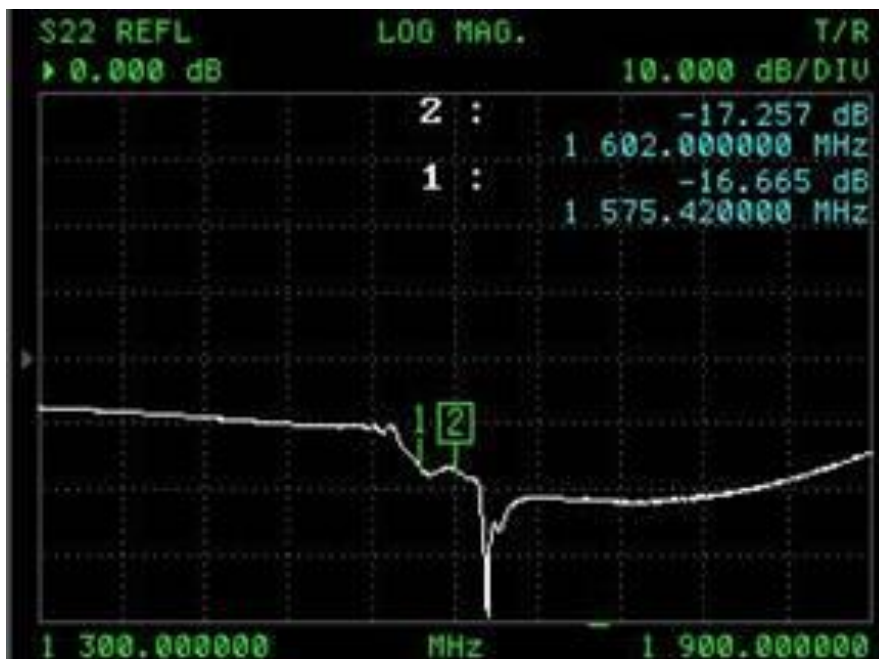
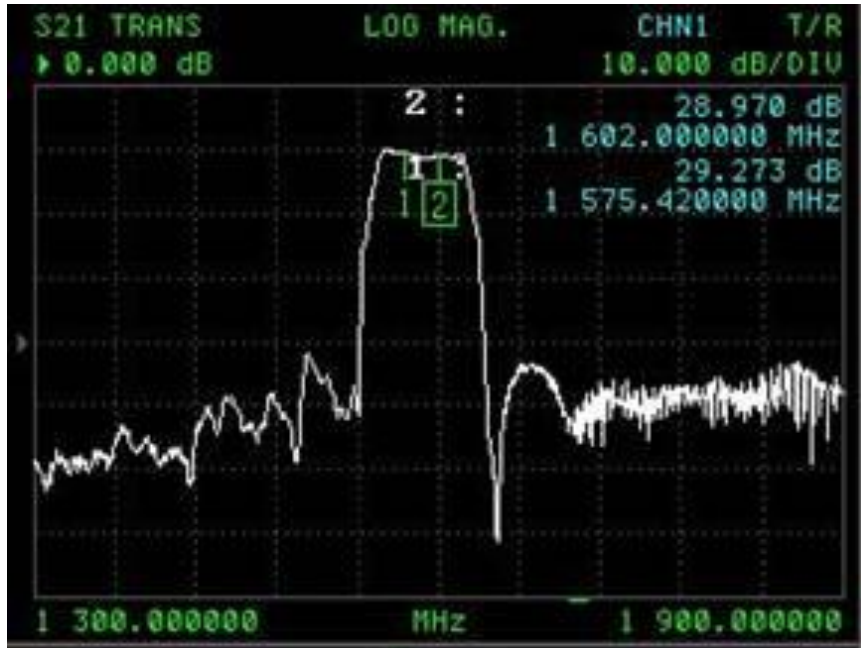

4. Cellular Antenna Characteristics

4.1 Return Loss (Free Space)

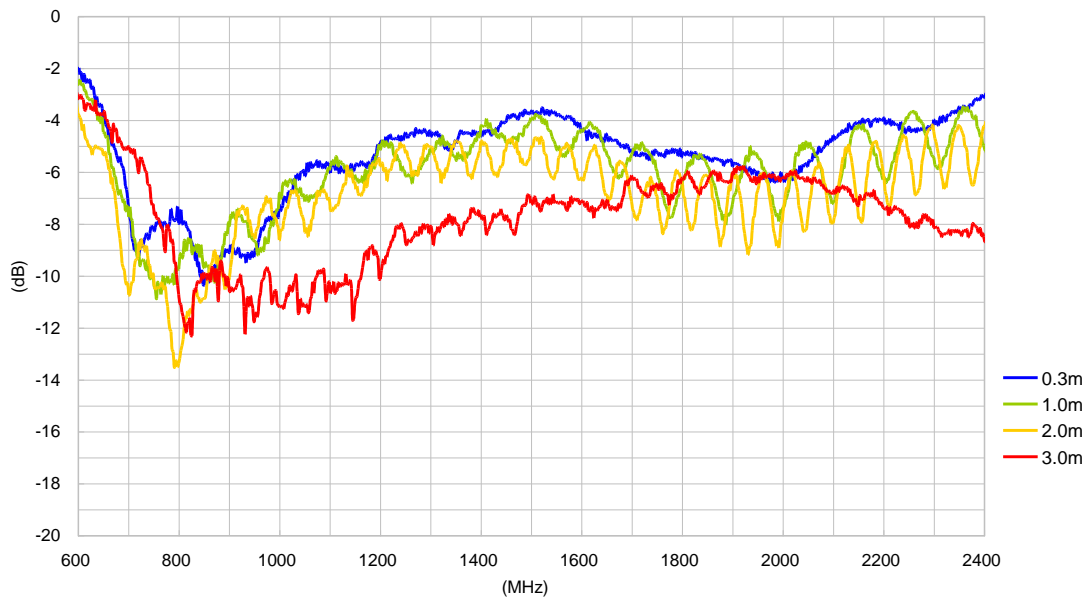

4.2 Return Loss (45 x 30cm Ground Plane)

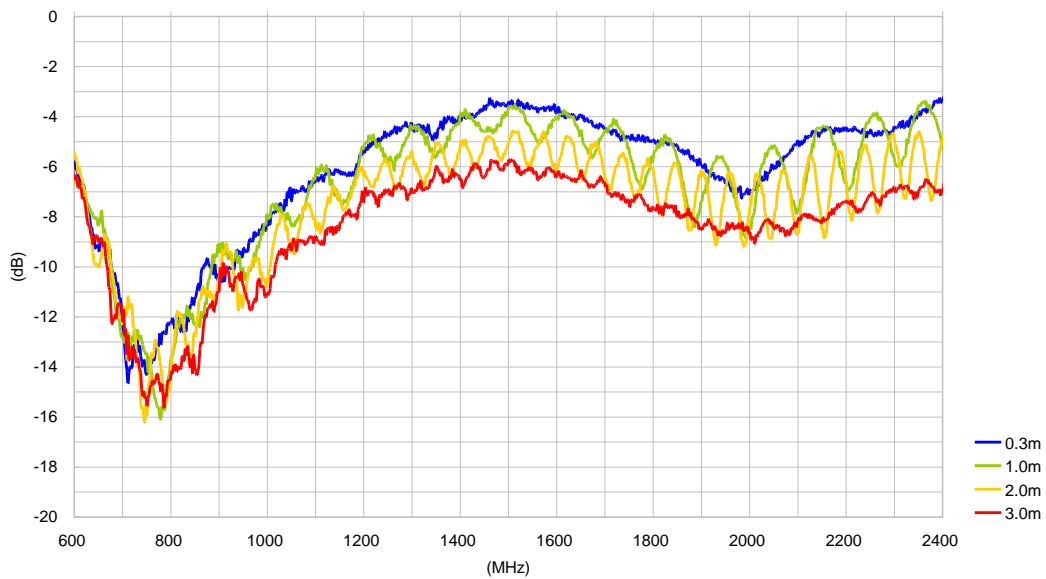

4.3 VSWR (Free Space)

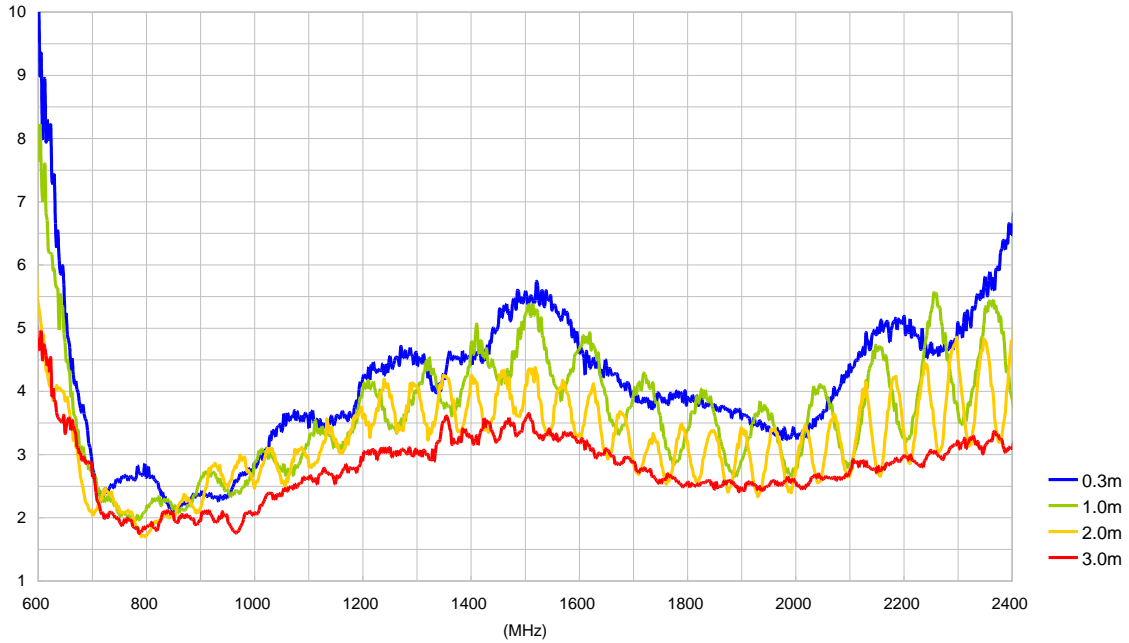

4.4 VSWR (45cm x 30cm Ground Plane)

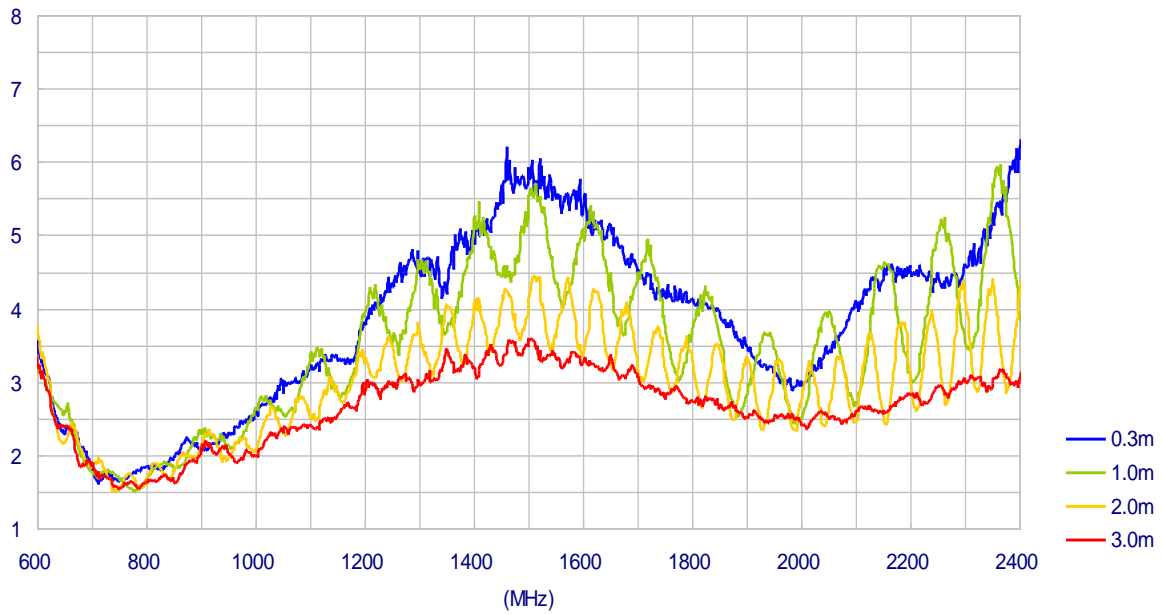

4.5 Cellular Antenna Free Space Efficiency

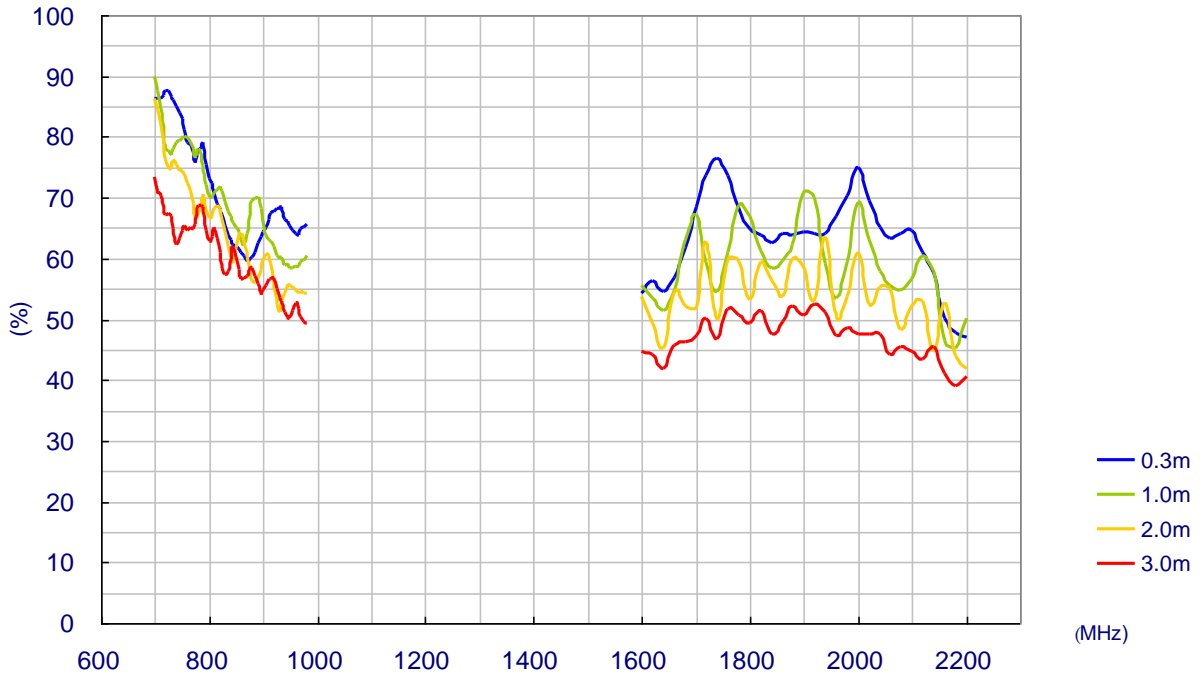

4.6 Cellular Antenna Free Space Peak Gain

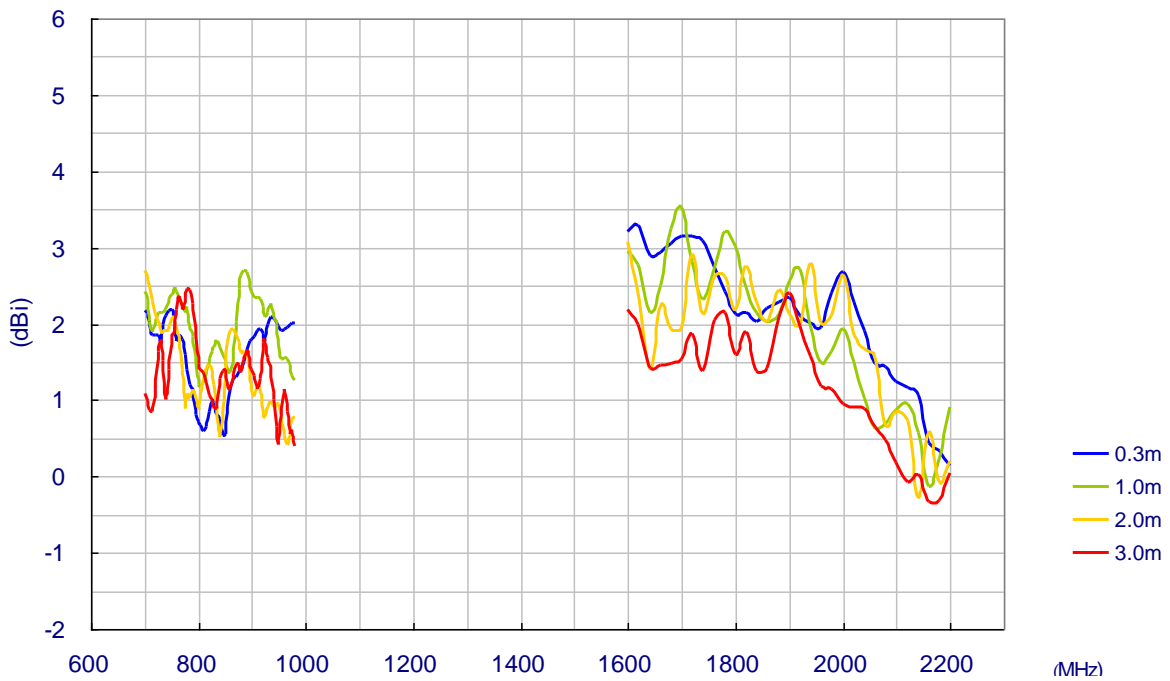

4.7 Cellular Antenna Free Space 3D Average Gain

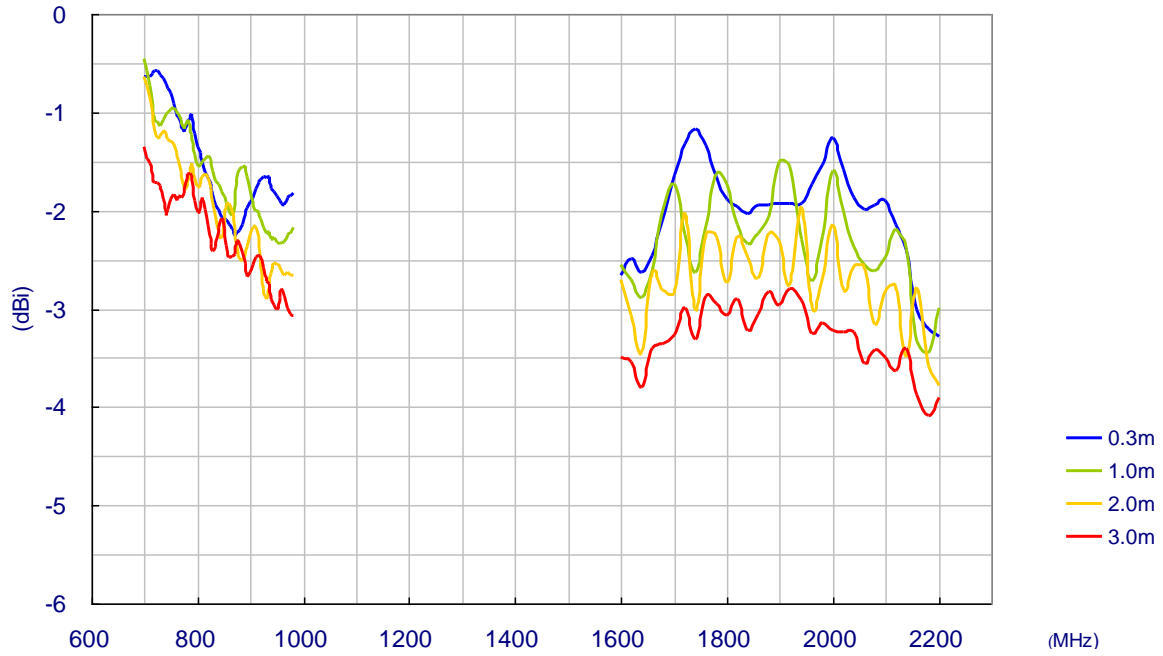

4.8 Cellular Antenna Free Space Radiation

X-Z Plane at 800MHz

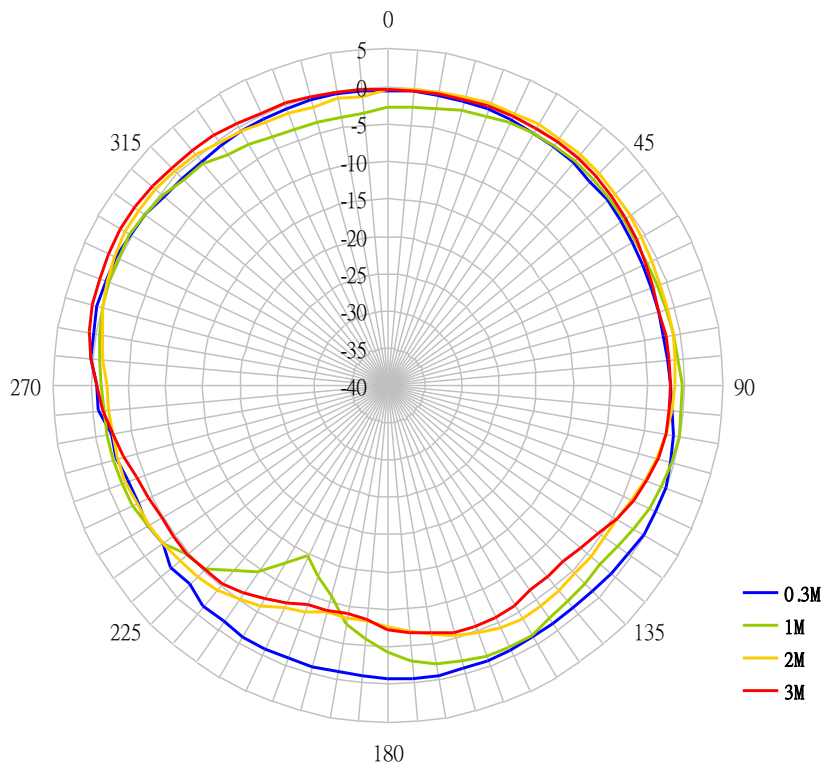



Y-Z Plane at 800MHz

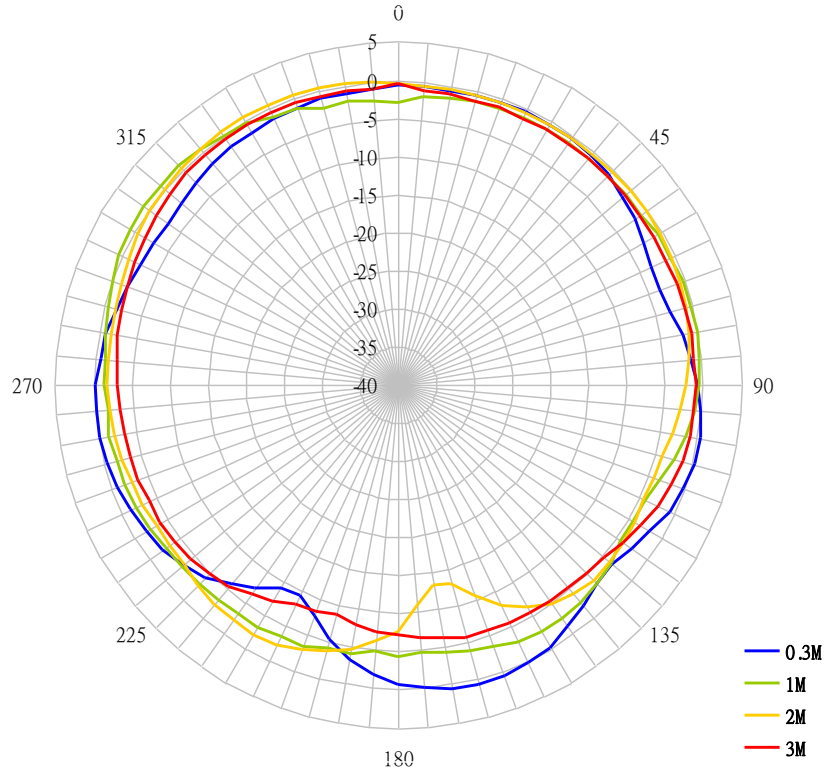

X-Y Plane at 800MHz

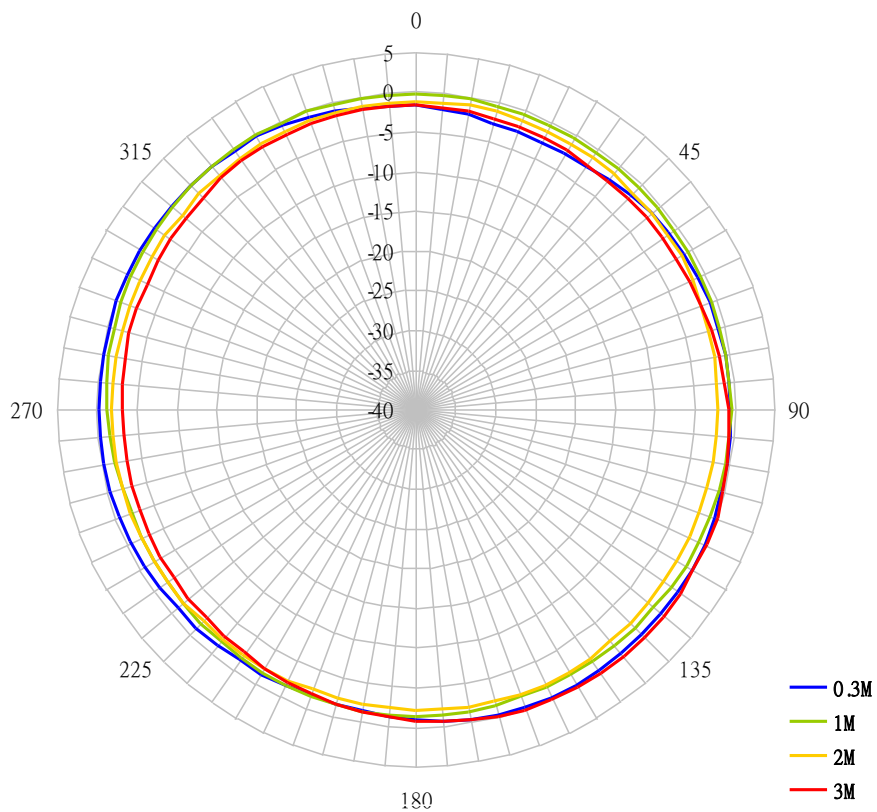



X-Z Plane at 900MHz

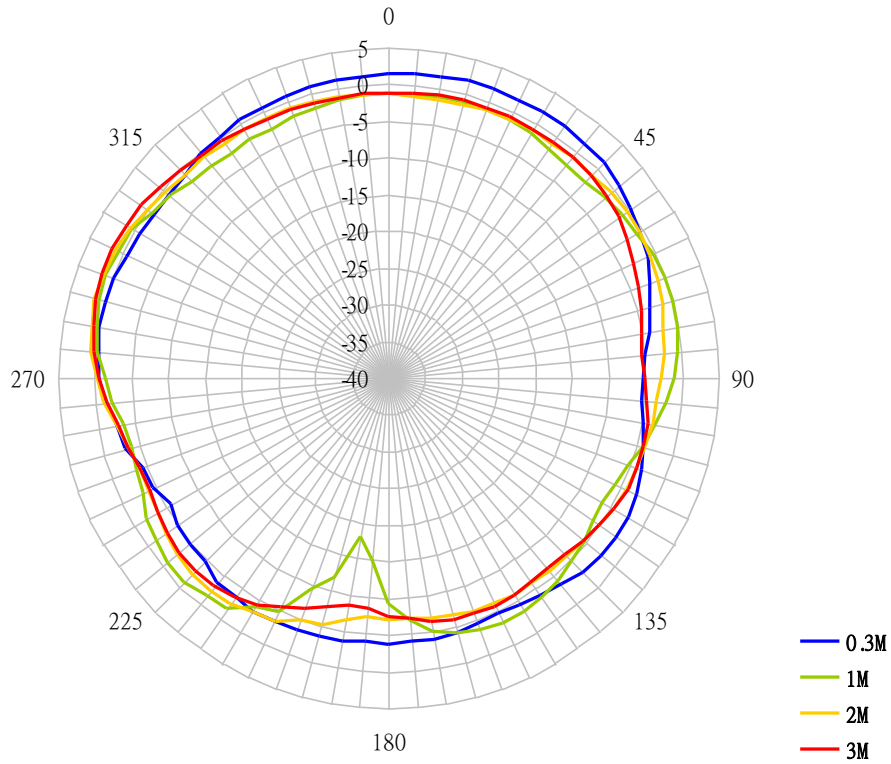

Y-Z Plane at 900MHz

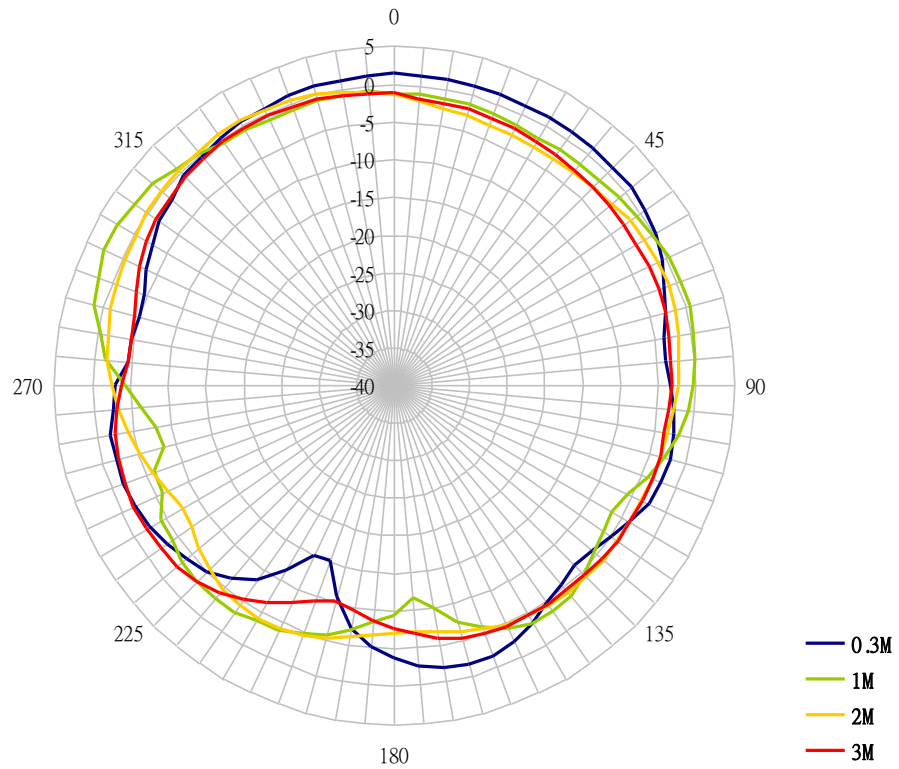

X-Y Plane at 900MHz

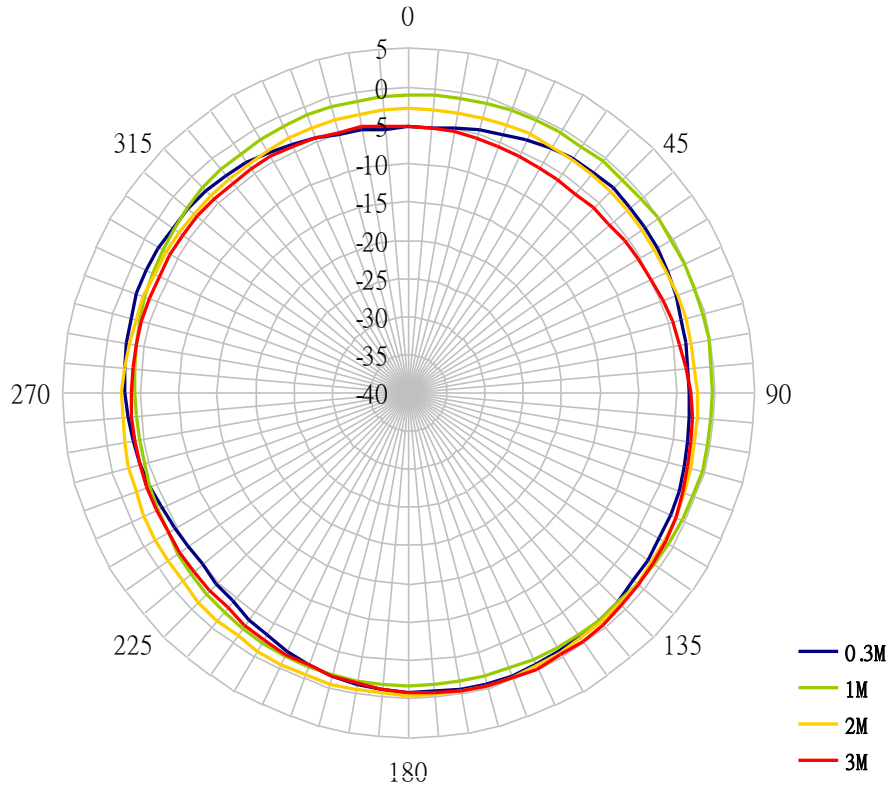

X-Z Plane at 1800MHz

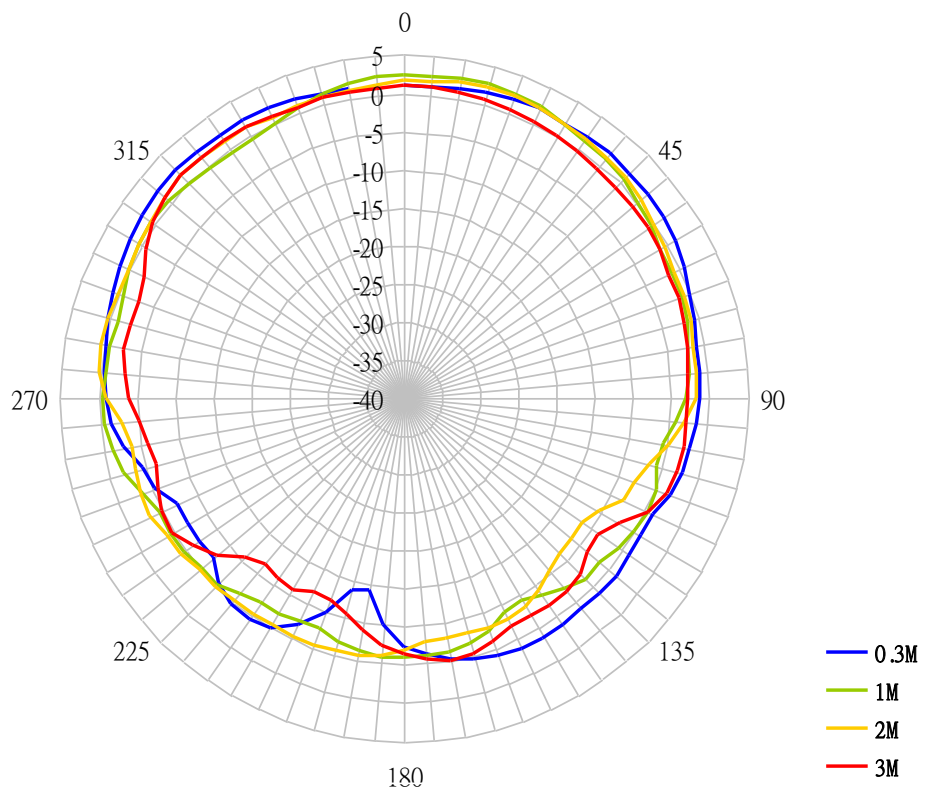

Y-Z Plane at 1800MHz

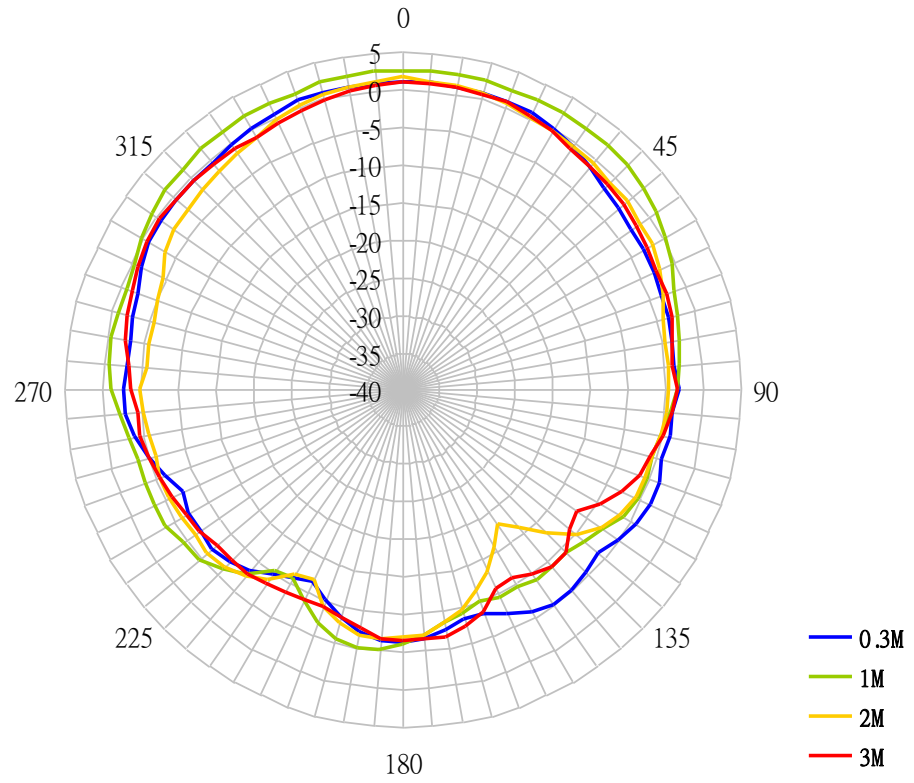

X-Y Plane at 1800MHz

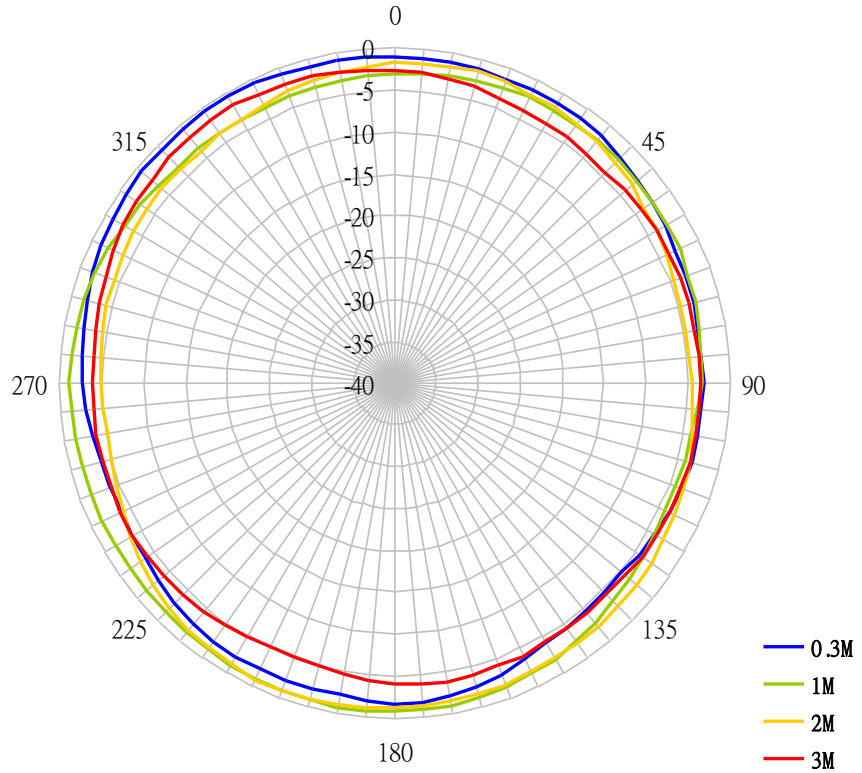

X-Z Plane at 1900MHz

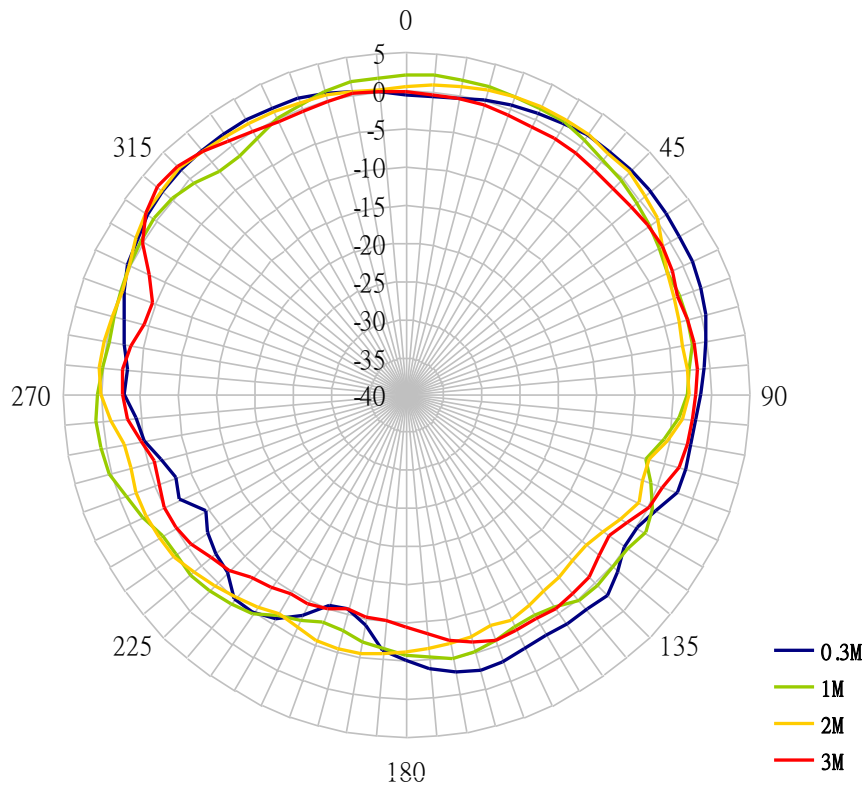

Y-Z Plane at 1900MHz

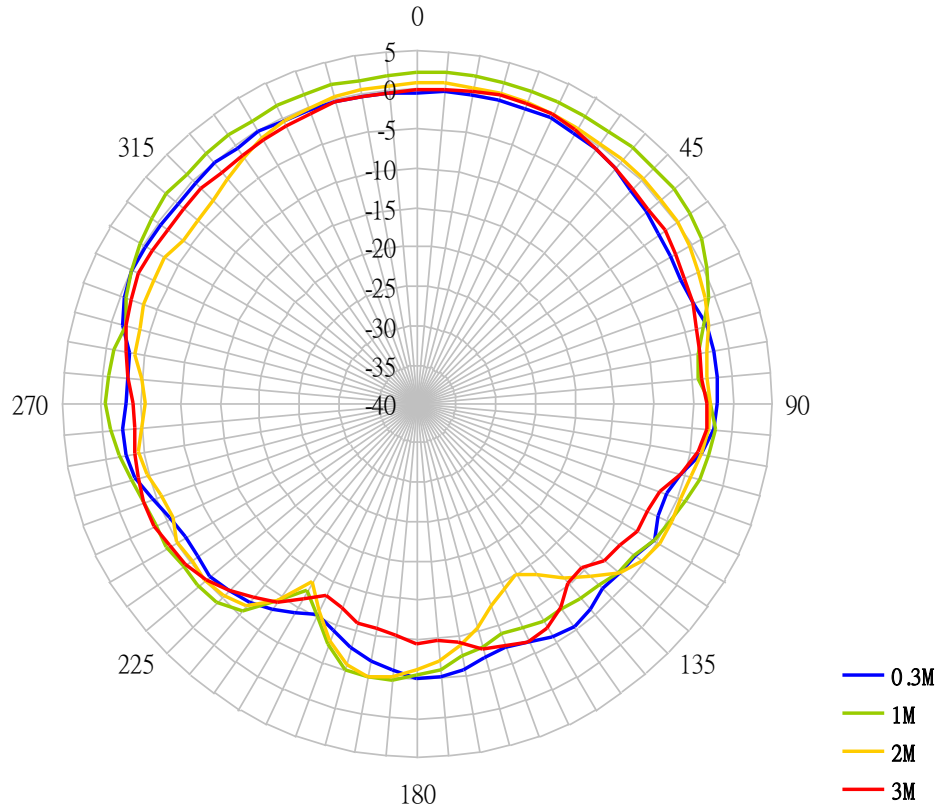

X-Y Plane at 1900MHz

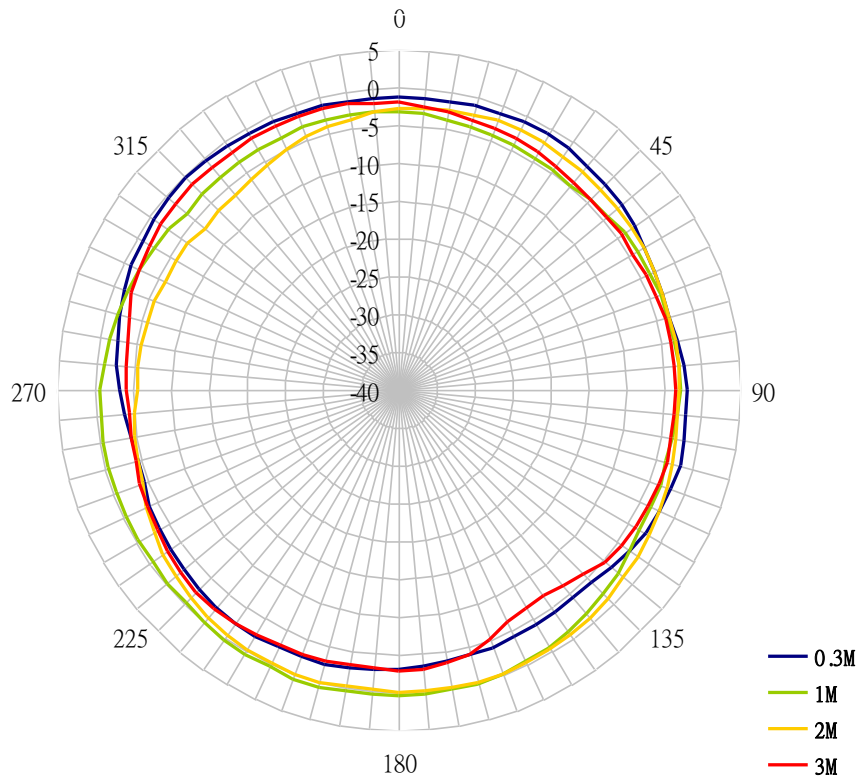



X-Z Plane at 2200MHz

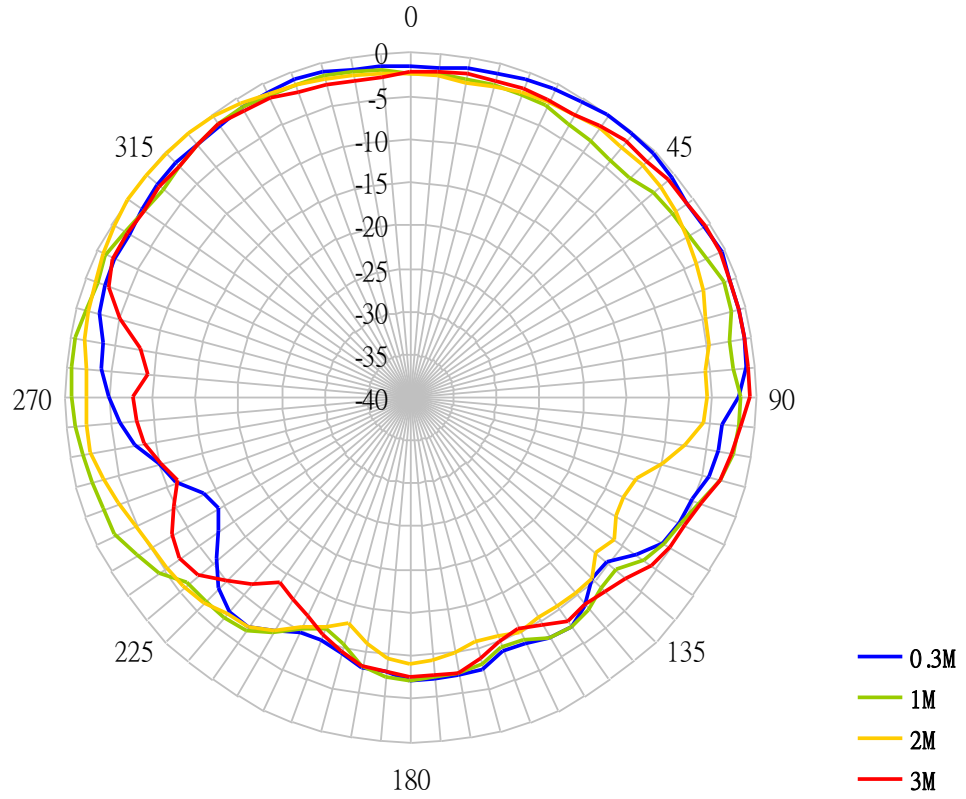

Y-Z Plane at 2200MHz

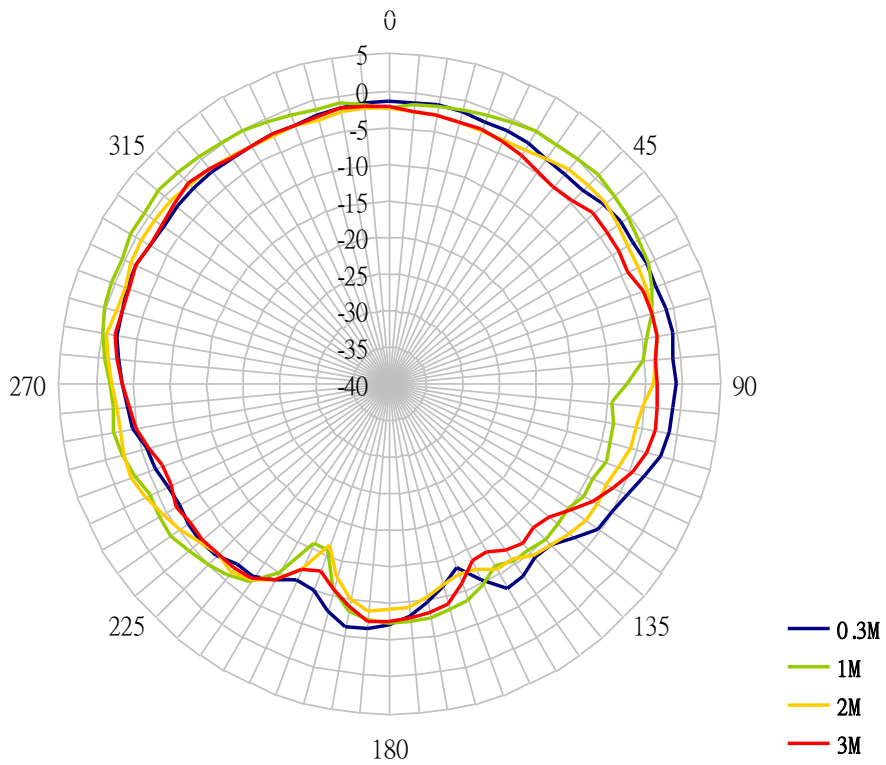

X-Y Plane at 2200MHz

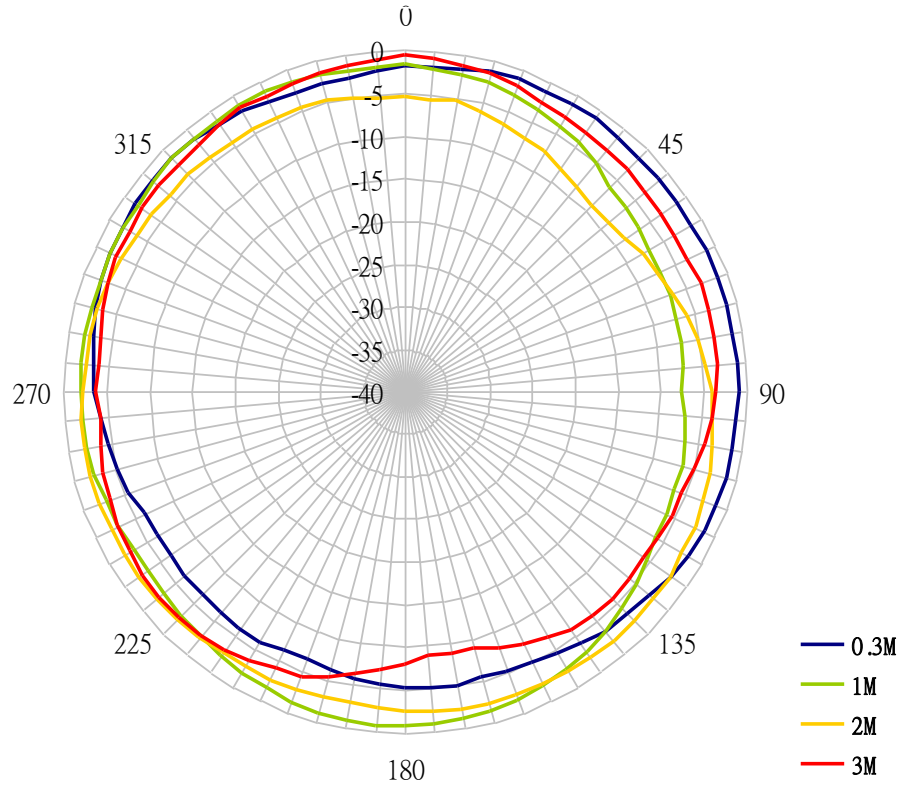

5. 2.4/5GHz Antenna Characteristics

5.1 S11 Return Loss (Free Space)

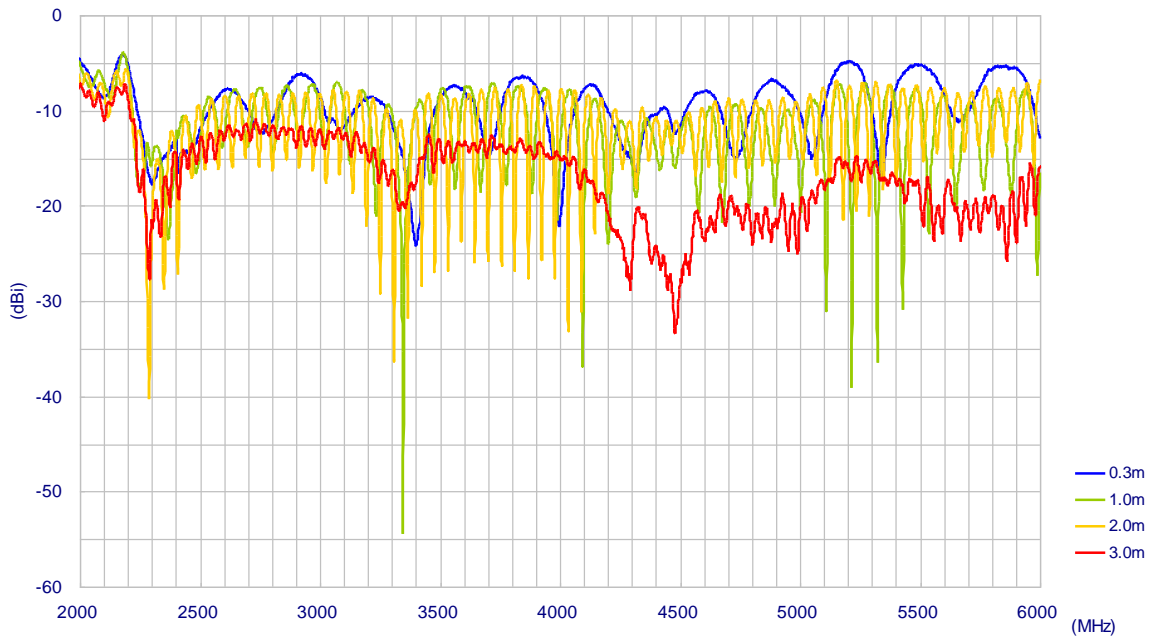

5.2 S11 Return Loss (45cm x 30cm Ground Plane)

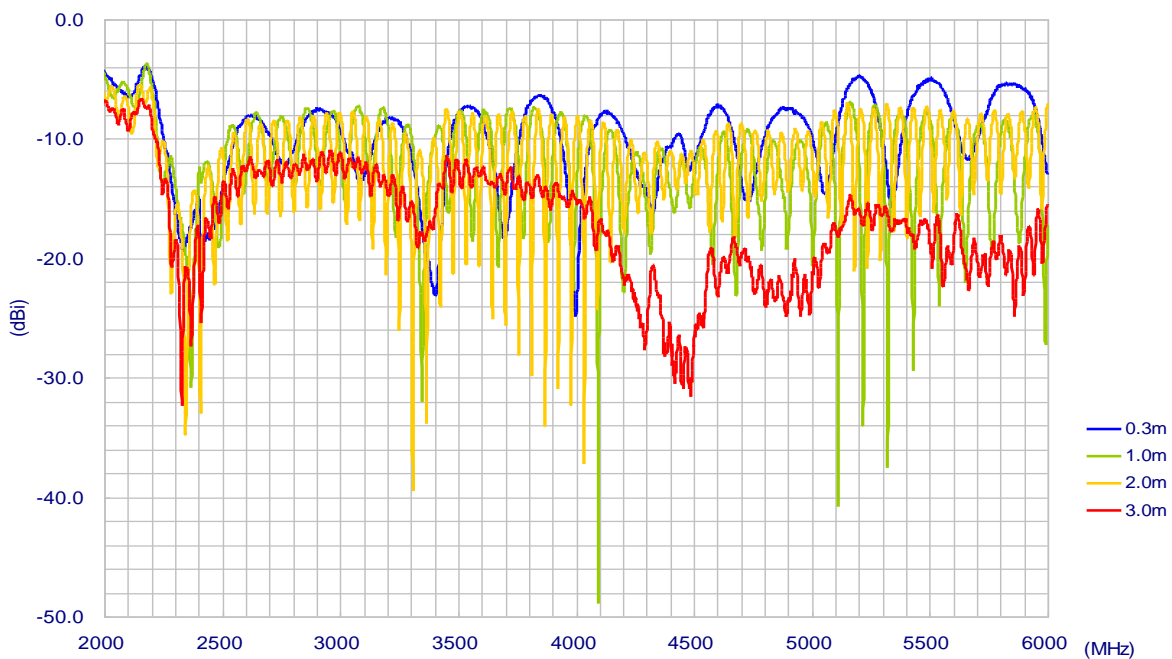

5.3 VSWR (Free Space)

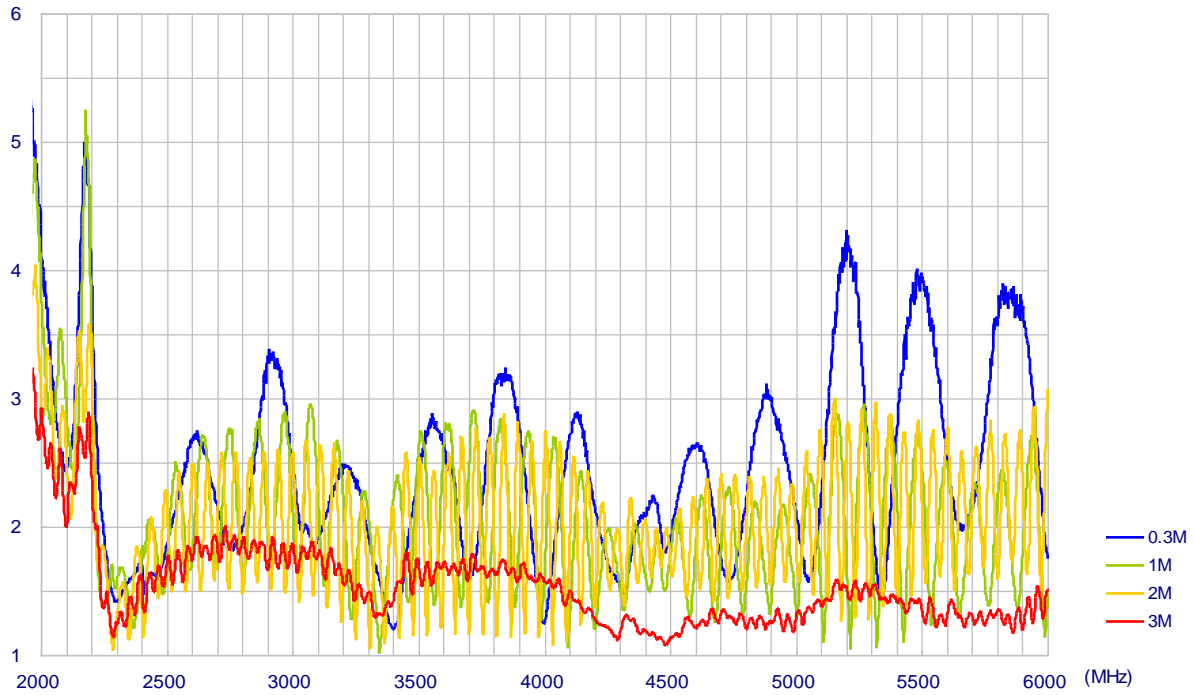

5.4 VSWR (45cm x 30cm Ground Plane)

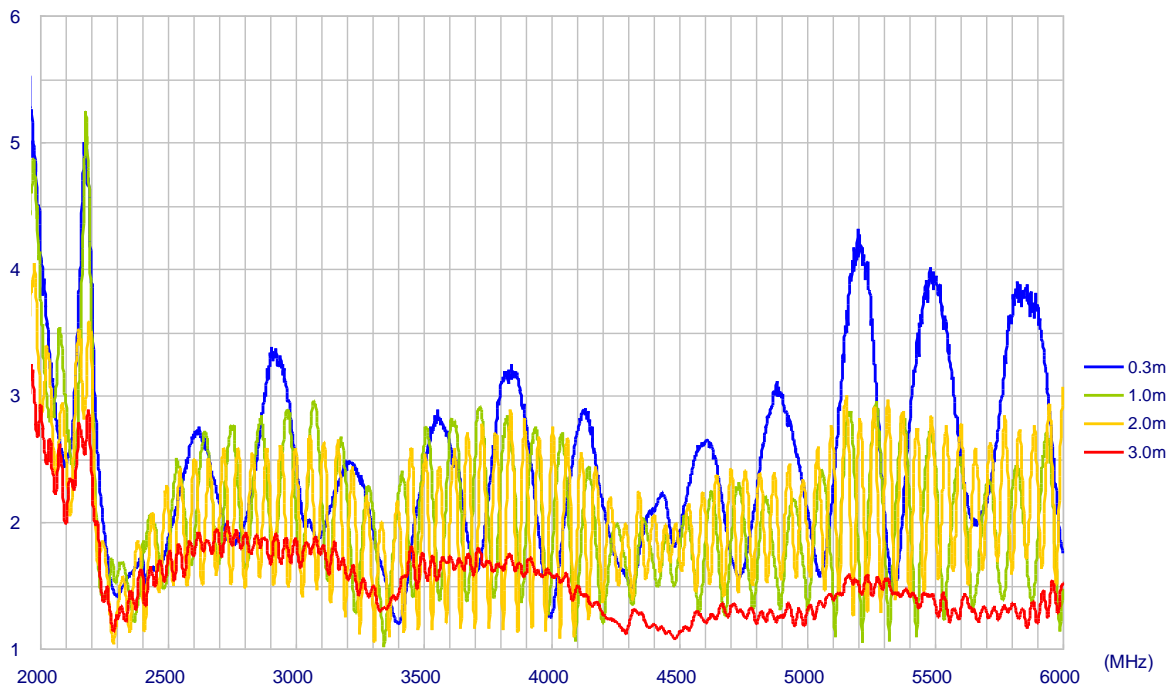

5.5 2.4/5GHz Antenna Free Space Efficiency (3m Cable)

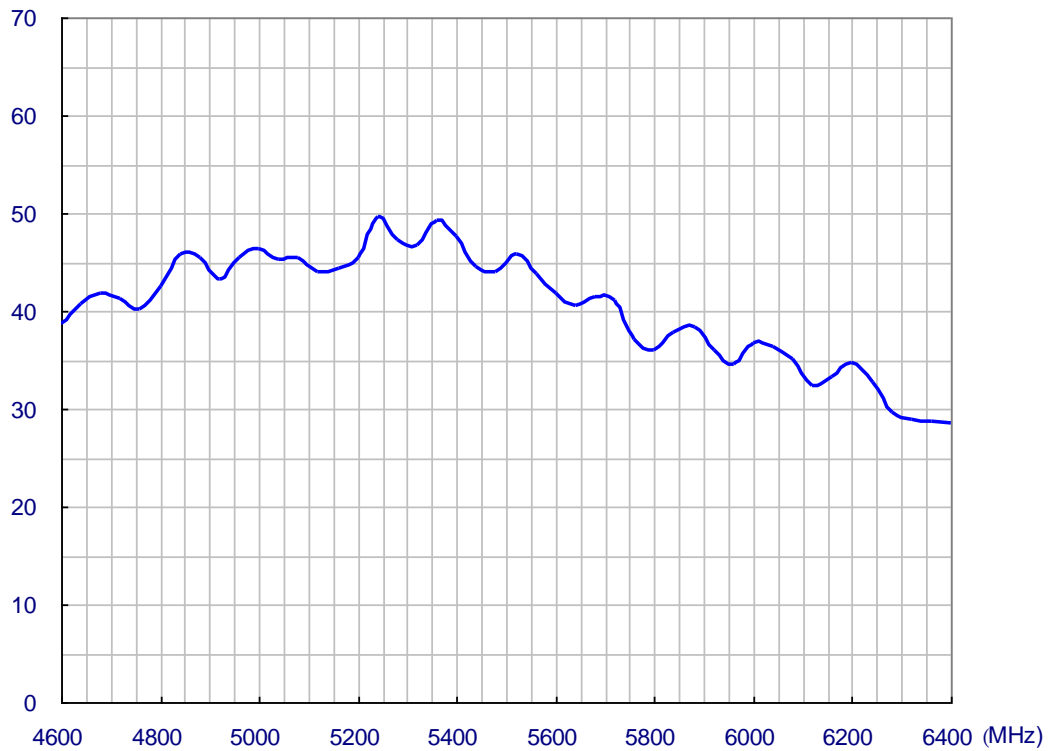
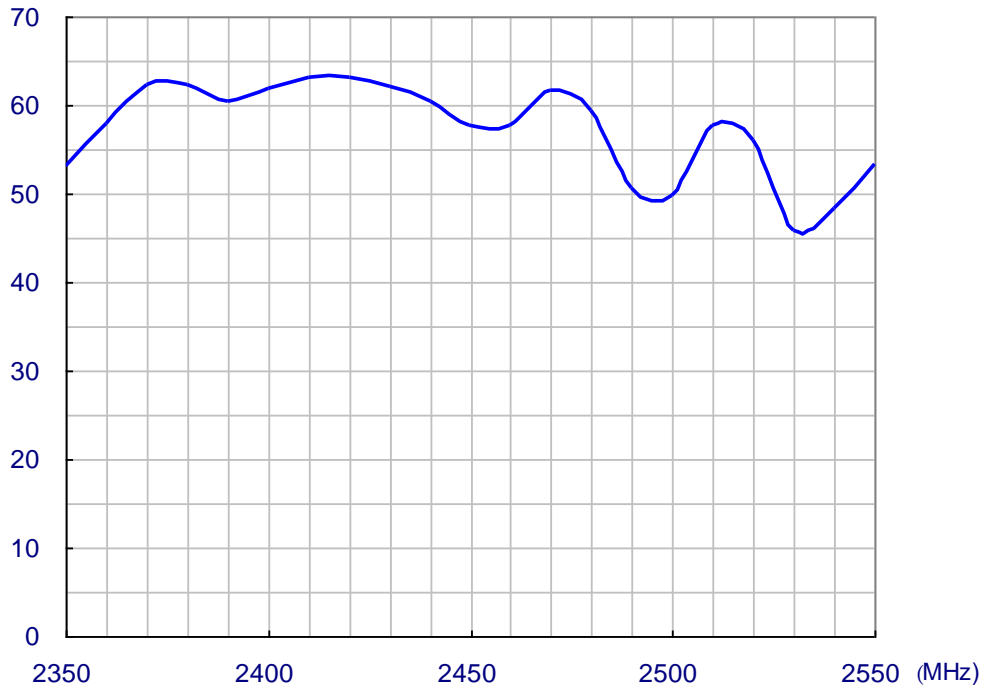

5.6 2.4/5GHz Antenna Free Space Peak Gain (3m Cable)

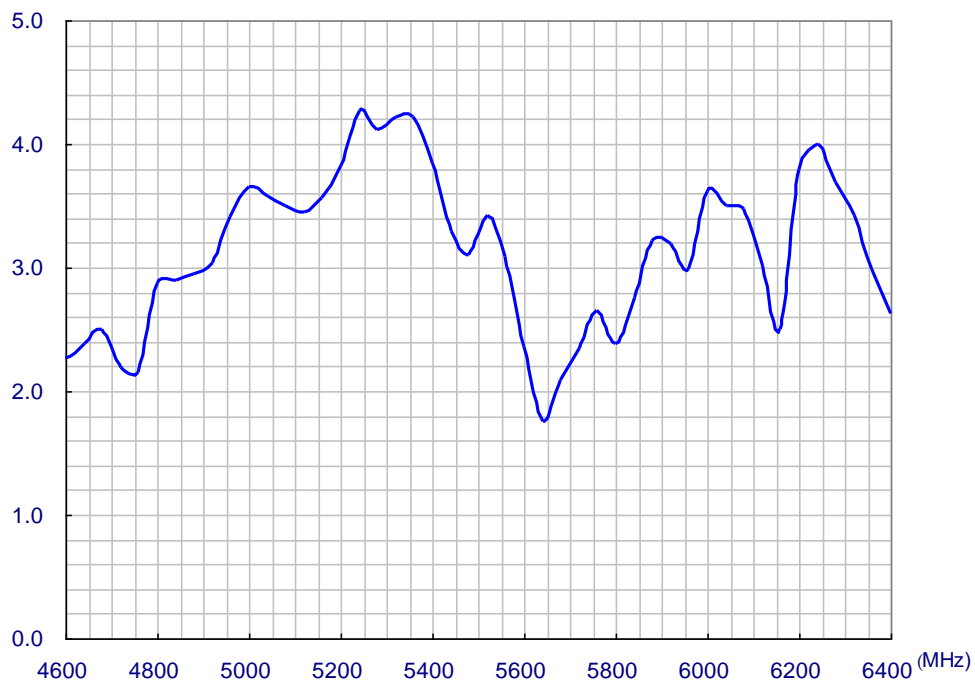
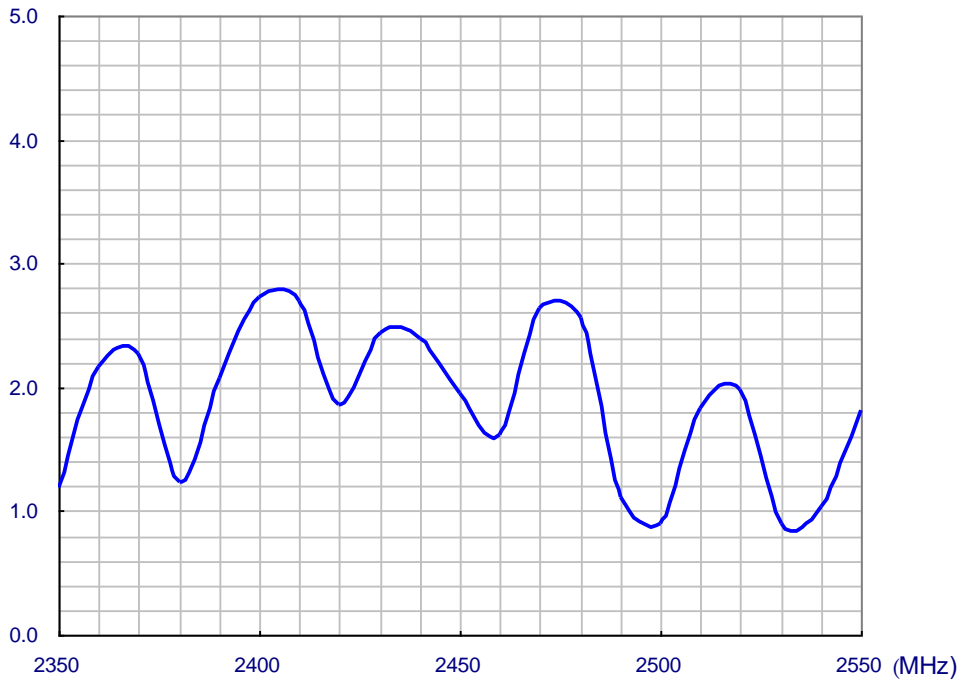

5.7 2.4/5GHz Antenna Free Space 3D Average Gain (3m Cable)

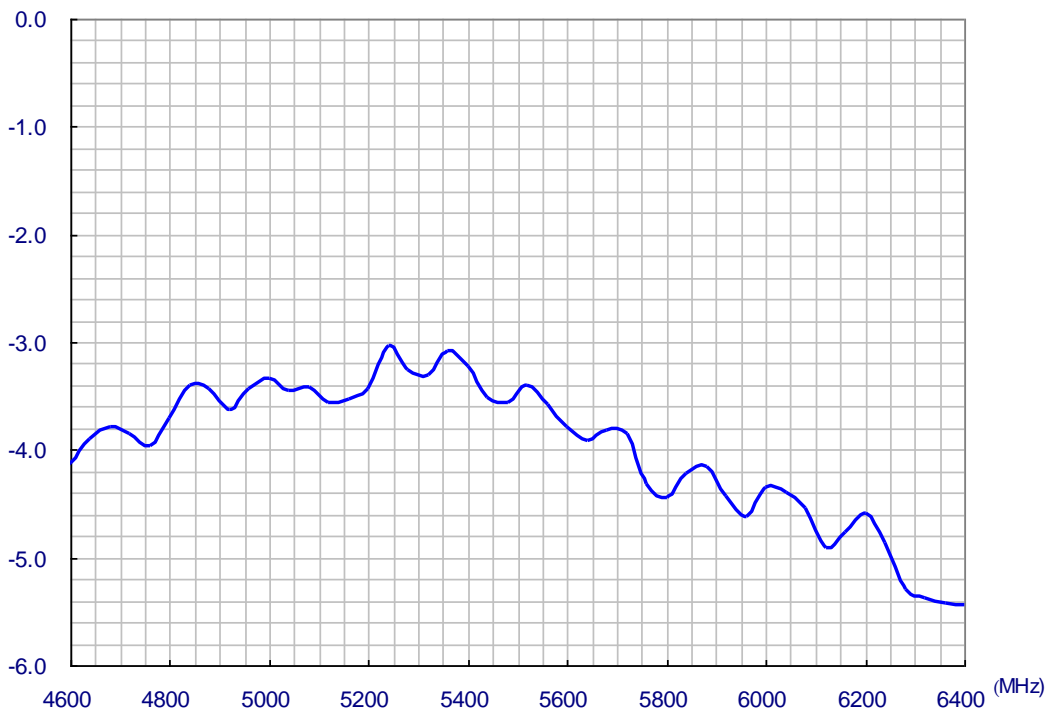
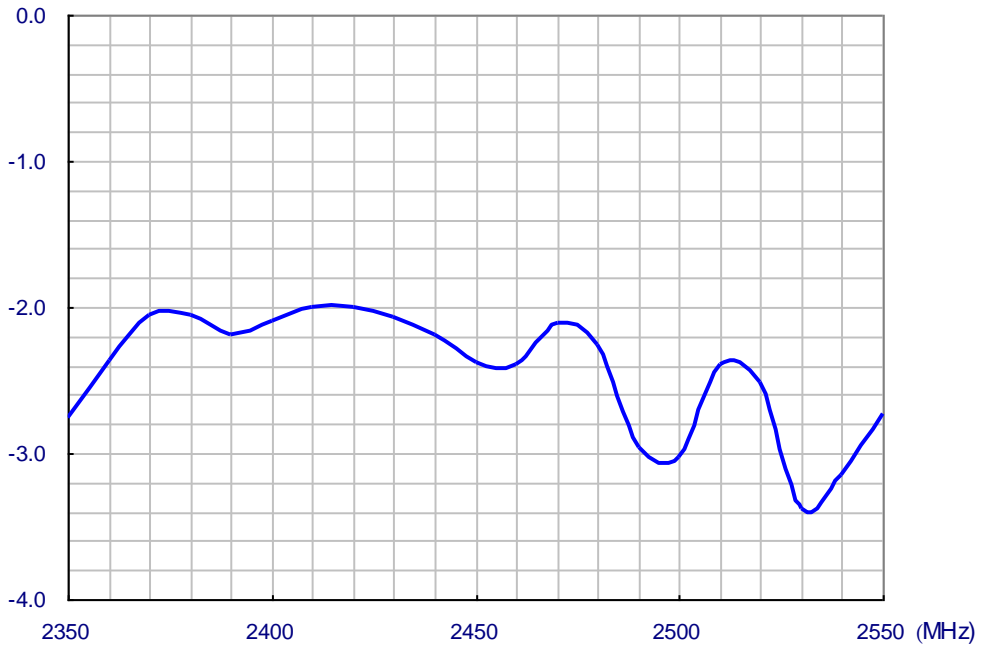

5.8 2.4/5GHz Antenna Free Space Radiation (3m Cable)

X-Y Plane

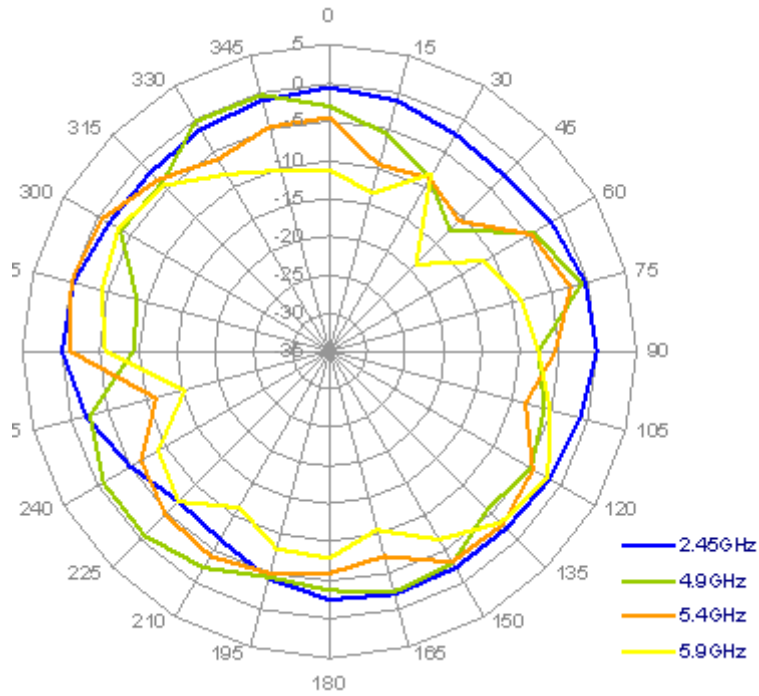

X-Z Plane

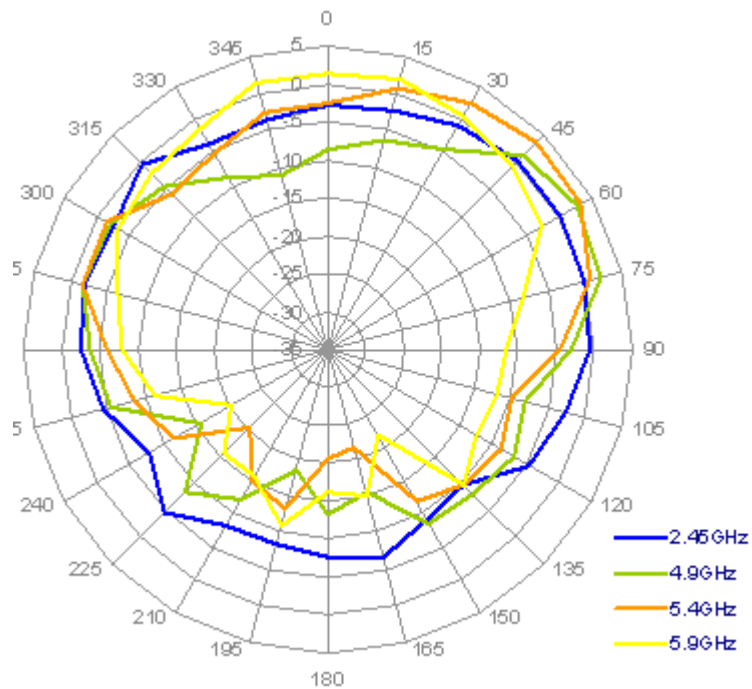

6. Installation

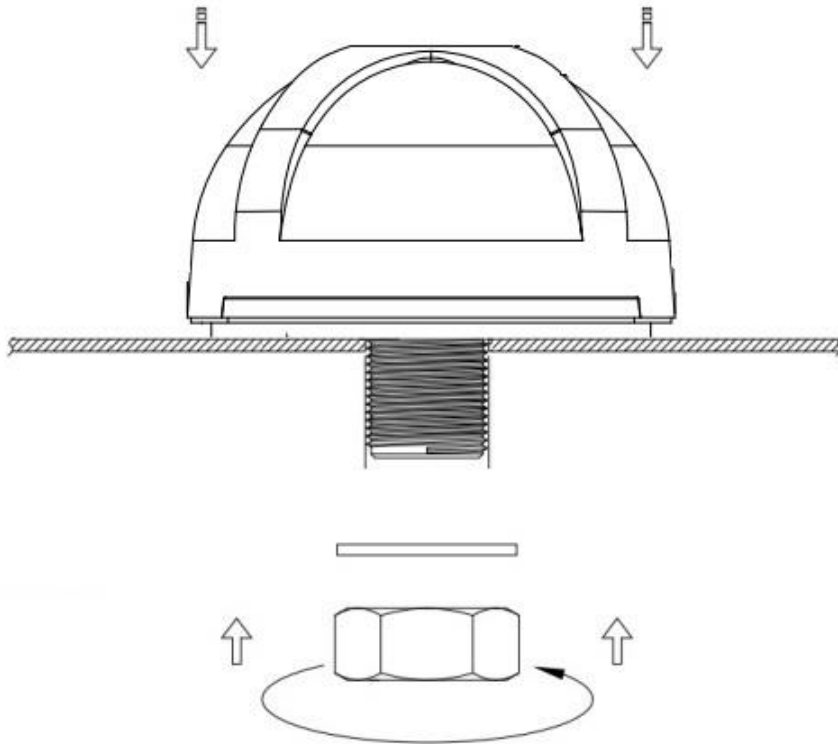

Recommended Torque for Mounting 49 N·m
 Maximum Torque for Mounting 58.8 N·m

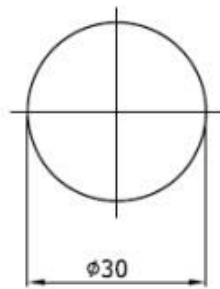

**Thread
 Diameter**

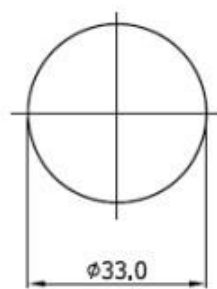

**Recommended
 Mounting Hole**

Unit: mm

7. Mechanical Drawing

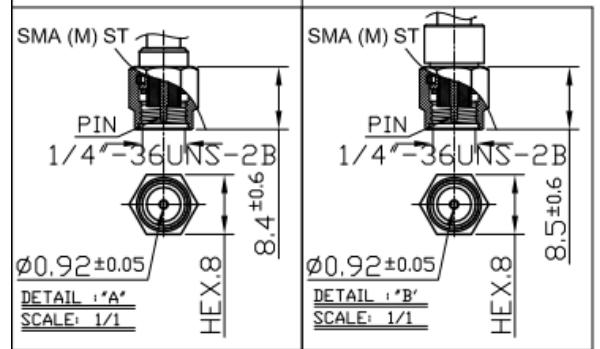
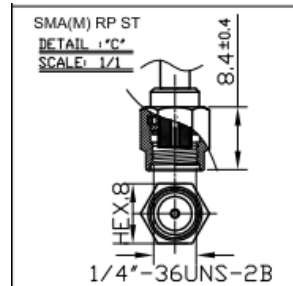
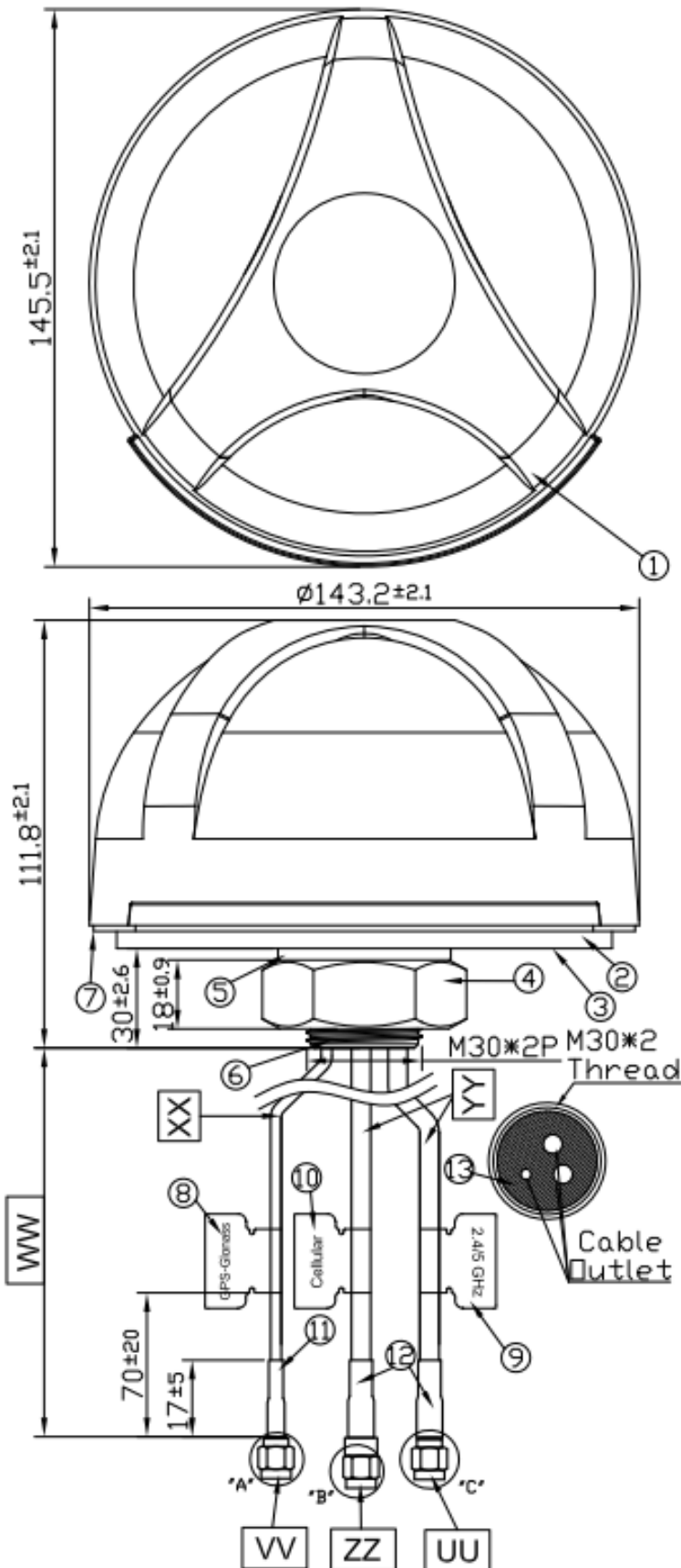

	Name	Material	Finish	QTY
1	Housing	PC 540	Black	1
2	Closed Cell Foam	CR 4305	Black	1
3	3M Double Adhesive	3M 9448 HK	White Liner	1
4	M30 Nut	Steel AISI 1215	Ni Plated	1
5	Washer	Steel AISI 1215	Ni Plated	1
6	M30x 2 Thread 32L	Zinc Alloy	Ni Plated	1
7	Waterproof Gasket	Silicon Rubber	Black	1
8	GPS-Glonass Label	Coated Paper	Orange	1
9	2.4GHz/5 GHz Label	Coated Paper	Green	1
10	Cellular Label	Coated Paper	Blue	1
11	Heat Shrink Tube	PE(RG174)	Black	1
12	Heat Shrink Tube	PE(CFD200)	Black	2
13	Rubber Stopper	Silicone Rubber	Black	1

	Name	Spec	Finish	QTY
VV	Connector Type	SMA(M) ST	Gold	1
UU	Connector Type	SMA(M)RP ST	Gold	1
WW	Cable Length	3000 \pm 120mm		3
XX	Cable Type	RG174	Black	1
YY	Cable Type	CFD 200	Black	2
ZZ	Connector Type	SMA(M) ST	Gold	1

8.Packaging

BOX

REV	DATE	DESCRIPTION
A	2011/03/11	New issue

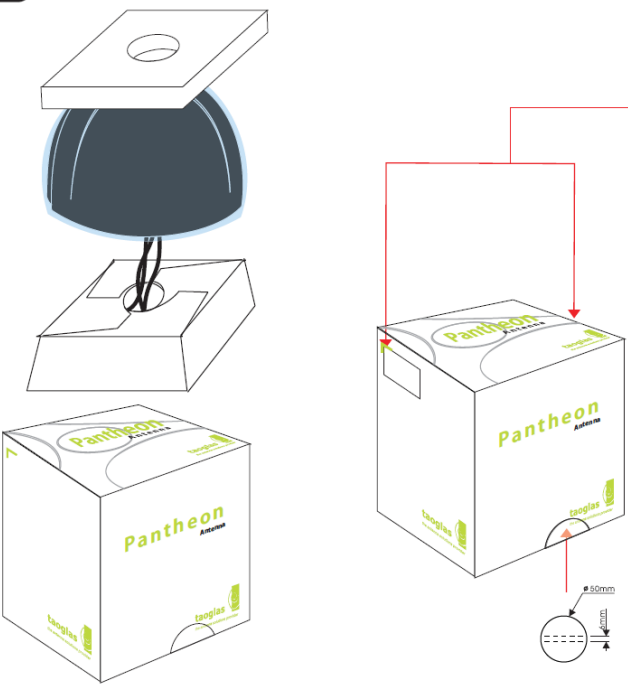

50mm

20mm

C1049-570069-A P/N

3310-0001

706-0000689-AR

code 39

3310-0001

Serial Number

YY

WW

50mm

Carton

REV	DATE	DESCRIPTION
A	2011/03/11	New issue

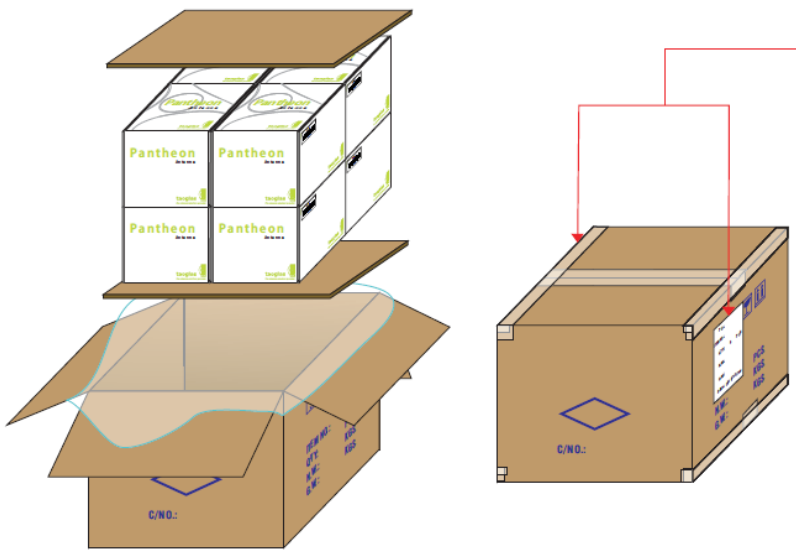

P.O.:

ITEM NO.:

QTY: 8 PCS

N.W.:

G.W.:

DIMs: 362 x 345 x 290 mm

153 mm

103 mm