

35

3554

RAST 2.5 connectors, pitch 2.5/5.0 mm

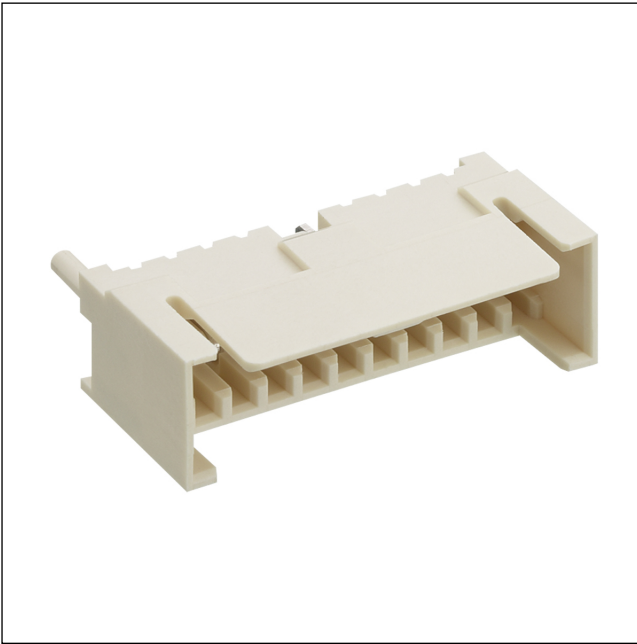

RAST 2.5 pin header, angular, with locking latch
contact pitch 2.5 mm

State: Active

Approvals:



35

3554

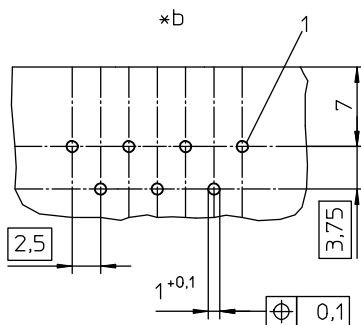
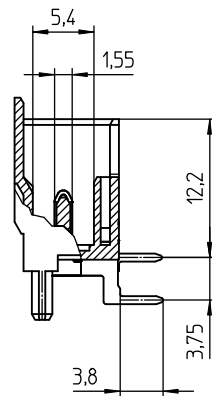
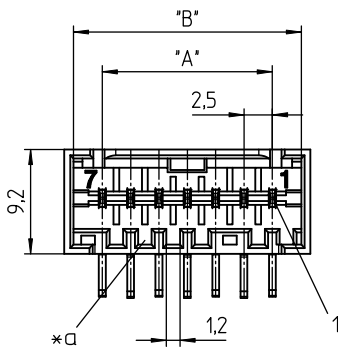
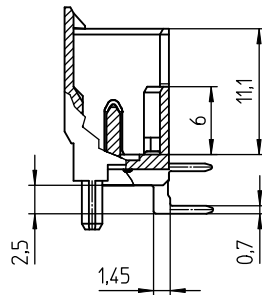
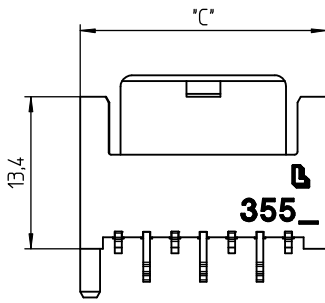

*C

Environmental conditions

Temperature range -40 °C/+120 °C¹

¹ upper limit temperature (insulating body) RTI (electrical) of the UL Yellow Card

Materials

Insulating body

PA GF, V-0 according to UL94¹

Contact pin

CuZn, pre-nickel and tin-plated

¹ M12: component glow wire resistant (GWT 750 °C), testing acc. to IEC 60695-2-11, assessment acc. to IEC 60335-1 (flame < 2 s)

Mechanical data

Keying proposals

at www.lumberg.com 

Electrical data (at T_{amb} 20 °C)

Rated current

4 A (T_u 60 °C)
2 A (T_u 100 °C)

Rated voltage

32 V AC

Material group

IIIa (IEC)/2 (UL) (CTI ≥ 250)

Creepage distance

1,9 mm

Clearance

1,9 mm

Insulation resistance

> 1 GΩ

Associated products

Counterparts

 3521

 3521-2

 352100

35

3554

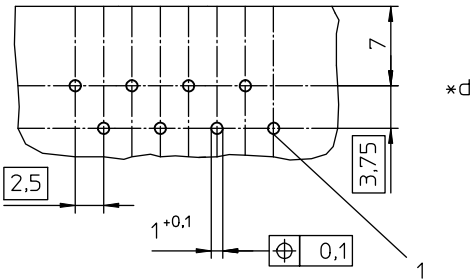

- *a keying
- *b printed circuit board layouts, solder side view
- *c uneven pole numbers
- *d even pole numbers

Designation	Pole Number	PU (Pieces)	MDQ (Pieces)	Dimensions		
				A (mm)	B (mm)	C (mm)
3554 02	2	1000	2000	2.5	7.6	9.2
3554 03	3	1000	2000	5.0	10.1	11.7
3554 04	4	1000	2000	7.5	12.6	14.2
3554 05	5	1000	2000	10.0	15.1	16.7
3554 06	6	500	2000	12.5	17.6	19.2
3554 07	7	500	2000	15.0	20.1	21.7
3554 08	8	500	2000	17.5	22.6	24.2
3554 09	9	500	2000	20.0	25.1	26.7
3554 10	10	500	2000	22.5	27.6	29.2
3554 11	11	250	2000	25.0	30.1	31.7
3554 12	12	250	2000	27.5	32.6	34.2
3554 13	13	250	2000	30.0	35.1	36.7
3554 14	14	250	2000	32.5	37.6	39.2
3554 15	15	250	2000	35.0	40.1	41.7
3554 16	16	250	2000	37.5	42.6	44.2
3554 17	17	250	2000	40.0	45.1	46.7
3554 18	18	250	2000	42.5	47.6	49.2
3554 19	19	250	2000	45.0	50.1	51.7
3554 20	20	250	2000	47.5	52.6	54.2

Designation to be completed by further details (e.g. for keying, color or material options).

Packaging:

in bulk, in a cardboard box