

SPECIFICATION

PATENTED

Part No. : **TG.30.8111 Apex**

Product Name : Apex Black Straight TG.30
Ultra-Wideband 4G LTE Antenna

Feature : LTE / GSM / CDMA /DCS /PCS / WCDMA / UMTS /
HSDPA / GPRS / EDGE /GPS /Wi-Fi
698MHz to 960MHz, 1575.42MHz,
1710MHz to 2700Mhz
Patented
Typical 70%+ Efficiency and 3dBi+ Peak Gain
Dipole Swivel Terminal Antenna
Straight SMA(M) Connector
RoHS Compliant



1. Introduction

The Apex Black Straight TG.30 Dipole LTE Antenna – is primarily designed for use with 4G LTE modules and devices that require the highest possible efficiency and peak gain to deliver best in class throughput on all major cellular (2g/3g/4g) bands worldwide for access points, terminals and routers. The antenna is a ground plane independent antenna with a SMA (M) connector and swivel mechanism that allows the antenna part to be rotated around the connector. The Apex exhibits high efficiency across the ultra wide band and is backward compatible with 2G and 3G cellular applications such as GSM, LTE, UMTS, Wi-Fi and even has GPS included for Assisted GPS and/or E911 applications. With very high efficiency on every cellular band globally it is an ideal solution for any device requiring high, reliable performance. It is also guaranteed to meet any type approval or carrier certification requirements from a RF standpoint. It is an omni-directional antenna and the radiation patterns display this and are stable across all bands.

It has a quality robust IP67 UV resistant housing (SMA connector is IP65) for use with wireless terminals. The swivel mechanism allows the antenna part itself to be orientated in different directions and can help avoid touching off other antennas or objects close by as well as helping with isolation by orientating the antenna in different directions in MIMO systems or when other TG.30 antennas are present on the same device.

This patented antenna is available in White and Black versions. It is also available with Hinged and Right Angle connectors.

2. Specification

ELECTRICAL							
Frequency (MHz)	700~800	824~960	1575.42	1710 ~ 1880	1850 ~ 1990	1710 ~ 2170	2400~2700
Peak Gain (dBi)							
Free Space	2.0	1.2	0.3	2.4	3.0	3.0	4.2
30x30cm GP	3.0	1.5	2.9	3.7	3.6	3.7	6.5
Average Gain							
Free Space	-0.7	-1.1	-1.7	-0.2	-0.5	-0.2	-0.7
30x30cm GP	-0.3	-1.0	-1.2	-0.4	-0.6	-0.4	-0.4
Efficiency							
Free Space	86%	78%	67%	82%	89%	55%	60%
30x30cm GP	90%	68%	75%	82%	86%	70%	72%
Impedance	50Ω						
Polarization	Linear						
Radiation Pattern	Omni						
Input Power	10 W						
MECHANICAL							
Casing	UV Resistant, PC/ABS						
Connector	SMA Male						
ENVIRONMENTAL							
Temperature Range	-40°C to 85°C						
Humidity	Non-condensing 65°C 95% RH						

3. Antenna Characteristics

3.1 Return Loss

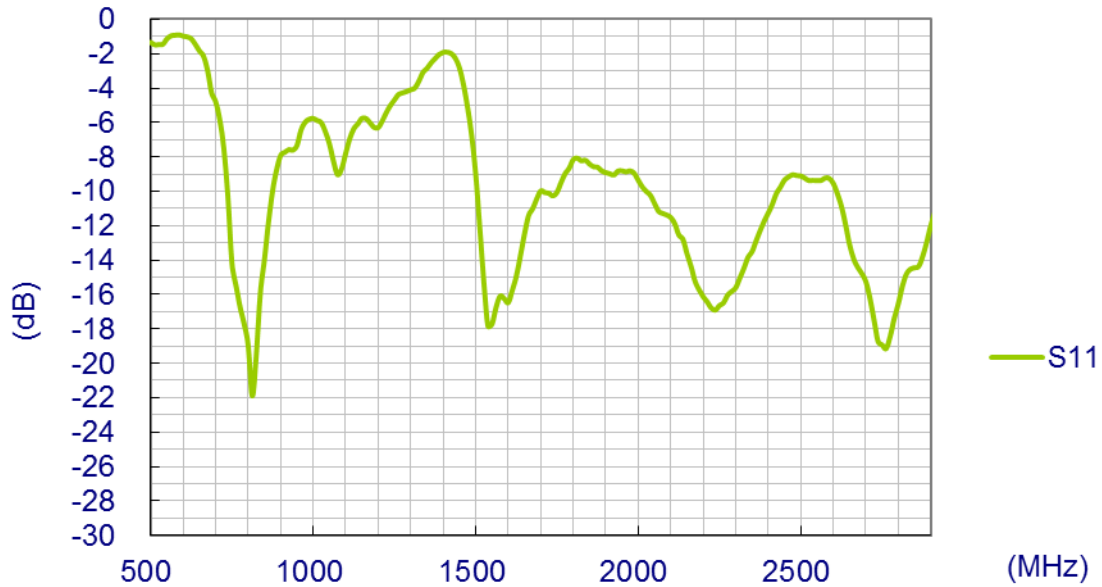

3.2 Peak Gain

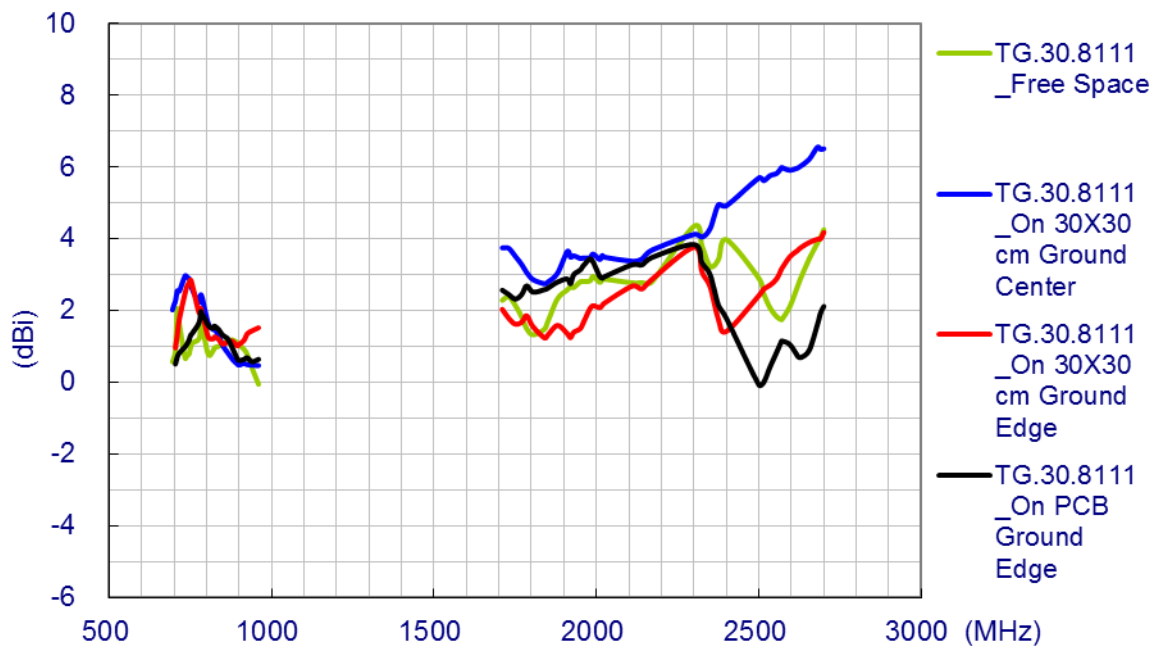

3.3 Average Gain

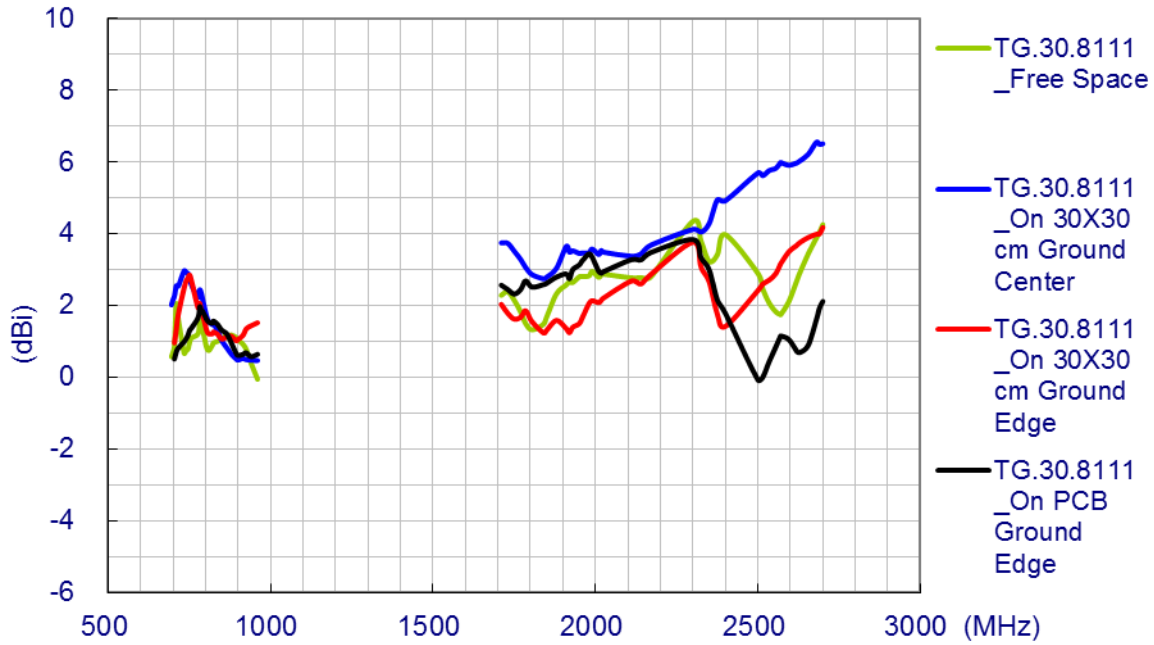

3.4 Efficiency

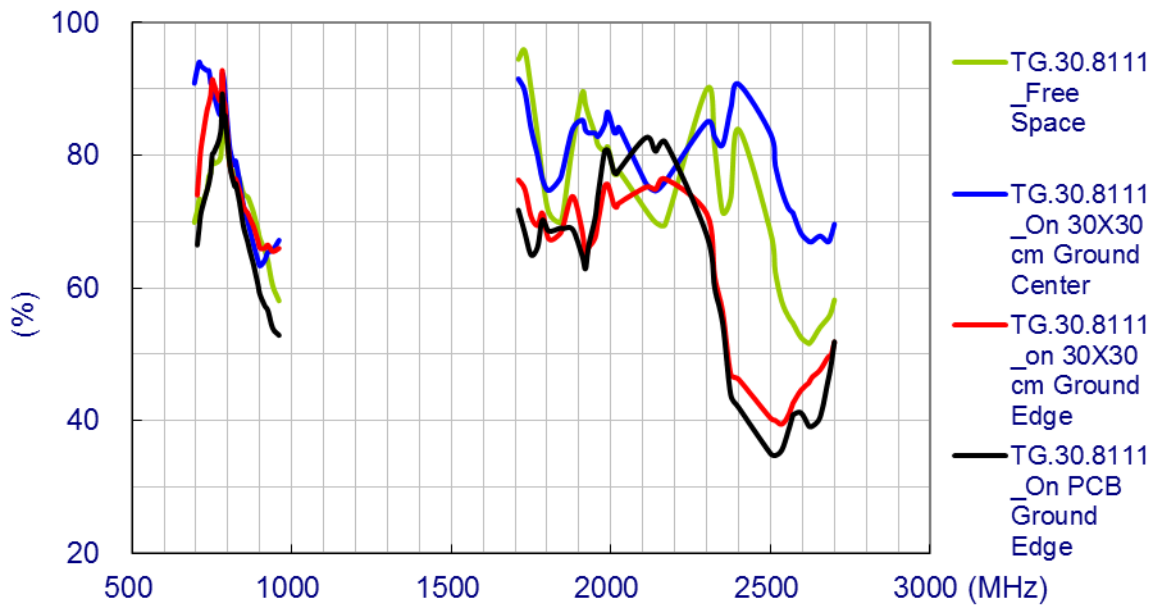

4. Antenna Radiation Patterns

4.1 Antenna setup (Free Space)

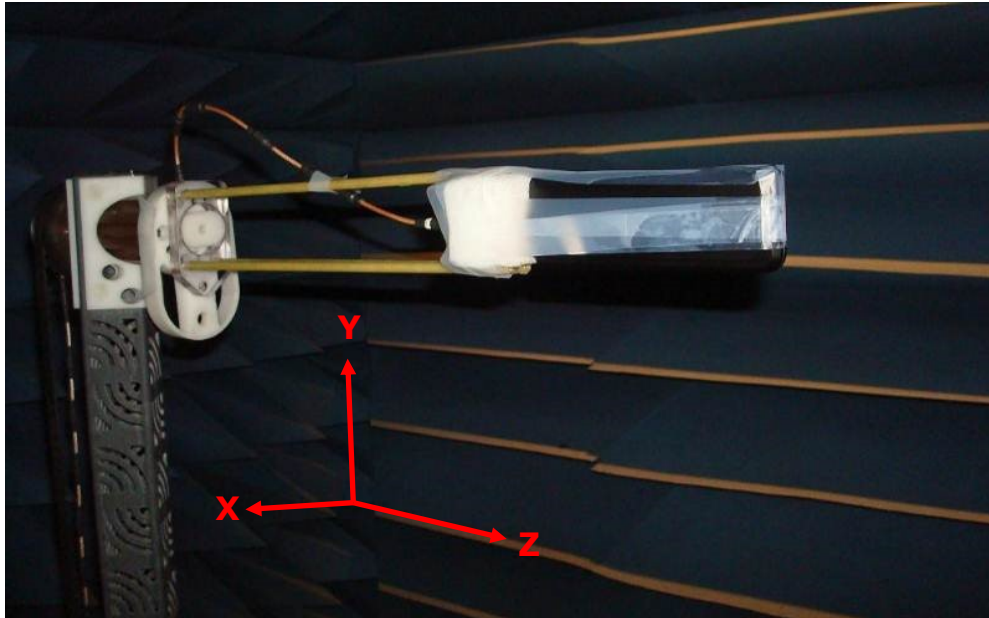

4.2 Radiation Patterns (Free Space)

XY Plane

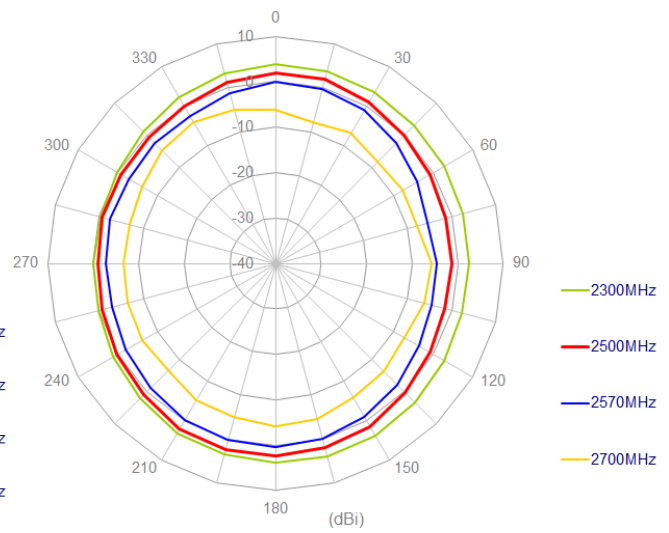
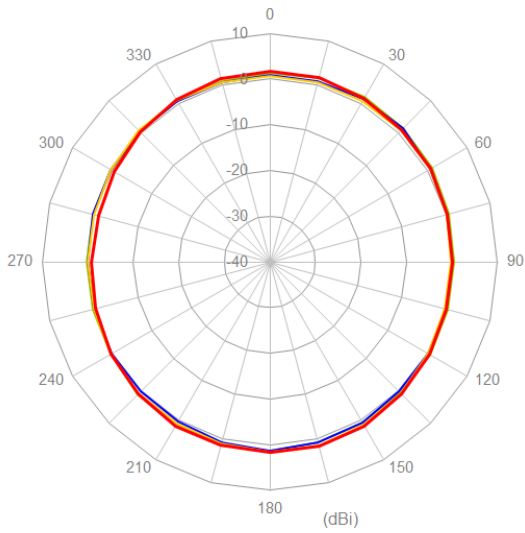
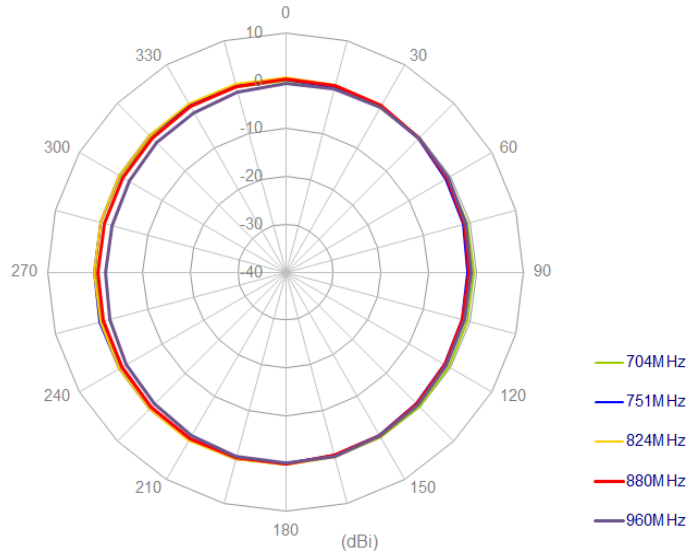

XZ Plane

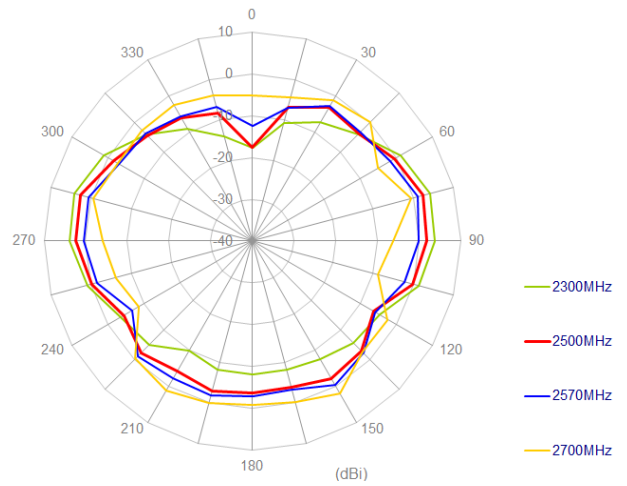
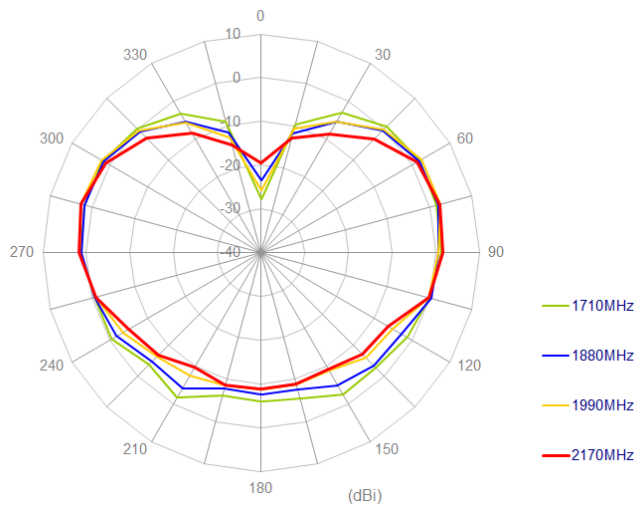
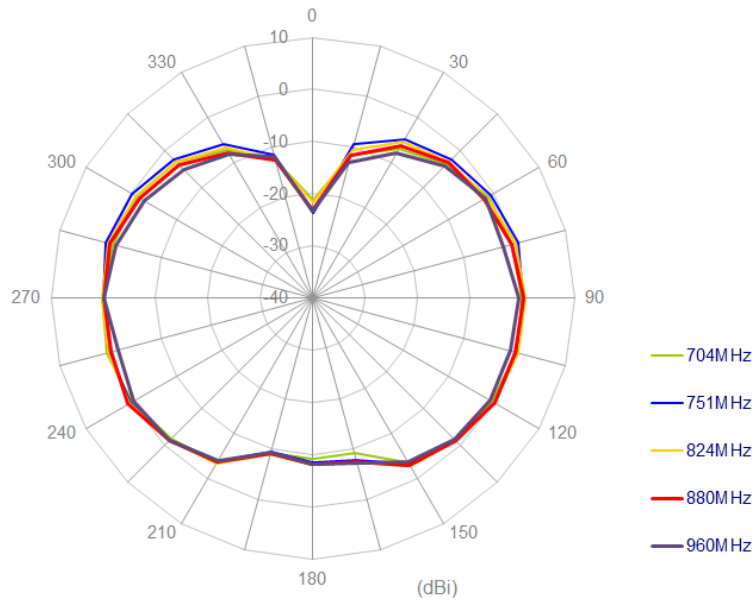

4.3 Antenna setup (On 300x300mm ground center)

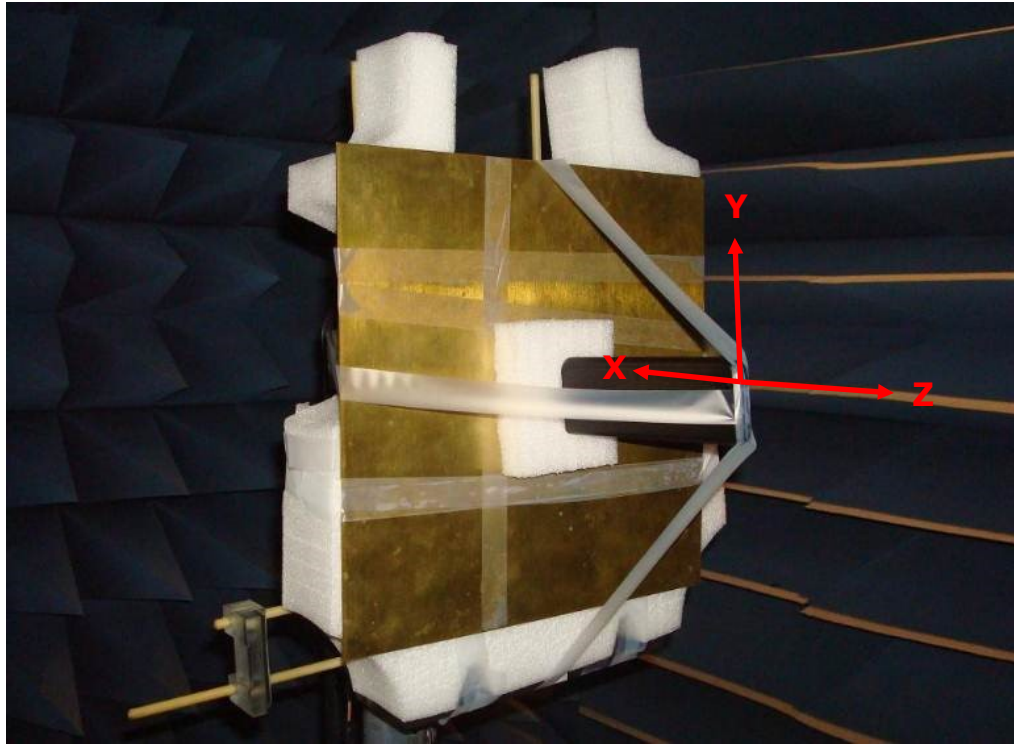

4.4 Radiation Patterns (On 300x300mm ground center)

XY plane

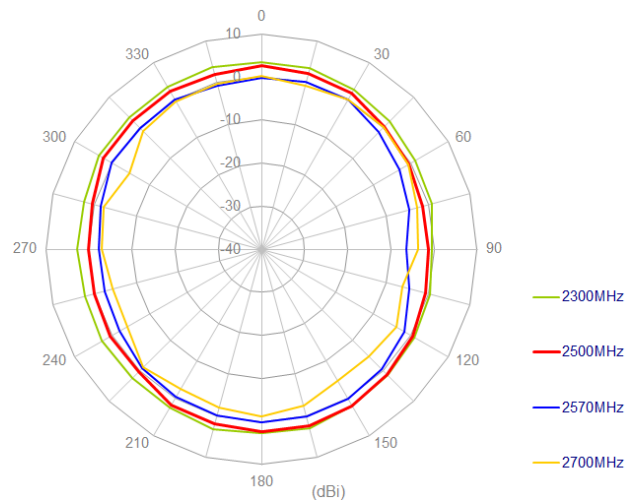
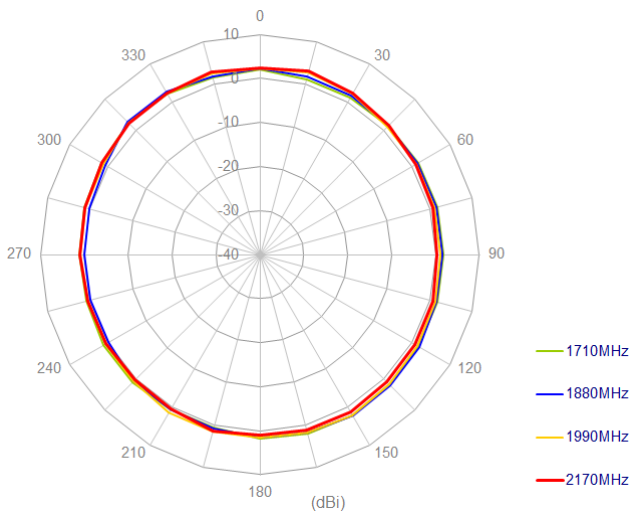
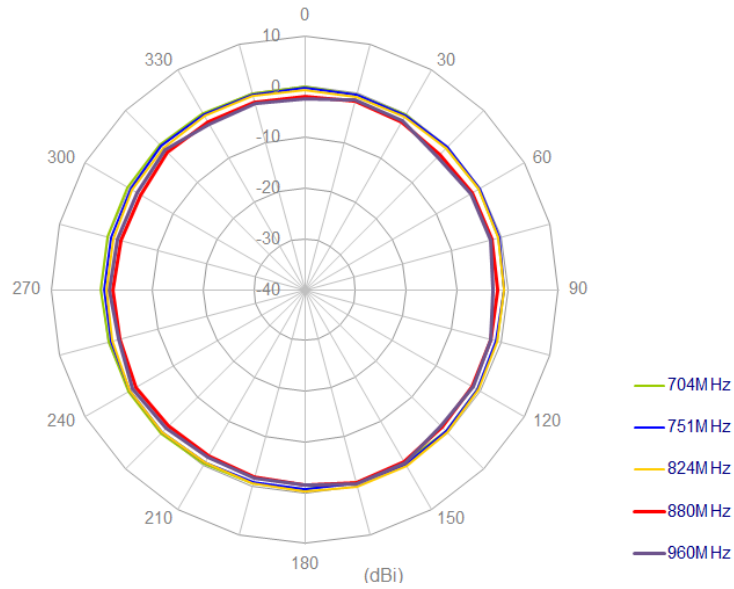

XZ Plane

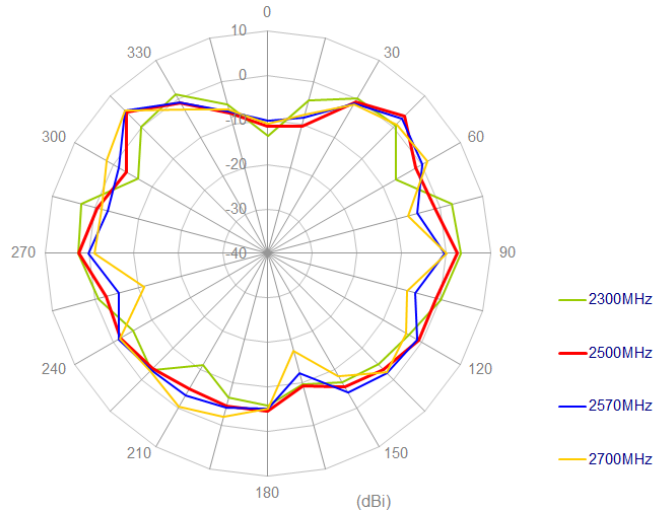
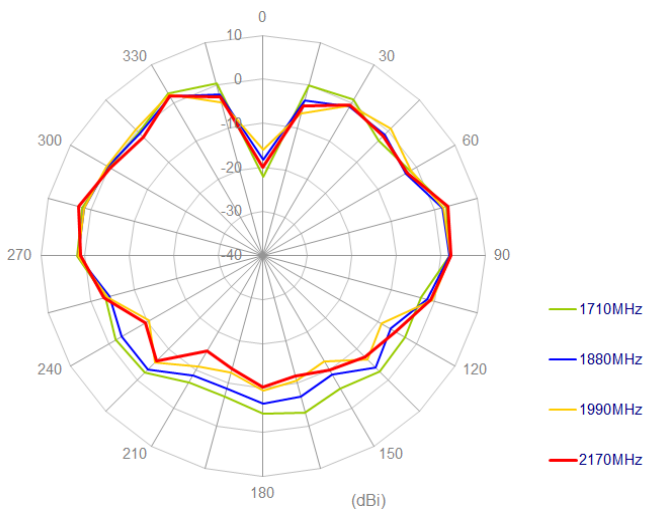
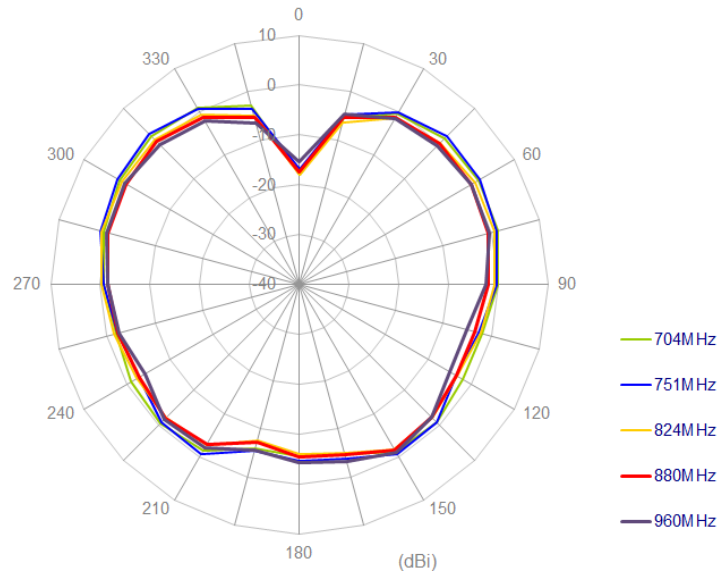

4.5 Antenna setup (On 300x300mm ground edge)

4.6

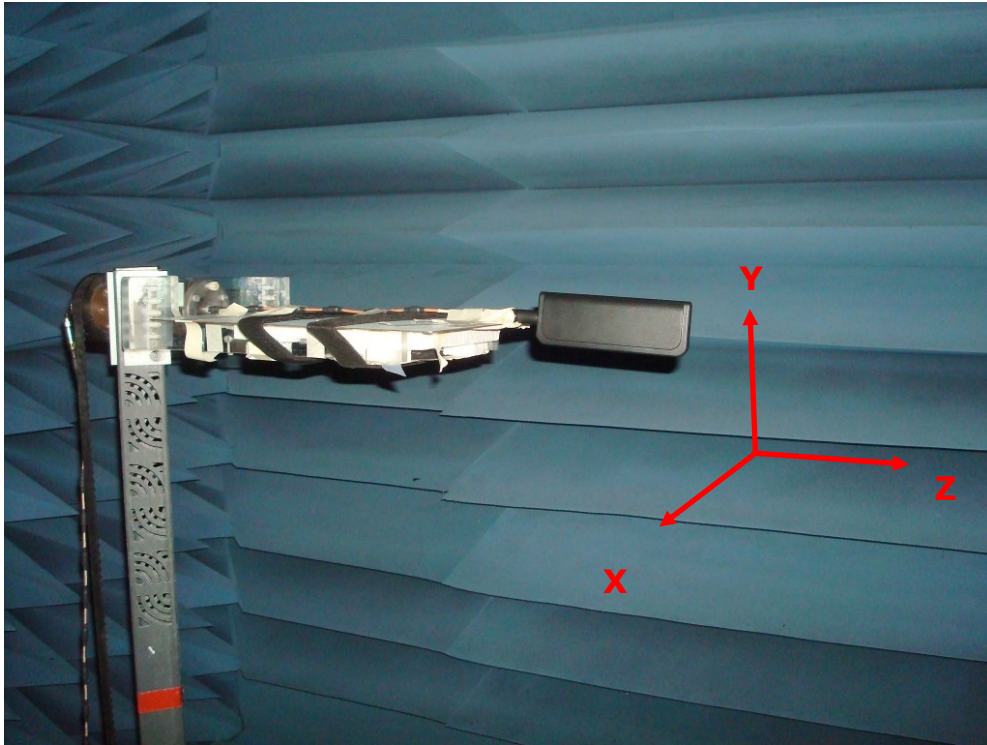

4.7 Radiation Patterns (On 300x300mm ground edge)

XY Plane

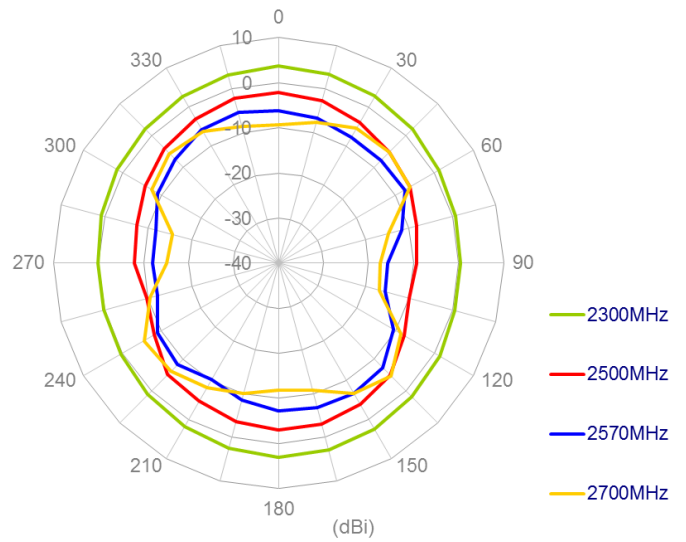
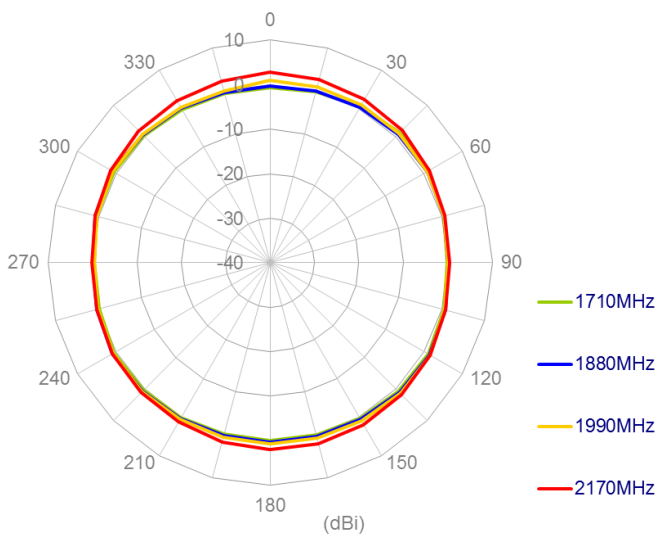
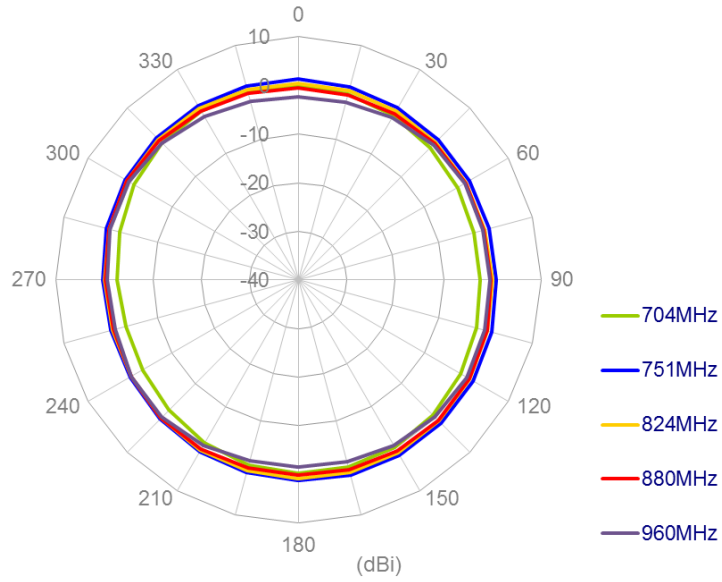

XZ Plane

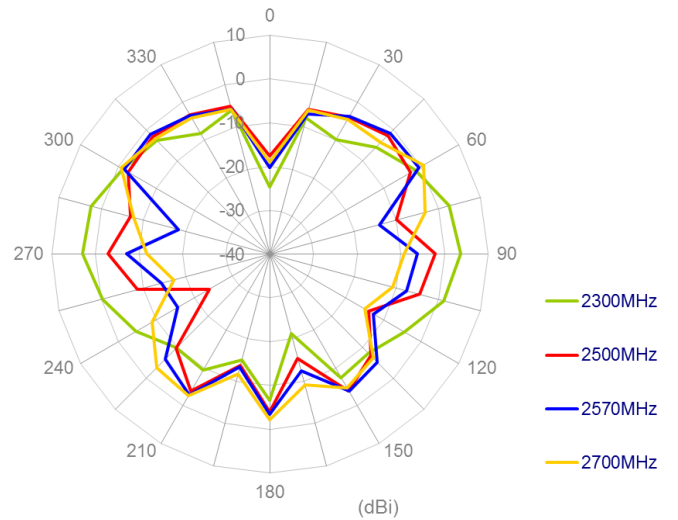
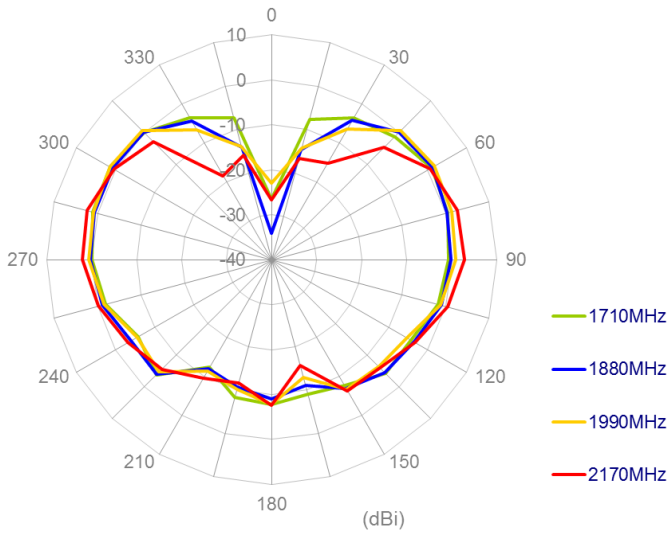
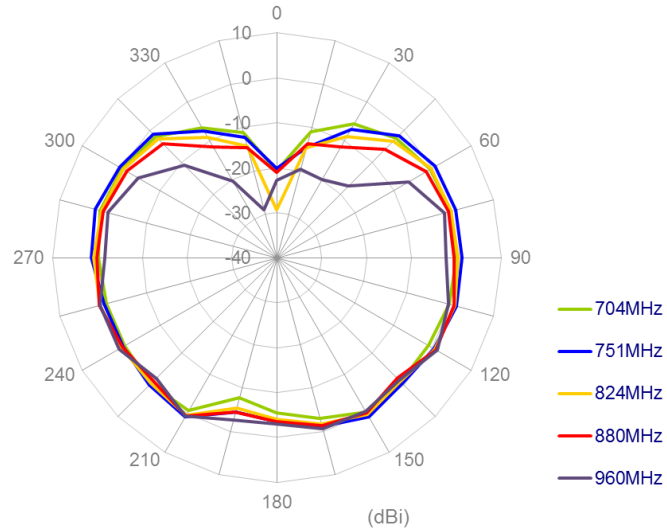

4.8 Antenna setup (On ground edge)

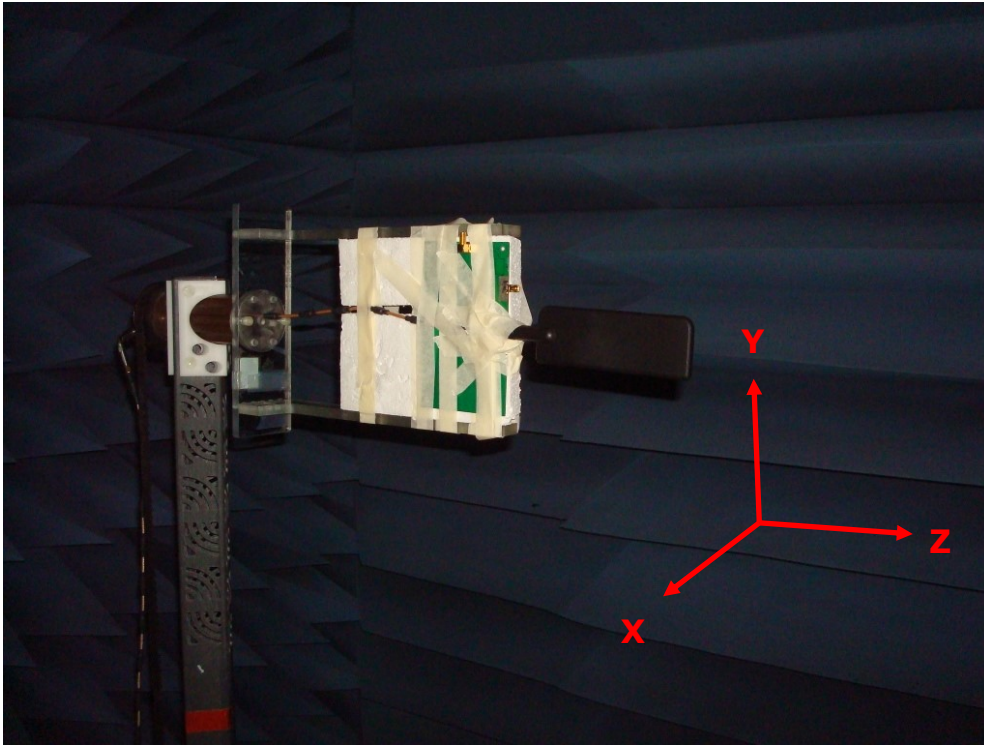

4.9 Radiation Patterns (On ground edge)

XY Plane

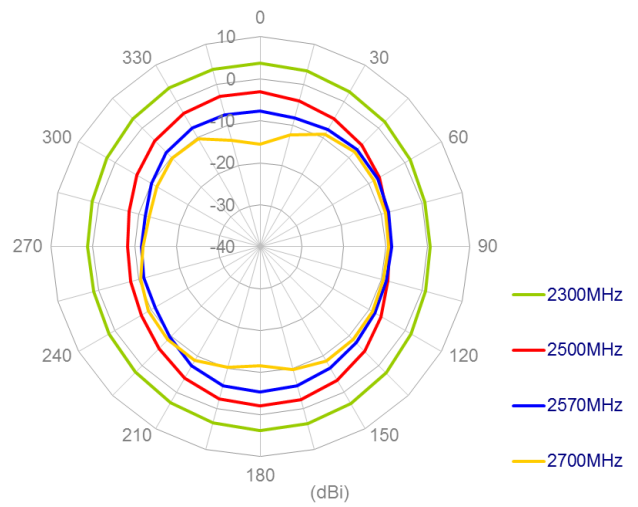
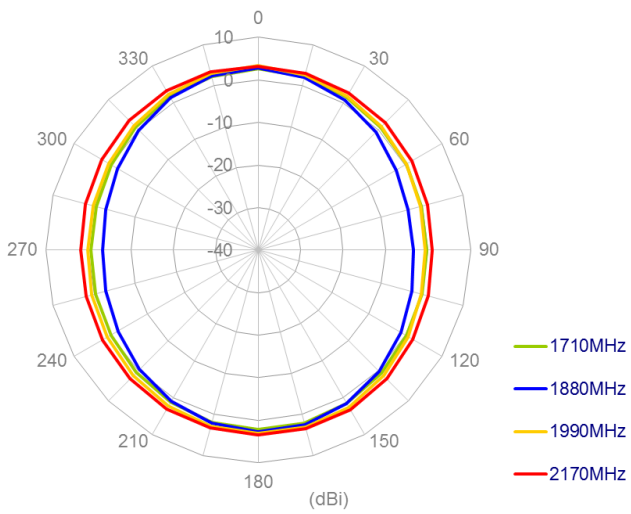
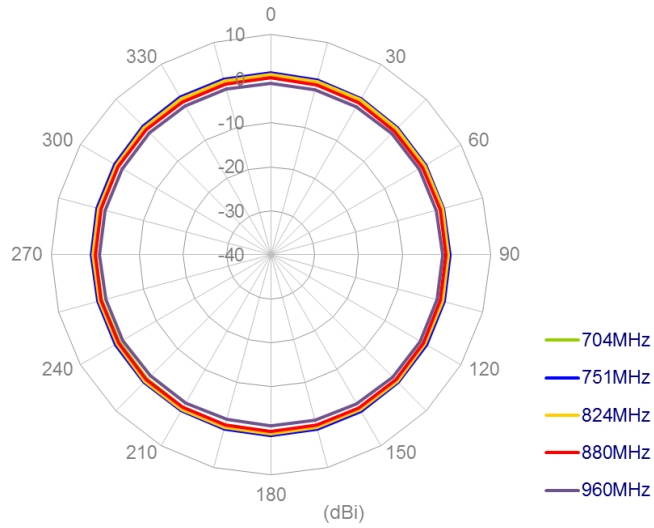

XY Plane

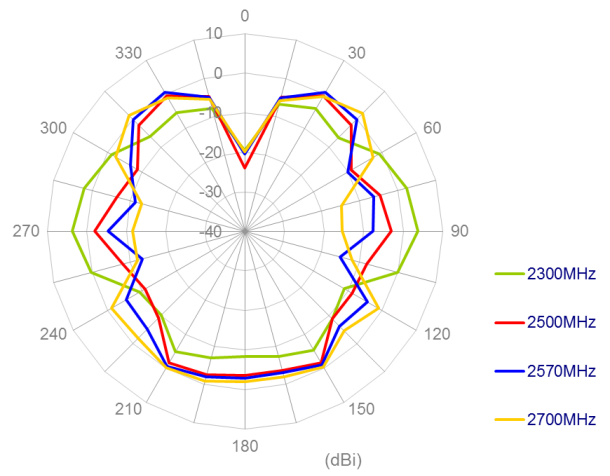
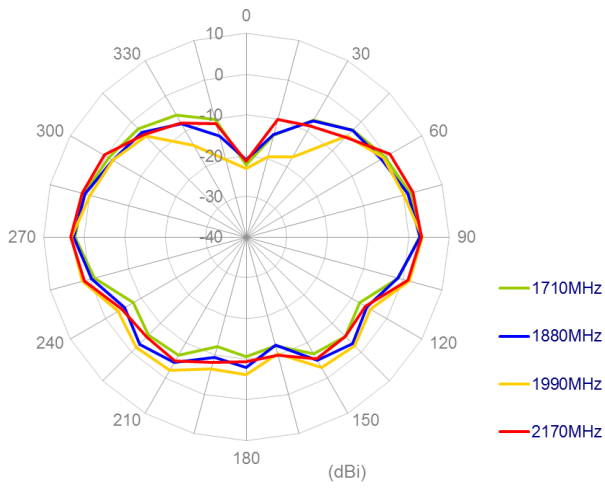
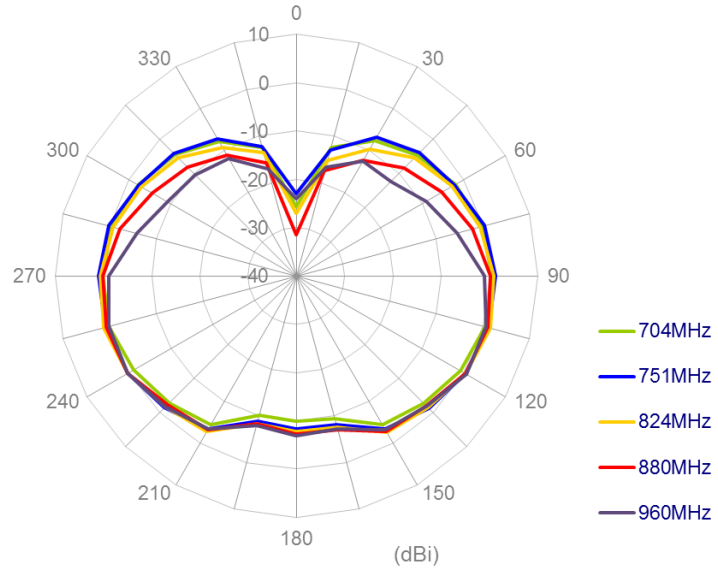

5 Drawing (Unit: mm)

Front View

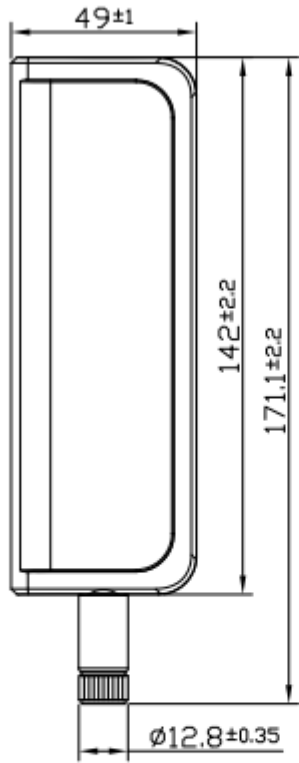

Side View

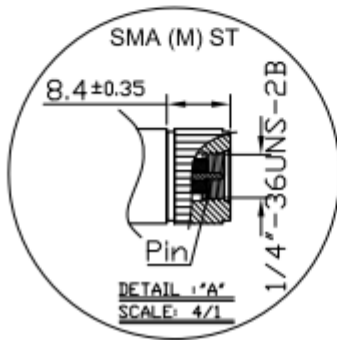
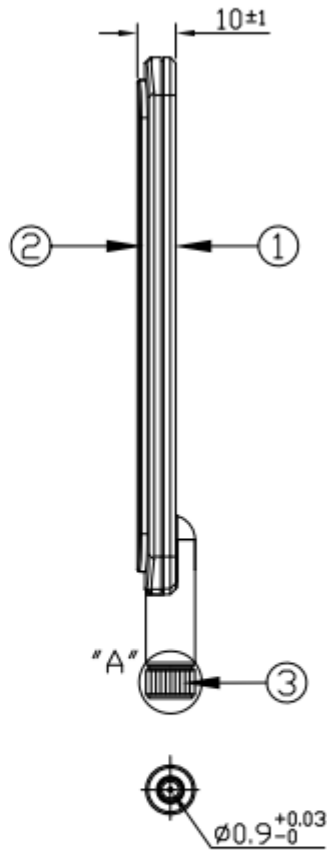

6 Packaging (Unit: mm)

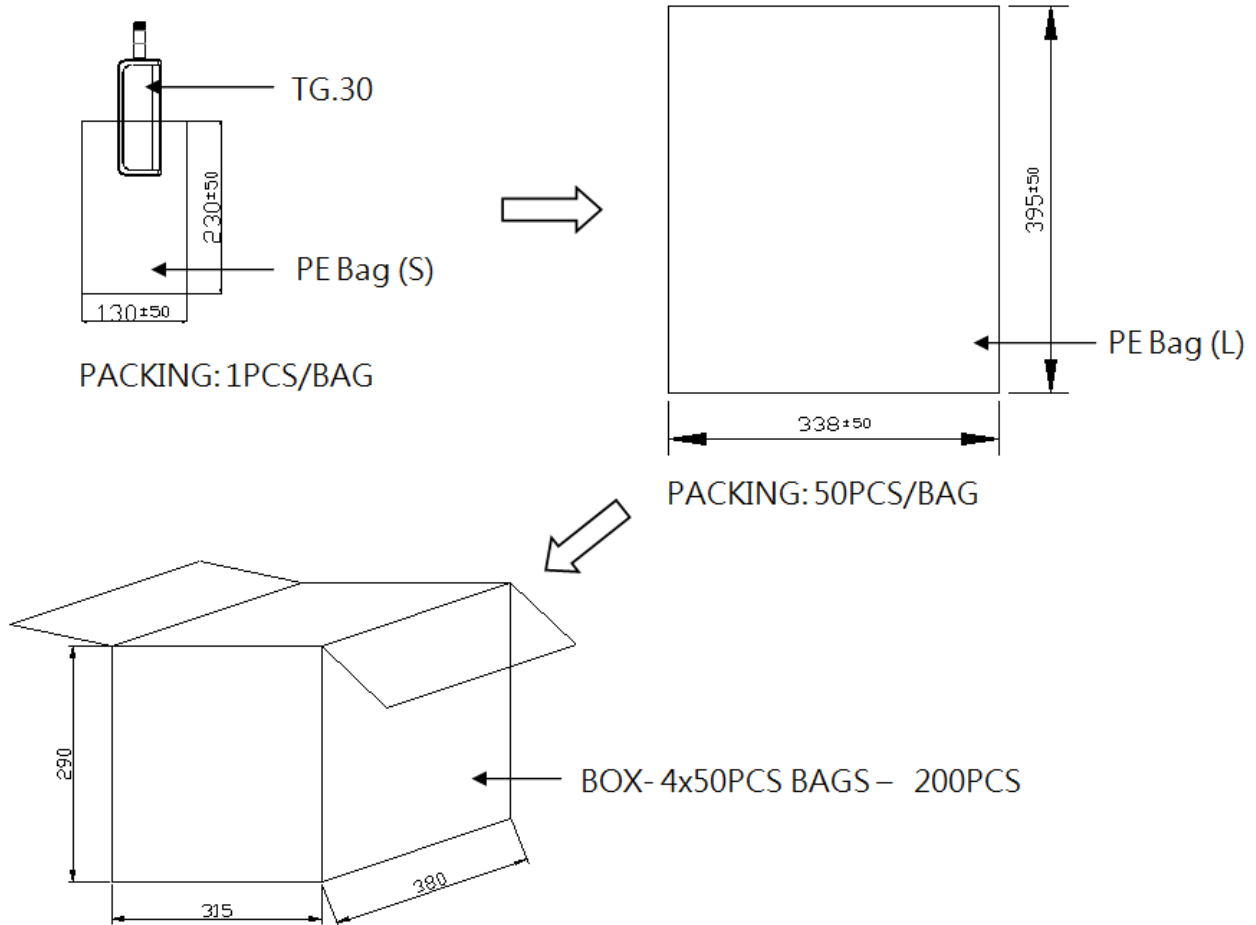

Taoglas makes no warranties based on the accuracy or completeness of the contents of this document and reserves the right to make changes to specifications and product descriptions at any time without notice. Taoglas reserves all rights to this document and the information contained herein. Reproduction, use or disclosure to third parties without express permission is strictly prohibited. Copyright © 2012, Taoglas Ltd.