

EKS36-0KF0B018A

EKS/EKM36

MOTOR FEEDBACK SYSTEMS ROTARY HIPERFACE DSL®

SICK
Sensor Intelligence.

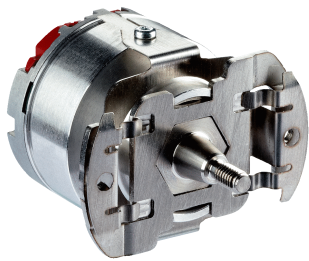

Illustration may differ

Ordering information

Type	Part no.
EKS36-0KF0B018A	1084229

Other models and accessories → www.sick.com/EKS_EKM36

Detailed technical data

Performance

Resolution per revolution	18 bit
Number of the absolute ascertainable revolutions	1
Measuring step per revolution	262,144
Signal noise (σ)	± 5 ¹⁾
Error limits positional values integral non-linearity in angular seconds	± 80
Error limits positional values differential non-linearity in angular seconds	± 40
Max. speed when switching on and resetting the motor feedback system	$\leq 6,000 \text{ min}^{-1}$
Available memory area	8,192 Byte

¹⁾ See diagrams 1 and 2.

Interfaces

Type of code for the absolute value	Binary
Code sequence	Increasing, when turning the shaft For clockwise rotation, looking in direction "A" (see dimensional drawing)
Communication interface	HIPERFACE DSL®
Initialization time	Max. 500 ms ¹⁾
Measurement external temperature resistance	32 bit value, without prefix (1 Ω) 0 ... 209.600 Ω At $-40 \text{ }^\circ\text{C}$... $+160 \text{ }^\circ\text{C}$: NTC $+2\text{K}$; PTC $+3\text{K}$
Available memory area	8,192 Byte

¹⁾ From reaching a permitted operating voltage.

Electrical data

Supply voltage range	7 V ... 12 V
Warm-up time voltage ramp	Max. 180 ms ¹⁾
Operating current	Max. 150 mA (see diagram 3) ²⁾
Operating power consumption (no load)	$\leq 150 \text{ mA}$

¹⁾ Duration of voltage ramp between 0 and 7.0 V.

²⁾ Current rating applies when using interface circuit suggestions as shown in HIPERFACE DSL® manual (8017595).

Output frequency for the digital position value	0 kHz ... 75 kHz
--	------------------

¹⁾ Duration of voltage ramp between 0 and 7.0 V.

²⁾ Current rating applies when using interface circuit suggestions as shown in HIPERFACE DSL® manual (8017595).

Mechanical data

Shaft version	Tapered shaft
Flange type/stator coupling	Stator coupling
Dimensions	See dimensional drawing
Weight	0.1 kg
Moment of inertia of the rotor	4.5 gcm ²
Operating speed	12,000 U/min
Operating torque	0.2 Ncm
Start up torque	0.3 Ncm
Permissible shaft movement, radial static, dynamic	± 0.1 mm, ± 0.05 mm
Permissible shaft movement, axial static, dynamic	± 0.1 mm
Life of ball bearings	3.6 x 10 ⁹ revolutions
Connection type	Connector, 4-pin

Ambient data

Operating temperature range	-20 °C ... +115 °C ¹⁾
Storage temperature range	-40 °C ... +125 °C
Resistance to shocks	100 g, 6 ms (according to EN 60068-2-27)
Frequency range of resistance to vibrations	50 g, 10 Hz ... 2,000 Hz (EN 60068-2-6)
EMC	According to EN 61000-6-2, EN 61000-6-4 and IEC 61326-3 ²⁾
Enclosure rating	IP50, with mating connector inserted and closed cover (acc. to EN 60529-1) ³⁾

¹⁾ Given typical thermal connection between motor flange and encoder stator coupling. The max. internal sensor temperature may not exceed 125 °C.

²⁾ The EMC according to the standards quoted is achieved when the motor feedback system is mounted in an electrically conductive housing, which is connected to the central earthing point of the motor controller via a cable screen. The GND (0V) connection of the supply voltage is also grounded here. If other screening concepts are used, users must perform their own tests.

³⁾ With mating connector inserted and closed cover.

Classifications

ECl@ss 5.0	27270590
ECl@ss 5.1.4	27270590
ECl@ss 6.0	27270590
ECl@ss 6.2	27270590
ECl@ss 7.0	27270590
ECl@ss 8.0	27270590
ECl@ss 8.1	27270590
ECl@ss 9.0	27270590
ETIM 5.0	EC001486
ETIM 6.0	EC001486
UNSPSC 16.0901	41112113

Dimensional drawing (Dimensions in mm (inch))

EKx36-xKF0B0xxA

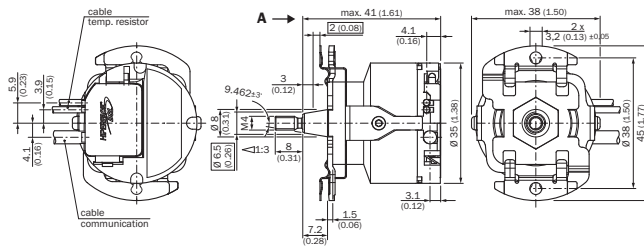

Proposed fitting

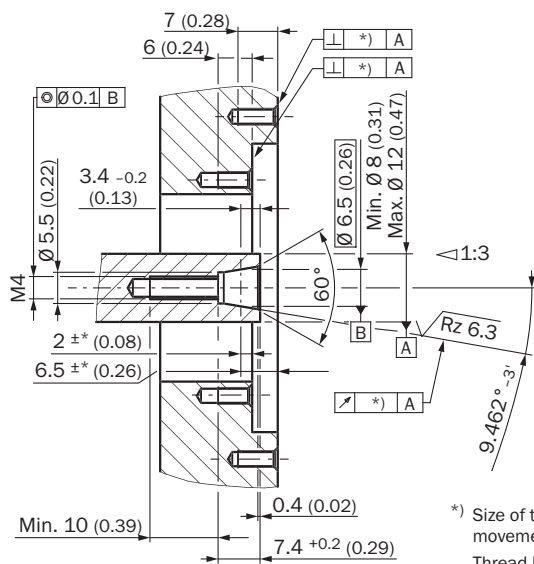

*) Size of tolerance reduce the allowed movement of the shaft, see data sheet.
Thread holes according DIN 13 with counterbore according DIN 76 min. 1.05 x diameter of thread.

- ① Nominal position
- ② The size of the tolerance reduces the permissible wave movement, see data sheet
- ③ Threaded holes in accordance with DIN 13 with recesses in accordance with DIN 76 min. 1.05 x thread diameter

PIN assignment

Pin assignment supply/communication EKx36-xKF0B0xxA

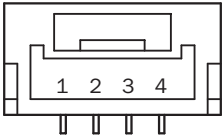

Integrated in the motor cable = J, K

PIN	Signal	Explanation
1		not connected
2	+U _{DSL} /DSL+	Power supply/DSL-Data
3	GND/DSL-	Ground connection/DSL-Data
4	housing	cable shield

Recommended outer diameter of stranded cable: 4 mm +0/-0.3 mm
 Recommended mating connector: JST (GHR-04V-S)

Diagram

Diagram 1

Position noise ["]

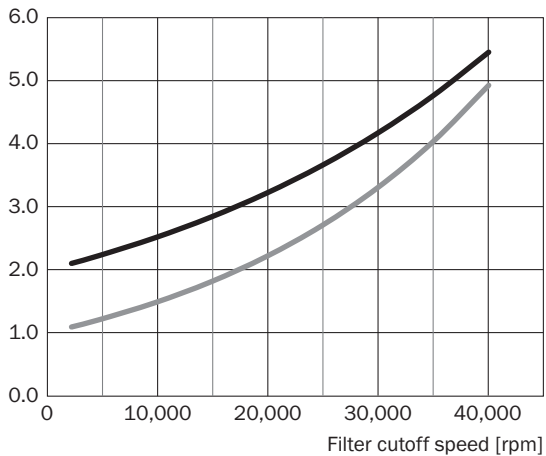

— 18 Bit
 — 20 Bit

Signal noise is measured as 1 standard deviation (σ) of the value distribution. Position filter cutoff speed is set by resource 10Ah, see page 11.

Diagram 3

Typ. current consumption [A]

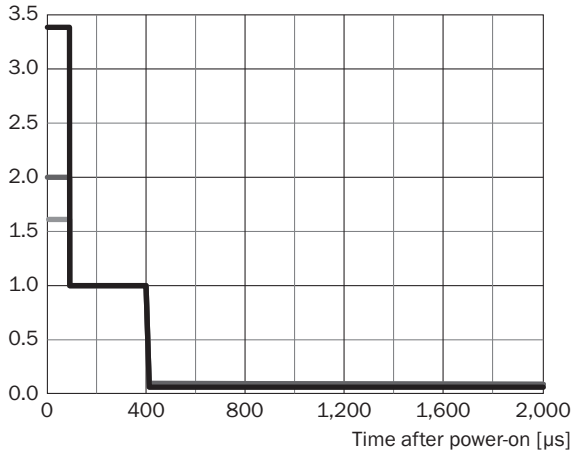

- 7 V
- 8 V
- 12 V

Diagram 2

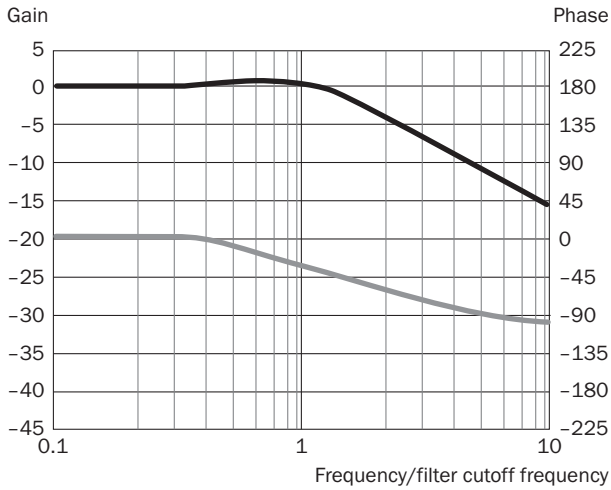



- Gain [dB]
- Phase [°]

Recommended accessories

Other models and accessories → www.sick.com/EKS_EKM36

	Brief description	Type	Part no.
Other mounting accessories			
	Mounting tools	BEF-MW-EKX36	2060224

	Brief description	Type	Part no.
Plug connectors and cables			
	Head A: cable Head B: cable Cable: HIPERFACE DSL®, drag chain use, PUR, shielded	LTG-3104-MW	6044358
	Head A: female connector, stranded cable, 4-pin, straight Head B: cable Cable: HIPERFACE DSL®, unshielded, 0.2 m	DOL-0B02-G0M2XC2	2079920
	Head A: female connector, M12, 4-pin, straight Head B: female connector, JST, 4-pin, straight Cable: HIPERFACE DSL®, shielded, 1 m	DSL-1202-G01MA	2061361
Programming and configuration tools			
	SVip® LAN programming tool for all motor feedback systems	PGT-11-S LAN	1057324
	SVip® WLAN programming tool for all motor feedback systems	PGT-11-S WLAN	1067474

SICK AT A GLANCE

SICK is one of the leading manufacturers of intelligent sensors and sensor solutions for industrial applications. A unique range of products and services creates the perfect basis for controlling processes securely and efficiently, protecting individuals from accidents and preventing damage to the environment.

We have extensive experience in a wide range of industries and understand their processes and requirements. With intelligent sensors, we can deliver exactly what our customers need. In application centers in Europe, Asia and North America, system solutions are tested and optimized in accordance with customer specifications. All this makes us a reliable supplier and development partner.

Comprehensive services complete our offering: SICK LifeTime Services provide support throughout the machine life cycle and ensure safety and productivity.

For us, that is “Sensor Intelligence.”

WORLDWIDE PRESENCE:

Contacts and other locations –www.sick.com