

Description

The EMIF06-HMC02F2 is a highly integrated array designed to suppress EMI / RFI noise for High Speed MultiMediaCard™ port filtering. The EMIF06-HMC02F2 Flip-Chip packaging means the package size is equal to the die size.

Additionally, this filter includes an ESD protection circuitry which prevents the protected device from destruction when subjected to ESD surges up to 15 kV. Compared to EMIF06-HMC01F2, the EMIF06-HMC02F2 has its ground balls connected together internally.

Features

- 6 lines low-pass-filter
- High efficiency in EMI filtering
- Very low PCB space consuming: < 4 mm²
- Lead-free package
- Very thin package: 0.65 mm
- High efficiency in ESD suppression
- High reliability offered by monolithic integration
- High reducing of parasitic elements through integration and wafer level packaging

Complies with the following standards

- IEC 61000-4-2 level 4 on external pins
 - 15 kV (air discharge)
 - 8 kV (contact discharge)
- MIL STD 883E - Method 3015-6 Class 3

Applications

- High Speed MultiMediaCard™

Figure 1. Pin configuration (ball side)

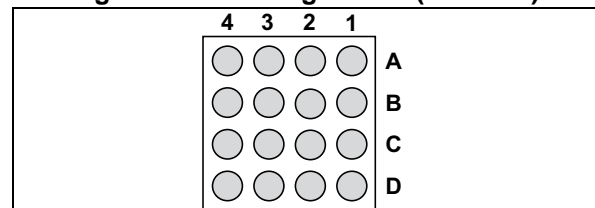

Figure 2. Basic cell configuration

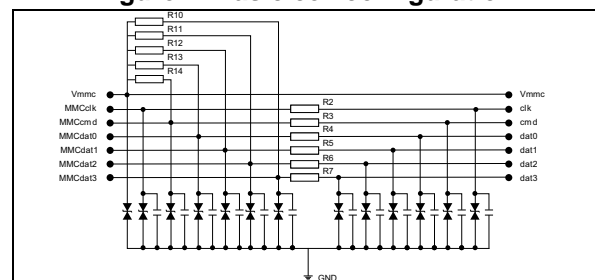

Table 1. Ball configuration

A1	cmd	C1	dat2
A2	clk	C2	gnd
A3	Vmmc/Vdd	C3	MMCdat1
A4	MMCclk	C4	MMCdat0
B1	dat1	D1	dat3
B2	dat0	D2	gnd
B3	gnd	D3	MMCdat3
B4	MMCcmd	D4	MMCdat2

TM: IPAD is a trademark of STMicroelectronics.

1 Electrical characteristics

Table 2. Absolute maximum ratings ($T_{amb} = 25\text{ }^{\circ}\text{C}$)

Symbol	Parameter and test conditions	Value	Unit
V_{PP}	Internal pins (A4, B4, C3, C4, D3, D4):		
	ESD discharge IEC61000-4-2, air discharge	2	kV
	ESD discharge IEC61000-4-2, contact discharge	2	
	External pins (A1, A2, A3, B1, B2, C1, D1):		
ESD discharge IEC61000-4-2, air discharge	15		
	ESD discharge IEC61000-4-2, contact discharge	8	
T_j	Maximum junction temperature	125	$^{\circ}\text{C}$
T_{op}	Operating temperature range	- 40 to + 85	$^{\circ}\text{C}$
T_{stg}	Storage temperature range	- 55 to + 150	$^{\circ}\text{C}$

Figure 3. Electrical characteristics (definitions)

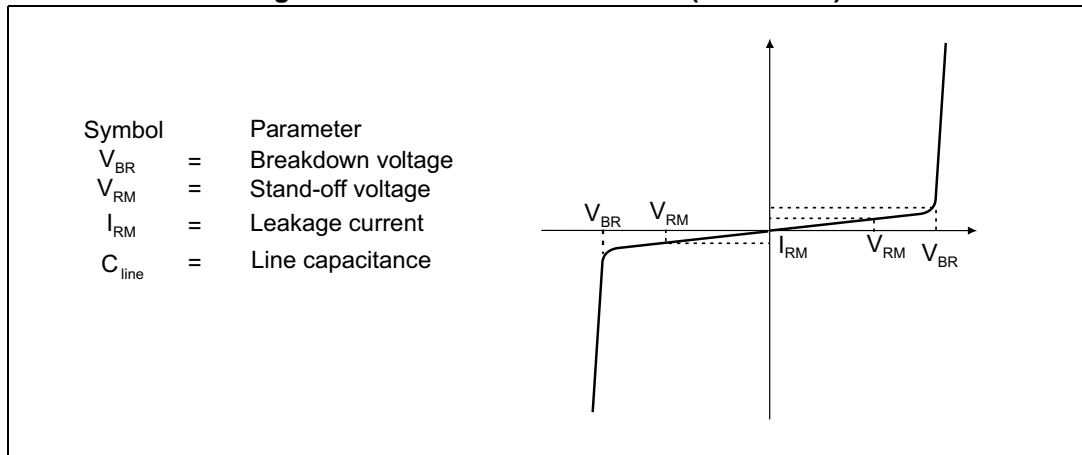

Table 3. Electrical characteristics ($T_{amb} = 25\text{ }^{\circ}\text{C}$)

Symbol	Test conditions	Tolerance	Min.	Typ.	Max.	Unit
V_{BR}	$I_R = 1\text{ mA}$		6			V
I_{RM}	$V_{RM} = 3\text{ V}$				0.1	μA
C_{line}	$V_{BIAS} = 0\text{ V}$, $V_{OSC} = 30\text{ mV}$, $f = 1\text{ MHz}$				20	pF
$R_2, R_3, R_4,$ R_5, R_6, R_7	$I = 50\text{ mA}$	$\pm 20\%$		50		Ω
$R_{10}, R_{11},$ R_{12}, R_{13}	$I = 50\text{ }\mu\text{A}$	$\pm 30\%$		75		k Ω
R_{14}	$I = 200\text{ }\mu\text{A}$	$\pm 30\%$		7		k Ω

Figure 4. Attenuation versus frequency

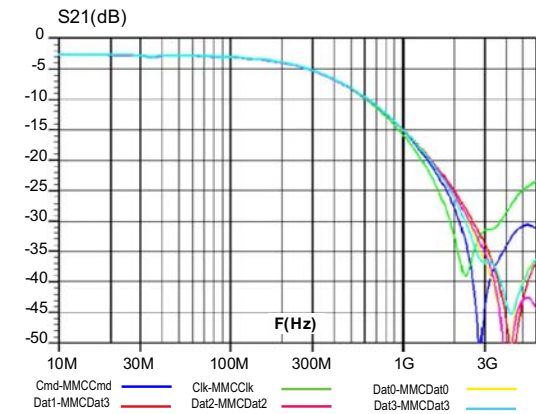

Figure 5. Analog crosstalk versus frequency

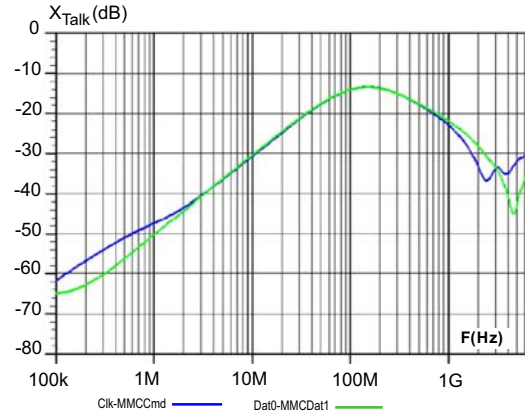

Figure 6. ESD response to IEC61000-4-2 (+8 kV contact discharge)

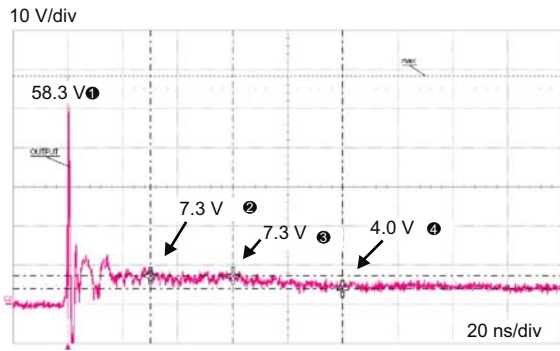

Figure 7. ESD response to IEC61000-4-2 (-8 kV contact discharge)

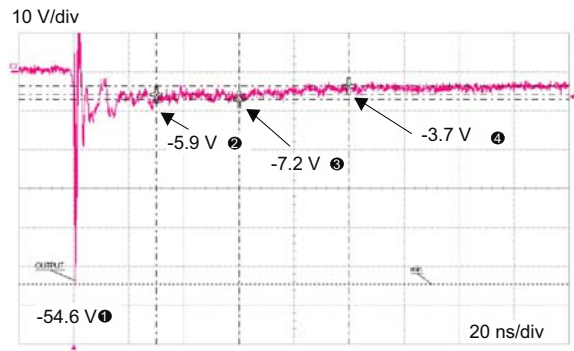
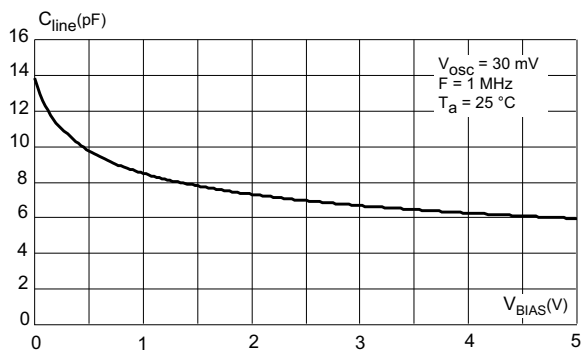

Figure 8. Junction capacitance versus reverse voltage applied (typical values)



2 Package information

In order to meet environmental requirements, ST offers these devices in different grades of ECOPACK® packages, depending on their level of environmental compliance. ECOPACK® specifications, grade definitions and product status are available at: www.st.com. ECOPACK® is an ST trademark.

2.1 Flip-Chip package information

Figure 9. Flip-Chip package outline

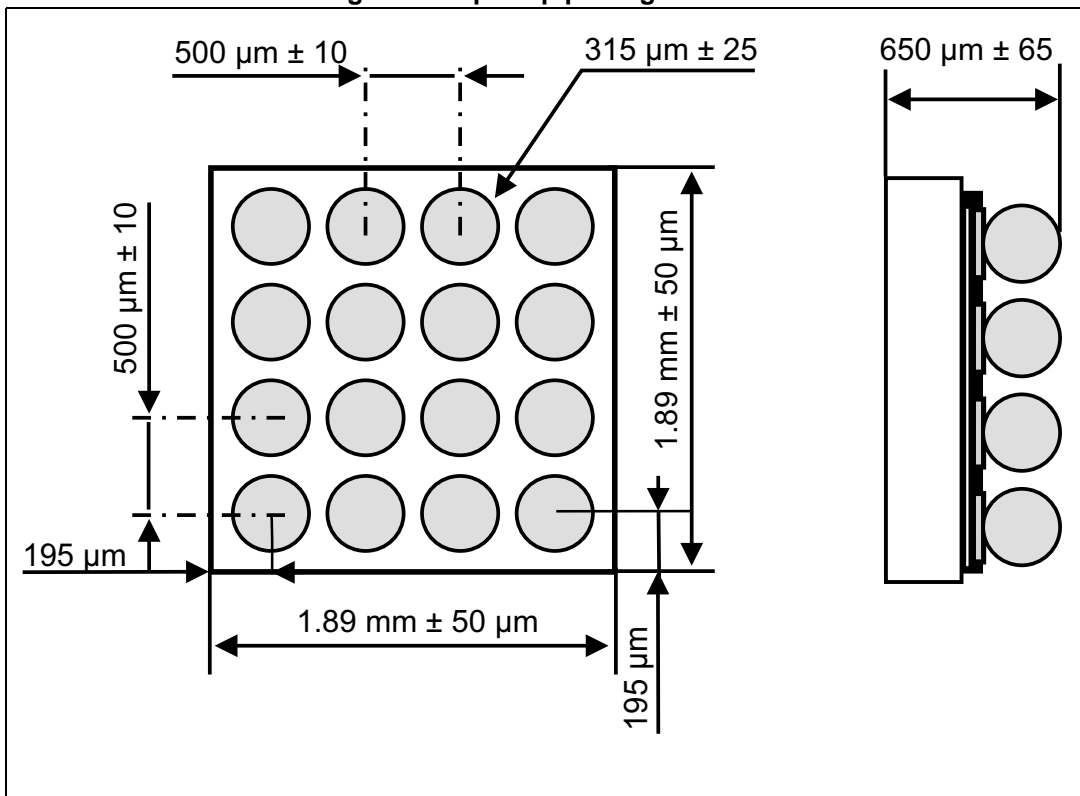

2.2 Packing information

Figure 10. Tape and reel outline

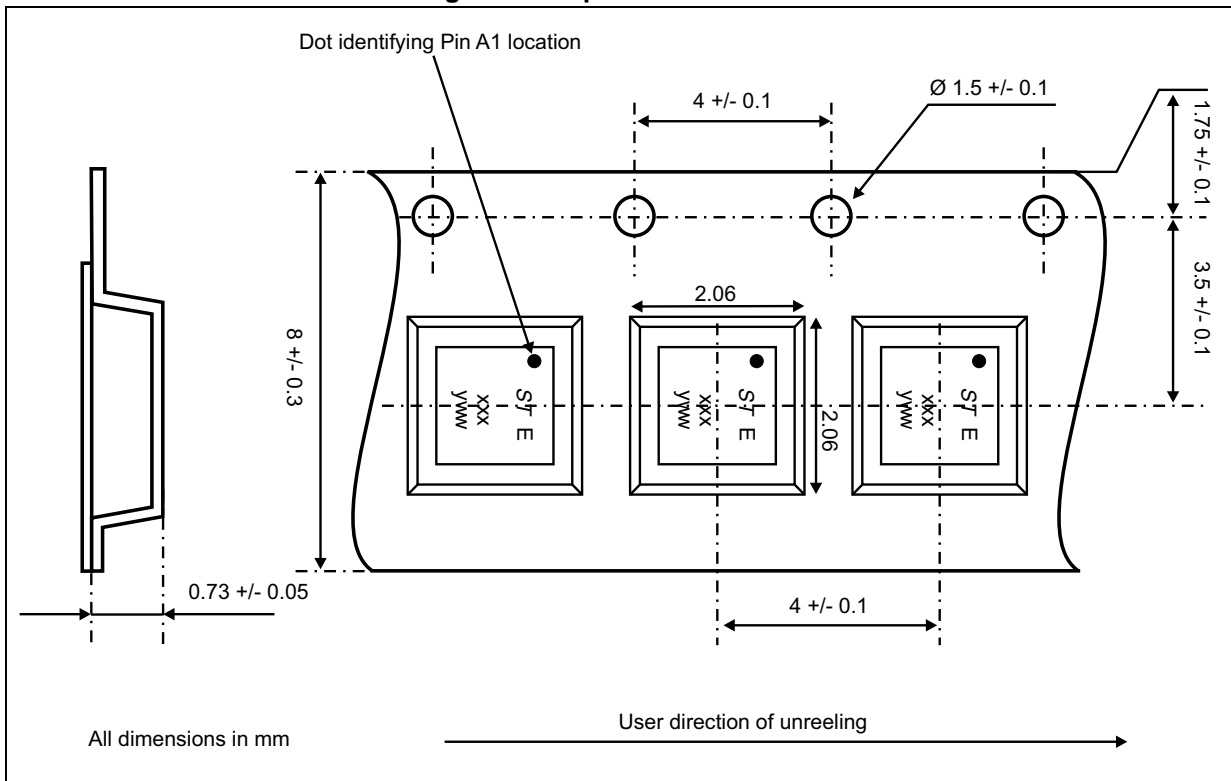

Figure 11. Footprint

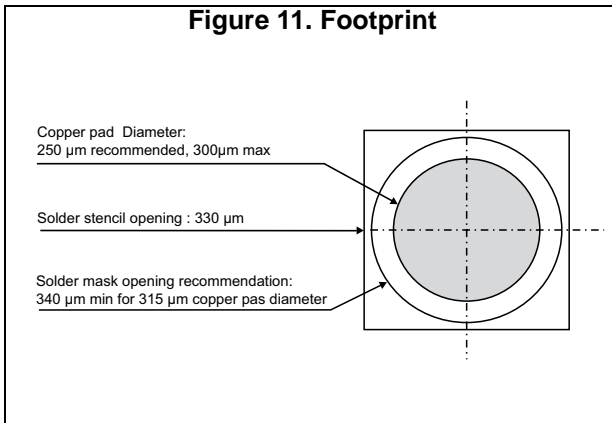
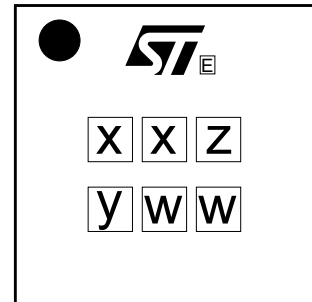

Figure 12. Marking

Dot, ST logo
 xx = marking
 z = packaging location
 yww = datecode
 (y = year
 ww = week)



3 Ordering information

Figure 13. Ordering information scheme

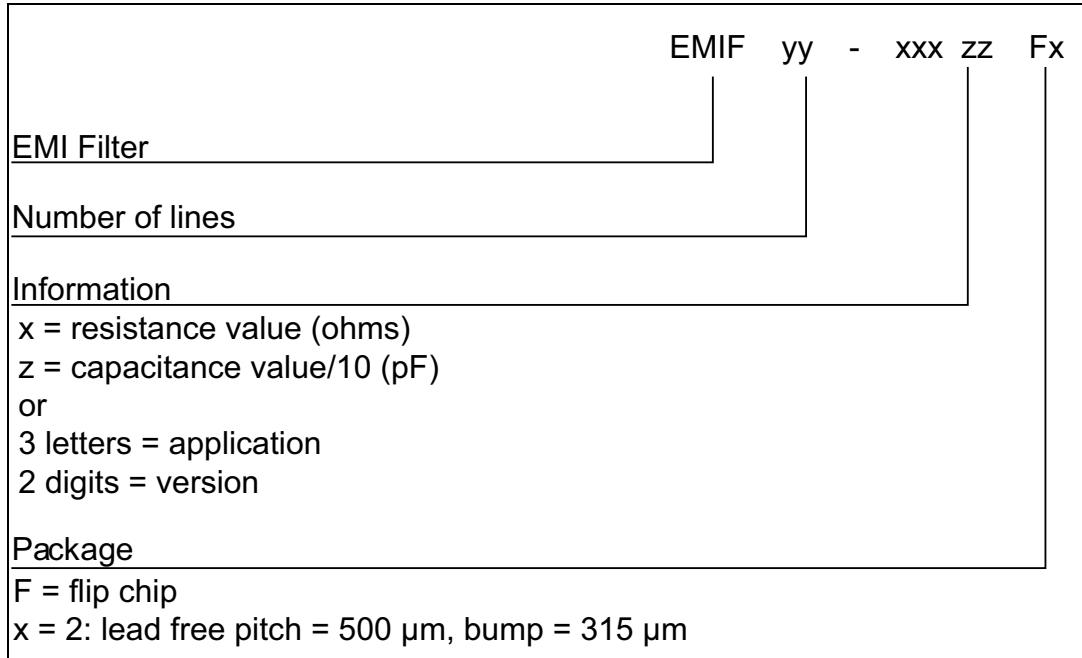

Table 4. Ordering information

Order code	Marking	Package	Weight	Base qty	Delivery mode
EMIF06-HMC02F2	LK	Flip chip	5.3 mg	5000	Tape and reel 7"

Note: More information are available in the application notes:
 AN1235: "Flip chip: Package description and recommendations for use"

4 Revision history

Table 5. Document revision history

Date	Revision	Changes
02-Mar-2016	1	Initial release.

IMPORTANT NOTICE – PLEASE READ CAREFULLY

STMicroelectronics NV and its subsidiaries ("ST") reserve the right to make changes, corrections, enhancements, modifications, and improvements to ST products and/or to this document at any time without notice. Purchasers should obtain the latest relevant information on ST products before placing orders. ST products are sold pursuant to ST's terms and conditions of sale in place at the time of order acknowledgement.

Purchasers are solely responsible for the choice, selection, and use of ST products and ST assumes no liability for application assistance or the design of Purchasers' products.

No license, express or implied, to any intellectual property right is granted by ST herein.

Resale of ST products with provisions different from the information set forth herein shall void any warranty granted by ST for such product.

ST and the ST logo are trademarks of ST. All other product or service names are the property of their respective owners.

Information in this document supersedes and replaces information previously supplied in any prior versions of this document.

© 2016 STMicroelectronics – All rights reserved

